

▼
Creative Passion

Koino[®]

www.koino.com

COUNTER & TIMER



Quick Selection Guide

Category		Front Panel Size	Pin Type	Mounting Type	Model No.	
Counter/Timer Dual use		72X72	–	Flush mounting type	KCT-72	
		72X36	–	Flush mounting type	KCT-DP	
Counter		48X48	8 pin	Flush mounting type	KPC-48	
Digital Timer		48X48	8 pin	Flush mounting type	KDT-48	
Analog Multi Timer		48X48	8 pin	Flush mounting type	KTM-AM8	
		48X48	11 pin	Flush mounting type	KTM-AM11	
Timer	IC Timer	Basic	50X62	8 pin	Surface mounting type	KTM-1
			50X62	8 pin	Flush mounting type	KTM-2
	Twin Timer	50X62	8 pin	Surface mounting type	KTM-1T	
		50X62	8 pin	Flush mounting type	KTM-2T	
	48 Timer	48X48	8 pin	Flush mounting type	KTM-1F	
	Mini Multi Timer	36X40	8 pin	Flush mounting type	KTM-1S	
	Timing Relay	21X27.5	14 pin(8 pin for 2P model)	–	KTM-3M	
	Flicker	50X62	8 pin	Surface mounting type	KFR-1	
49X62		8 pin	Flush mounting type	KFR-2		
Display Only		72X36	–	Flush mounting type	KD-DPS	

KCT-72 COUNTER/TIMER

CONTROL
COMPONENTSSQUARE
LIGHTTOWER
LIGHTMICRO
SWITCHFOOT
SWITCHLIMIT
SWITCHPOWER
SWITCHHOIST
SWITCHCAM
SWITCH

BUZZER

PHOTO
SENSORPROXIMITY
SENSORFLOATLESS
LEVEL SWITCHTIMER &
COUNTER

RELAY

SOCKETS

TERMINAL
BLOCKCONTROL
BOXPID TEMP.
CONTROLLER

Specification

Display	Red LED(6 digits)	
Voltage	90~240VAC(50/60Hz)	
Power Consumption	3.5VA	
Returning Time	Power reset: 500ms/ Reset button: 20ms	
Input	non-voltage input	
Counting	30CPS/2,000CPS	
External DC Source	DC12V \pm 10% 50mA Max.	
Memory Back Up	10 years	
Ratings	250VAC 2.5A, 30VDC 2A(resistive load)	
Output	Relay output: 1C SPST NPN Transistor open collector output(30VDC, 50mA Max.)	
Output relay durability	Mechanical: 10,000,000 operations Electrical: 200,000 operations	
Insulation resistance	min. 100M Ω (DC500V)	
Dielectric strength	50/60Hz AC2,000V for 1 minute	
Anti-noise resistance	Square wave(pulse width 1 μ s) by noise simulator \pm 2KV	
Vibration	Resistance	10~55Hz at double amplitude: 0.75mm(X,Y,Z directions) for 1hr
	Malfunction	10~55Hz at double amplitude: 0.5mm(X,Y,Z directions) for 10 min.
Shock	Resistance	30G, at 3 axis, 3 times
	Malfunction	10G, at 3 axis, 3 times
Ambient Temperature	-10~+55 $^{\circ}$ C (not freezing condition)	
Ambient Humidity	35~85% RH	
Material	ABS	
Weight	395g	

Function selection

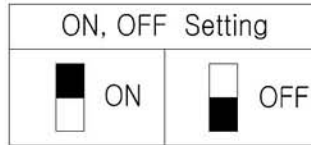
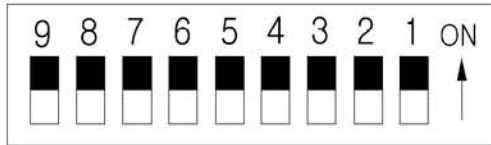















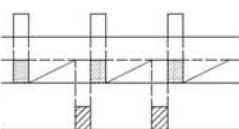

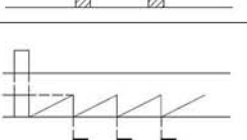



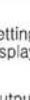
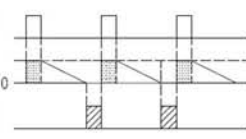







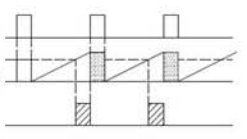
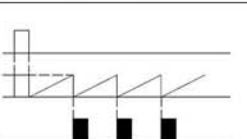
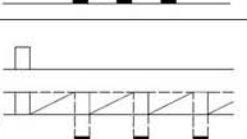
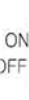











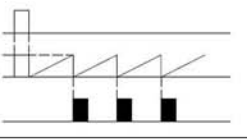
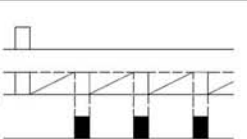
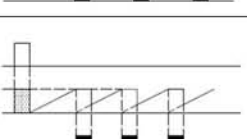







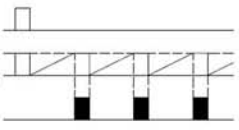





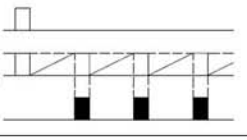
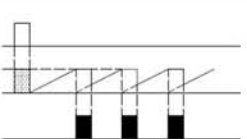





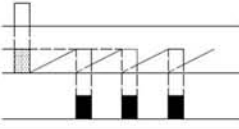
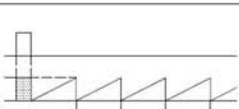





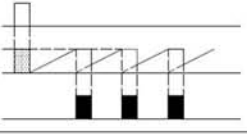





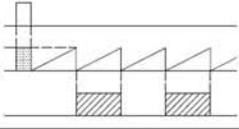
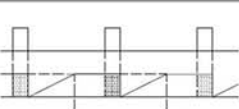











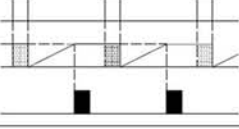













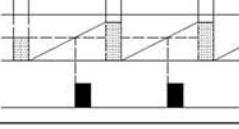





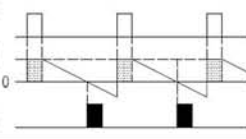

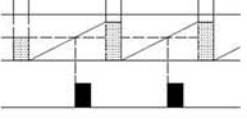

DIP S/W #	COUNTER	TIMER
1	ON: No memory backup / OFF: Memory backup	
4,3,2,	Output mode selection	
6,5	Input mode selection	Time setting range
7	Counting speed selection ON:2,000cps/OFF:30cps	
8	ON: Addition mode / OFF: Subtraction mode	ON: Addition mode / OFF: Subtraction mode
9	ON	OFF

Counter input selection

Position	UP mode	Position	DOWN mode
ON OFF 		ON OFF 	
ON OFF 		ON OFF 	
ON OFF 		ON OFF 	
ON OFF 		ON OFF 	

Counter input selection

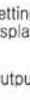
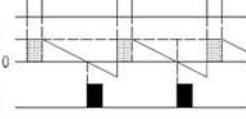
 : One shot output(0.05~5sec Setting)
  : Hold (Hold output)
  : Non-Display

Position	UP mode	Position	DOWN mode
ON OFF     	Reset  Setting Display  Output 	ON OFF     	Reset  Setting Display  Output 
ON OFF     	Reset  Setting Display  Output 	ON OFF     	Reset  Setting Display  Output 
ON OFF     	Reset  Setting Display  Output 	ON OFF     	Reset  Setting Display  Output 
ON OFF     	Reset  Setting Display  Output 	ON OFF     	Reset  Setting Display  Output 
ON OFF     	Reset  Setting Display  Output 	ON OFF     	Reset  Setting Display  Output 
ON OFF     	Reset  Setting Display  Output 	ON OFF     	Reset  Setting Display  Output 
ON OFF     	Reset  Setting Display  Output 	ON OFF     	Reset  Setting Display  Output 
ON OFF     	Reset  Setting Display  Output 	ON OFF     	Reset  Setting Display  Output 

CONTROL COMPONENTS

SQUARE LIGHT

TOWER LIGHT

MICRO SWITCH

FOOT SWITCH

LIMIT SWITCH

POWER SWITCH

HOIST SWITCH

CAM SWITCH

BUZZER

PHOTO SENSOR

PROXIMITY SENSOR

FLOATLESS LEVEL SWITCH

TIMER & COUNTER

RELAY

SOCKETS







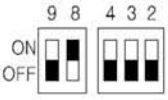
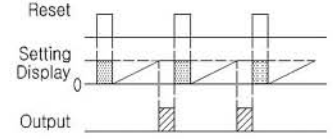
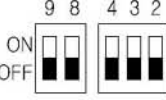
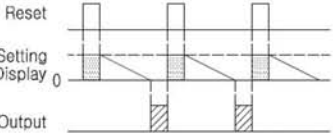
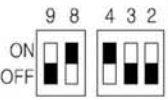
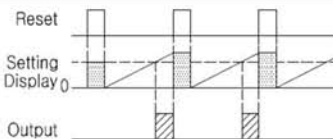
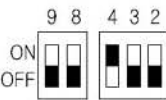
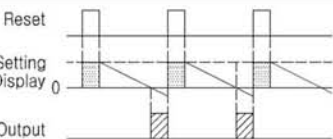
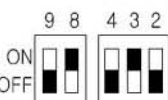
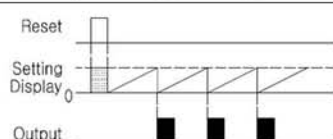
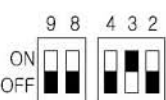
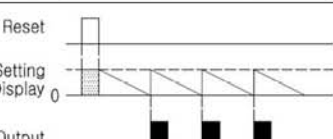
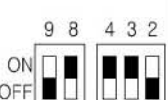
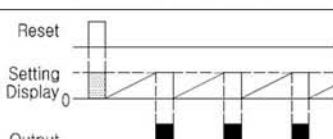
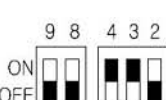
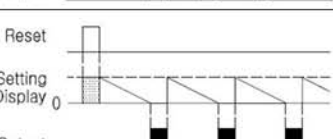
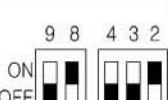
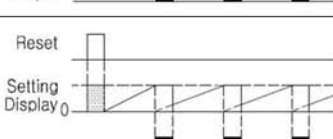
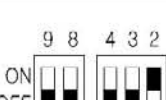
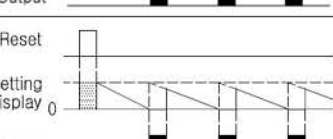
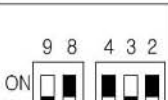
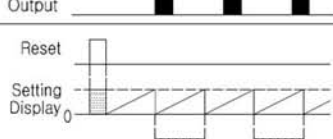
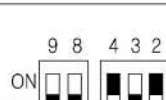
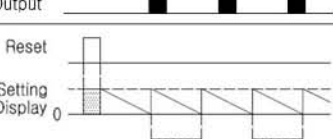
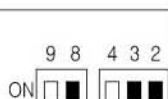

TERMINAL BLOCK

CONTROL BOX

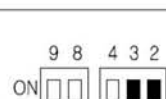
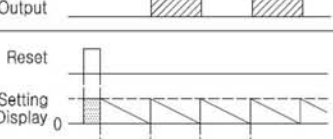
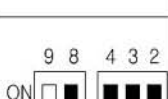
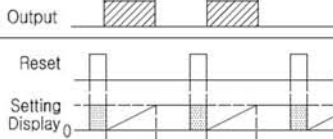
PID TEMP. CONTROLLER

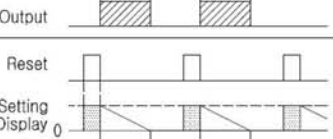
Counter output selection (continued)

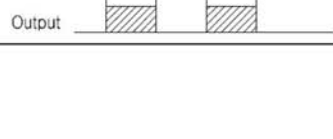
 : One shot output(0.05~5sec Setting)
  : Hold (Hold output)
  : Non-Display

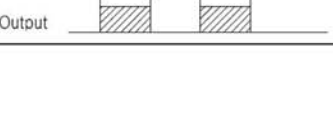
Position	UP mode	Position	DOWN mode
			
			
			
			
			
			
			
			
			

Time range selection

Position	UP mode	Position	DOWN mode
9 7 6 5 ON [ON] [ON] [ON] [ON] OFF [OFF] [OFF] [OFF] [OFF]	99999.9 sec	9 7 6 5 ON [ON] [ON] [ON] [ON] OFF [OFF] [OFF] [OFF] [OFF]	99,999.9 hours
9 7 6 5 ON [ON] [ON] [ON] [ON] OFF [OFF] [OFF] [OFF] [OFF]	999,999 sec	9 7 6 5 ON [ON] [ON] [ON] [ON] OFF [OFF] [OFF] [OFF] [OFF]	9,999 min 59 sec
9 7 6 5 ON [ON] [ON] [ON] [ON] OFF [OFF] [OFF] [OFF] [OFF]	99,999.9 min	9 7 6 5 ON [ON] [ON] [ON] [ON] OFF [OFF] [OFF] [OFF] [OFF]	9,999 hours 59 min
9 7 6 5 ON [ON] [ON] [ON] [ON] OFF [OFF] [OFF] [OFF] [OFF]	999,999 min	9 7 6 5 ON [ON] [ON] [ON] [ON] OFF [OFF] [OFF] [OFF] [OFF]	99 hours 59 min 59 sec

Wiring diagram

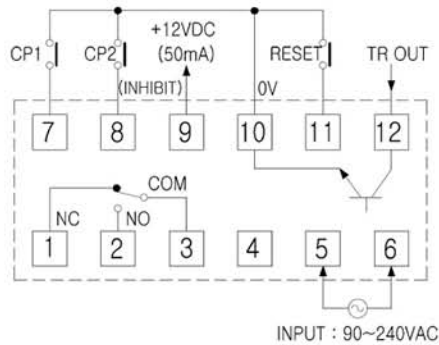

Dimensions

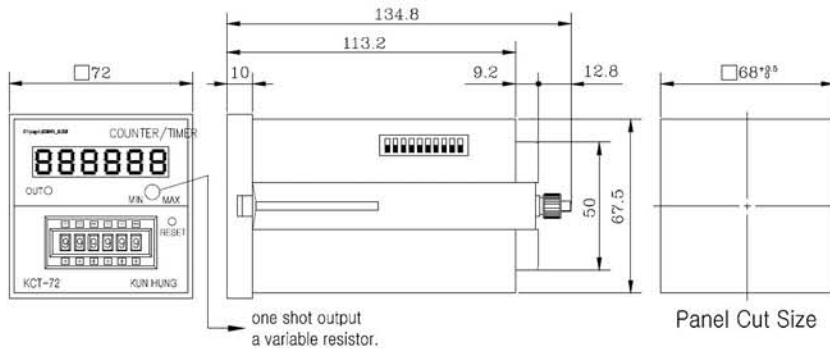

CONTROL COMPONENTS

SQUARE LIGHT

TOWER LIGHT

MICRO SWITCH

FOOT SWITCH

LIMIT SWITCH

POWER SWITCH

HOIST SWITCH

CAM SWITCH

BUZZER

PHOTO SENSOR

PROXIMITY SENSOR

FLOATLESS LEVEL SWITCH

TIMER & COUNTER

RELAY

SOCKETS

TERMINAL BLOCK

CONTROL BOX

PID TEMP. CONTROLLER

Input Diagram

**Non-contact input
(proximity sensor or photo sensor)**

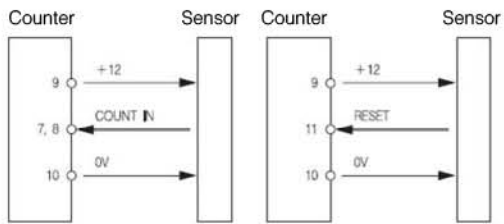

**Contact input
(Limit switch or micro switch)**

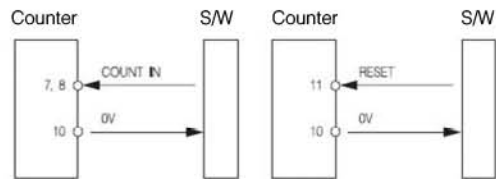

KCT-DP COUNTER/TIMER

CONTROL
COMPONENTSSQUARE
LIGHTTOWER
LIGHTMICRO
SWITCHFOOT
SWITCHLIMIT
SWITCHPOWER
SWITCHHOIST
SWITCHCAM
SWITCH

BUZZER

PHOTO
SENSORPROXIMITY
SENSORFLOATLESS
LEVEL SWITCHTIMER &
COUNTER

RELAY

SOCKETS

TERMINAL
BLOCKCONTROL
BOXPID TEMP.
CONTROLLER

Specification

Display	Red LED(6 digits)	
Voltage	90~240VAC(50/60Hz)	
Power Consumption	1.5VA	
Returning Time	Power reset: 500ms/ Reset button: 20ms	
Input	non-voltage input	
Counting	30CPS/2,000CPS	
External DC Source	DC12V \pm 10% 50mA Max.	
Memory Back Up	10 years	
Insulation resistance	min. 100M Ω (DC500V)	
Dielectric strength	50/60Hz AC2,000V for 1 minute	
Anti-noise resistance	Square wave (pulse width 1 μ s) by noise simulator \pm 2KV	
Vibration	Resistance	10~55Hz at double amplitude: 0.75mm(X,Y,Z directions) for 1 hour
	Malfunction	10~55Hz at double amplitude: 0.5mm(X,Y,Z directions) for 10 min.
Shock	Resistance	30G, at 3 axis, 3 times
	Malfunction	10G, at 3 axis, 3 times
Ambient Temperature	-10~+55°C (not freezing condition)	
Ambient Humidity	35~85% RH	
Material	ABS	
Weight	100g	

Function selection

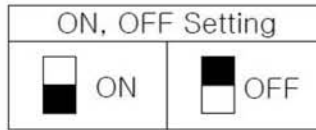
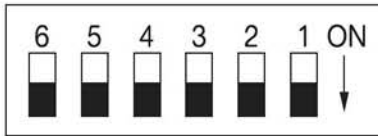





DIP S/W #	COUNTER	TIMER
1	ON: No memory backup / OFF: Memory backup	
2	ON	OFF
3	ON: Addition mode / OFF: Subtraction mode	
4	Counting speed selection ON:2,000cps/OFF:30cps	Time setting range
5	Counter input mode	
6		

Input mode (counter)

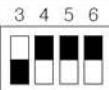
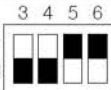
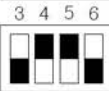
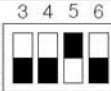
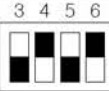
Position	UP mode	Position	DOWN mode

Time range selection

Position	UP mode	Position	DOWN mode
3 4 5 6 OFF ON 	99999.9 sec	3 4 5 6 OFF ON 	99,999.9 hours
3 4 5 6 OFF ON 	999,999 sec	3 4 5 6 OFF ON 	9,999 min 59 sec
3 4 5 6 OFF ON 	99,999.9 min	3 4 5 6 OFF ON 	9,999 hours 59 min
3 4 5 6 OFF ON 	999,999 min	3 4 5 6 OFF ON 	99 hours 59 min 59 sec

Wiring diagram

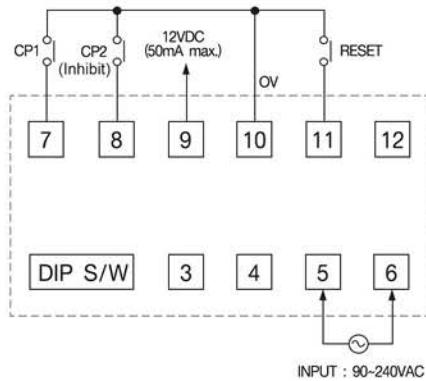

CONTROL COMPONENTS

SQUARE LIGHT

TOWER LIGHT

MICRO SWITCH

FOOT SWITCH

LIMIT SWITCH

POWER SWITCH

HOIST SWITCH

CAM SWITCH

BUZZER

PHOTO SENSOR

PROXIMITY SENSOR

FLOATLESS LEVEL SWITCH

TIMER & COUNTER

RELAY

SOCKETS

TERMINAL BLOCK

CONTROL BOX

PID TEMP. CONTROLLER

Signal input diagram

- Solid State Input (Proximity Switch, Beam Switch)

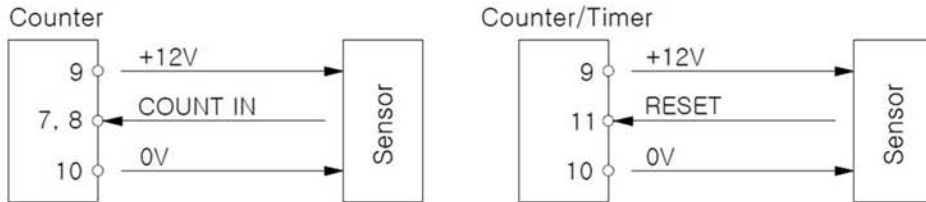

- Contact Input (Limits Switch, Micro Switch)

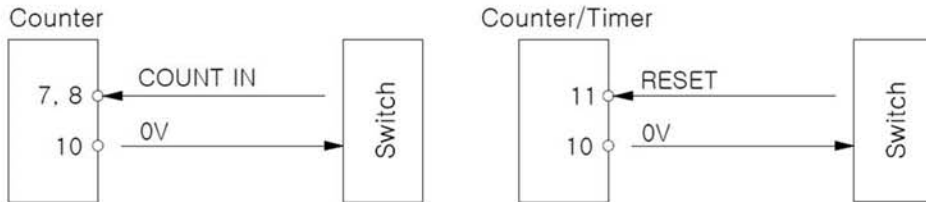

Dimensions

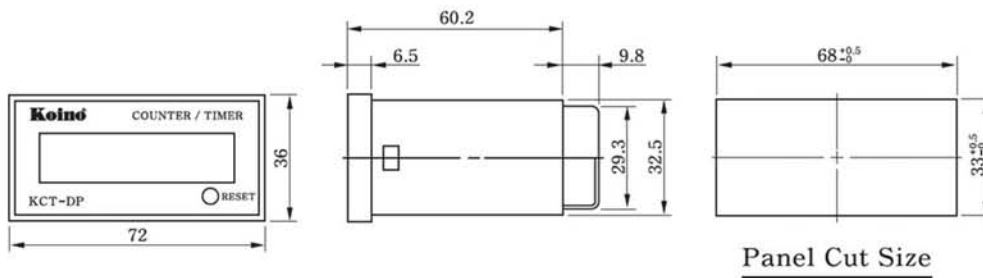

KPC-48 COUNTER

CONTROL
COMPONENTSSQUARE
LIGHTTOWER
LIGHTMICRO
SWITCHFOOT
SWITCHLIMIT
SWITCHPOWER
SWITCHHOIST
SWITCHCAM
SWITCH

BUZZER

PHOTO
SENSORPROXIMITY
SENSORFLOATLESS
LEVEL SWITCHTIMER &
COUNTER

RELAY

SOCKETS

TERMINAL
BLOCKCONTROL
BOXPID TEMP.
CONTROLLER

Specification

Display	Red LED(4 digits)	
Wiring	8 pin Socket: KH-KTS-8, KH-RS-R8, KH-MR-8	
Voltage	90~240VAC(50/60Hz)	
Power Consumption	2.2VA	
Returning Time	Power reset: 500ms/ Gate: 20ms	
Output Ratings	250VAC 2A, 30VDC 2A(Resistive Load)	
Output Relay Durability	Mechanical: 10,000,000 operations Electrical: 200,000 operations (Resistive Load)	
Insulation resistance	min. 100MΩ(DC500V)	
Dielectric strength	50/60Hz AC2,000V for 1 minute	
Anti-noise resistance	Square wave (pulse width 1 μs) by noise simulator ± 2KV	
Vibration	Resistance	10~55Hz at double amplitude: 0.75mm(X,Y,Z directions) for 1 hour
	Malfunction	10~55Hz at double amplitude: 0.5mm(X,Y,Z directions) for 10 min.
Shock	Resistance	30G, at 3 axis, 3 times
	Malfunction	10G, at 3 axis, 3 times
Accuracy	± 0.01%	
Protection	IP50	
Ambient Temperature	-10~+55°C (not freezing condition)	
Ambient Humidity	35~85% RH	
Material	PC	
Weight	96 g	

Function selection

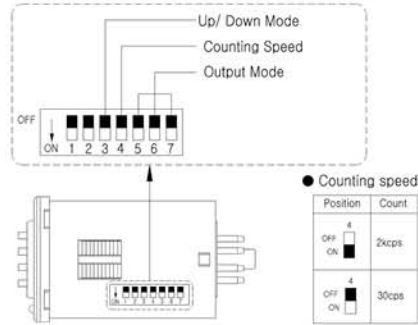

Wiring diagram

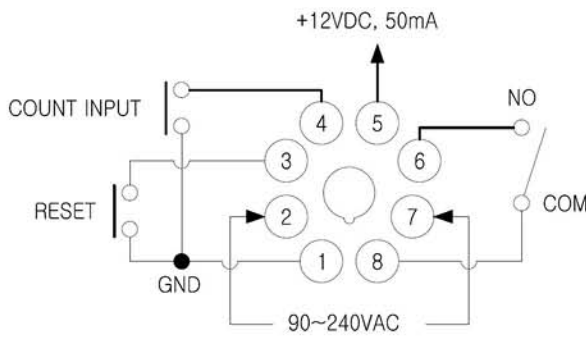

Signal input diagram

Solid state input

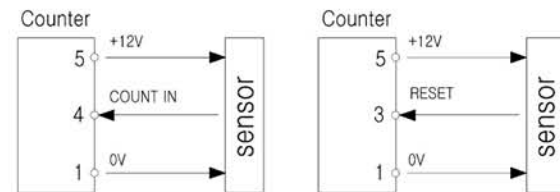

Contact input

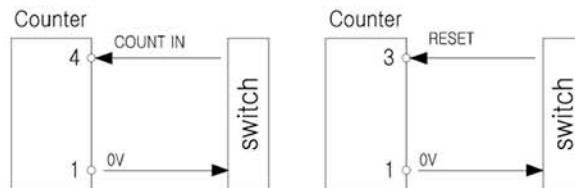

Counter output selection (continued)

■ : One shot output(0.05~5sec Setting) ▨ : Hold (Hold output) ▩ : Non-Display

Position	UP mode	Position	DOWN mode
3 5 6 7 OFF ON 		3 5 6 7 OFF ON 	
9 8 4 3 2 ON OFF 		9 8 4 3 2 ON OFF 	
9 8 4 3 2 ON OFF 		9 8 4 3 2 ON OFF 	
9 8 4 3 2 ON OFF 		9 8 4 3 2 ON OFF 	
3 5 6 7 OFF ON 		3 5 6 7 OFF ON 	
3 5 6 7 OFF ON 		3 5 6 7 OFF ON 	
3 5 6 7 OFF ON 		3 5 6 7 OFF ON 	
3 5 6 7 OFF ON 		3 5 6 7 OFF ON 	

CONTROL COMPONENTS

SQUARE LIGHT

TOWER LIGHT

MICRO SWITCH

FOOT SWITCH

LIMIT SWITCH

POWER SWITCH

HOIST SWITCH

CAM SWITCH

BUZZER

PHOTO SENSOR

PROXIMITY SENSOR

FLOATLESS LEVEL SWITCH

TIMER & COUNTER

RELAY

SOCKETS

TERMINAL BLOCK

CONTROL BOX

PID TEMP. CONTROLLER

Dimensions

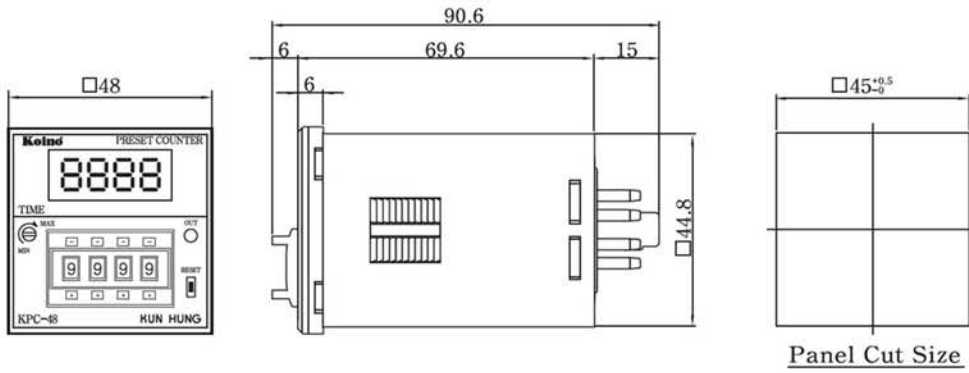

KDT-48 DIGITAL TIMER



CONTROL COMPONENTS

SQUARE LIGHT

TOWER LIGHT

MICRO SWITCH

FOOT SWITCH

LIMIT SWITCH

POWER SWITCH

HOIST SWITCH

CAM SWITCH

BUZZER

PHOTO SENSOR

PROXIMITY SENSOR

FLOATLESS LEVEL SWITCH

TIMER & COUNTER

RELAY

SOCKETS

TERMINAL BLOCK

CONTROL BOX

PID TEMP. CONTROLLER

Specification

Display	Red LED(4 digits)	
Wiring	8 pin Socket: KH-KTS-8, KH-RS-R8, KH-MR-8	
Voltage	90~240VAC(50/60Hz)	
Power Consumption	2.2VA	
Returning Time	Power reset: 500ms/ Gate: 20ms	
Output Ratings	250VAC 2A, 30VDC 2A(Resistive Load)	
Output Relay Durability	Mechanical: 10,000,000 operations Electrical: 200,000 operations(Resistive Load)	
Insulation resistance	min. 100MΩ(DC500V)	
Dielectric strength	50/60Hz AC2,000V for 1 minute	
Anti-noise resistance	Square wave(pulse width 1 μs) by noise simulator ± 2KV	
Vibration	Resistance	10~55Hz at double amplitude: 0.75mm(X,Y,Z directions) for 1 hour
	Malfunction	10~55Hz at double amplitude: 0.5mm(X,Y,Z directions) for 10 min.
Shock	Resistance	30G, at 3 axis, 3 times
	Malfunction	10G, at 3 axis, 3 times
Accuracy	± 0.01%	
Protection	IP50	
Ambient Temperature	-10~+55°C (not freezing condition)	
Ambient Humidity	35~85% RH	
Material	PC	
Weight	96 g	

Function selection

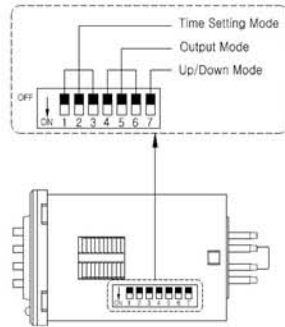

Wiring diagram

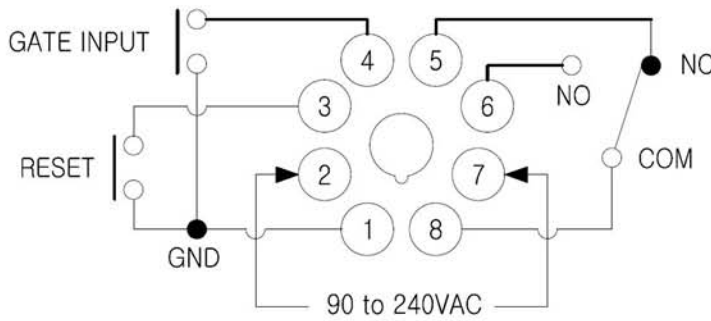



Time range selection

Position	UP mode	Position	DOWN mode
1 2 3 OFF <input checked="" type="checkbox"/> <input checked="" type="checkbox"/> <input checked="" type="checkbox"/> ON <input type="checkbox"/> <input type="checkbox"/> <input type="checkbox"/>	999.9 sec	1 2 3 OFF <input type="checkbox"/> <input checked="" type="checkbox"/> <input checked="" type="checkbox"/> ON <input checked="" type="checkbox"/> <input type="checkbox"/> <input type="checkbox"/>	9,999 sec
1 2 3 OFF <input checked="" type="checkbox"/> <input type="checkbox"/> <input checked="" type="checkbox"/> ON <input type="checkbox"/> <input checked="" type="checkbox"/> <input type="checkbox"/>	999.9 min	1 2 3 OFF <input type="checkbox"/> <input type="checkbox"/> <input checked="" type="checkbox"/> ON <input checked="" type="checkbox"/> <input checked="" type="checkbox"/> <input type="checkbox"/>	9,999 min
1 2 3 OFF <input checked="" type="checkbox"/> <input checked="" type="checkbox"/> <input type="checkbox"/> ON <input type="checkbox"/> <input type="checkbox"/> <input checked="" type="checkbox"/>	999.9 hours	1 2 3 OFF <input type="checkbox"/> <input checked="" type="checkbox"/> <input type="checkbox"/> ON <input checked="" type="checkbox"/> <input type="checkbox"/> <input checked="" type="checkbox"/>	9,999 hours
1 2 3 OFF <input checked="" type="checkbox"/> <input type="checkbox"/> <input type="checkbox"/> ON <input type="checkbox"/> <input checked="" type="checkbox"/> <input checked="" type="checkbox"/>	99 min 59 sec	1 2 3 OFF <input type="checkbox"/> <input type="checkbox"/> <input type="checkbox"/> ON <input checked="" type="checkbox"/> <input checked="" type="checkbox"/> <input checked="" type="checkbox"/>	99 hours 59 min

Counter output selection (continued)

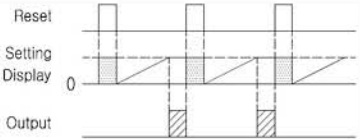
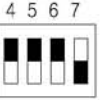
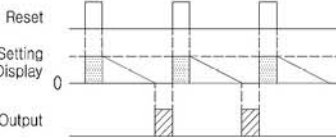
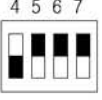
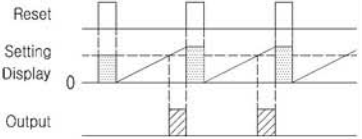
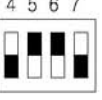
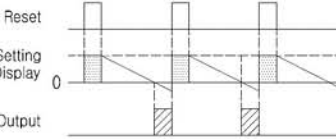
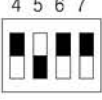
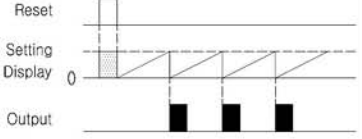
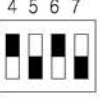
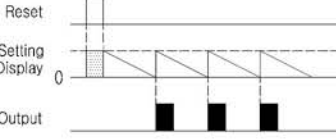
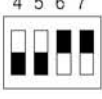
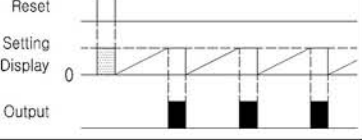
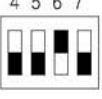
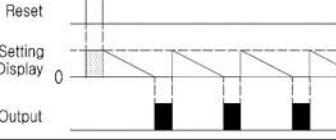
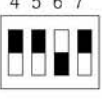
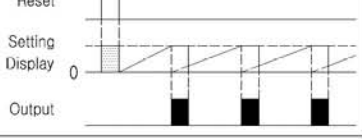
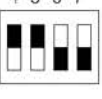
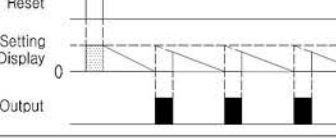
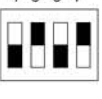
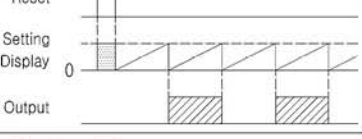
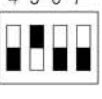
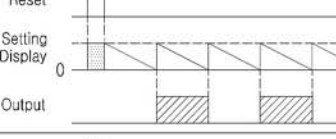
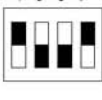
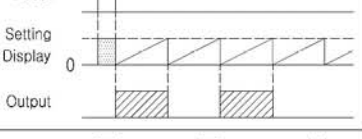
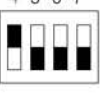
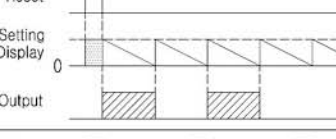
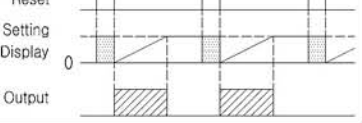
 : One shot output(0.05~5sec Setting)
  : Hold (Hold output)
  : Non-Display

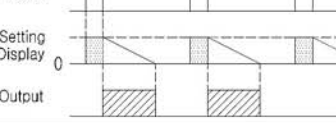
Position	UP mode	Position	DOWN mode
OFF ON 		OFF ON 	
OFF ON 		OFF ON 	
OFF ON 		OFF ON 	
OFF ON 		OFF ON 	
OFF ON 		OFF ON 	
OFF ON 		OFF ON 	
OFF ON 		OFF ON 	
OFF ON 		OFF ON 	

CONTROL COMPONENTS

SQUARE LIGHT

TOWER LIGHT

MICRO SWITCH

FOOT SWITCH

LIMIT SWITCH

POWER SWITCH

HOIST SWITCH

CAM SWITCH

BUZZER

PHOTO SENSOR

PROXIMITY SENSOR

FLOATLESS LEVEL SWITCH

TIMER & COUNTER

RELAY

SOCKETS

TERMINAL BLOCK

CONTROL BOX

PID TEMP. CONTROLLER

Dimensions

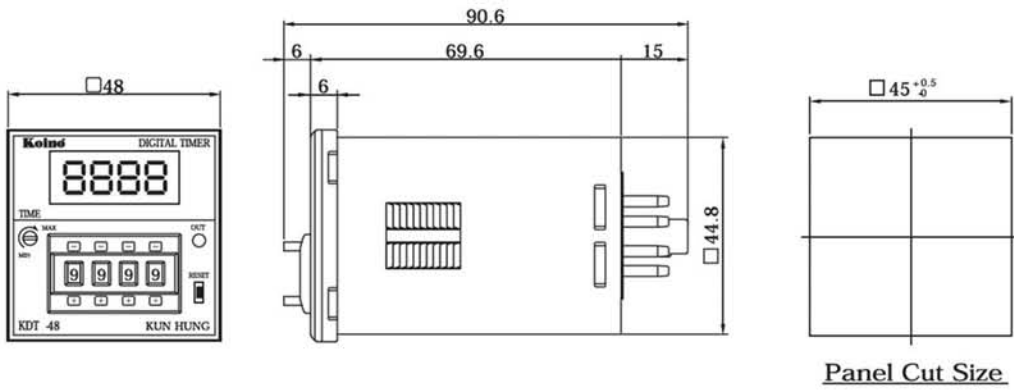

Panel Cut Size

KTM-AM MULTI-TIMER



CONTROL COMPONENTS

SQUARE LIGHT

TOWER LIGHT

MICRO SWITCH

FOOT SWITCH

LIMIT SWITCH

POWER SWITCH

HOIST SWITCH

CAM SWITCH

BUZZER

PHOTO SENSOR

PROXIMITY SENSOR

FLOATLESS LEVEL SWITCH

TIMER & COUNTER

RELAY

SOCKETS

TERMINAL BLOCK

CONTROL BOX

PID TEMP. CONTROLLER

Specification

Model	KTM-AM8	KTM-AM11	
Time Range	0.05sec~300 hours		
Voltage	24~240VAC(50/60Hz), 24~240VDC		
Power Consumption	24~240VAC: relay ON(2.5VA) relay OFF(0.8VA) 24~240VDC: relay ON(1.0W) relay OFF(0.3W)		
Output	Mode1&5: time-limit 2C		
Output	Mode2,3,4,6: instantaneous 1C+time-limit 1C		
Ratings	250VAC 5A(Resistive load)		
Relay durability	Mechanical: 10,000,000 operations Electrical: 100,000 operations		
Returning time	Max. 100ms		
Input	Start	-	Minimum signal width: 50ms
	Inhibit	-	non-voltage input
	Reset	-	non-voltage input
Repetition error	± 0.3% Max.		
Setting error	± 5% ± 50ms Max.		
Voltage error	± 0.2% Max.		
Temperature error	± 2% Max.		
Insulation resistance	100MΩ(500VDC)		
Dielectric strength	2,000VAC 50/60Hz for 1 minute		
Anti-noise resistance	Square wave (pulse width 1 μs) by noise simulator ± 2KV		
Vibration	Resistance	10~55Hz at double amplitude: 0.75mm(X,Y,Z directions) for 1 hour	
	Malfunction	10~55Hz at double amplitude: 0.5mm(X,Y,Z directions) for 10 min.	
Ambient Temperature	-10~+55°C (not freezing condition)		
Ambient Humidity	35~85% RH		
Weight	100g		

Wiring diagram

KTM-AM8: Mode 1 or 5

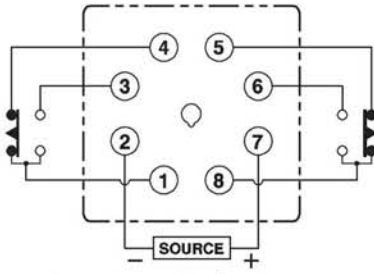

※ 24-240VAC 50/60Hz
24-240VDC

KTM-AM8: Mode 2, 3, 4, 6

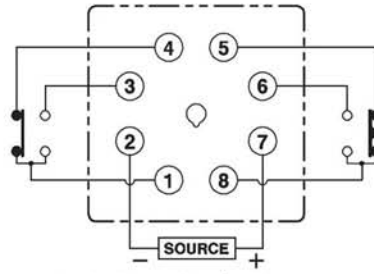

※ 24-240VAC 50/60Hz
24-240VDC

KTM-AM11

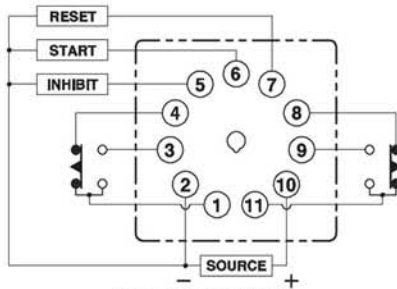

※ 24-240VAC 50/60Hz
24-240VDC

KTM-AM11E

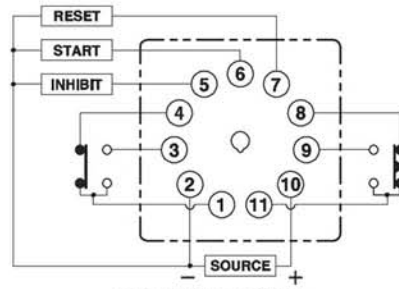

※ 24-240VAC 50/60Hz
24-240VDC

Dimensions

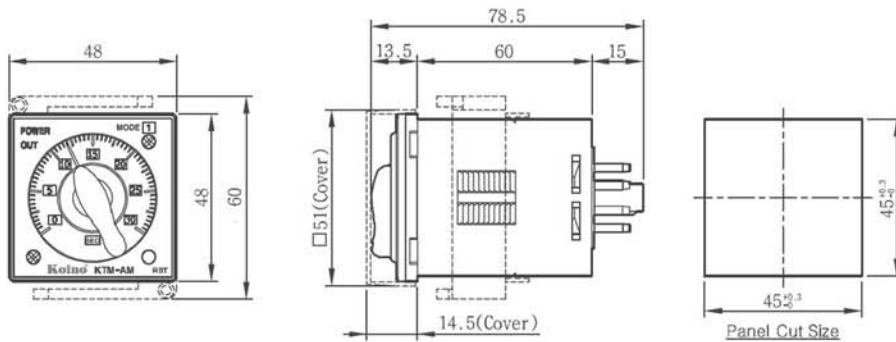

Operating Front Panel

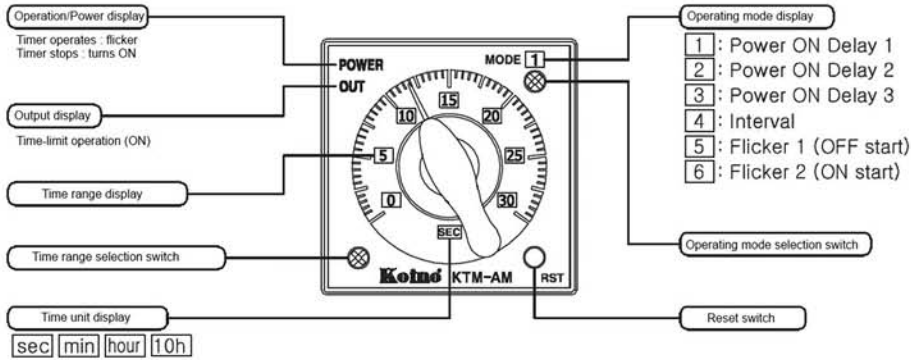

Time range

Time Unit	Time Range	Setting Time
Sec	1.2	0.05~1.2
Min	3	0.2~3
Hour	12	1~12
10 Hour	30	2~30

Mode Setting

Mode	Output	Output
	KTM-AM8	KTM-AM11
1	POWER ON DELAY 1	SIGNAL ON DELAY
2	POWER ON DELAY 2	FLICKER 1(OFF START)
3	POWER ON DELAY 3	FLICKER 2(ON START)
4	INTERVAL	INTERVAL
5	FLICKER 1(OFF START)	SIGNAL OFF DELAY
6	FLICKER 2(ON START)	SIGNAL; ON/OFF DELAY

CONTROL COMPONENTS

SQUARE LIGHT

TOWER LIGHT

MICRO SWITCH

FOOT SWITCH

LIMIT SWITCH

POWER SWITCH

HOIST SWITCH

CAM SWITCH

BUZZER

PHOTO SENSOR

PROXIMITY SENSOR

FLOATLESS LEVEL SWITCH

TIMER & COUNTER

RELAY



SOCKETS

TERMINAL BLOCK

CONTROL BOX

PID TEMP. CONTROLLER

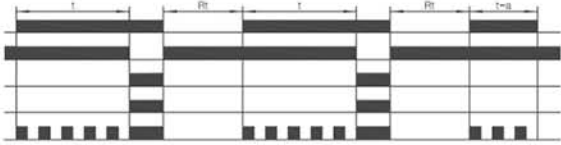
Operating mode: KTM-AM8

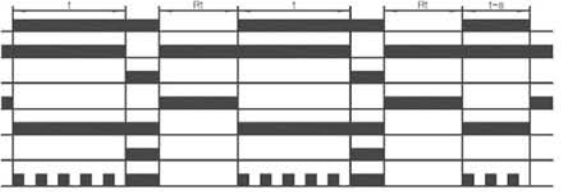
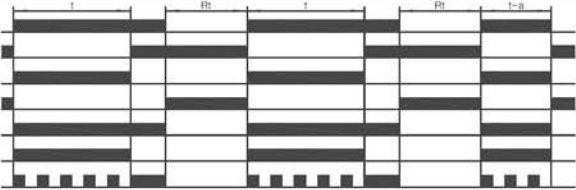
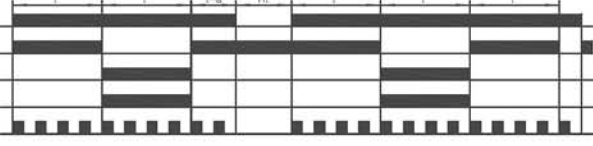
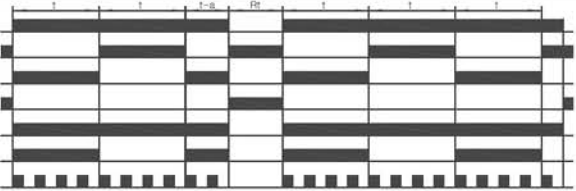
Mode	Time line
<p>1</p> <p>Power ON Delay 1</p>	<p>Power 2-7 Time limit NC 1-4, 8-5 Time limit NO 1-3, 8-6 Time limit Indicator Power indicator</p> 
<p>2</p> <p>Power ON Delay 2</p>	<p>Power 2-7 Time limit NC 8-5 Time limit NO 8-6 Instantaneous NC 1-4 Instantaneous NC 1-3 Time limit Indicator Power indicator</p> 
<p>3</p> <p>Power ON Delay 3</p>	<p>Power 2-7 Time limit NC 8-5 Time limit NO 8-6 Instantaneous NC 1-4 Instantaneous NC 1-3 Time limit Indicator Power indicator</p> 
<p>4</p> <p>Interval</p>	<p>Power 2-7 Time limit NC 8-5 Time limit NO 8-6 Instantaneous NC 1-4 Instantaneous NC 1-3 Time limit Indicator Power indicator</p> 
<p>5</p> <p>Flicker 1 (OFF start)</p>	<p>Power 2-7 Time limit NC 1-4, 8-5 Time limit NO 1-3, 8-6 Time limit Indicator Power indicator</p> 
<p>6</p> <p>Flicker 2 (ON start)</p>	<p>Power 2-7 Time limit NC 8-5 Time limit NO 8-6 Instantaneous NC 1-4 Instantaneous NC 1-3 Time limit Indicator Power indicator</p> 

Operating mode: KTM-AM11, KTM-AM11E

CONTROL COMPONENTS

SQUARE LIGHT

TOWER LIGHT

MICRO SWITCH

FOOT SWITCH

LIMIT SWITCH

POWER SWITCH

HOIST SWITCH

CAM SWITCH

BUZZER

PHOTO SENSOR

PROXIMITY SENSOR

FLOATLESS LEVEL SWITCH

TIMER & COUNTER

RELAY

SOCKETS

TERMINAL BLOCK

CONTROL BOX

PID TEMP. CONTROLLER

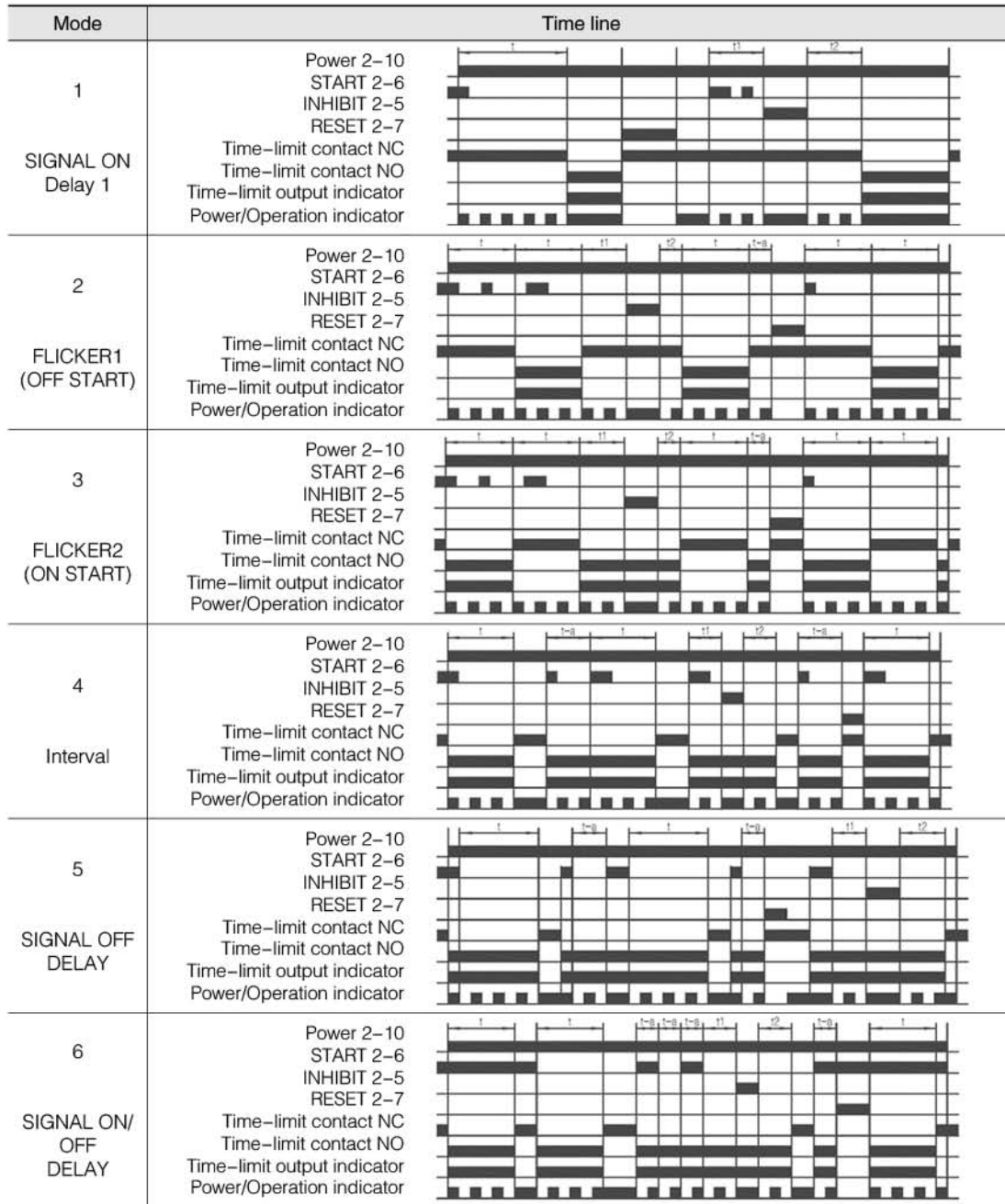

KTM-1, 2 IC TIMER

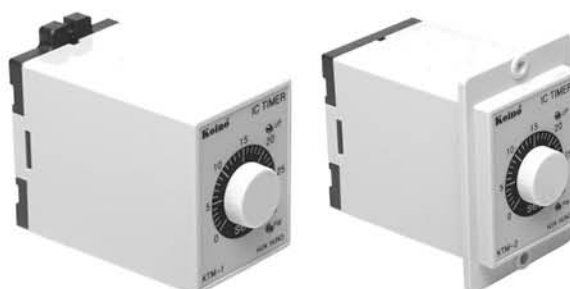

Specification

Model	KTM-1	KTM-2
Mounting	Socket	Panel Mounting
Operation	ON Delay	
Compatible sockets	KH-TDR-R8	KH-MR-8
Rated Voltage	AC type: 110/220VAC(50/60Hz)	
Rated Voltage	DC type: 12/24/48/110 VDC	
Power Consumption	AC type: 2.5 VA / DC type: 5W	
Returning time	min. 0.5 second	
Ratings	250VAC 5A(Resistive load)	
Relay durability	Mechanical: 1,000,000 operations Electrical: 200,000 operations	
Contact Output Ratings	110VAC 3A / 220VAC 1.5A / 24VDC 3A(resistive load)	
Operating time deviation	± 0.5% Max. (for maximum setting time)	
Setting error	± 5% Max. (for maximum setting time)	
Voltage error	± 0.5% Max. (for maximum setting time)	
Temperature error	± 3% Max. (for maximum setting time)	
Insulation resistance	100MΩ(500VDC)	
Dielectric strength	1,500VAC 50/60Hz for 1 minute	
Shock resistance	30G	
Vibration resistance	10~55Hz at double amplitude: 0.5mm(X,Y,Z directions) for 1 hour	
Ambient Temperature	-10~+50°C (not freezing condition)	
Ambient Humidity	35~85% RH	
Protection	IP50(indoor use only)	
Weight	210 g	

Time range

KTM-1	KTM-2	Max. Gradation	min. Gradation	Time Range
KTM-1-06S	KTM-2-06S	6 sec	0.5 sec	0.2~6 sec
KTM-1-12S	KTM-2-12S	12 sec	0.5 sec	0.2~12 sec
KTM-1-30S	KTM-2-30S	30 sec	1 sec	0.5~30 sec
KTM-1-60S	KTM-2-60S	60 sec	2.5 sec	0.5~60 sec
KTM-1-03M	KTM-2-03M	3 min	15 sec	1~180 sec
KTM-1-10M	KTM-2-10M	10 min	30 sec	10 sec~10 min
KTM-1-30M	KTM-2-30M	30 min	2.5 min	30 sec~30 min
KTM-1-60M	KTM-2-60M	60 min	2.5 min	30 sec~1hour
KTM-1-03H	KTM-2-03H	3 hours	10 min	3 min~3 hours
KTM-1-06H	KTM-2-06H	6 hours	15 min	10 min~6 hours
KTM-1-12H	KTM-2-12H	12 hours	30 min	10 min~12 hours
KTM-1-24H	KTM-2-24H	24 hours	1 hour	30 min~24 hours

Wiring diagram for self-returning type

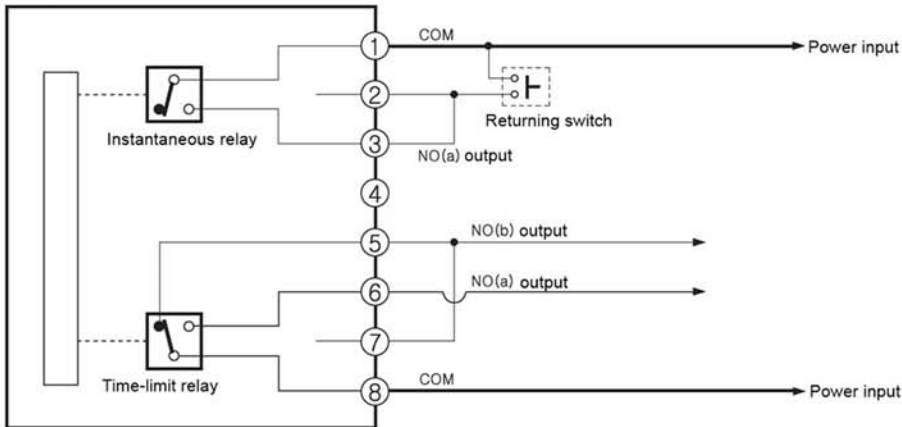

CONTROL COMPONENTS

SQUARE LIGHT

TOWER LIGHT

MICRO SWITCH

FOOT SWITCH

LIMIT SWITCH

POWER SWITCH

HOIST SWITCH

CAM SWITCH

BUZZER

PHOTO SENSOR

PROXIMITY SENSOR

FLOATLESS LEVEL SWITCH

TIMER & COUNTER

RELAY

SOCKETS

TERMINAL BLOCK

CONTROL BOX

PID TEMP. CONTROLLER

Dimensions

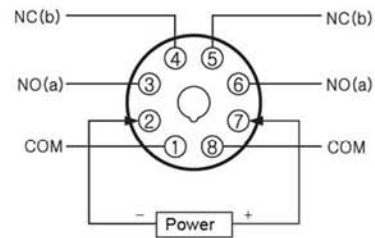
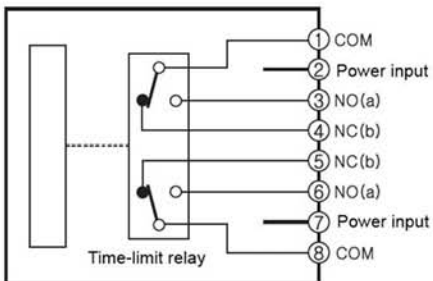
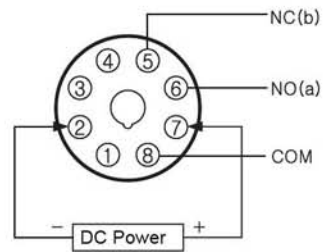
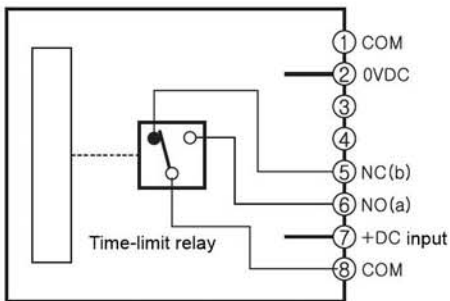
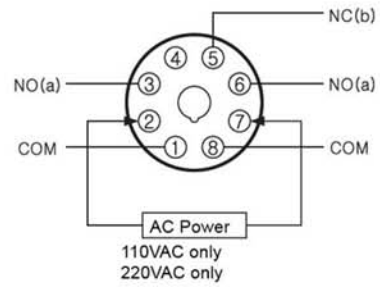
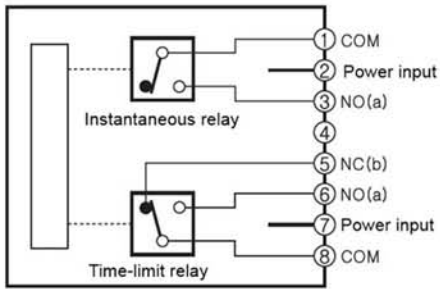

Dimensions

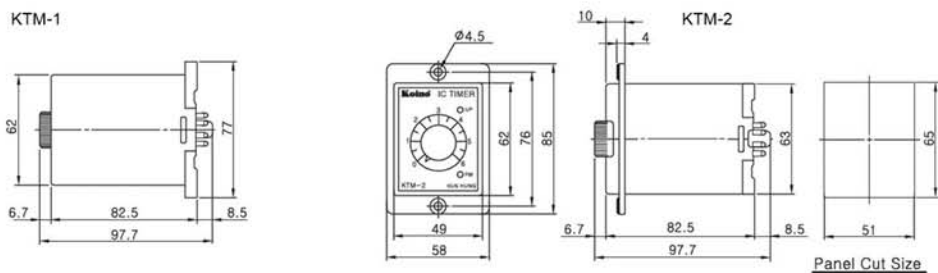

CONTROL COMPONENTS

SQUARE LIGHT

TOWER LIGHT

MICRO SWITCH

FOOT SWITCH

LIMIT SWITCH

POWER SWITCH

HOIST SWITCH

CAM SWITCH

BUZZER

PHOTO SENSOR

PROXIMITY SENSOR

FLOATLESS LEVEL SWITCH

TIMER & COUNTER

RELAY

SOCKETS

TERMINAL BLOCK

CONTROL BOX

PID TEMP. CONTROLLER

KTM-1T, 2T TWIN TIMER

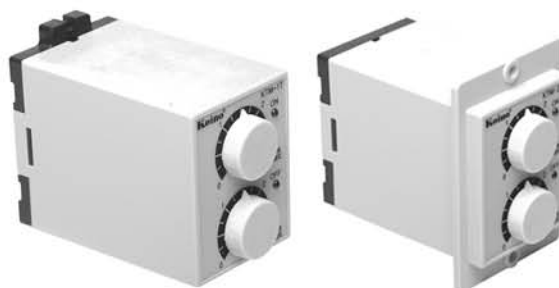

Specification

Model	KTM-1T	KTM-2T
Mounting	Socket	Panel Mounting
Operation	ON Start	
Compatible sockets	KH-TDR-R8	KH-MR-8
Rated Voltage	AC type: 110/220VAC(50/60Hz)	
Rated Voltage	DC type: 12/24/48/110 VDC	
Power Consumption	AC type: 3 VA / DC type: 5W	
Returning time	min. 0.5 second	
Ratings	250VAC 5A(Resistive load)	
Relay durability	Mechanical: 1,000,000 operations Electrical: 200,000 operations	
Contact Output Ratings	110VAC 3A / 220VAC 1.5A / 24VDC 3A(resistive load)	
Operating time deviation	± 0.5% Max. (for maximum setting time)	
Setting error	± 5% Max. (for maximum setting time)	
Voltage error	± 0.5% Max. (for maximum setting time)	
Temperature error	± 3% Max. (for maximum setting time)	
Insulation resistance	100MΩ(500VDC)	
Dielectric strength	1,500VAC 50/60Hz for 1 minute	
Shock resistance	30G	
Vibration resistance	10~55Hz at double amplitude: 0.5mm(X,Y,Z directions) for 1 hour	
Ambient Temperature	-10~+50°C (not freezing condition)	
Ambient Humidity	35~85% RH	
Protection	IP50(indoor use only)	
Weight	200~260 g	

Time range

KTM-1T	KTM-2T	Time Specification	Time Specification
		ON	OFF
KTM-1T-03S	KTM-2T-03S	3 sec	3 sec
KTM-1T-06S	KTM-2T-06S	6 sec	6 sec
KTM-1T-06S-60S	KTM-2T-06S-60S	6 sec	30 sec
KTM-1T-12S	KTM-2T-12S	12 sec	12 sec
KTM-1T-30S	KTM-2T-30S	30 sec	30 sec
KTM-1T-60S	KTM-2T-60S	60 sec	60 sec
KTM-1T-60S-06S	KTM-2T-60S-06S	60 sec	6 sec
KTM-1T-03M	KTM-2T-03M	3 min	3 min
KTM-1T-03M-30M	KTM-2T-03M-30M	3min	30 min
KTM-1T-06M	KTM-2T-06M	6 min	6 min
KTM-1T-12M	KTM-2T-12M	12 min	12 min
KTM-1T-30M	KTM-2T-30M	30 min	30 min
KTM-1T-60M	KTM-2T-60M	60 min	60 min
KTM-1T-03H	KTM-2T-03H	3 hours	3 hour
KTM-1T-06H	KTM-2T-06H	6 hours	6 hours
KTM-1T-12H	KTM-2T-12H	12 hours	12 hours
KTM-1T-24H	KTM-2T-24H	24 hours	24 hours

Wiring diagram for self-returning type

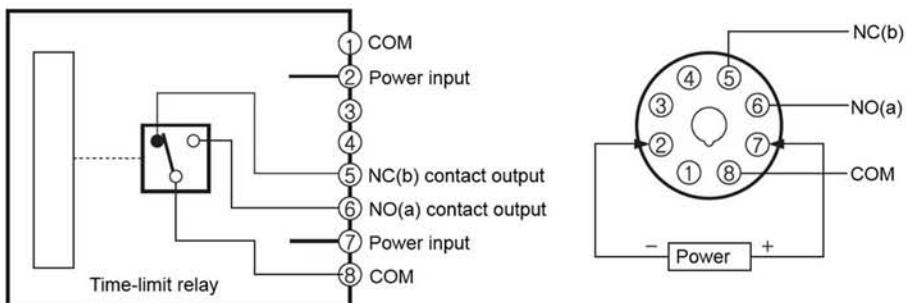

CONTROL COMPONENTS

SQUARE LIGHT

TOWER LIGHT

MICRO SWITCH

FOOT SWITCH

LIMIT SWITCH

POWER SWITCH

HOIST SWITCH

CAM SWITCH

BUZZER

PHOTO SENSOR

PROXIMITY SENSOR

FLOATLESS LEVEL SWITCH

TIMER & COUNTER

RELAY

SOCKETS

TERMINAL BLOCK

CONTROL BOX

PID TEMP. CONTROLLER

Dimensions

KTM-1T

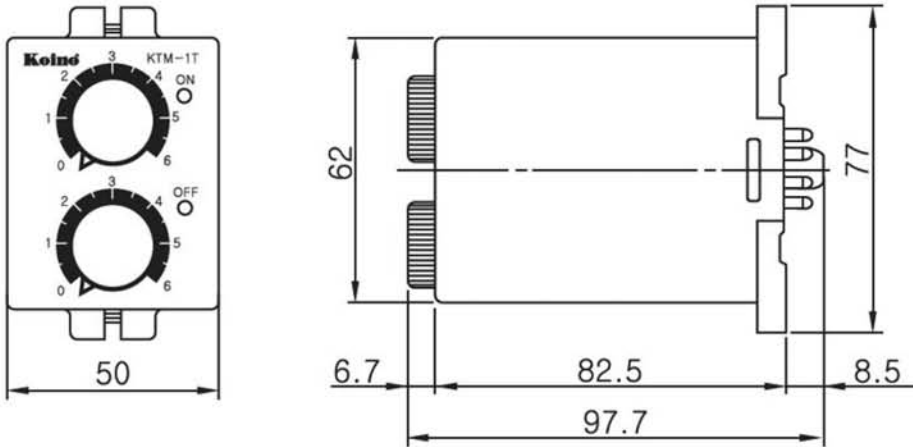

KTM-2T

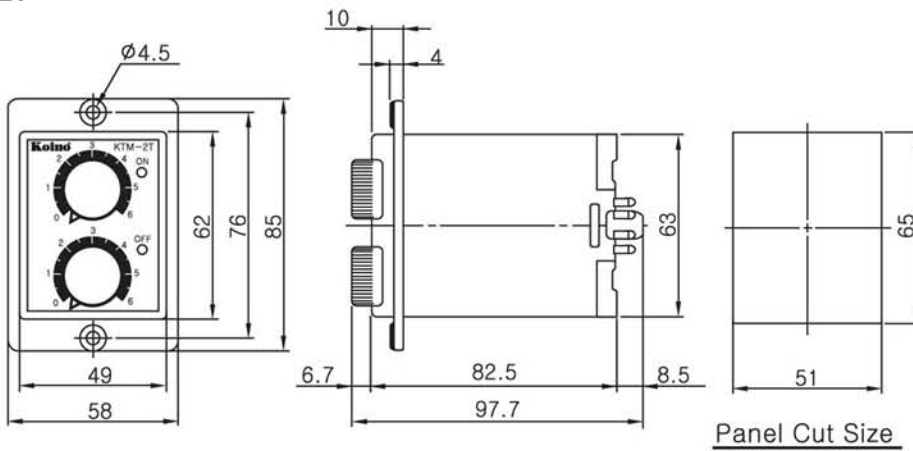

KTM-1F TIMER



DIN 48 X 48mm

CONTROL COMPONENTS

SQUARE LIGHT

TOWER LIGHT

MICRO SWITCH

FOOT SWITCH

LIMIT SWITCH

POWER SWITCH

HOIST SWITCH

CAM SWITCH

BUZZER

PHOTO SENSOR

PROXIMITY SENSOR

FLOATLESS LEVEL SWITCH

TIMER & COUNTER

RELAY

SOCKETS

TERMINAL BLOCK

CONTROL BOX

PID TEMP. CONTROLLER

Specification

Model	KTM-1F	KTM-1FN	KTM-1FR
Mounting	Socket		
Operation	ON Delay		ON Delay, Instantaneous Relay
Compatible sockets	KH-KTS-8, KH-MR-8		
Rated Voltage	24~220VAC, 24~120VDC	220 VAC ONLY	
Power Consumption	3.2VA		
Returning time	min. 0.5 second		
Relay durability	Mechanical: 1,000,000 operations Electrical: 200,000 operations		
Contact Output Ratings	110VAC 3A / 220VAC 1.5A / 24VDC 3A(resistive load)		
Operating time deviation	±0.5% Max. (for maximum setting time)		
Setting error	±5% Max. (for maximum setting time)		
Voltage error	±0.5% Max. (for maximum setting time)		
Temperature error	±3% Max. (for maximum setting time)		
Insulation resistance	100MΩ(500VDC)		
Dielectric strength	1,500VAC 50/60Hz for 1 minute		
Shock resistance	30G		
Vibration resistance	10~55Hz at double amplitude: 0.5mm(X,Y,Z directions) for 1 hour		
Ambient Temperature	-10~+50°C (not freezing condition)		
Ambient Humidity	35~85% RH		
Protection	IP50(indoor use only)		
Weight	102 g		

Dimensions

KTM-1F

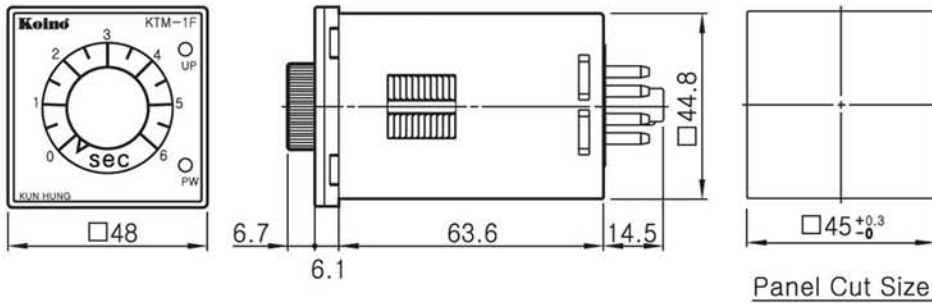

Bracket

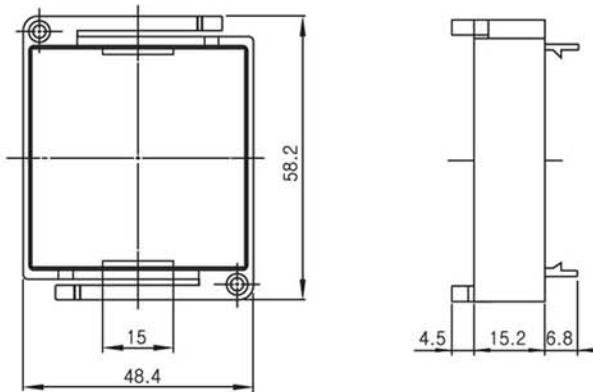

CONTROL COMPONENTS

SQUARE LIGHT

TOWER LIGHT

MICRO SWITCH

FOOT SWITCH

LIMIT SWITCH

POWER SWITCH

HOIST SWITCH

CAM SWITCH

BUZZER

PHOTO SENSOR

PROXIMITY SENSOR

FLOATLESS LEVEL SWITCH

TIMER & COUNTER

RELAY

SOCKETS

TERMINAL BLOCK

CONTROL BOX

PID TEMP. CONTROLLER

KTM-1S MULTI TIMER



DIN 36 X 40mm

Specification

Model	KTM-1S	KTM-1SN	KTM-1SR
Mounting	Socket		
Operation	ON Delay		ON Delay, Instantaneous Relay
Compatible sockets	KH-RS-R8, KH-MR-8		KH-RS-R8, KH-MR-8
Rated Voltage	90~240VAC(50/60Hz), 12, 24 VDC		220 VAC ONLY
Power Consumption	110VAC: 4.7VA, 220VAC: 16.8VA		
Returning time	min. 0.1 second		
Relay durability	Mechanical: 10,000,000 operations Electrical: 50,000 operations		
Contact Output Ratings	110VAC 3A / 220VAC 1.5A / 24VDC 3A(resistive load)		
Operating time deviation	± 0.5% Max. (for maximum setting time)		
Setting error	± 5% Max. (for maximum setting time)		
Voltage error	± 0.5% Max. (for maximum setting time)		
Temperature error	± 3% Max. (for maximum setting time)		
Insulation resistance	100MΩ(500VDC)		
Dielectric strength	1,500VAC 50/60Hz for 1 minute		
Shock	Resistance	50G	
	Malfunction	10G	
Vibration	Resistance	10~55Hz at double amplitude: 0.75mm(X,Y,Z directions) for 1 hour	
	Malfunction	10~55Hz at double amplitude: 0.5mm(X,Y,Z directions) for 1 hour	
Ambient Temperature	-10~+50°C (not freezing condition)		
Ambient Humidity	35~85% RH		
Protection	IP50(indoor use only)		
Weight	68 g		

Time range

Model No.	DIP S/W	Time specification			
		Max. setting time	min. gradation	Time range	
KTM-1S	03S		3 seconds	0.1 second	0.1~3 seconds
	30S		30 seconds	1 second	0.3~ 30 seconds
KTM-1S	06S		6 seconds	0.25 second	0.2~6 seconds
	60S		60 seconds	2.5 seconds	0.5~60 seconds
KTM-1S	12S		12 seconds	0.5 second	0.2~12 seconds
	12M		12 minutes	30 seconds	10 seconds~12 minutes
KTM-1S	03M		3 minutes	6 seconds	2 seconds~3 minutes
	30M		30 minutes	1 minute	20 seconds~30 minutes
KTM-1S	06M		6 minutes	15 seconds	6 seconds~6 minutes
	60M		60 minutes	2.5 minutes	30 seconds~60 minutes
KTM-1S	03H		3 hours	6 minutes	3 minutes~3 hours
	06H		6 hours	12 minutes	10 minutes~6 hours
KTM-1S	12H		12 hours	30 minutes	10 minutes~12 hours
	24H		24 hours	1 hour	30 minutes~24 hours

Wiring diagram

KTM-1S
KTM-1SR(220VAC)

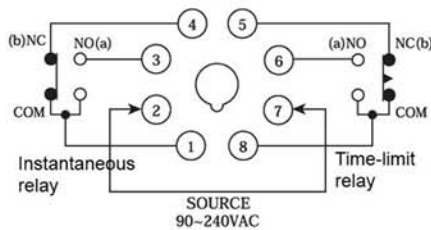

KTM-1SN

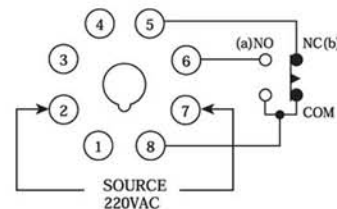

CONTROL COMPONENTS

SQUARE LIGHT

TOWER LIGHT

MICRO SWITCH

FOOT SWITCH

LIMIT SWITCH

POWER SWITCH

HOIST SWITCH

CAM SWITCH

BUZZER

PHOTO SENSOR

PROXIMITY SENSOR

FLOATLESS LEVEL SWITCH

TIMER & COUNTER

RELAY

SOCKETS

TERMINAL BLOCK

CONTROL BOX

PID TEMP. CONTROLLER

Operation mode

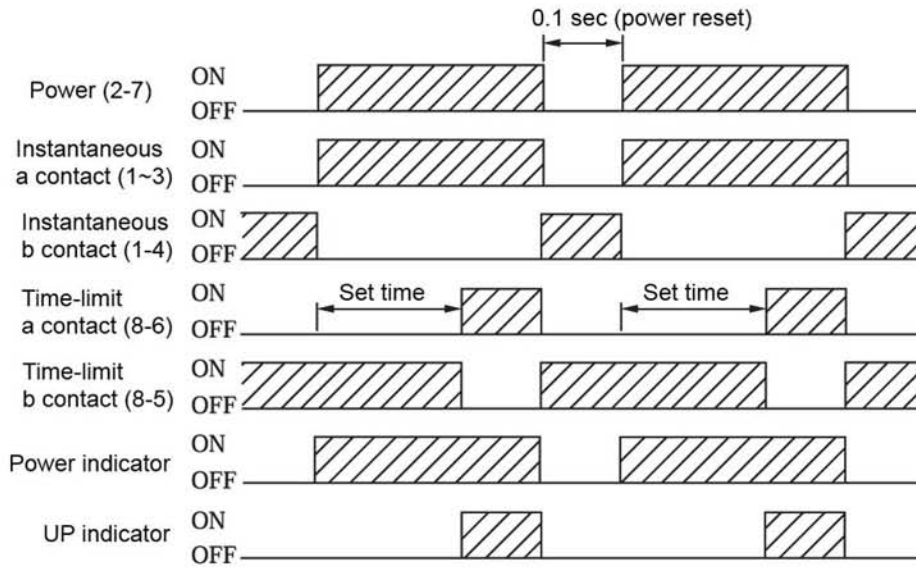

Dimensions

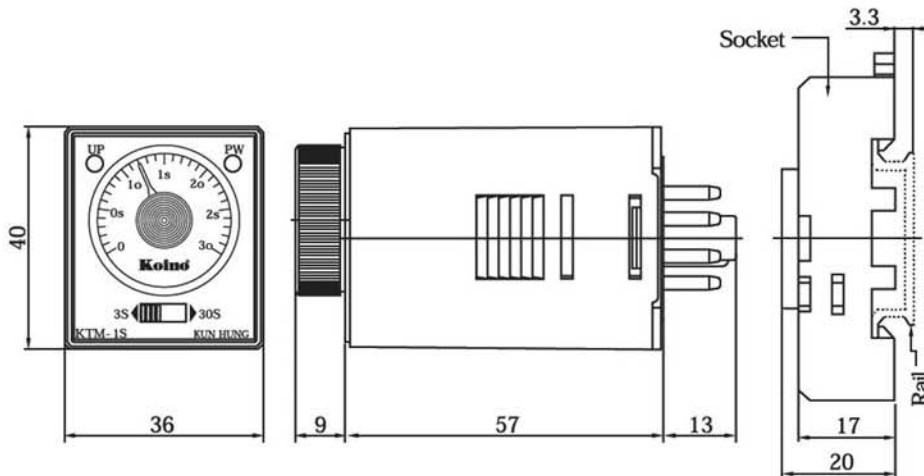

KTM-3M TIMING RELAY



CONTROL COMPONENTS

SQUARE LIGHT

TOWER LIGHT

MICRO SWITCH

FOOT SWITCH

LIMIT SWITCH

POWER SWITCH

HOIST SWITCH

CAM SWITCH

BUZZER

PHOTO SENSOR

PROXIMITY SENSOR

FLOATLESS LEVEL SWITCH

TIMER & COUNTER

RELAY

SOCKETS

TERMINAL BLOCK

CONTROL BOX

PID TEMP. CONTROLLER

Specification

Model	KTM-3M
Mounting	Socket
Operation	ON delay
Indicator	red LED
Compatible sockets	KH-RS-14M, KH-RS-14N
Rated Voltage	110/220VAC(50/60Hz) 12, 24, 48, 100VDC
Power Consumption	AC type: 2.5VA, DC type: 0.9W
Returning time	min. 0.1 second (power reset)
Relay durability	Mechanical: 3,000,000 cycles of operation Electrical: 200,000 cycles of operation (1,800 cycles/hour)
Contact Output Ratings	110VAC 3A /220VAC 1.5A / 24VDC 3A
Operating time deviation	± 0.5% Max. (for maximum setting time)
Setting error	± 5% Max. (for maximum setting time)
Voltage error	± 0.5% Max. (for maximum setting time)
Temperature error	± 2% Max. (for maximum setting time)
Insulation resistance	min. 100MΩ (500VDC)
Dielectric strength	1,500VAC 50/60Hz for 1 minute
Shock resistance	30G
Vibration resistance	10~55Hz at double amplitude: 0.5mm(X,Y,Z directions) for 1 hour
Ambient Temperature	-10~+50°C (not freezing condition)
Ambient Humidity	35~85% RH
Protection	IP50 (indoor use only)
Material	Case: ABS, Base: PBT glass, knob: PC
Weight	39g

Time range

Model No.	Max. Gradation	min. Gradation	Time Range
KTM-3M-01S	1 second	0.1 second	0.1~1 second
KTM-3M-06S	6 seconds	0.5 second	0.2~6 seconds
KTM-3M-10S	10 seconds	0.5 second	0.5~10 seconds
KTM-3M-12S	12 seconds	0.5 second	0.2~12 seconds
KTM-3M-30S	30 seconds	2.5 seconds	0.5~30 seconds
KTM-3M-60S	60 seconds	5 seconds	0.5~60 seconds
KTM-3M-03M	3 minutes	15 seconds	1~180 seconds
KTM-3M-05M	5 minutes	15 seconds	15~300 seconds
KTM-3M-10M	10 minutes	30 seconds	10 seconds~10 minutes
KTM-3M-15M	15 minutes	1 minute	30 seconds~15 minutes
KTM-3M-30M	30 minutes	2.5 minutes	30 seconds~30 minutes
KTM-3M-60M	60 minutes	5 minutes	30 seconds~1 hour
KTM-3M-03H	3 hours	10 minutes	3 minutes~3 hours
KTM-3M-06H	6 hours	30 minutes	10 minutes~6 hours
KTM-3M-12H	12 hours	1 hour	10 minutes~12 hours
KTM-3M-24H	24 hours	1 hour	30 minutes~24 hours

Wiring diagram

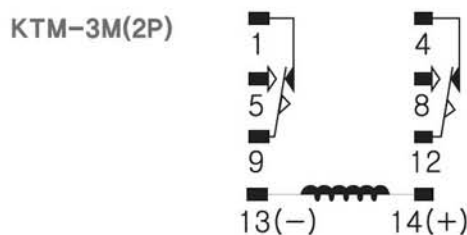
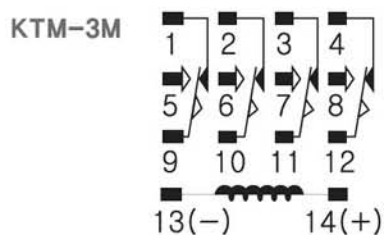

Dimensions

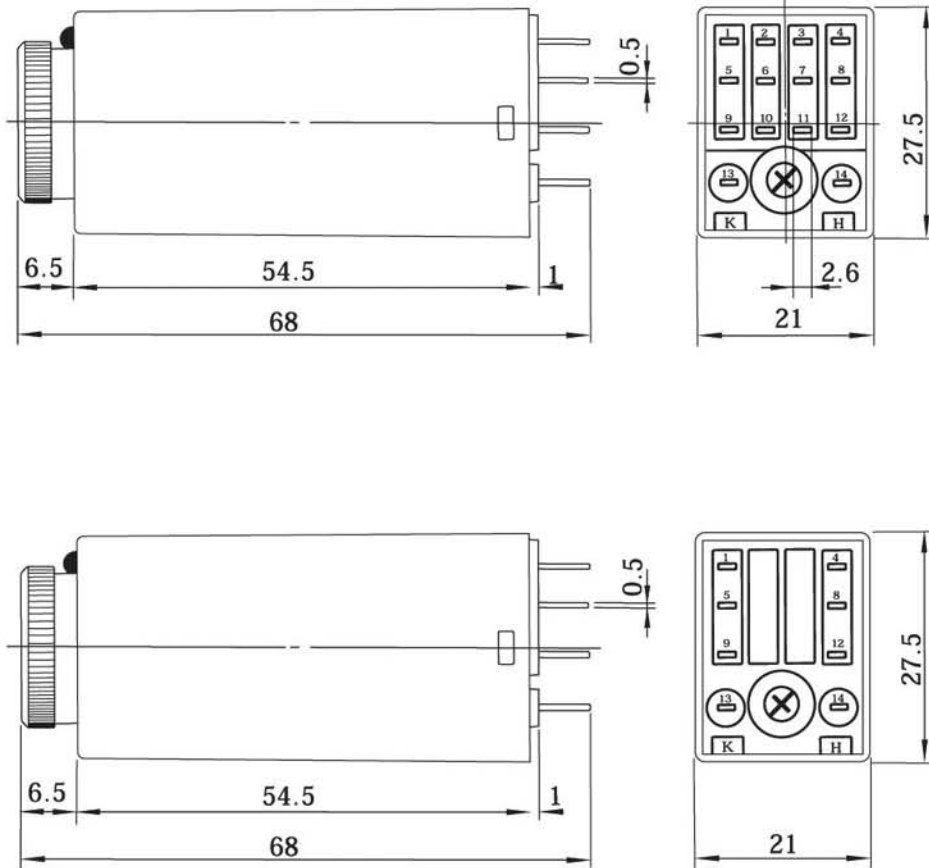

CONTROL COMPONENTS

SQUARE LIGHT

TOWER LIGHT

MICRO SWITCH

FOOT SWITCH

LIMIT SWITCH

POWER SWITCH

HOIST SWITCH

CAM SWITCH

BUZZER

PHOTO SENSOR

PROXIMITY SENSOR

FLOATLESS LEVEL SWITCH

TIMER & COUNTER

RELAY

SOCKETS

TERMINAL BLOCK

CONTROL BOX

PID TEMP. CONTROLLER

KFR1, 2 FLICKER TIMER



Specification

Model No.	KFR-1	KFR-2
Operation	ON delay	
Indicator	red LED	
Time specification	ON time: 6 seconds Max.	
Time specification	OFF time: 3 seconds Max.	
Socket	KFR-1: KH-TDR-R8	
Socket	KFR-2: KH-MR-8	
Rated voltage	AC type: 110/220VAC, DC type: 12, 24, 110VDC	
Power consumption	Actype: 2.5VA, DC type: 4W	
Contact ratings	220VAC 2.5A	
Relay durability	Mechanical: 5,000,000 cycles of operation	
Relay durability	Electrical: 200,000 cycles of operation	
Insulation resistance	min. 100M Ω (500VDC)	
Dielectric strength	2,000VAC 50/60Hz for 1 minute	
Operating time deviation	\pm 0.5% Max. (for maximum setting time)	
Ambient temperature	-10~+50°C (not freezing condition)	
Vibration resistance	10~55Hz at double amplitude: 0.5mm(X,Y,Z directions) for 1 hour	
Shock resistance	30G	
Ambient humidity	35~85% RH	
Protection	IP50 (indoor use only)	
Material	ABS	
Weight	200~210g	

Wiring diagram

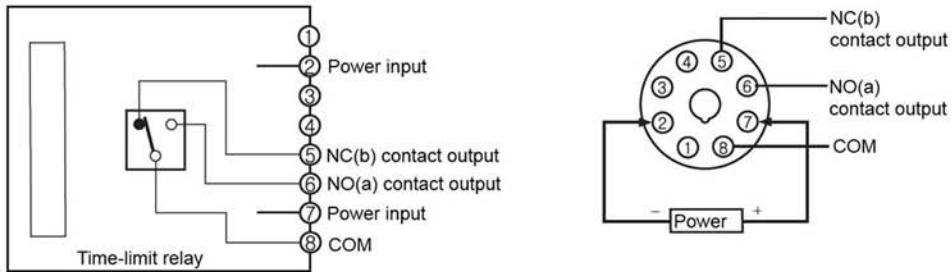

Dimensions

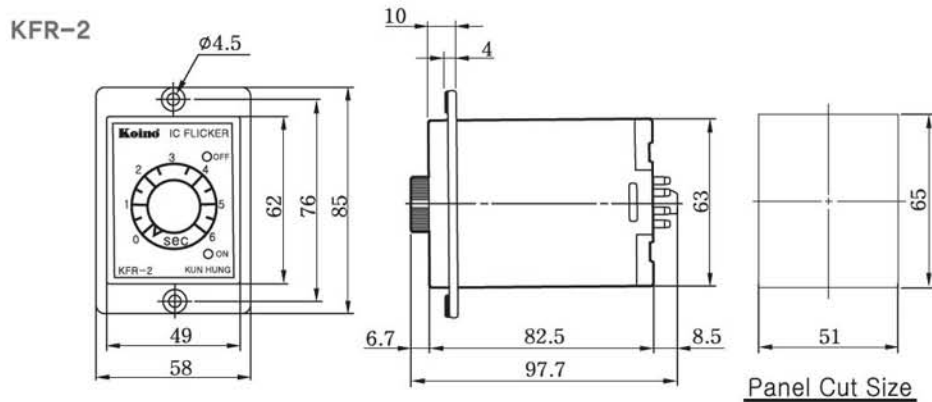
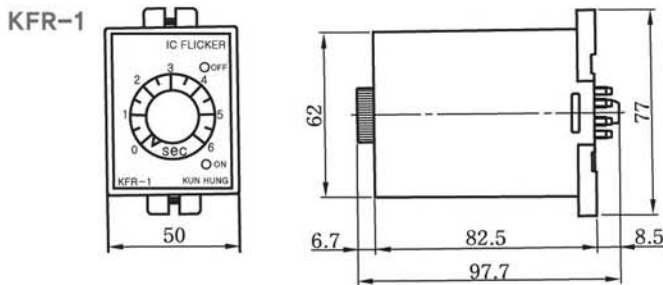

CONTROL COMPONENTS

SQUARE LIGHT

TOWER LIGHT

MICRO SWITCH

FOOT SWITCH

LIMIT SWITCH

POWER SWITCH

HOIST SWITCH

CAM SWITCH

BUZZER

PHOTO SENSOR

PROXIMITY SENSOR

FLOATLESS LEVEL SWITCH

TIMER & COUNTER

RELAY

SOCKETS

TERMINAL BLOCK

CONTROL BOX

PID TEMP. CONTROLLER

▼
Creative Passion

Koino[®]

www.koino.com