

CATALOGUE



- Automation
- Industrial applications
- Residential and Commercial



2016-2017

	Series	Page
	30 , 32 , 34 , 36 , 40 , 41 , 43 , 44 , 45 , 46 , 55 , 56 , 60 , 62 , 65 , 66 , 67 , RB , RR , 99	A
	38 , 39 , 48 , 4C , 58 19	B
	50 , 7S	C
	77	D
	70 , 71 , 72 7E 7P	E
	78	F
	7T 7F 7H	G
	80 , 81 , 83 , 84 , 85 , 86 , 88 , 93	H
	10 , 11 12 14 15	I
	18	J
	13 20 , 26 , 27	K
	22	L
	1C , 1T	M
General technical information		i



finder[®]
SWITCH TO THE FUTURE

30
SERIES

Subminiature DIL relays 2 A

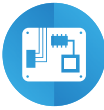

Electronic
circuit boards



Hi-Fi systems



Printers



Toys



Medical and
dentistry



Hoists and
cranes



Door and gate
openers

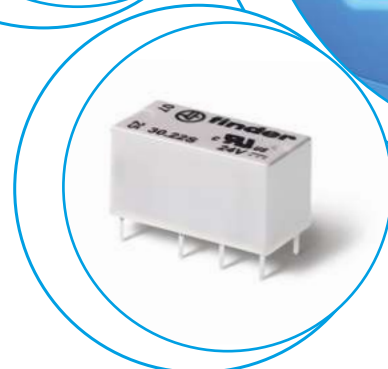
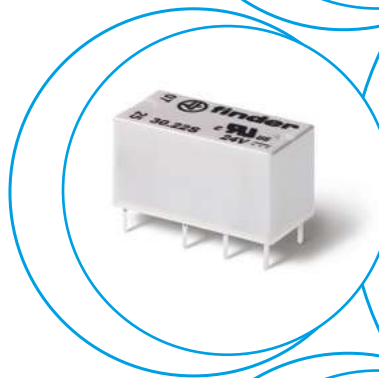

Printed circuit mount
2 A signal relay

- 2 Pole changeover contacts Low level switching capability
- Subminiature - industry standard DIL package
- Sensitive DC coil - 200 mW
- Wash tight: RT III
- Cadmium Free contact material

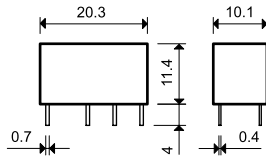

30.22



- Low coil power
- Au clad contacts
- PCB mount

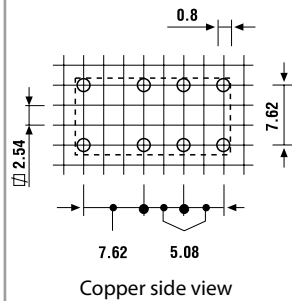
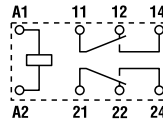

Contact specification

Contact configuration		2 CO (DPDT)
Rated current/Maximum peak current	A	2/3
Rated voltage/ Maximum switching voltage	V AC	125/250
Rated load AC1	VA	125
Rated load AC15 (230 V AC)	VA	25
Single phase motor rating (230 V AC)	kW	—
Breaking capacity DC1: 30/110/220 V	A	2/0.3/—
Minimum switching load	mW (V/mA)	10 (0.1/1)
Standard contact material		AgNi + Au

Coil specification

Nominal voltage (U _N)	V AC (50/60 Hz)	—
	V DC	5 - 6 - 9 - 12 - 24 - 48
Rated power AC/DC	VA (50 Hz)/W	—/0.2
Operating range	AC	—
	DC	See table page 5
Holding voltage	AC/DC	—/0.35 U _N
Must drop-out voltage	AC/DC	—/0.05 U _N

Technical data

Mechanical life AC/DC	cycles	—/10 · 10 ⁶
Electrical life at rated load AC1	cycles	100 · 10 ³
Operate/release time	ms	6/2
Insulation between coil and contacts (1.2/50 μs)	kV	1.5
Dielectric strength between open contacts	V AC	750
Ambient temperature range	°C	−40...+85
Environmental protection		RT III

Approvals (according to type)



Ordering information

Example: 30 series PCB relay, 2 CO (DPDT) - 2 A contacts, 12 V sensitive DC coil.

A

3 0 . 2 2 . 7 . 0 1 2 . 0 . 0 . 1 . 0

A B C D

Series ————

Type
2 = PCB mount

No. of poles
2 = 2 pole, 2 A

Coil version
7 = Sensitive DC

Coil voltage
See coil specifications

A: Contact material
0 = Standard
AgNi + Au

B: Contact circuit
0 = CO (DPDT)

D: Special versions
0 = Wash tight (RT III)

C: Options
1 = None

Technical data

Insulation according to EN 61810-1			
Nominal voltage of supply system	V AC	230/400	120...240 single phase
Rated insulation voltage	V AC	250	125
Pollution degrees		1	2
Insulation between coil and contact set			
Type of insulation		Basic	Basic
Overvoltage category		I	II
Rated impulse voltage	kV (1.2/50 µs)	1.5	1.5
Dielectric strength	V AC	1000	1000
Insulation between adjacent contacts			
Type of insulation		Basic	Basic
Overvoltage category		I	II
Rated impulse voltage	kV (1.2/50 µs)	1.5	1.5
Dielectric strength	V AC	1500	1500
Insulation between open contacts			
Type of disconnection		Micro-disconnection	Micro-disconnection
Dielectric strength	V AC/kV (1.2/50 µs)	750/1	750/1
Other data			
Bounce time: NO/NC	ms	1/3	
Vibration resistance (5...55)Hz: NO/NC	g	15/15	
Shock resistance	g	16	
Power lost to the environment	without contact current W	0.2	
	with rated current W	0.4	
Recommended distance between relays mounted on PCB	mm	≥ 5	

Contact specification

F 30 - Electrical life (AC1) v contact current (125 V)

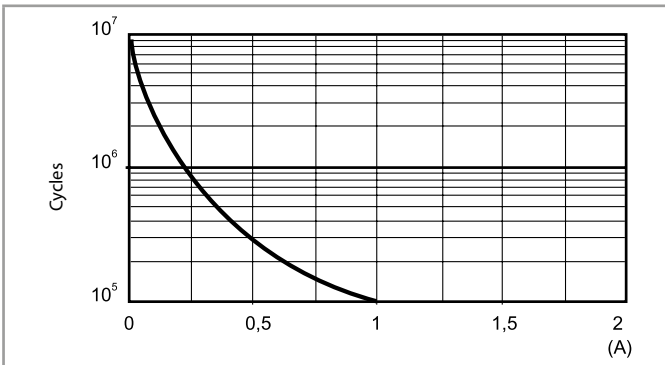

Note:
The rated current of 2 A corresponds to the limiting continuous current.

Coil specifications

DC coil data - 0.2 W sensitive

Nominal voltage U_N	Coil code	Operating range		Resistance R	Rated coil consumption I at U_N
		U_{min}	U_{max}		
V		V	V	Ω	mA
5	7.005	3.7	7.5	125	40
6	7.006	4.5	9	180	33
9	7.009	6.7	13.5	405	22
12	7.012	8.4	18	720	16
24	7.024	16.8	36	2880	8.3
48*	7.048	36	72	10000	4.8

* Rated power: 0.23 W

R 30 - DC coil operating range v ambient temperature

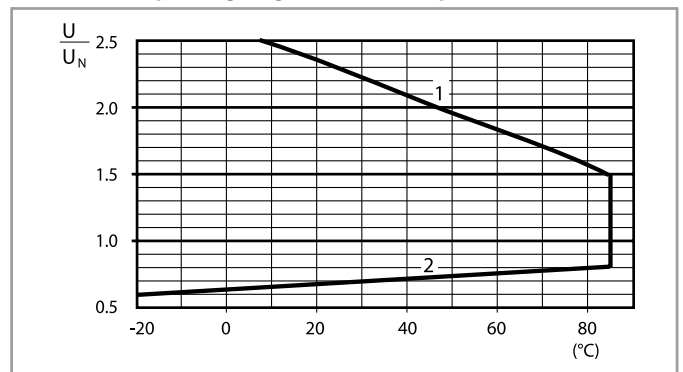

1 - Max. permitted coil voltage.
2 - Min. pick-up voltage with coil at ambient temperature.



Subminiature PCB relays 6 A



Copiers



Hi-Fi systems



Washing
machines



Control
systems



Electronic kits



Medical and
dentistry

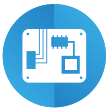

Electronic
circuit boards



Programmable
controllers

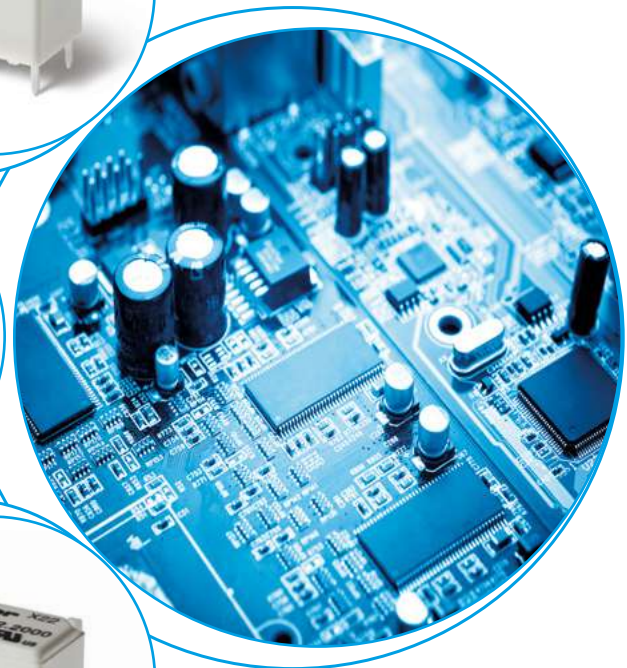
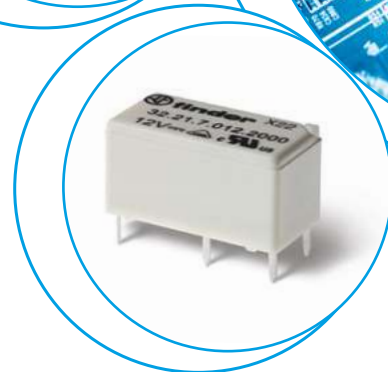
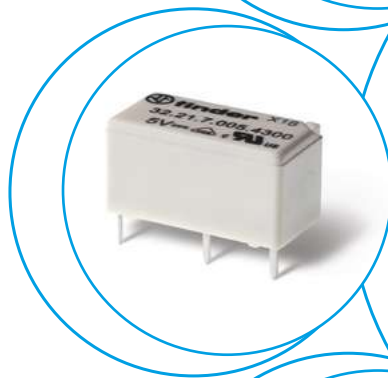

Printed circuit mount 6 A relay

- 1 Pole changeover contacts or 1 Pole normally open contact
- Subminiature, low profile package
- Sensitive DC coil - 200 mW
- Wash tight: RT III
- Cadmium Free contacts

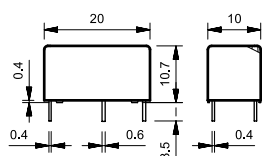

32.21-4000



- 1 CO (SPDT), 6 A
- Low coil power
- PCB mount

32.21-4300



- 1 NO (SPST-NO), 6 A
- Low coil power
- PCB mount

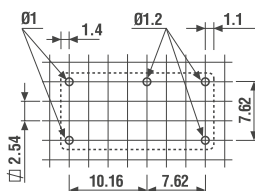
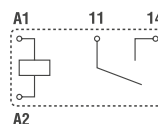
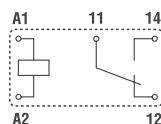

Copper side view

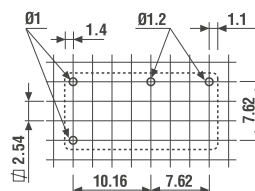

Copper side view

Contact specification

Contact configuration		1 CO (SPDT)	1 NO (SPST-NO)
Rated current/Maximum peak current	A	6/15	6/15
Rated voltage/ Maximum switching voltage	V AC	250/400	250/400
Rated load AC1	VA	1500	1500
Rated load AC15 (230 V AC)	VA	250	250
Single phase motor rating (230 V AC)	kW	0.185	0.185
Breaking capacity DC1: 30/110/220 V	A	3/0.35/0.2	3/0.35/0.2
Minimum switching load	mW (V/mA)	500 (10/5)	500 (10/5)
Standard contact material		AgSnO ₂	AgSnO ₂

Coil specification

Nominal voltage (U _N)	V AC (50/60 Hz)	—	—
	V DC	5 - 12 - 24 - 48	5 - 12 - 24 - 48
Rated power AC/DC	VA (50 Hz)/W	—/0.2	—/0.2
Operating range	AC	—	—
	DC	(0.78...1.5)U _N	(0.78...1.5)U _N
Holding voltage	AC/DC	—/0.4 U _N	—/0.4 U _N
Must drop-out voltage	AC/DC	—/0.1 U _N	—/0.1 U _N

Technical data

Mechanical life AC/DC	cycles	—/20 · 10 ⁶	—/20 · 10 ⁶
Electrical life at rated load AC1	cycles	50 · 10 ³	50 · 10 ³
Operate/release time	ms	6/4	6/2
Insulation between coil and contacts (1.2/50 μs)	kV	5	5
Dielectric strength between open contacts	V AC	1000	1000
Ambient temperature range	°C	−40...+85	−40...+85
Environmental protection		RT III	RT III

Approvals (according to type)



Ordering information

Example: 32 series PCB, 1 NO (SPDT-NO) - 6 A contacts, 24 V sensitive DC coil.

A

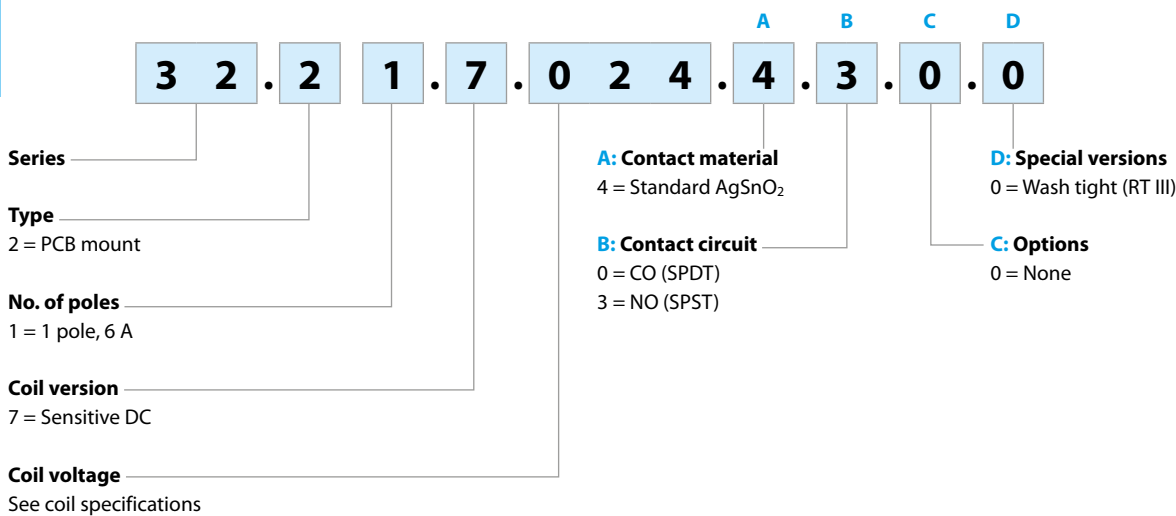

Selecting features and options: only combinations in the same row are possible.

Preferred selections for best availability are shown in **bold**.

Type	Coil version	A	B	C	D
32.21	sens. DC	4	0-3	0	0

Technical data

Insulation according to EN 61810-1			
Nominal voltage of supply system	V AC	230/400	
Rated insulation voltage	V AC	250	
Pollution degree		2	
Insulation between coil and contact set			
Type of insulation		Basic	
Overvoltage category		III	
Rated impulse voltage	kV (1.2/50 µs)	5	
Dielectric strength	V AC	4000	
Insulation between open contacts			
Type of disconnection		Micro-disconnection	
Dielectric strength	V AC/kV (1.2/50 µs)	1000/1.5	
Conducted disturbance immunity			
Burst (5...50)ns, 5 kHz, on A1 - A2 according to EN 61000-4-4		level 4 (4 kV)	
Surge (1.2/50 µs) on A1 - A2 (differential mode) according to EN 61000-4-5		level 3 (2 kV)	
Other data			
Bounce time: NO/NC	ms	2/10 (changeover) 2/— (normally open)	
Vibration resistance (5...55)Hz: NO/NC	g	10/10 (changeover) 10/— (normally open)	
Shock resistance	g	20	
Power lost to the environment	without contact current	W	0.2
	with rated current	W	0.5
Recommended distance between relays mounted on PCB	mm	≥ 5	

Contact specification

F 32 - Electrical life (AC) v contact current

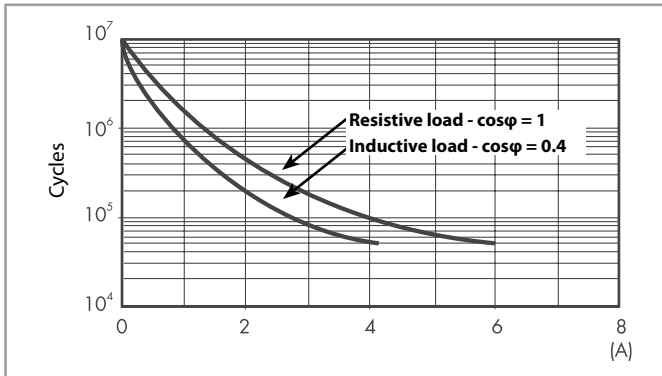

H 32 - Maximum DC1 breaking capacity

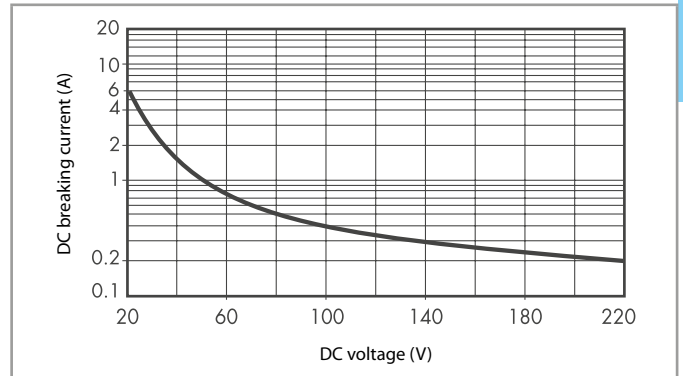

- When switching a resistive load (DC1) having voltage and current values under the curve, an electrical life of $\geq 50 \cdot 10^3$ can be expected.
 - In the case of DC13 loads, the connection of a diode in parallel with the load will permit a similar electrical life as for a DC1 load.
- Note: the release time for the load will be increased.

Coil specifications

DC coil data - 0.2 W sensitive

Nominal voltage U_N	Coil code	Operating range		Resistance R	Rated coil consumption I at U_N
		U_{min}	U_{max}		
V		V	V	Ω	mA
5	7.005	3.9	7.5	125	40
12	7.012	9.4	18	720	16
24	7.024	18.7	36	2880	8.3
48	7.048	37.4	72	11520	4

R 32 - DC coil operating range v ambient temperature

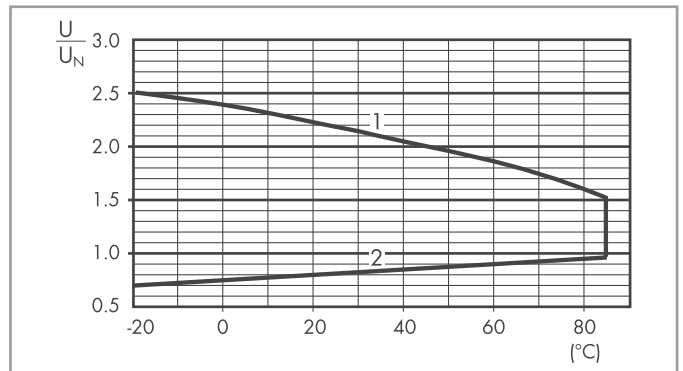

- 1 - Max. permitted coil voltage.
- 2 - Min. pick-up voltage with coil at ambient temperature.



finder[®]
SWITCH TO THE FUTURE

34
SERIES

Slim P.C.B. Relays (EMR or SSR) 0.1 - 0.2 - 2 - 6 A



Bottling plant



Packaging machines



Labelling machines



Road / tunnel lighting



Burners, boilers and furnaces



Timers and lighting controls

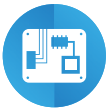

Electronic circuit boards



Programmable controllers

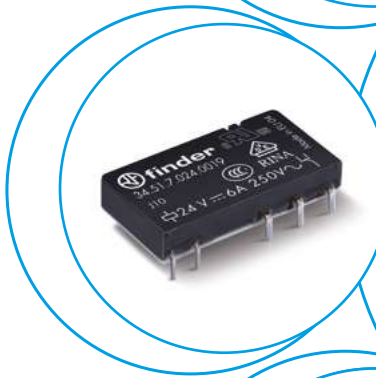

Ultra-slim 1 Pole - 6 A relay

Printed circuit mount

- direct or via PCB socket

35 mm rail mount

- via screw, screwless or push-in terminal sockets

- 1 Pole changeover contacts or 1 Pole normally open contact
- Ultra slim (5 mm), package
- Sensitive DC coil - 170 mW (Dual AC/DC coil drive possible using 93 series sockets)
- UL Listing (certain relay/socket combinations)
- Cadmium Free contact materials
- 8/8 mm clearance/creepage distance
- 6 kV (1.2/50 μ s) insulation, coil-contacts

FOR UL RATINGS SEE:

"General technical information" page V

For outline drawing see page 9

Contact specification

Contact configuration		1 CO (SPDT)	1 CO (SPDT)
Rated current/ Maximum peak current	A	6/10	6/10
Rated voltage/ Maximum switching voltage	V AC	250/400	250/400
Rated load AC1	VA	1500	1500
Rated load AC15 (230 V AC)	VA	300	300
Single phase motor rating (230 V AC)	kW	0.185	0.185
Breaking capacity DC1: 30/110/220 V	A	6/0.2/0.12	6/0.2/0.12
Minimum switching load	mW (V/mA)	500 (12/10)	50 (5/2)
Standard contact material		AgNi	AgNi + Au

Coil specification

Nominal voltage (U_N)	V AC (50/60 Hz)	—	—
	V DC	5 - 12 - 24 - 48 - 60	5 - 12 - 24 - 48 - 60
Rated power AC/DC	VA (50 Hz)/W	—/0.17	—/0.17
Operating range	AC	—	—
	DC	(0.7...1.5) U_N	(0.7...1.5) U_N
Holding voltage	AC/DC	—/0.4 U_N	—/0.4 U_N
Must drop-out voltage	AC/DC	—/0.05 U_N	—/0.05 U_N

Technical data

Mechanical life AC/DC	cycles	—/10 · 10 ⁶	—/10 · 10 ⁶
Electrical life at rated load AC1	cycles	60 · 10 ³	60 · 10 ³
Operate/release time	ms	5/3	5/3
Insulation between coil and contacts (1.2/50 μ s)	kV	6 (8 mm)	6 (8 mm)
Dielectric strength between open contacts	V AC	1000	1000
Ambient temperature range	°C	-40...+85	-40...+85
Environmental protection		RT II	RT II

Approvals (according to type)

NEW 34.51



- 5 mm wide
- Low coil power
- PCB or 93 series sockets

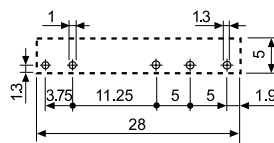
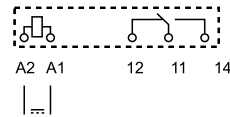

Copper side view

NEW 34.51-5010



- 5 mm wide
- Low coil power
- PCB or 93 series sockets
- Contact AgNi + Au

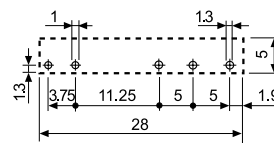
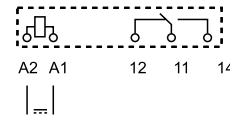

Copper side view

Ultra-slim Solid State Relays

Printed circuit mount

- direct or via PCB socket

35 mm rail mount

- via screw, screwless or push-in terminal sockets

- Single circuit output switching options
 - 6 A, 24 V DC
 - 2 A, 240 V AC
- Silent, high speed switching with long electrical life
- Ultra slim (5 mm), package
- Sensitive DC Input circuits (Dual AC/DC input drive possible using 93 series sockets)
- UL Listing (certain relay/socket combinations)
- Wash tight: RT III
- 3000 V AC insulation, input-output

NEW 34.81.7.xxx.9024



- 6 A, 24 V DC output switching
- PCB or 93 series sockets

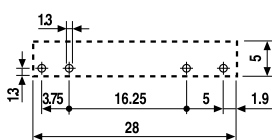
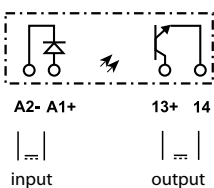

Copper side view

NEW 34.81.7.xxx.8240



- 2 A, 240 V AC output switching
- Zero crossing switching
- PCB or 93 series sockets

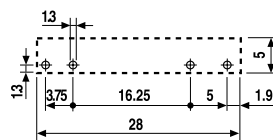
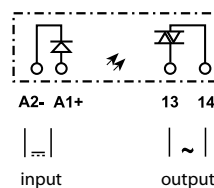

Copper side view

For outline drawing see page 9

Output circuit									
Contact configuration		1 NO (SPST-NO)				1 NO (SPST-NO)			
Rated current/ Maximum peak current (10 ms)	A	6/50				2/80			
Rated switching voltage	V	24 DC				240 AC (50/60 Hz)			
Switching voltage range	V	(1.5...33)DC				(12...275)AC			
Maximum blocking voltage	V	33				—			
Repetitive peak off-state voltage	V _{pk}	—				800			
Rated load DC13	W	36				—			
Rated load AC15	VA	—				300			
Minimum switching current	mA	1				35			
Max. "OFF-state" leakage current	mA	0.001				1.5			
Max. "ON-state" voltage drop	V	0.4				1.6			
Supply specification									
Nominal voltage (U _N)	V DC	5	12	24	60	5	12	24	60
Rated power	W	0.035	0.085	0.17	0.21	0.06	0.085	0.17	0.21
Operating range	V DC	35...12	8...17	16...30	35...72	35...10	8...17	16...30	35...72
Control current	mA	7	7	7	3.5	12	7	7	3.5
Release voltage	V DC	4	4	10	20	1	4	10	20
Technical data									
Electrical life at rated load	cycles	> 10 ⁶				> 10 ⁶			
Operate/release time	ms	0.02/0.2				11/11			
Insulation between input and output (1.2/50μs)	kV	4				4			
Ambient temperature range	°C	-20...+70*				-20...+50*			
Environmental protection		RT III				RT III			
Approvals (according to type)									

* Note: all technical data relates to using the relay directly on PCB or PCB socket type 93.11.

If the relay is used with 35 mm rail socket type 93.51, refer to the technical data of 38 Series; if used with types 93.60, 93.61, 93.62, 93.63, 93.64, 93.65, 93.66, 93.67, 93.68 and 93.69, refer to the technical data of the MasterINTERFACE 39 Series. See L34 diagrams page 8

Ultra-slim Solid State Relays

Printed circuit mount

- direct or via PCB socket

35 mm rail mount

- via screw, screwless or push-in terminal sockets

- Single circuit output switching options
 - 0.1 A, 48 V DC
 - 0.2 A, 220 V DC
- Silent, high speed switching with long electrical life
- Ultra slim (5 mm), package
- Sensitive DC Input circuits (Dual AC/DC input drive possible using 93 series sockets)
- UL Listing (certain relay/socket combinations)
- Wash tight: RT III
- 3000 V AC insulation, input-output

NEW 34.81.7.xxx.7048

NEW 34.81.7.xxx.7220



- 100 mA, 48 V DC output switching
- PCB or 93 series sockets

- 200 mA, 110/220 V DC output switching
- PCB or 93 series sockets

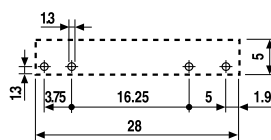
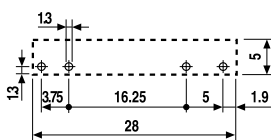
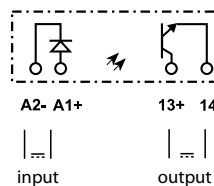
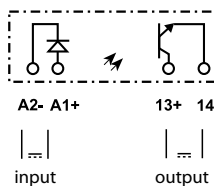

For outline drawing see page 9

Copper side view

Copper side view

Output circuit

Contact configuration		1 NO (SPST-NO)		1 NO (SPST-NO)	
Rated current/ Maximum peak current (10 ms)	A	0.1/0.5		0.2/10	
Rated switching voltage	V	48 DC		220 DC	
Switching voltage range	V	(1.5...53)DC		(90...256)DC	
Maximum blocking voltage	V	53		256	
Rated load DC13	W	2.4		44	
Minimum switching current	mA	0.05		0.05	
Max. "OFF-state" leakage current	mA	0.001		0.001	
Max. "ON-state" voltage drop	V	1		0.4	

Supply specification

Nominal voltage (U _N)	V DC	24	60	24	60
Rated power	W	0.17	0.21	0.17	0.21
Operating range	V DC	16...30	35...72	16...30	35...72
Control current	mA	7	3.5	7	3.5
Release voltage	V DC	10	20	10	20

Technical data

Electrical life at rated load	cycles	> 10 ⁶		> 10 ⁶	
Operate/release time	ms	0.03/0.6		0.4/2.2	
Insulation between input and output (1.2/50μs)	kV	4		4	
Ambient temperature range	°C	-20...+70*		-20...+70*	
Environmental protection		RT III		RT III	

Approvals (according to type)

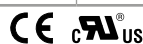

* Note: all technical data relates to using the relay directly on PCB or PCB socket type 93.11. If the relay is used with 35 mm rail socket type 93.51, refer to the technical data of 38 Series; if used with types 93.60, 93.61, 93.62, 93.63, 93.64, 93.65, 93.66, 93.67, 93.68 and 93.69, refer to the technical data of the Master **INTERFACE** 39 Series.

Ordering information

Electromechanical relay (EMR)

A

Example: 34 series slim electromechanical relay, 1 CO (SPDT) 6 A contacts, 24 V sensitive DC coil.

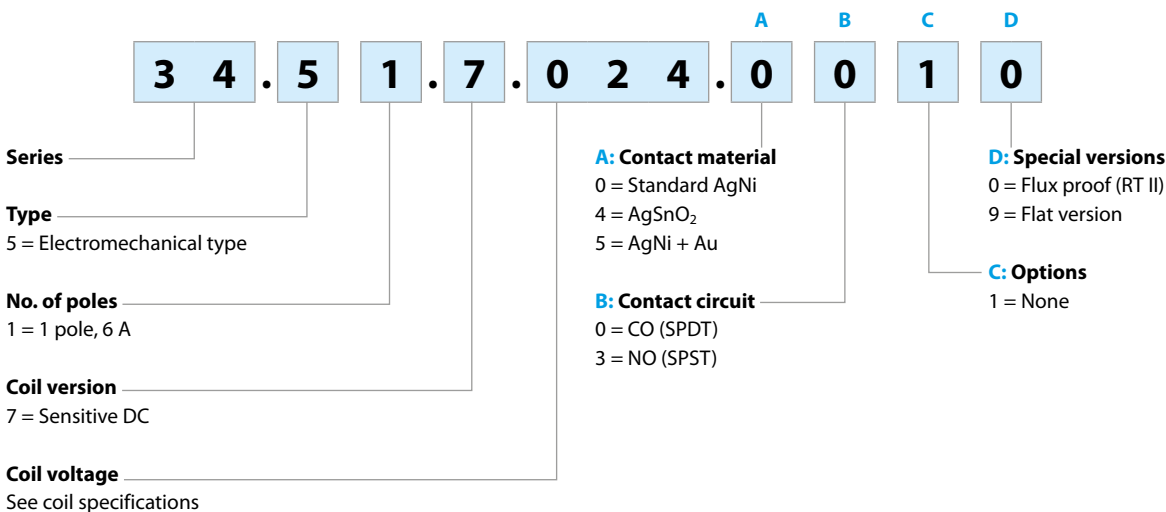

Selecting features and options: only combinations in the same row are possible.

Preferred selections for best availability are shown in **bold**.

Type	Coil version	A	B	C	D
34.51	sens. DC	0 - 4 - 5	0 - 3	1	0
34.51	sens. DC	0 - 4 - 5	0	1	9

Solid state relay (SSR)

Example: 34 series solid state relay, 6 A 24 V DC output, 24 V DC supply.

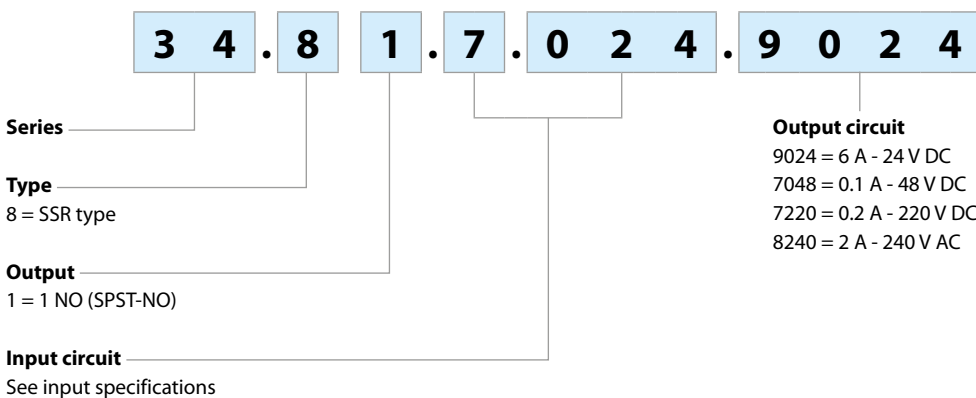

Flat pack version

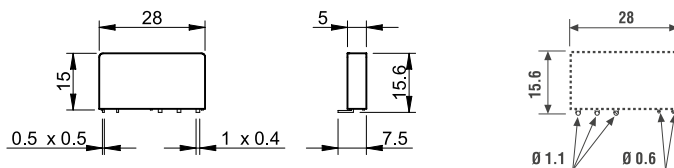

Copper side view

Option = 34.51.7xxx.x019

Environmental protection RT I

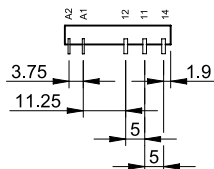

Electromechanical relay

A

Technical data

Insulation according to EN 61810-1

Nominal voltage of supply system	V AC	230/400	
Rated insulation voltage	V AC	250	400
Pollution degree		3	2

Insulation between coil and contact set

Type of insulation		Reinforced
Overvoltage category		III
Rated impulse voltage	kV (1.2/50 μ s)	6
Dielectric strength	V AC	4000

Insulation between open contacts

Type of disconnection		Micro-disconnection
Dielectric strength	V AC/kV (1.2/50 μ s)	1000/1.5

Conducted disturbance immunity

Burst (5...50)ns, 5 kHz, on A1 - A2 according to EN 61000-4-4		level 4 (4 kV)
Surge (1.2/50 μ s) on A1 - A2 (differential mode) according to EN 61000-4-5		level 3 (2 kV)

Other data

Bounce time: NO/NC	ms	1/6	
Vibration resistance (5...55)Hz: NO/NC	g	10/5	
Shock resistance	g	20/14	
Power lost to the environment	without contact current	W	0.2
	with rated current	W	0.5
Recommended distance between relays mounted on PCB	mm	≥ 5	

Contact specification

F 34 - Electrical life (AC) v contact current

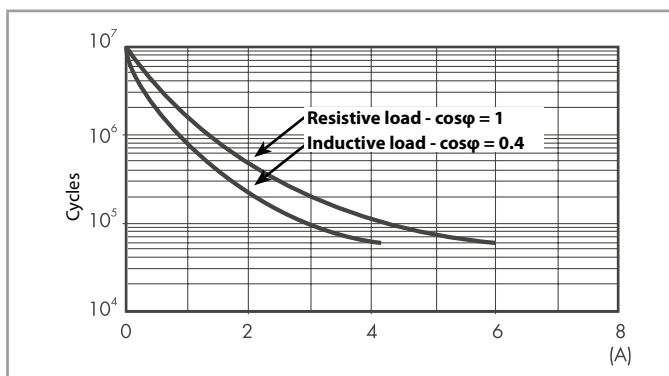

H 34 - Maximum DC1 breaking capacity

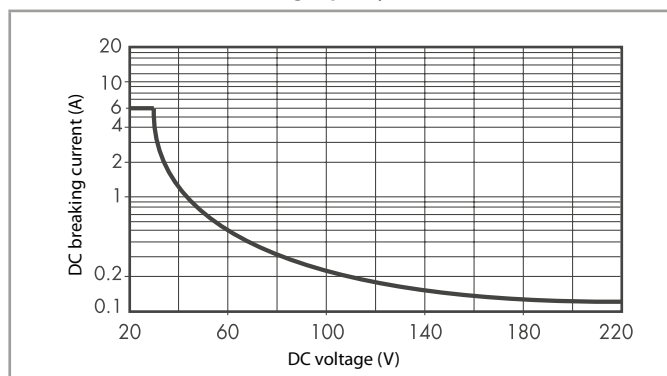

- When switching a resistive load (DC1) having voltage and current values under the curve, an electrical life of $\geq 60 \cdot 10^3$ can be expected.
 - In the case of DC13 loads, the connection of a diode in parallel with the load will permit a similar electrical life as for a DC1 load.
- Note: the release time for the load will be increased.

Coil specifications

DC coil data

Nominal voltage U_N	Coil code	Operating range		Resistance R	Rated coil consumption I at U_N
		U_{min}	U_{max}		
V		V	V	Ω	mA
5	7.005	3.5	7.5	130	38.4
12	7.012	8.4	18	840	14.2
24	7.024	16.8	36	3350	7.1
48	7.048	33.6	72	12300	3.9
60	7.060	42	90	19700	3

R 34 - DC coil operating range v ambient temperature

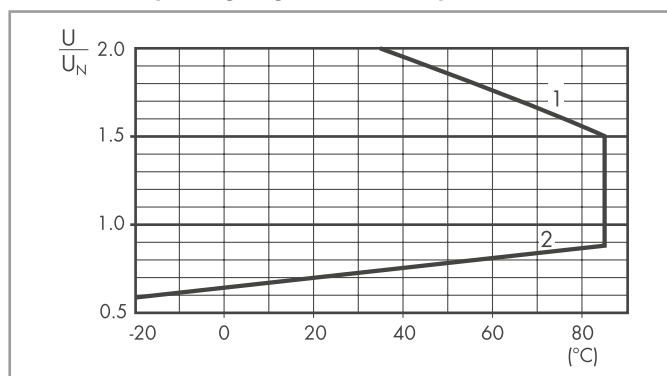

- 1 - Max. permitted coil voltage.
- 2 - Min. pick-up voltage with coil at ambient temperature.

Solid state relay

Technical data

A

Insulation		Dielectric strength	Impulse (1.2/50 μ s)
Between input and output		3000 V AC	4 kV
EMC specifications		Reference standard	
Electrostatic discharge	contact discharge	EN 61000-4-2	4 kV
	air discharge	EN 61000-4-2	8 kV
Radiated electromagnetic field (80...1000 MHz)		EN 61000-4-3	10 V/m
Fast transients on supply terminals (burst 5/50 ns, 5 and 100 kHz)		EN 61000-4-4	2 kV
Voltage pulses on supply terminals (surge 1.2/50 μ s)	common mode	EN 61000-4-5	0.7 kV
	differential mode	EN 61000-4-5	0.7 kV*
Radio-frequency common mode voltage (0.15...230 MHz)		EN 61000-4-6	10 V
Other data			
Power lost to the environment	without output current	W	0.15
	with rated current	W	0.4

* For 34.81.7.005... = 0.3 kV; for 34.81.7.012... = 0.5 kV

Input specification

Input data - DC types

Nominal voltage U_N V	Input code	Operating range		Release voltage V	Impedance Ω	Control current I at U_N mA
		U_{min} V	U_{max} V			
5	7.005	3.5	12*	1	715	7*
12	7.012	8	17	4	1715	7
24	7.024	16	30	10	3430	7
60	7.060	35	72	20	17000	3.5

* For 34.81.7.005.8240: $U_{MAX} = 10$ V, I @ 5 V = 12 mA

Output specification

L 34-1 - Output DC current v ambient temperature

34.81.7...9024

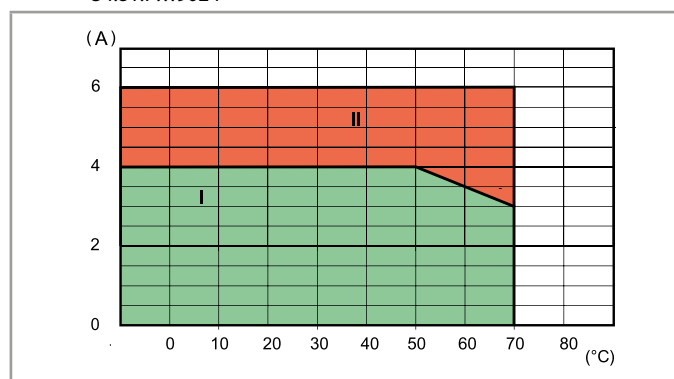

L 34 - Output AC current v ambient temperature

34.81.7...8240

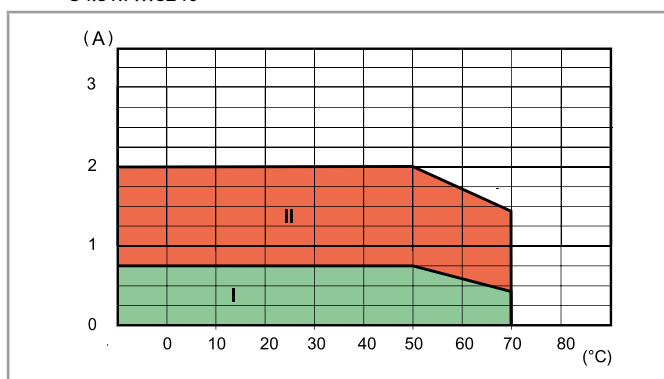

I: SSR installed on 93 series sockets as a group (without gap between sockets)

II: SSR installed individually in free air, or with a gap ≥ 9 mm, which implies a not significant influence from nearby components

Max recommended switching frequency (Cycles/Hour, with 50% Duty-cycle) at ambient temperature 50°C, single mounting

Load	34.81.7xxx.9024	34.81.7xxx.8240	34.81.7xxx.7048	34.81.7xxx.7220
24 V 6 A DC1	180 000	—	—	—
24 V 3 A DC L/R = 10 ms	5000	—	—	—
24 V 2 A DC L/R = 40 ms	3600	—	—	—
24 V 1 A DC L/R = 40 ms	6500	—	—	—
24 V 0.8 A DC L/R = 40 ms	9000	—	—	—
24 V 1.5 A DC L/R = 80 ms	3250	—	—	—
230 V 2 A AC1	—	60 000	—	—
230 V 1.25 A AC15	—	3600	—	—
48 V 0.1 A DC1	—	—	60 000	—
220 V 0.2 A DC1	—	—	—	60 000

Outline drawings

Type 34.51

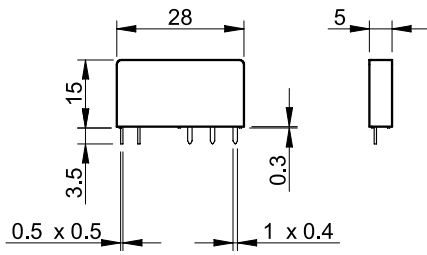

Type 34.81

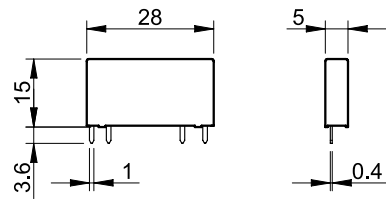

A

A

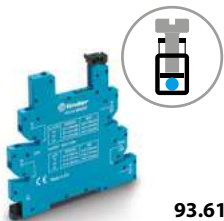

93.61

Screw terminal socket 35 mm rail mounting (EN 60715)**Common features**

- Space saving 6.2 mm wide
- Connections for 16-way jumper link
- Integral coil indication and protection circuit
- Secure retention and easy ejection by plastic clip
- Dual screw head (blade+cross) terminals

NEW

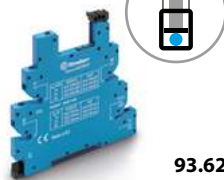
For technical data and supply versions, refer to the Master **INTERFACE 39 Series** – “Relay interface module”

93.62

Electromechanical Relay - EMR

Supply voltage	Relay type	Socket type (reference with the 39 Series)				
		Master BASIC (39.11.....)	Master PLUS (39.31.....)	Master INPUT (39.41.....)	Master OUTPUT (39.21.....)	Master TIMER (39.81.....)
6 V AC/DC	34.51.7.005.xx10	93.61.7.024	93.63.7.024	93.64.7.024	93.62.7.024	—
12 V AC/DC	34.51.7.012.xx10	93.61.7.024	93.63.7.024	93.64.7.024	93.62.7.024	93.68.0.024
24 V AC/DC	34.51.7.024.xx10	93.61.7.024	93.63.7.024	93.64.7.024	93.62.7.024	93.68.0.024
60 V AC/DC	34.51.7.060.xx10	—	93.63.7.060	—	—	—
(110...125)V AC/DC*	34.51.7.060.xx10	—	93.63.3.125	—	—	—
(220...240)V AC*	34.51.7.060.xx10	—	93.63.3.230	—	—	—
(110...125)V AC/DC	34.51.7.060.xx10	93.61.0.125	93.63.0.125	93.64.0.125	93.62.0.125	—
(24...240)V AC/DC	34.51.7.024.xx10	—	93.63.0.240	—	—	—
(220...240)V AC	34.51.7.060.xx10	93.61.8.230	93.63.8.230	93.64.8.230	93.62.8.230	—
(110...125)V DC	34.51.7.060.xx10	—	93.63.7.125	—	—	—
220 V DC	34.51.7.060.xx10	—	93.63.7.220	—	—	—

* Leakage current suppression



93.64

Solid State Relay - SSR

Supply voltage	Relay type	Socket type (reference with the 39 Series)				
		Master BASIC (39.10.....)	Master PLUS (39.30.....)	Master INPUT (39.40.....)	Master OUTPUT (39.20.....)	Master TIMER (39.80.....)
12 V AC/DC	34.81.7.012.xxxx	—	—	—	—	93.68.0.024
24 V AC/DC	34.81.7.024.xxxx	—	93.63.0.024	93.64.0.024	—	93.68.0.024
(110...125)V AC/DC*	34.81.7.060.xxxx	—	93.63.3.125	—	—	—
(220...240)V AC*	34.81.7.060.xxxx	—	93.63.3.230	—	—	—
(110...125)V AC/DC	34.81.7.060.xxxx	93.61.0.125	93.63.0.125	93.64.0.125	93.62.0.125	—
(24...240)V AC/DC	34.81.7.024.xxxx	—	93.63.0.240	—	—	—
(220...240)V AC	34.81.7.060.xxxx	93.61.8.230	93.63.8.230	93.64.8.230	93.62.8.230	—
6 V DC	34.81.7.005.xxxx	93.61.7.024	93.63.7.024	93.64.7.024	93.62.7.024	—
12 V DC	34.81.7.012.xxxx	93.61.7.024	93.63.7.024	93.64.7.024	93.62.7.024	—
24 V DC	34.81.7.024.xxxx	93.61.7.024	93.63.7.024	93.64.7.024	93.62.7.024	—
60 V DC	34.81.7.060.xxxx	—	93.63.7.060	—	—	—
(110...125)V DC	34.81.7.060.xxxx	—	93.63.7.125	—	—	—
220 V DC	34.81.7.060.xxxx	—	93.63.7.220	—	—	—

* Leakage current suppression

Approvals
(according to type):





Accessories

16-way jumper link	093.16 (blue), 093.16.0 (black), 093.16.1 (red)
Dual-purpose plastic separator	093.60
Sheet of marker tags	060.48 and 093.48

Technical data

Rated values	6 A - 250 V
Dielectric strength	6 kV (1.2/50 μs) between coil and contacts
Protection category	IP 20
Ambient temperature	°C -40...+70
Screw torque	Nm 0.5
Wire strip length	mm 10
Max wire size	Solid wire and stranded wire
	mm ² 1 x (0.5...2.5) / 2 x 1.5
	AWG 1 x (21...14) / 2 x 16



Push-In terminal socket 35 mm rail mounting (EN 60715)

NEW

Common features

- Space saving 6.2 mm wide
- Connections for 16-way jumper link
- Terminal doubler 093.62
- Integral coil indication and protection circuit
- Secure retention and easy ejection by plastic clip

93.60

For technical data and supply versions, refer to the Master**INTERFACE 39 Series** – “Relay interface module”



93.65

Electromechanical Relay - EMR

Supply voltage	Relay type	Socket type (reference with the 39 Series)				
		Master BASIC (39.01.....)	Master PLUS (39.61.....)	Master INPUT (39.71.....)	Master OUTPUT (39.51.....)	Master TIMER (39.91.....)
6 V AC/DC	34.51.7.005.xx10	93.60.7.024	93.66.7.024	93.67.7.024	93.65.7.024	—
12 V AC/DC	34.51.7.012.xx10	93.60.7.024	93.66.7.024	93.67.7.024	93.65.7.024	93.69.0.024
24 V AC/DC	34.51.7.024.xx10	93.60.7.024	93.66.7.024	93.67.7.024	93.65.7.024	93.69.0.024
60 V AC/DC	34.51.7.060.xx10	—	93.66.7.060	—	—	—
(110...125)V AC/DC*	34.51.7.060.xx10	—	93.66.3.125	—	—	—
(220...240)V AC*	34.51.7.060.xx10	—	93.66.3.230	—	—	—
(110...125)V AC/DC	34.51.7.060.xx10	93.60.0.125	93.66.0.125	93.67.0.125	93.65.0.125	—
(24...240)V AC/DC	34.51.7.024.xx10	—	93.66.0.240	—	—	—
(220...240)V AC	34.51.7.060.xx10	93.60.8.230	93.66.8.230	93.67.8.230	93.65.8.230	—
(110...125)V DC	34.51.7.060.xx10	—	93.66.7.125	—	—	—
220 V DC	34.51.7.060.xx10	—	93.66.7.220	—	—	—

* Leakage current suppression



93.66

Solid State Relay - SSR

Supply voltage	Relay type	Socket type (reference with the 39 Series)				
		Master BASIC (39.00.....)	Master PLUS (39.60.....)	Master INPUT (39.70.....)	Master OUTPUT (39.50.....)	Master TIMER (39.90.....)
12 V AC/DC	34.81.7.012.xxxx	—	—	—	—	93.69.0.024
24 V AC/DC	34.81.7.024.xxxx	—	93.66.0.024	93.67.0.024	—	93.69.0.024
(110...125)V AC/DC*	34.81.7.060.xxxx	—	93.66.3.125	—	—	—
(220...240)V AC*	34.81.7.060.xxxx	—	93.66.3.230	—	—	—
(110...125)V AC/DC	34.81.7.060.xxxx	93.60.0.125	93.66.0.125	93.67.0.125	93.65.0.125	—
(24...240)V AC/DC	34.81.7.024.xxxx	—	93.66.0.240	—	—	—
(220...240)V AC	34.81.7.060.xxxx	93.60.8.230	93.66.8.230	93.67.8.230	93.65.8.230	—
6 V DC	34.81.7.005.xxxx	93.60.7.024	93.66.7.024	93.67.7.024	93.65.7.024	—
12 V DC	34.81.7.012.xxxx	93.60.7.024	93.66.7.024	93.67.7.024	93.65.7.024	—
24 V DC	34.81.7.024.xxxx	93.60.7.024	93.66.7.024	93.67.7.024	93.65.7.024	—
60 V DC	34.81.7.060.xxxx	—	93.66.7.060	—	—	—
(110...125)V DC	34.81.7.060.xxxx	—	93.66.7.125	—	—	—
220 V DC	34.81.7.060.xxxx	—	93.66.7.220	—	—	—

* Leakage current suppression



93.67

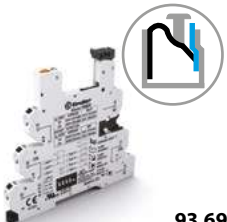

93.69

Approvals
(according to type):



Accessories

16-way jumper link	093.16 (blue), 093.16.0 (black), 093.16.1 (red)
Dual-purpose plastic separator	093.60
Terminal doubler	093.62
Sheet of marker tags	060.48 and 093.48

Technical data

Rated values	6 A - 250 V
Dielectric strength	6 kV (1.2/50 μs) between coil and contacts
Protection category	IP 20
Ambient temperature	°C -40...+70
Wire strip length	mm 8
Max wire size	Solid wire and stranded wire
	mm ² 1 x (0.5...2.5)
	AWG 1 x (21...14)

A

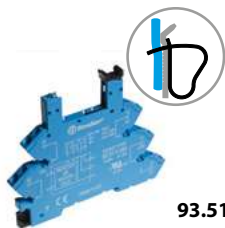

93.51

Screw less terminal socket 35 mm rail mounting (EN 60715)**Common features**

- Space saving 6.2 mm wide
- Connections for 20-way jumper link
- Integral coil indication and protection circuit
- Secure retention and easy ejection by plastic clip

For technical data and supply versions, refer to the **38 Series** – “Relay interface module”

Approvals
(according to type):



RINA cRU[®] US
 Certain relay/socket combinations

Electromechanical Relay - EMR and Solid State Relay - SSR

Supply voltage	Relay type (reference with the 38 Series)		Socket type
	Electromechanical relay - EMR (38.61.....)	Solid State Relay - SSR (38.81.....)	
12 V AC/DC	34.51.7.012.xx10	—	93.51.0.024
24 V AC/DC	34.51.7.024.xx10	—	93.51.0.024
(110...125)V AC/DC	34.51.7.060.xx10	34.81.7.060.xxxx	93.51.0.125
(220...240)V AC/DC	34.51.7.060.xx10	34.81.7.060.xxxx	93.51.0.240
(110...125)V AC/DC*	34.51.7.060.xx10	34.81.7.060.xxxx	93.51.3.125
(220...240)V AC*	34.51.7.060.xx10	34.81.7.060.xxxx	93.51.3.240
(220...240)V AC	34.51.7.060.xx10	34.81.7.060.xxxx	93.51.8.240
12 V DC	34.51.7.012.xx10	34.81.7.012.xxxx	93.51.7.024
24 V DC	34.51.7.024.xx10	34.81.7.024.xxxx	93.51.7.024
60 V DC	34.51.7.060.xx10	34.81.7.060.xxxx	93.51.7.060

* Leakage current suppression

Accessories

20-way jumper link	093.20
Plastic separator	093.01
Sheet of marker tags	093.48

Technical data

Rated values	6 A - 250 V
Dielectric strength	6 kV (1.2/50 μs) between coil and contacts
Protection category	IP 20
Ambient temperature ($U_N \leq 60$ V / > 60 V)	°C -40...+70 / -40...+55
Wire strip length	mm 10
Max wire size	Solid wire and stranded wire
	mm ² 1 x 2.5 / 2 x 1.5
	AWG 1 x 14 / 2 x 16



93.11

Approvals
(according to type):



PCB socket with retaining and release clip	93.11 (blue)
For relay type	34.51, 34.81
Technical data	
Rated values	6 A - 250 V
Dielectric strength	≥ 6 kV (1.2/50 μs) between coil and contacts
Protection category	IP 20
Ambient temperature	°C -40...+70

Retaining and release clip use:

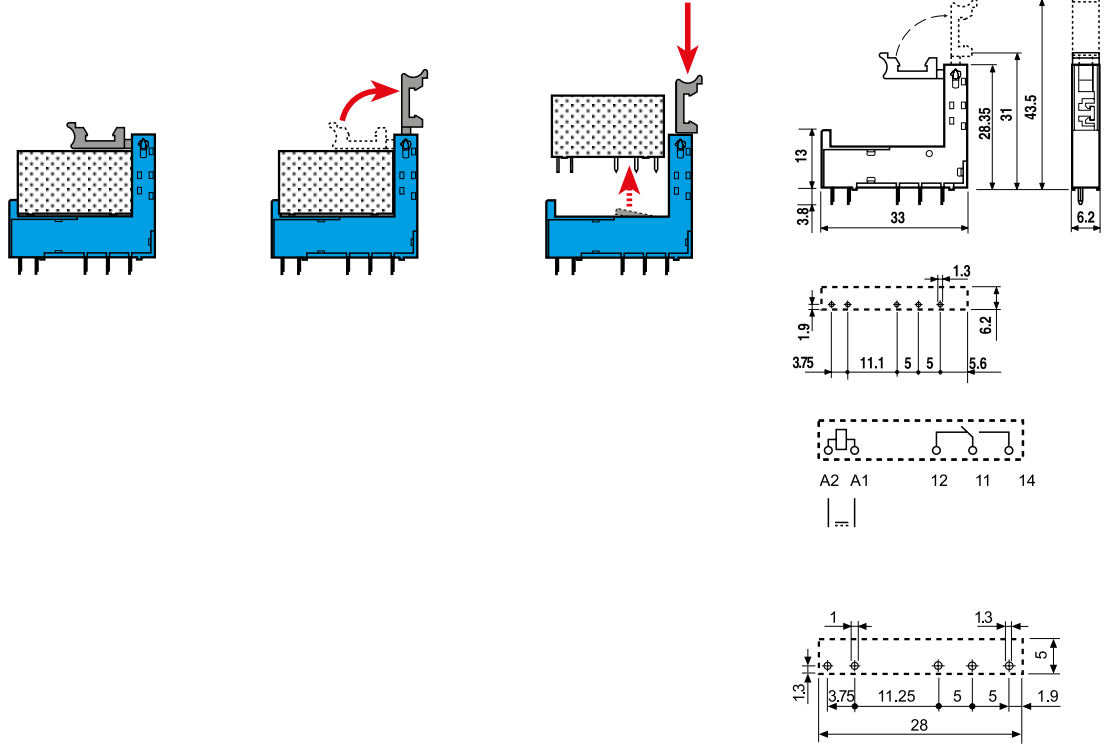



Miniature PCB relays 10 A



Burners, boilers
and furnaces



Jacuzzis and hot tubs



Washing machines



Hi-Fi systems



Refrigerators



Automation for
blinds, grilles
and shutters

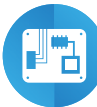

Electronic
circuit boards



Electronic kits

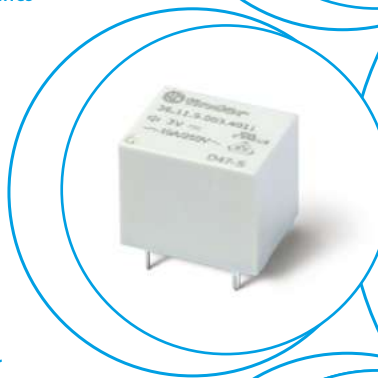

Printed circuit mount 10 A relay

- New smaller size
- 1 Pole changeover contacts
- Miniature - "Sugar cube" package
- DC coil - 360 mW
- Wash tight: RT III
- Cadmium Free contact material
- RoHS conform

36.11-4011



- 1 CO (SPDT), 10 A
- Sugar cube size
- PCB mount

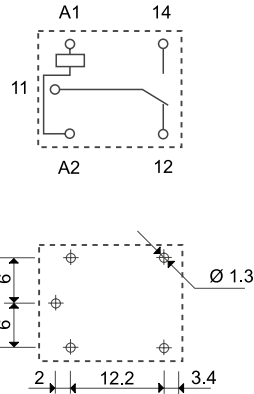
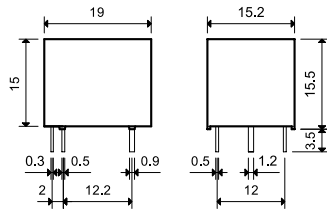

Copper side view

Contact specification

Contact configuration		1 CO (SPDT)
Rated current/Maximum peak current	A	10/15 (NO) - 5/10 (NC)
Rated voltage/ Maximum switching voltage	V AC	250/277
Rated load AC1	VA	2500 (NO) - 1250 (NC)
Rated load AC15 (230 V AC)	VA	500 (NO)
Single phase motor rating (230 V AC)	kW	0.37 (NO)
Breaking capacity DC1: 28 V	A	10 (NO)
Minimum switching load	mW (V/mA)	500 (5/100)
Standard contact material		AgSnO ₂

Coil specification

Nominal voltage (U _N)	V AC (50/60 Hz)	—
	V DC	3 - 5 - 6 - 9 - 12 - 18 - 24 - 48
Rated power AC/DC	VA (50 Hz)/W	—/0.36
Operating range	AC	—
	DC	(0.75...1.3)U _N
Holding voltage	AC/DC	—/0.5 U _N
Must drop-out voltage	AC/DC	—/0.1 U _N

Technical data

Mechanical life AC/DC	cycles	—/10 · 10 ⁶
Electrical life at rated load AC1	cycles	50 · 10 ³
Operate/release time	ms	10/5
Insulation between coil and contacts (1.2/50 μs)	kV	3
Dielectric strength between open contacts	V AC	750
Ambient temperature range	°C	-40...+85
Environmental protection		RT III

Approvals (according to type)



Ordering information

Example: 36 series miniature PCB relay, 1 CO (SPDT) - 10 A contacts, 12 V DC coil.

A

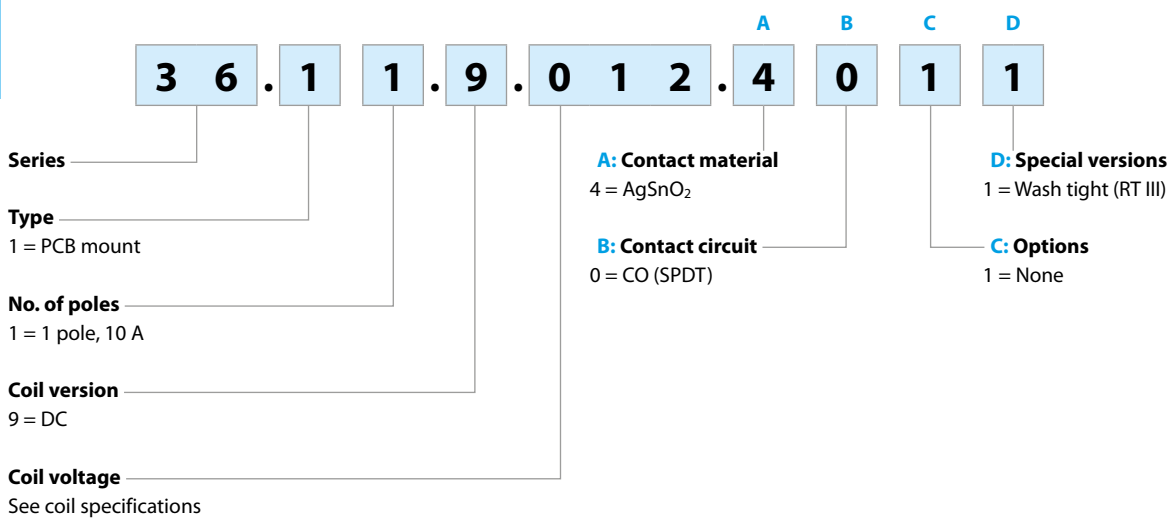

Selecting features and options: only combinations in the same row are possible.

Preferred selections for best availability are shown in **bold**.

Type	Coil version	A	B	C	D
36.11	DC	4	0	1	1

Technical data

Insulation according to EN 61810-1

Nominal voltage of supply system	V AC	230/400
Rated insulation voltage	V AC	250
Pollution degree		2

Insulation between coil and contact set

Type of insulation		Basic
Overvoltage category		II
Rated impulse voltage	kV (1.2/50 μs)	4
Dielectric strength	V AC	2500

Insulation between open contacts

Type of disconnection		Micro-disconnection
Dielectric strength	V AC/kV (1.2/50 μs)	750/1.5

Other data

Shock resistance	g	10
Bounce time: NO/NC	ms	1/6
Vibration resistance (5...55 Hz): NO/NC	g	14/8
Power lost to the environment	without contact current	W 0.4
	with rated current	W 1.4
Recommended distance between relays mounted on PCB	mm	≥ 5

A

Contact specification

F 36 - Electrical life (AC) v contact current

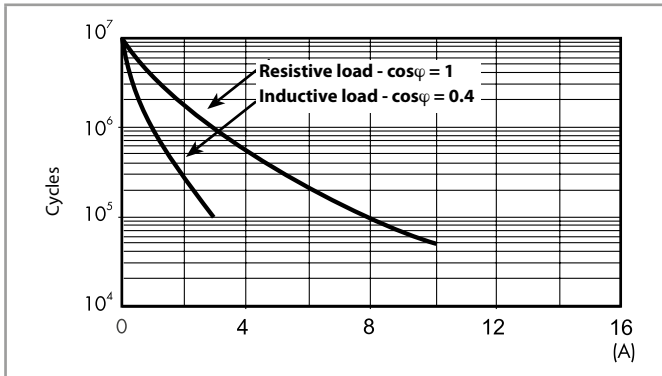

Coil specifications

DC coil data

Nominal voltage U_N V	Coil code	Operating range		Resistance R Ω	Rated coil consumption I at U_N mA
		U_{min} V	U_{max} V		
3	9.003	2.2	3.9	25	120
5	9.005	3.7	6.5	70	72
6	9.006	4.5	7.8	100	60
9	9.009	6.7	11.7	225	40
12	9.012	9	15.6	400	30
18	9.018	13.5	23.4	900	20
24	9.024	18	31.2	1600	15
48	9.048	36	62.4	6400	7.5

R 36 - DC coil operating range v ambient temperature

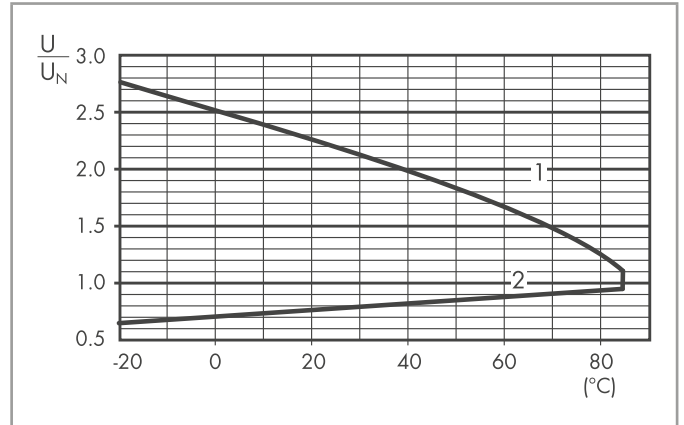

- 1 - Max. permitted coil voltage.
- 2 - Min. pick-up voltage with coil at ambient temperature.



finder[®]
SWITCH TO THE FUTURE

40
SERIES

Miniature PCB Relays 8 - 10 - 12 - 16 A



Medical and
dentistry



Control panels



Panels for electrical
distribution



Toys



Automation for
blinds, grilles
and shutters



Door and gate
openers

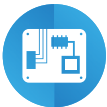

Electronic
circuit boards



Vending
machines



Power relays 1 and 2 pole for direct PCB or socket mount

Type 40.31/51

- 1 CO 12 A (3.5 mm pin pitch)
- 1 CO 12 A (5.0 mm pin pitch)

Type 40.52

- 2 CO 8 A (5.0 mm pin pitch)

Type 40.61

- 1 CO 16 A (5.0 mm pin pitch)

- Pin length 3.5 mm for PCB mount
- Pin length 5.3 mm for Plug-in mount
- DC coils (650 mW or 500 mW)
- Cadmium-free contact material available
- 8 mm Creepage and Clearance, 6 kV (1.2/50µs) between coil and contact
- Meets EN 60335-1 glow wire requirements
- 95 series sockets for PCB or 35 mm rail mounting (EN 60715) with Screw, Screwless or Push-in terminals
- Coil Indication and EMC suppression modules 99 series and Timer module 86.30 options
- Environmental protection:
RT II - flux proof (Standard)
RT III - wash tight (Option)

* Mounted on sockets ≤ 10 A

** With the AgSnO₂ material the maximum peak current is 120 A - 5 ms on normally open contact.

FOR UL RATINGS SEE:
"General technical information" page V

For outline drawing see page 11

40.31/51



- 1 CO 12 A on PCB, 10 A with socket
- 3.5 mm pin pitch (40.31), 5.0 mm pin pitch (40.51)
- PCB or 95 Series socket mount

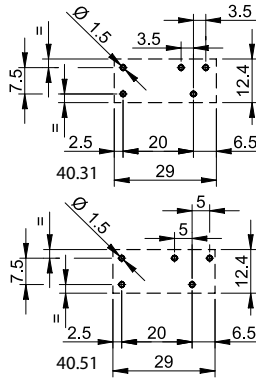
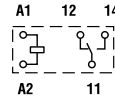

Copper side view

Pin length 3.5 mm for PCB only
Pin length 5.3 mm for PCB or sockets

See ordering information

40.52



- 2 CO 8 A
- 5.0 mm pin pitch
- PCB or 95 Series socket mount

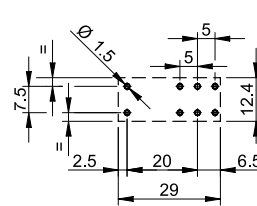
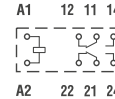

Copper side view

Pin length 3.5 mm for PCB only
Pin length 5.3 mm for PCB or sockets

See ordering information

40.61



- 1 CO 16 A
- 5.0 mm pin pitch
- PCB or 95 Series socket mount

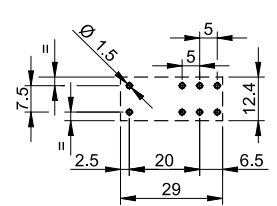
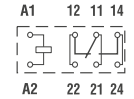

Copper side view

Pin length 3.5 mm for PCB only
Pin length 5.3 mm for PCB or sockets

See ordering information

Contact specification		40.31/51	40.52	40.61
Contact configuration		1 CO (SPDT)	2 CO (DPDT)	1 CO (SPDT)
Rated current/Maximum peak current	A	12*/20	8/15	16/30**
Rated voltage/Maximum switching voltage	V AC	250/400	250/400	250/400
Rated load AC1	VA	3000	2000	4000
Rated load AC15 (230 V AC)	VA	1000	750	1000
Single phase motor rating (230 V AC)	kW	0.55	0.37	0.55
Breaking capacity DC1: 30/110/220 V	A	12/0.6/0.25	8/0.6/0.25	16/0.6/0.25
Minimum switching load	mW (V/mA)	300 (5/5)	300 (5/5)	500 (10/5)
Standard contact material		AgNi	AgNi	AgCdO
Coil specification				
Nominal voltage (U _N)	V AC (50/60 Hz)	—	—	—
	V DC	5 - 6 - 7 - 9 - 12 - 14 - 18 - 21 - 24 - 28 - 36 - 48 - 60 - 90 - 110 - 125		
Rated power DC/sensitive DC	W	0.65/0.5	0.65/0.5	0.65/0.5
Operating range	AC	—	—	—
	DC/sensitive DC	(0.73...1.5)U _N /(0.73...1.5)U _N		
Holding voltage	DC	0.4 U _N	0.4 U _N	0.4 U _N
Must drop-out voltage	DC	0.1 U _N	0.1 U _N	0.1 U _N
Technical data				
Mechanical life	cycles	10 · 10 ⁶	10 · 10 ⁶	10 · 10 ⁶
Electrical life at rated load AC1	cycles	200 · 10 ³	100 · 10 ³	100 · 10 ³
Operate/release time	ms	7/3 (10/3 sensitive)	7/3 (12/4 sensitive)	7/3 (10/3 sensitive)
Insulation between coil and contacts (1.2/50 µs)	kV	6 (8 mm)	6 (8 mm)	6 (8 mm)
Dielectric strength between open contacts	V AC	1000	1000	1000
Ambient temperature range	°C	-40...+85	-40...+85	-40...+85
Environmental protection		RT II***	RT II***	RT II***

Approvals (according to type)



*** See general technical information "Guidelines for automatic flow solder processes" page II.

Power relays 1 and 2 pole for direct PCB or socket mount

Type 40.31/51

- 1 CO 10 A (3.5 mm pin pitch)
- 1 CO 10 A (5.0 mm pin pitch)

Type 40.52

- 2 CO 8 A (5.0 mm pin pitch)

Type 40.61

- 1 CO 16 A (5.0 mm pin pitch)

- AC or DC coils according to type
- Cadmium-free contact material
- 8 mm Creepage and Clearance, 6 kV (1.2/50µs) between coil and contact
- Meets EN 60335-1 glow wire requirements
- 95 series sockets for PCB or 35 mm rail mounting (EN 60715) with Screw, Screwless or Push-in terminals
- Coil Indication and EMC suppression modules 99 series and Timer module 86.30 options
- Environmental protection:
RT II - flux proof (Standard)
RT III - wash tight (Option)

* With the AgSnO₂ material the maximum peak current is 120 A - 5 ms on normally open contact.

FOR UL RATINGS SEE:

"General technical information" page V

For outline drawing see page 11

40.31/51



- 1 CO 10 A
- 3.5 mm pin pitch (40.31), 5.0 mm pin pitch (40.51)
- PCB or 95 Series socket mount

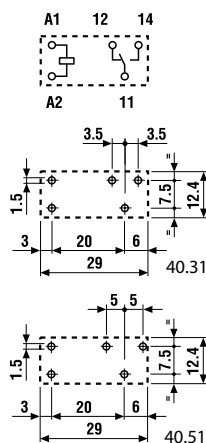

Copper side view
Pin length 5.3 mm for PCB or sockets

40.52



- 2 CO 8 A
- 5.0 mm pin pitch
- PCB or 95 Series socket mount

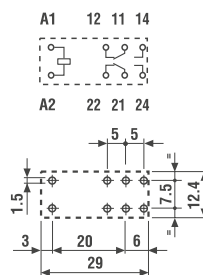

Copper side view
Pin length 5.3 mm for PCB or sockets

40.61



- 1 CO 16 A
- 5.0 mm pin pitch
- PCB or 95 Series socket mount

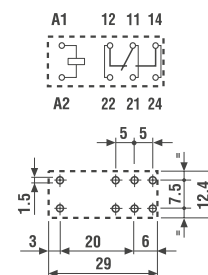

Copper side view
Pin length 5.3 mm for PCB or sockets

Contact specification		40.31/51	40.52	40.61
Contact configuration		1 CO (SPDT)	2 CO (DPDT)	1 CO (SPDT)
Rated current/Maximum peak current	A	10/20	8/15	16/30*
Rated voltage/Maximum switching voltage	V AC	250/400	250/400	250/400
Rated load AC1	VA	2500	2000	4000
Rated load AC15 (230 V AC)	VA	500	400	750
Single phase motor rating (230 V AC)	kW	0.37	0.3	0.55
Breaking capacity DC1: 30/110/220 V	A	10/0.3/0.12	8/0.3/0.12	16/0.3/0.12
Minimum switching load	mW (V/mA)	300 (5/5)	300 (5/5)	500 (10/5)
Standard contact material		AgNi	AgNi	AgCdO
Coil specification				
Nominal voltage (U _N)	V AC (50/60 Hz)	6 - 12 - 24 - 48 - 60 - 110 - 120 - 230 - 240		
	V DC	—		
Rated power AC/DC/sens. DC	VA (50 Hz)/W/W	1.2/—/—	1.2/0.65/0.5	1.2/—/—
Operating range	AC	(0.8...1.1)U _N	(0.8...1.1)U _N	(0.8...1.1)U _N
	DC/sens. DC	—	(0.73...1.5)U _N /(0.73...1.5)U _N	—
Holding voltage	AC/DC	0.8 U _N /—	0.8 U _N /0.4 U _N	0.8 U _N /—
Must drop-out voltage	AC/DC	0.2 U _N /—	0.2 U _N /0.1 U _N	0.2 U _N /—
Technical data				
Mechanical life	cycles	10 · 10 ⁶	10 · 10 ⁶	10 · 10 ⁶
Electrical life at rated load AC1	cycles	200 · 10 ³	100 · 10 ³	100 · 10 ³
Operate/release time	ms	7/3	7/3 - (12/4 sensitive)	7/3
Insulation between coil and contacts (1.2/50 µs)	kV	6 (8 mm)	6 (8 mm)	6 (8 mm)
Dielectric strength between open contacts	V AC	1000	1000	1000
Ambient temperature range	°C	-40...+85	-40...+85	-40...+85
Environmental protection		RT II**	RT II**	RT II**
Approvals (according to type)				

** See general technical information "Guidelines for automatic flow solder processes" page II.

PCB relay

Type 40.11

- 1 CO 10 A - flat pack
- DC (sensitive) coils

Type 40.xx.6

- Bistable versions of the types 40.31, 40.51, 40.52 and 40.61
- Bistable (single coil)
- Cadmium-free contact material available
- 8 mm Creepage and Clearance, 6 kV (1.2/50µs) between coil and contact
- 95 series sockets for PCB or 35 mm rail mounting (EN 60715) with Screw, Screwless or Push-in terminals
- Environmental protection:
RT II - flux proof (Standard)
RT III - wash tight (Option)

FOR UL RATINGS SEE:

"General technical information" page V

For outline drawing see page 11

Contact specification

Contact configuration	1 CO (SPDT)
Rated current/Maximum peak current	A 10/20
Rated voltage/Maximum switching voltage	V AC 250/400
Rated load AC1	VA 2500
Rated load AC15 (230 V AC)	VA 500
Single phase motor rating (230 V AC)	kW 0.37
Breaking capacity DC1: 30/110/220 V	A 10/0.3/0.12
Minimum switching load	mW (V/mA) 300 (5/5)
Standard contact material	AgCdO

Coil specification

Nominal voltage (U _N)	V AC (50/60 Hz)	—	5 - 6 - 12 - 24 - 48 - 110
	V DC	6 - 12 - 24 - 48 - 60	
Rated power AC/DC/sens. DC	VA (50 Hz)/W/W	—/—/0.5	1.0/1.0/—
Operating range	AC	—	(0.8...1.1)U _N
	DC/sens. DC	—/(0.73...1.75)U _N	(0.8...1.1)U _N / —
Holding voltage	AC/DC	—/0.4 U _N	—
Must drop-out voltage	AC/DC	—/0.1 U _N	—

Technical data

Mechanical life	cycles	20 · 10 ⁶	See relays
Electrical life at rated load AC1	cycles	200 · 10 ³	40.31
Operate/release time	ms	12/4	40.51
Insulation between coil and contacts (1.2/50 µs)	kV	6 (8 mm)	40.52
Dielectric strength between open contacts	V AC	1000	40.61
Ambient temperature range	°C	-40...+70	Min. impulse duration
Environmental protection		RT I**	≥ 20 ms

Approvals (according to type)



** See general technical information "Guidelines for automatic flow solder processes" page II.

40.11



- 1 CO 10 A
- PCB mount 12.7 mm high

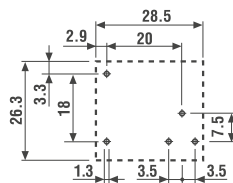
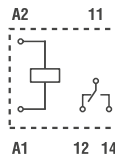

Copper side view

Pin length 3.5 mm for PCB or sockets

40.xx.6



- Bistable (single coil)
- 3.5 or 5.0 mm pin pitch
- PCB or 95 Series socket mount

Bistable version (1 coil) types:

- 40.31.6...
- 40.51.6...
- 40.52.6...
- 40.61.6...

For wiring diagrams see page 10

Pin length 5.3 mm for PCB or sockets

Ordering information

Example: 40 series PCB relay, 2 CO, 230 V AC coil.

A

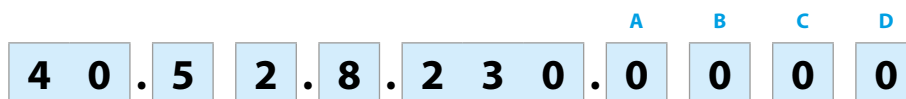

- Series**
Type
1 = PCB - 3.5 mm pinning, flat
3 = PCB/Plug-in - 3.5 mm pinning
5 = PCB/Plug-in - 5 mm pinning
6 = PCB/Plug-in - 5 mm pinning

- No. of poles**
1 = 1 pole
2 = 2 pole

- Coil version**
6 = AC/DC bistable
7 = Sensitive DC, 0.5 W
8 = AC (50/60 Hz)
9 = Standard DC, 0.65 W

Coil voltage
See coil specifications

- A: Contact material**
See table below
B: Contact circuit
0 = CO (nPDT)
3 = NO (nPST)

- D: Special versions**
0 = Standard
1 = Wash tight (RT III)
3 = High temperature (+125 °C) wash tight
C: Options
0 = Pin length 5.3 mm (Plug-in relays)
2 = Pin length 3.5 mm (PCB relays)

Selecting features and options: only combinations in the same row are possible.

Preferred selections for best availability are shown in **bold**.

Terminal pin	Type	Coil version	A	B	C	D
PCB relay, pin length 3.5 mm	40.11	Sensitive DC	2 (AgCdO) - 4 (AgSnO ₂)	0	0	0
	40.31/51	Standard DC/sensitive DC	1 (AgNi)	0 - 3	2	0 - 1
	40.61	Standard DC/sensitive DC	1 (AgNi) - 2 (AgCdO)	0 - 3	2	0 - 1
PCB/Plug-in relay pin length 5.3 mm	40.31/51	AC/sensitive DC	0 (AgNi) - 2 (AgCdO) - 5 (AgNi+Au)	0 - 3	0	0 - 1
	40.31/51	Standard DC	0 (AgNi) - 2 (AgCdO) - 5 (AgNi+Au)	0 - 3	0	0 - 1 - 3
	40.52	AC/sensitive DC	0 (AgNi) - 2 (AgCdO) - 5 (AgNi+Au)	0 - 3	0	0 - 1
	40.52	Standard DC	0 (AgNi) - 2 (AgCdO) - 5 (AgNi+Au)	0 - 3	0	0 - 1 - 3
	40.61	AC/sensitive DC	0 (AgCdO) - 4 (AgSnO ₂)	0 - 3	0	0 - 1
	40.61	Standard DC	0 (AgCdO) - 4 (AgSnO ₂)	0 - 3	0	0 - 1 - 3
	40.31/51/52	Bistable	0 (AgNi)	0	0	0
40.61	Bistable	0 (AgCdO)	0	0	0	

Technical data

Insulation according to EN 61810-1				
		1 pole		2 pole
Nominal voltage of supply system	V AC	230/400		230/400
Rated insulation voltage	V AC	250	400	250 400
Pollution degree		3	2	3 2
Insulation between coil and contact set				
Type of insulation		Reinforced (8 mm)		Reinforced (8 mm)
Overvoltage category		III		III
Rated impulse voltage	kV (1.2/50 µs)	6		6
Dielectric strength	V AC	4000		4000
Insulation between adjacent contacts				
Type of insulation		—		Basic
Overvoltage category		—		II
Rated impulse voltage	kV (1.2/50 µs)	—		2.5
Dielectric strength	V AC	—		2000
Insulation between open contacts				
Type of disconnection		Micro-disconnection		Micro-disconnection
Dielectric strength	V AC/kV (1.2/50 µs)	1000/1.5		1000/1.5
Insulation between coil terminals				
Rated impulse voltage (surge) differential mode (according to EN 61000-4-5)	kV(1.2/50 µs)	2		
Other data				
Bounce time: NO/NC	ms	2/5		
Vibration resistance (10...150)Hz: NO/NC	g	20/5 (1 changeover)		14/2 (2 changeover)
Shock resistance NO/NC	g	20/13 (1 changeover)		20/12 (2 changeover)
Power lost to the environment	without contact current	W	0.65	
	with rated current	W	1.2 (40.11/31/51)	2 (40.61/52)
Recommended distance between relays mounted on PCB	mm	≥ 5		

A

Contact specification

F 40.1 - Electrical life (AC) v contact current

Types 40.31/51/61 (page 3)

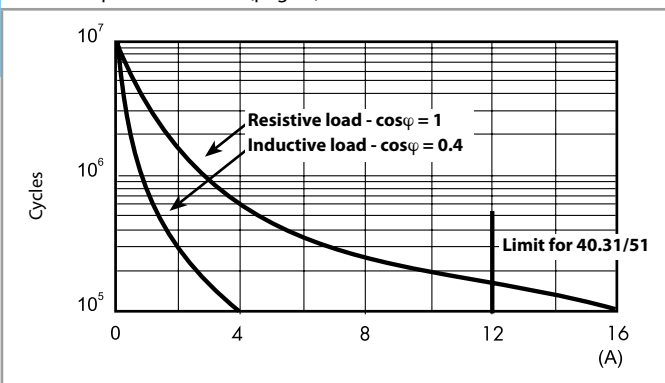

F 40.2 - Electrical life (AC) v contact current

Type 40.52 (page 3)

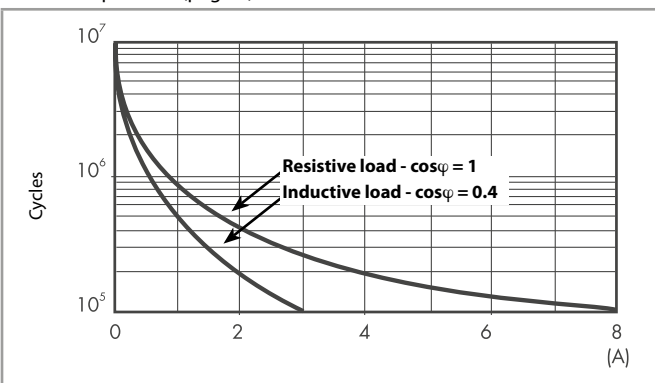

F 40.3 - Electrical life (AC) v contact current

Types 40.31/51/61 (page 4)

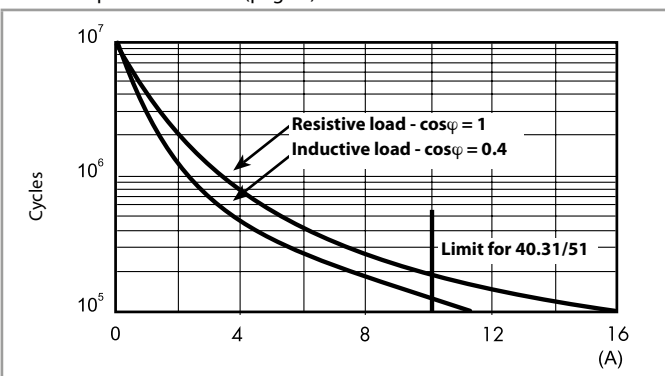

F 40.4 - Electrical life (AC) v contact current

Type 40.52 (page 4)

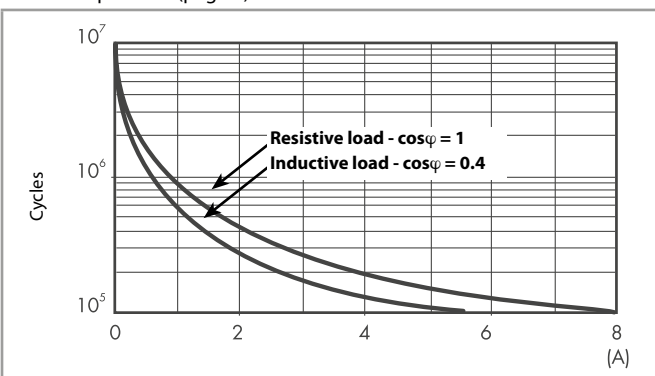

F 40.5 - Electrical life (AC) v contact current

Type 40.11 (page 5)

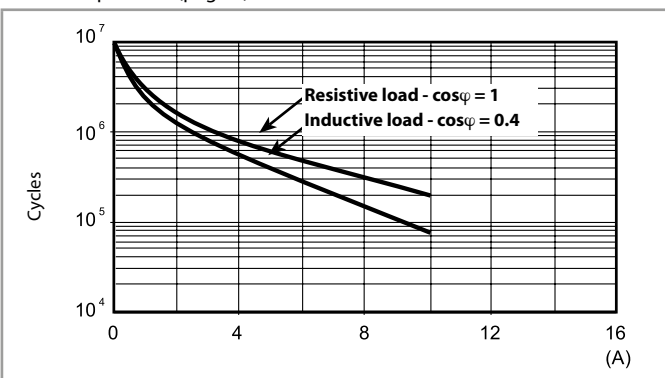

H 40.1 - Maximum DC1 breaking capacity

Types 40.31/51/52/61 (page 3)

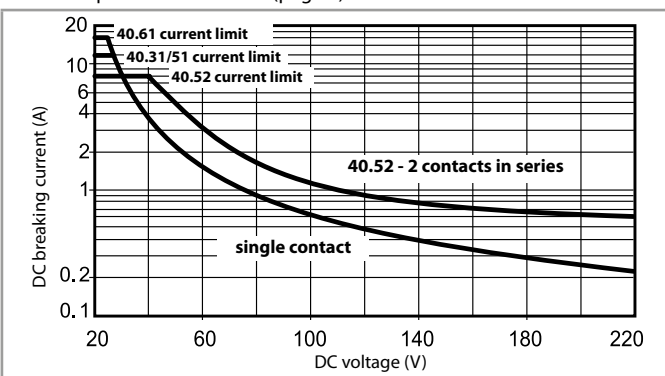

H 40.2 - Maximum DC1 breaking capacity

Types 40.31/51/52/61 (page 4) and 40.11 (page 5)

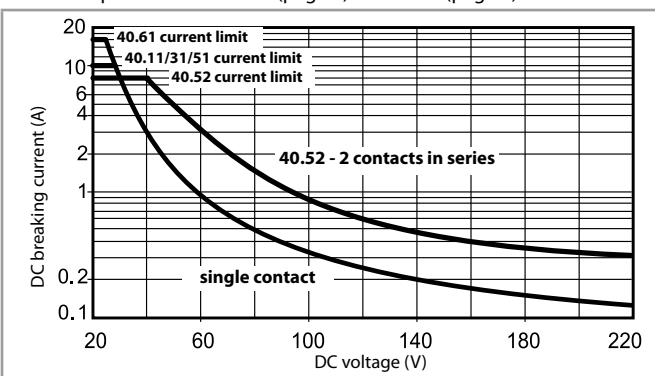

- When switching a resistive load (DC1) having voltage and current values under the curve, an electrical life of $\geq 100 \cdot 10^3$ can be expected.
- In the case of DC13 loads, the connection of a diode in parallel with the load will permit a similar electrical life as for a DC1 load.
Note: the release time for the load will be increased.

Coil specifications

DC coil data - 0.65 W standard (types 40.31/51/52/61)

Nominal voltage U_N V	Coil code	Operating range		Resistance R Ω	Rated coil consumption I at U_N mA
		U_{min} V	U_{max} V		
5	9.005	3.65	7.5	38	130
6	9.006	4.4	9	55	109
7	9.007	5.1	10.5	75	94
9	9.009	6.6	13.5	125	72
12	9.012	8.8	18	220	55
14	9.014	10.2	21	300	47
18	9.018	13.1	27	500	36
21	9.021	15.3	31.5	700	30
24	9.024	17.5	36	900	27
28	9.028	20.5	42	1200	23
36	9.036	26.3	54	2000	18
48	9.048	35	72	3500	14
60	9.060	43.8	90	5500	11
90	9.090	65.7	135	12500	7.2
110	9.110	80.3	165	18000	6.2
125	9.125	91.2	188	23500	5.3

DC coil data - 0.5 W sensitive (types 40.31/51/52/61)

Nominal voltage U_N V	Coil code	Operating range		Resistance R Ω	Rated coil consumption I at U_N mA
		U_{min} V	U_{max} V		
5	7.005	3.7	7.5	50	100
6	7.006	4.4	9	75	80
7	7.007	5.1	10.5	100	70
9	7.009	6.6	13.5	160	56
12	7.012	8.8	18	288	42
14	7.014	10.2	21	400	35
18	7.018	13.2	27	650	27.7
21	7.021	15.4	31.5	900	23.4
24	7.024	17.5	36	1150	21
28	7.028	20.5	42	1600	17.5
36	7.036	26.3	54	2600	13.8
48	7.048	35	72	4800	10
60	7.060	43.8	90	7200	8.4
90	7.090	65.7	135	16200	5.6
110	7.110	80.3	165	23500	4.7
125	7.125	91.2	188	32000	3.9

* $U_{min} = 0.8 U_N$ for 40.61

DC coil data - 0.5 W sensitive (types 40.11)

Nominal voltage U_N V	Coil code	Operating range		Resistance R Ω	Rated coil consumption I at U_N mA
		U_{min} V	U_{max} V		
6	7.006	4.4	10.5	75	80
12	7.012	8.8	21	300	40
24	7.024	17.5	42	1200	20
48	7.048	35	84	4600	10.4
60	7.060	43.8	105	7200	8.3

AC coil data (types 40.31/51/52/61)

Nominal voltage U_N V	Coil code	Operating range		Resistance R Ω	Rated coil consumption I at U_N (50 Hz) mA
		U_{min} V	U_{max} V		
6	8.006	4.8	6.6	21	168
12	8.012	9.6	13.2	80	90
24	8.024	19.2	26.4	320	45
48	8.048	38.4	52.8	1350	21
60	8.060	48	66	2100	16.8
110	8.110	88	121	6900	9.4
120	8.120	96	132	9000	8.4
230	8.230	184	253	28000	5
240	8.240	192	264	31500	4.1

AC/DC coil data - bistable (types 40.31/51/52/61)

Nominal voltage U_N V	Coil code	Operating range		Resistance R Ω	Rated coil consumption I at U_N mA	DC: Release resistance** R_{DC} Ω
		U_{min} V	U_{max} V			
5	6.005	4	5.5	23	215	37
6	6.006	4.8	6.6	33	165	62
12	6.012	9.6	13.2	130	83	220
24	6.024	19.2	26.4	520	40	910
48	6.048	38.4	52.8	2100	21	3,600
110	6.110	88	121	11000	10	16,500

** $R_{DC} =$ Resistance in DC, $R_{AC} = 1.3 \times R_{DC} \ 1 \ W$

Contact specification

R 40 - DC coil operating range v ambient temperature
Standard coil

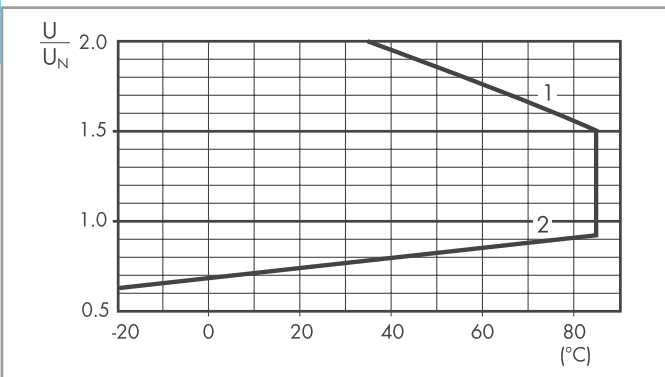

R 40 - DC coil operating range v ambient temperature
Sensitive coil, types 40.31/51/52/61

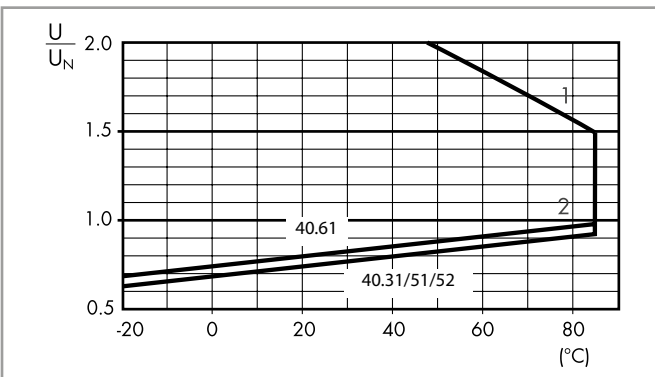

R 40 - DC coil operating range v ambient temperature
Sensitive coil, type 40.11

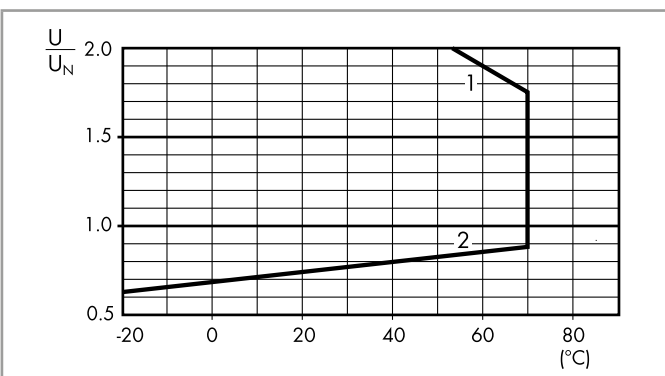

R 40 - AC coil operating range v ambient temperature

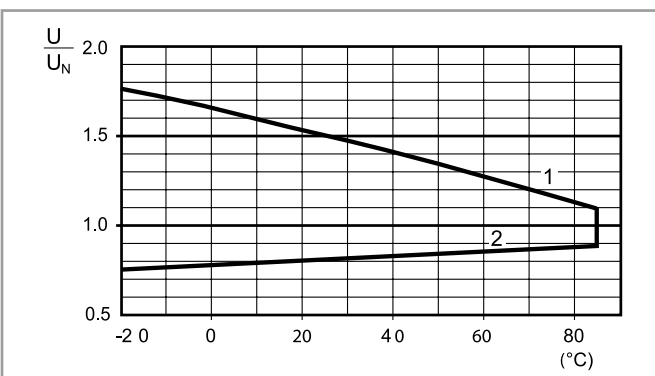

- 1 - Max. permitted coil voltage.
- 2 - Min. pick-up voltage with coil at ambient temperature.

- 1 - Max. permitted coil voltage.
- 2 - Min. pick-up voltage with coil at ambient temperature.

Wiring diagram for 40 series bistable coil version

AC Operation

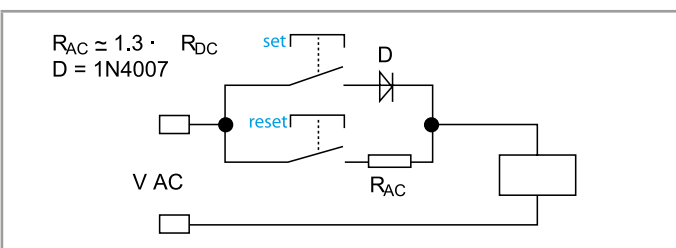

On momentary closure of the SET switch the relay is magnetised through the diode and the relay contacts transfer to the set position and remain in this position.

On momentary closure of the RESET switch the relay is demagnetised through limiting resistor (R_{AC}) and the contacts return to the reset position.

DC Operation

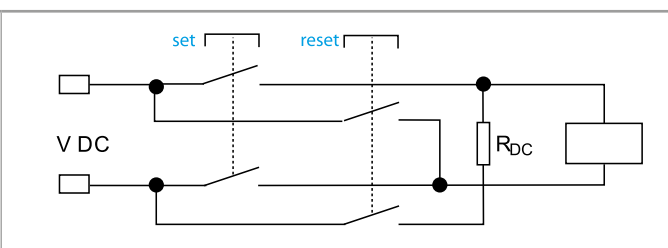

On momentary closure of the SET switch the relay is magnetised and the relay contacts transfer to the set position and remain in this position.

On momentary closure of the RESET switch the relay is demagnetised through limiting resistor (R_{DC}) and the contacts return to the reset position.

Notes: The minimum SET or RESET impulse time is 20 ms. The maximum time can be continuous. In practice, always ensure that the SET and RESET contacts cannot be operated simultaneously.

Outline drawings

Type 40.31/51/52/61 (page 3)

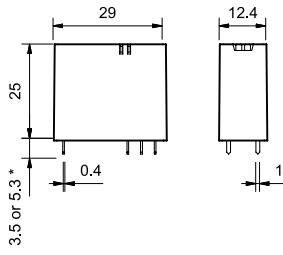

Type 40.31/51/52/61 (page 4)

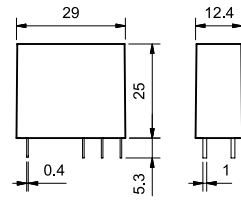

Type 40.11 (page 5)

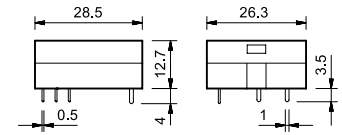

* (3.5 or 5.3 mm) see ordering code

A

A



95.P5
See page 13



Module	Socket	Relay	Description	Mounting	Accessories
99.02	95.P3	40.31	Push-in terminal sockets - For fast cable connection - Top terminals - Contacts - Bottom terminals - Coil	Panel or 35 mm rail (EN 60715) mount	<ul style="list-style-type: none"> - Coil indication and EMC suppression modules - Jumper link - Timer modules - Plastic retaining and release clip
	95.P5	40.51 40.52 40.61			



95.05
See page 15



Module	Socket	Relay	Description	Mounting	Accessories
99.02	95.03	40.31	Screw terminal (Box clamp) socket - Top terminals - Contacts - Bottom terminals - Coil	Panel or 35 mm rail (EN 60715) mount	<ul style="list-style-type: none"> - Coil indication and EMC suppression modules - Jumper link - Timer modules - Plastic retaining and release clip
	95.05	40.51 40.52 40.61			



95.55
See page 16



Module	Socket	Relay	Description	Mounting	Accessories
99.02	95.55	40.51 40.52 40.61	Screwless terminal socket - Top terminals - Contacts - Bottom terminals - Coil	Panel or 35 mm rail (EN 60715) mount	<ul style="list-style-type: none"> - Coil indication and EMC suppression modules - Timer modules - Plastic retaining and release clip



95.85.3
See page 17



Module	Socket	Relay	Description	Mounting	Accessories
99.80	95.83.3	40.31	Screw terminal (Box clamp) socket - Top terminals - NO and COM Contacts - Bottom terminals - Coil and NC Contacts	Panel or 35 mm rail (EN 60715) mount	<ul style="list-style-type: none"> - Coil indication and EMC suppression modules - Jumper link - Plastic retaining and release clip
	95.85.3	40.51 40.52 40.61			



95.95.3
See page 18



Module	Socket	Relay	Description	Mounting	Accessories
99.80	95.93.3	40.31	Screw terminal (Box clamp) socket - Top terminals - Contacts - Bottom terminals - Coil	Panel or 35 mm rail (EN 60715) mount	<ul style="list-style-type: none"> - Coil indication and EMC suppression modules - Jumper link - Plastic retaining and release clip
	95.95.3	40.51 40.52 40.61			



95.65
See page 19



Module	Socket	Relay	Description	Mounting	Accessories
99.01	95.63	40.31	Screw terminal (Box clamp) socket - Top terminals - Contacts - Bottom terminals - Coil	Panel or 35 mm rail (EN 60715) mount	- Metal retaining clip
	95.65	40.51 40.52 40.61			



95.13.2
See page 20

Module	Socket	Relay	Description	Mounting	Accessories
—	95.13.2	40.31	PCB socket	PCB mounting	<ul style="list-style-type: none"> - Metal retaining clip - Plastic retaining clip
—	95.15.2	40.51 40.52 40.61			



95.P5
Approvals
(according to type):
CE **UL** **CSA** **RU** **US**
RINA



095.91.3

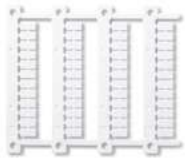

060.48

Push-in terminals socket panel or 35 mm rail mount		95.P3	95.P5
For relay type		40.31	40.51, 40.52, 40.61
Accessories			
Metal retaining clip			095.71
Plastic retaining and release clip (supplied with socket - packaging code SPA)			095.91.3
8-way jumper link			097.58
2-way jumper link (12.5 mm pitch)			097.52
2-way jumper link (4.6 mm pitch)			097.42
Marker tag holder (for tags 060.48 type)			097.00
Identification tag			095.00.4
Modules (see table below)			99.02
Timer modules (see table below)			86.30
Sheet of marker tags for plastic retaining and release clip 095.91.3 and for marker tag holder 097.00, 48 tags, 6 x 12 mm, for CEMBRE thermal transfert printer			060.48
Technical data			
Rated values		10 A - 250 V*	
Dielectric strength		6 kV (1.2/50 µs) between coil and contacts	
Protection category		IP 20	
Ambient temperature		°C -40...+70 (see diagram L95)	
Wire strip length		mm 8	
Min. wire size for 95.P3 and 95.P5 sockets		solid wire	stranded wire
		mm ² 0.5	0.5
Max. wire size for 95.P3 and 95.P5 sockets		AWG 21	21
		solid wire	stranded wire
		mm ² 2 x 1.5 / 1 x 2.5	2 x 1.5 / 1 x 2.5
		AWG 2 x 16 / 1 x 14	2 x 16 / 1 x 14

* For currents > 10 A, contact terminals must be connected in parallel (21 with 11, 24 with 14, 22 with 12).
With the relay 40.51 the change-over contact will be 21-12-14.

L 95 - Total socket current v ambient temperature

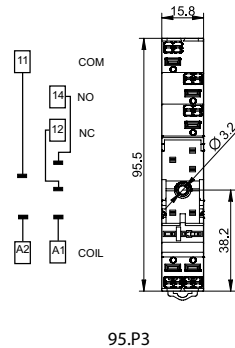
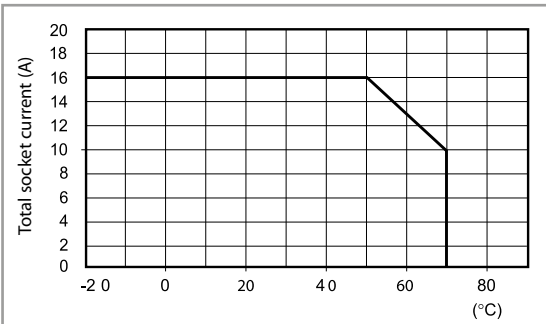

95.P3

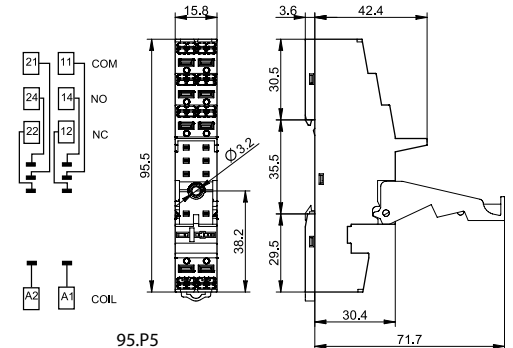

95.P5



097.58

8-way jumper link for 95.P3 and 95.P5 sockets	097.58
Rated values	10 A - 250 V

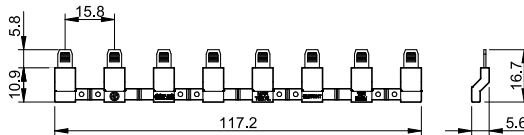

097.52

2-way jumper link for 95.P3 and 95.P5 sockets	097.52
Rated values	10 A - 250 V

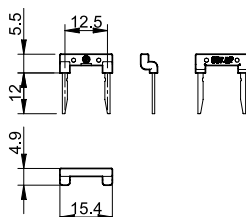

A



097.42

2-way jumper link for 95.P3 and 95.P5 sockets	097.42
Rated values	10 A - 250 V

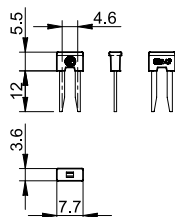

097.00

Marker tag holder for 95.P3 and 95.P5 sockets	097.00
--	--------

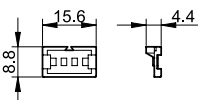

86.30

86 series timer modules	
(12...24)V AC/DC; Bi-function: AI, DI; (0.05 s...100 h)	86.30.0.024.0000
(110...125)V AC; Bi-function: AI, DI; (0.05 s...100 h)	86.30.8.120.0000
(230...240)V AC; Bi-function: AI, DI; (0.05 s...100 h)	86.30.8.240.0000

Approvals (according to type): **CE EAC cRU[®] US**



99.02

Approvals
(according to type):

EAC cRU[®] US

DC Modules with
non-standard polarity
(+A2) on request.

99.02 coil indication and EMC suppression modules for 95.P3 and 95.P5 sockets		
Diode (+A1, standard polarity)	(6...220)V DC	99.02.3.000.00
LED	(6...24)V DC/AC	99.02.0.024.59
LED	(28...60)V DC/AC	99.02.0.060.59
LED	(110...240)V DC/AC	99.02.0.230.59
LED + Diode (+A1, standard polarity)	(6...24)V DC	99.02.9.024.99
LED + Diode (+A1, standard polarity)	(28...60)V DC	99.02.9.060.99
LED + Diode (+A1, standard polarity)	(110...220)V DC	99.02.9.220.99
LED + Varistor	(6...24)V DC/AC	99.02.0.024.98
LED + Varistor	(28...60)V DC/AC	99.02.0.060.98
LED + Varistor	(110...240)V DC/AC	99.02.0.230.98
RC circuit	(6...24)V DC/AC	99.02.0.024.09
RC circuit	(28...60)V DC/AC	99.02.0.060.09
RC circuit	(110...240)V DC/AC	99.02.0.230.09
Residual current by-pass	(110...240)V AC	99.02.8.230.07



95.05
Approvals
(according to type):



95.01

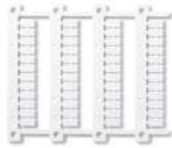

95.03

Screw terminal (Box clamp) socket panel or 35 mm rail mount	95.03 (blue)	95.03.0 (black)	95.05 (blue)	95.05.0 (black)
For relay type	40.31		40.51, 40.52, 40.61	
Accessories				
Metal retaining clip			095.71	
Plastic retaining and release clip (supplied with socket - packaging code SPA)	095.01	095.01.0	095.01	095.01.0
8-way jumper link	095.18	095.18.0	095.18	095.18.0
Marker tag holder (for tags 060.48 type)			097.00	
Identification tag			095.00.4	
Modules (see table below)			99.02	
Timer modules (see table below)			86.30	
Sheet of marker tags for plastic retaining and release clip 095.01 and for marker tag holder 097.00, 48 tags, 6 x 12 mm, for CEMBRE thermal transfer printers			060.48	
Technical data				
Rated values	10 A - 250 V*			
Dielectric strength	6 kV (1.2/50 μs) between coil and contacts			
Protection category	IP 20			
Ambient temperature	°C	-40...+70 (see diagram L95)		
⊕ Screw torque	Nm	0.5		
Wire strip length	mm	8		
Max. wire size for 95.03 and 95.05 sockets		solid wire	stranded wire	
	mm ²	1 x 6 / 2 x 2.5	1 x 4 / 2 x 2.5	
	AWG	1 x 10 / 2 x 14	1 x 12 / 2 x 14	

* For currents > 10 A, contact terminals must be connected in parallel (21 with 11, 24 with 14, 22 with 12).
With the relay 40.51 the change-over contact will be 21-12-14.

L 95 - Total socket current v ambient temperature

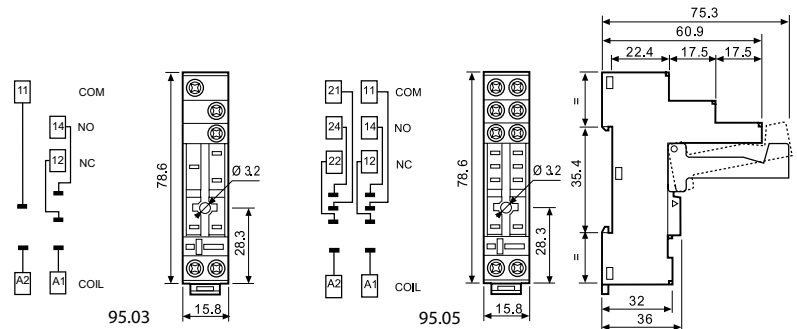
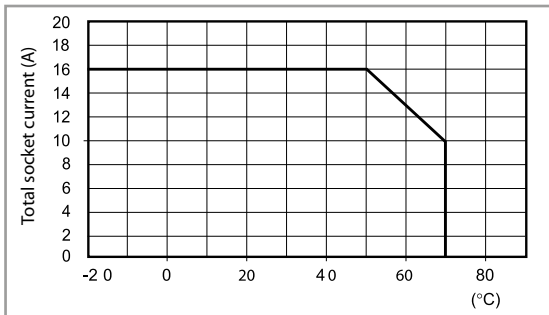

95.18

8-way jumper link for 95.03 and 95.05 sockets	95.18 (blue)	95.18.0 (black)
Rated values	10 A - 250 V	

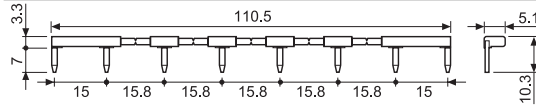

86.30

86 series timer modules	
(12...24)V AC/DC; Bi-function: AI, DI; (0.05 s...100 h)	86.30.0.024.0000
(110...125)V AC; Bi-function: AI, DI; (0.05 s...100 h)	86.30.8.120.0000
(230...240)V AC; Bi-function: AI, DI; (0.05 s...100 h)	86.30.8.240.0000

Approvals (according to type):



99.02

99.02 coil indication and EMC suppression modules for 95.03 and 95.05 sockets		
Diode (+A1, standard polarity)	(6...220)V DC	99.02.3.000.00
LED	(6...24)V DC/AC	99.02.0.024.59
LED	(28...60)V DC/AC	99.02.0.060.59
LED	(110...240)V DC/AC	99.02.0.230.59
LED + Diode (+A1, standard polarity)	(6...24)V DC	99.02.9.024.99
LED + Diode (+A1, standard polarity)	(28...60)V DC	99.02.9.060.99
LED + Diode (+A1, standard polarity)	(110...220)V DC	99.02.9.220.99
LED + Varistor	(6...24)V DC/AC	99.02.0.024.98
LED + Varistor	(28...60)V DC/AC	99.02.0.060.98
LED + Varistor	(110...240)V DC/AC	99.02.0.230.98
RC circuit	(6...24)V DC/AC	99.02.0.024.09
RC circuit	(28...60)V DC/AC	99.02.0.060.09
RC circuit	(110...240)V DC/AC	99.02.0.230.09
Residual current by-pass	(110...240)V AC	99.02.8.230.07

Approvals
(according to type):



DC Modules with non-standard polarity (+A2) on request.

A



95.55

Approvals (according to type):



095.91.3

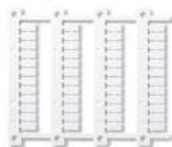

060.48

Screwless terminal socket panel or 35 mm rail mount	95.55 (blue)	95.55.0 (black)
For relay type	40.51, 40.52, 40.61	
Accessories		
Metal retaining clip	095.71	
Plastic retaining and release clip (supplied with socket - packaging code SPA)	095.91.3	
Modules (see table below)	99.02	
Timer modules (see table below)	86.30	
Sheet of marker tags for plastic retaining and release clip 095.91.3, 48 tags, 6 x 12 mm, for CEMBRE thermal transfer printers	060.48	
Technical data		
Rated values	10 A - 250 V*	
Dielectric strength	6 kV (1.2/50 μs) between coil and contacts	
Protection category	IP 20	
Ambient temperature	°C -25...+70 (see diagram L95)	
Wire strip length	mm 8	
Max. wire size for 95.55 socket	solid wire	stranded wire
	mm ² 2 x (0.5...1.5)	2 x (0.5...1.5)
	AWG 2 x (21...18)	2 x (21...18)

* For currents > 10 A, contact terminals must be connected in parallel (21 with 11, 24 with 14, 22 with 12).
With the relay 40.51 the change-over contact will be 21-12-14.

L 95 - Total socket current v ambient temperature

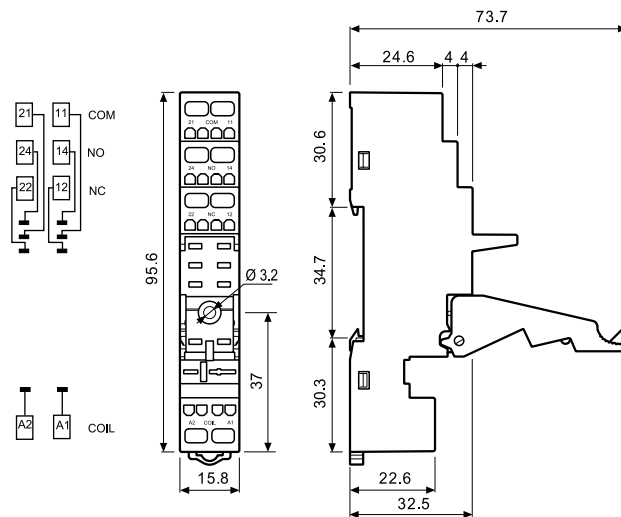
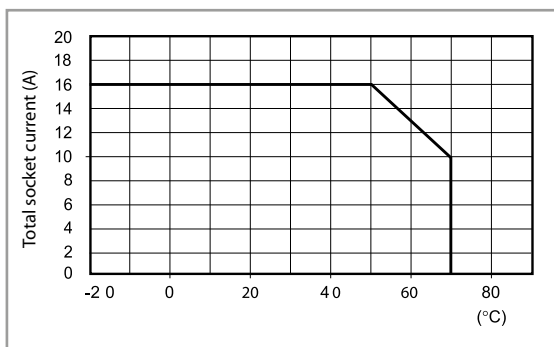

86.30

86 series timer modules		
(12...24)V AC/DC; Bi-function: AI, DI; (0.05 s...100 h)	86.30.0.024.0000	
(110...125)V AC; Bi-function: AI, DI; (0.05 s...100 h)	86.30.8.120.0000	
(230...240)V AC; Bi-function: AI, DI; (0.05 s...100 h)	86.30.8.240.0000	

Approvals (according to type):



99.02

Approvals (according to type):



99.02 coil indication and EMC suppression modules for 95.55 socket		
Diode (+A1, standard polarity)	(6...220)V DC	99.02.3.000.00
LED	(6...24)V DC/AC	99.02.0.024.59
LED	(28...60)V DC/AC	99.02.0.060.59
LED	(110...240)V DC/AC	99.02.0.230.59
LED + Diode (+A1, standard polarity)	(6...24)V DC	99.02.9.024.99
LED + Diode (+A1, standard polarity)	(28...60)V DC	99.02.9.060.99
LED + Diode (+A1, standard polarity)	(110...220)V DC	99.02.9.220.99
LED + Varistor	(6...24)V DC/AC	99.02.0.024.98
LED + Varistor	(28...60)V DC/AC	99.02.0.060.98
LED + Varistor	(110...240)V DC/AC	99.02.0.230.98
RC circuit	(6...24)V DC/AC	99.02.0.024.09
RC circuit	(28...60)V DC/AC	99.02.0.060.09
RC circuit	(110...240)V DC/AC	99.02.0.230.09
Residual current by-pass	(110...240)V AC	99.02.8.230.07

DC Modules with non-standard polarity (+A2) on request.

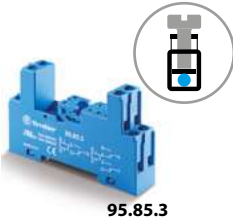

95.85.3

Approvals
(according to type):



095.91.3

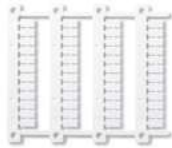

060.48

Screw terminal (Box clamp) socket panel or 35 mm rail mount	95.83.3 (blue)	95.83.30 (black)	95.85.3 (blue)	95.85.30 (black)
For relay type	40.31		40.51, 40.52, 40.61	
Accessories				
Metal retaining clip	095.71			
Plastic retaining and release clip (supplied with socket - packaging code SPA)	095.91.3	095.91.30	095.91.3	095.91.30
8-way jumper link	095.08	095.08.0	095.08	095.08.0
Identification tag	095.00.4			
Modules (see table below)	99.80			
Marker tag holder	097.00			
Sheet of marker tags for plastic retaining and release clip 095.91.3, 48 tags, 6 x 12 mm, for CEMBRE thermal transfert printer	060.48			
Technical data				
Rated values	10 A - 250 V*			
Dielectric strength	6 kV (1.2/50 μs) between coil and contacts (95.83.3 only)			
Protection category	IP 20			
Ambient temperature	°C -40...+70 (see diagram L95)			
Screw torque	Nm	0.5		
Wire strip length	mm	7		
Max. wire size for 95.83.3 and 95.85.3 sockets		solid wire	stranded wire	
	mm ²	1 x 6 / 2 x 2.5	1 x 4 / 2 x 2.5	
	AWG	1 x 10 / 2 x 14	1 x 12 / 2 x 14	

* For currents > 10 A, contact terminals must be connected in parallel (21 with 11, 24 with 14, 22 with 12).
With the relay 40.51 the change-over contact will be 21-12-14.

L 95 - Total socket current v ambient temperature

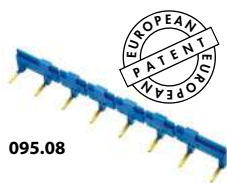
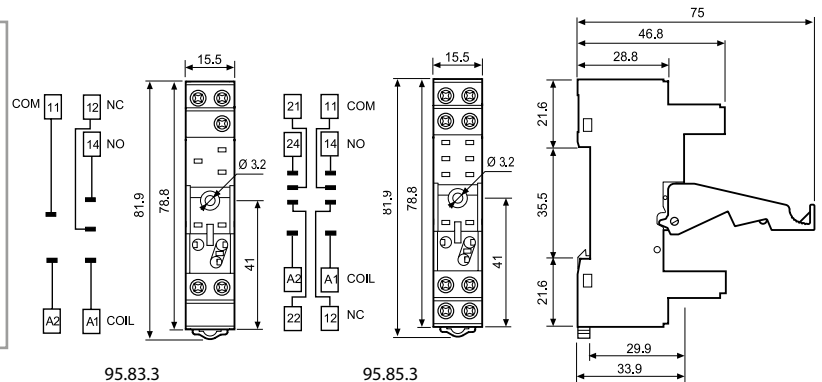
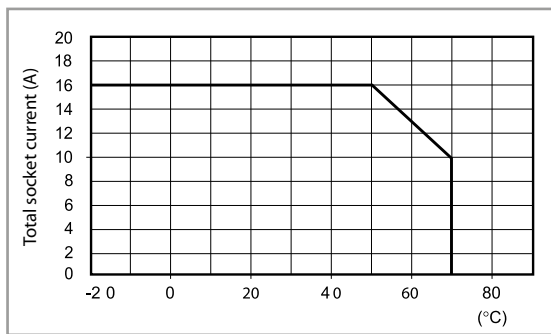

095.08



8-way jumper link for 95.83.3 and 95.85.3 sockets	095.08 (blue)	095.08.0 (black)
Rated values	10 A - 250 V	

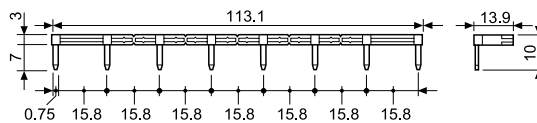

99.80

Approvals
(according to type):



* Modules in Black housing are available on request.

Green LED is standard.
Red LED available on request.

99.80 coil indication and EMC suppression modules for 95.83.3 and 95.85.3 sockets		Blue*
Diode (+A1, standard polarity)	(6...220)V DC	99.80.3.000.00
LED	(6...24)V DC/AC	99.80.0.024.59
LED	(28...60)V DC/AC	99.80.0.060.59
LED	(110...240)V DC/AC	99.80.0.230.59
LED + Diode (+A1, standard polarity)	(6...24)V DC	99.80.9.024.99
LED + Diode (+A1, standard polarity)	(28...60)V DC	99.80.9.060.99
LED + Diode (+A1, standard polarity)	(110...220)V DC	99.80.9.220.99
LED + Varistor	(6...24)V DC/AC	99.80.0.024.98
LED + Varistor	(28...60)V DC/AC	99.80.0.060.98
LED + Varistor	(110...240)V DC/AC	99.80.0.230.98
RC circuit	(6...24)V DC/AC	99.80.0.024.09
RC circuit	(28...60)V DC/AC	99.80.0.060.09
RC circuit	(110...240)V DC/AC	99.80.0.230.09
Residual current by-pass	(110...240)V AC	99.80.8.230.07

A

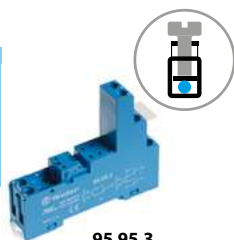

95.93.3

Approvals
(according to type):



095.91.3

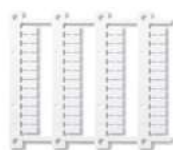

060.48

Screw (Box clamp) terminal socket panel or 35 mm rail mount	95.93.3 (blue)	95.93.30 (black)	95.95.3 (blue)	95.95.30 (black)
For relay type	40.31		40.51, 40.52, 40.61	
Accessories				
Metal retaining clip			095.71	
Plastic retaining and release clip (supplied with socket - packaging code SPA)	095.91.3	095.91.30	095.91.3	095.91.30
8-way jumper link	095.08	095.08.0	095.08	095.08.0
Identification tag			095.00.4	
Modules (see table below)			99.80	
Sheet of marker tags for plastic retaining and release clip 095.91.3 and for marker tag holder 097.00, 48 tags, 6 x 12 mm, for CEMBRE thermal transfer printers			060.48	
Technical data				
Rated values	10 A - 250 V*			
Dielectric strength	6 kV (1.2/50 μs) between coil and contacts			
Protection category	IP 20			
Ambient temperature	°C -40...+70 (see diagram L95)			
Screw torque	Nm	0.5		
Wire strip length	mm	8		
Max. wire size for 95.93.3 and 95.95.3 sockets		solid wire	stranded wire	
	mm ²	1 x 6 / 2 x 2.5		1 x 4 / 2 x 2.5
	AWG	1 x 10 / 2 x 14		1 x 12 / 2 x 14

* For currents > 10 A, contact terminals must be connected in parallel (21 with 11, 24 with 14, 22 with 12).
With the relay 40.51 the change-over contact will be 21-12-14.

L 95 - Total socket current v ambient temperature

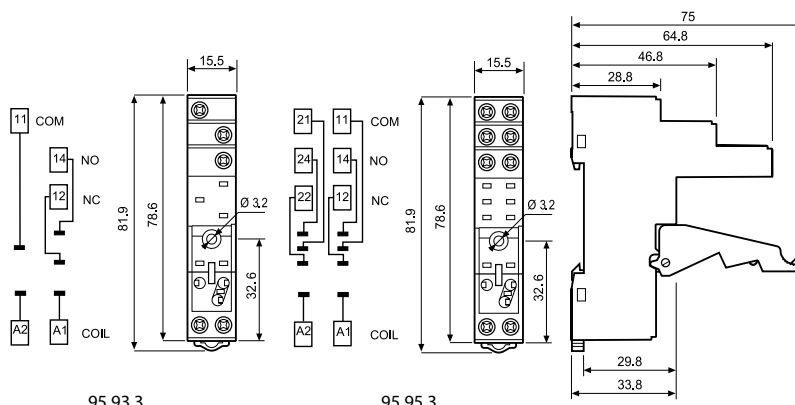
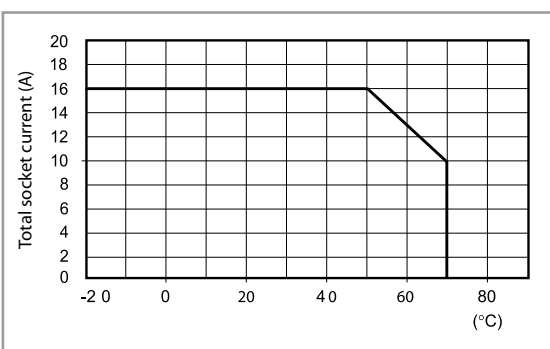

095.08



8-way jumper link for 95.93.3 and 95.95.3 sockets	095.08 (blue)	095.08.0 (black)
Rated values	10 A - 250 V	

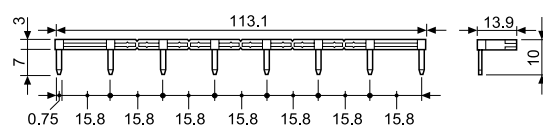

Approvals
(according to type):



* Modules in Black housing are available on request.
Green LED is standard.
Red LED available on request.

99.80 coil indication and EMC suppression modules for 95.93.3 and 95.95.3 sockets		Blue*
Diode (+A1, standard polarity)	(6...220)V DC	99.80.3.000.00
LED	(6...24)V DC/AC	99.80.0.024.59
LED	(28...60)V DC/AC	99.80.0.060.59
LED	(110...240)V DC/AC	99.80.0.230.59
LED + Diode (+A1, standard polarity)	(6...24)V DC	99.80.9.024.99
LED + Diode (+A1, standard polarity)	(28...60)V DC	99.80.9.060.99
LED + Diode (+A1, standard polarity)	(110...220)V DC	99.80.9.220.99
LED + Varistor	(6...24)V DC/AC	99.80.0.024.98
LED + Varistor	(28...60)V DC/AC	99.80.0.060.98
LED + Varistor	(110...240)V DC/AC	99.80.0.230.98
RC circuit	(6...24)V DC/AC	99.80.0.024.09
RC circuit	(28...60)V DC/AC	99.80.0.060.09
RC circuit	(110...240)V DC/AC	99.80.0.230.09
Residual current by-pass	(110...240)V AC	99.80.8.230.07

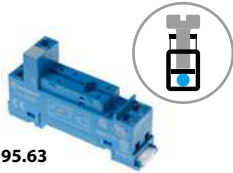

95.63
Approvals
(according to type):



95.65
Approvals
(according to type):



Screw terminal (Box clamp) socket panel or 35 mm rail mount	95.63	95.65
For relay type	40.31	40.51, 40.52, 40.61
Accessories		
Metal retaining clip	095.71	
8-way jumper link	095.08	095.08
Modules (see table below)	99.01	—
Technical data		
Rated values	10 A - 250 V*	
Dielectric strength (between coil and contacts)	6 kV (1.2/50 μs)	2 kV AC
Protection category	IP 20	
Ambient temperature	°C -40...+70 (see diagram L95)	
Screw torque	Nm	0.5
Wire strip length	mm 7	
Max. wire size for 95.63 and 95.65 sockets	solid wire	stranded wire
	mm ²	1 x 6 / 2 x 2.5
	AWG	1 x 10 / 2 x 14

* For currents > 10 A, contact terminals must be connected in parallel (21 with 11, 24 with 14, 22 with 12).
With the relay 40.51 the change-over contact will be 21-12-14.

L 95 - Total socket current v ambient temperature

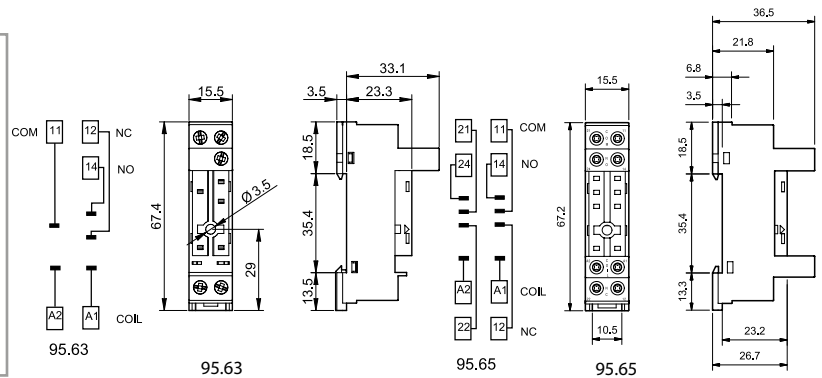
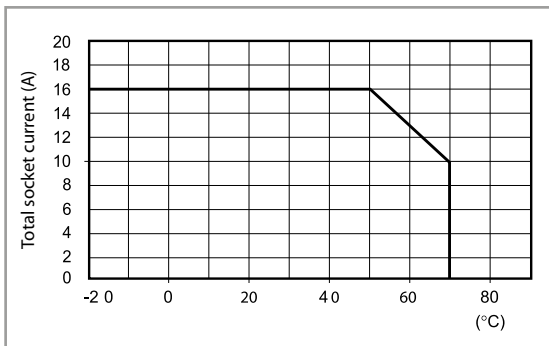

095.08

8-way jumper link for 95.63 and 95.65 sockets	095.08 (blue)
Rated values	10 A - 250 V

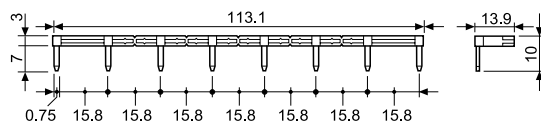

99.01
Approvals
(according to type):



* Modules in Black housing are available on request.

Green LED is standard.
Red LED available on request.

99.01 coil indication and EMC suppression modules for type 95.63 socket

		Blue*
Diode (+A1, standard polarity)	(6...220)V DC	99.01.3.000.00
Diode (+A2, non-standard polarity)	(6...220)V DC	99.01.2.000.00
LED	(6...24)V DC/AC	99.01.0.024.59
LED	(28...60)V DC/AC	99.01.0.060.59
LED	(110...240)V DC/AC	99.01.0.230.59
LED + Diode (+A1, standard polarity)	(6...24)V DC	99.01.9.024.99
LED + Diode (+A1, standard polarity)	(28...60)V DC	99.01.9.060.99
LED + Diode (+A1, standard polarity)	(110...220)V DC	99.01.9.220.99
LED + Diode (+A2, non-standard polarity)	(6...24)V DC	99.01.9.024.79
LED + Diode (+A2, non-standard polarity)	(28...60)V DC	99.01.9.060.79
LED + Diode (+A2, non-standard polarity)	(110...220)V DC	99.01.9.220.79
LED + Varistor	(6...24)V DC/AC	99.01.0.024.98
LED + Varistor	(28...60)V DC/AC	99.01.0.060.98
LED + Varistor	(110...240)V DC/AC	99.01.0.230.98
RC circuit	(6...24)V DC/AC	99.01.0.024.09
RC circuit	(28...60)V DC/AC	99.01.0.060.09
RC circuit	(110...240)V DC/AC	99.01.0.230.09
Residual current by-pass	(110...240)V AC	99.01.8.230.07

A



95.13.2



95.15.2

Approvals
(according to type):



PCB socket	95.13.2 (blue)	95.13.20 (black)	95.15.2 (blue)	95.15.20 (black)
For relay type	40.31		40.51, 40.52, 40.61	
Accessories				
Metal retaining clip (supplied with socket - packaging code SMA)			095.51	
Plastic retaining clip			095.52	
Technical data				
Rated values	12 A - 250 V		10 A - 250 V*	
Dielectric strength	6 kV (1.2/50 μs) between coil and contacts			
Protection category	IP 20			
Ambient temperature	°C -40...+70			

* For currents > 10 A, contact terminals must be connected in parallel (21 with 11, 24 with 14, 22 with 12).
With the relay 40.51 the change-over contact will be 21-12-14.

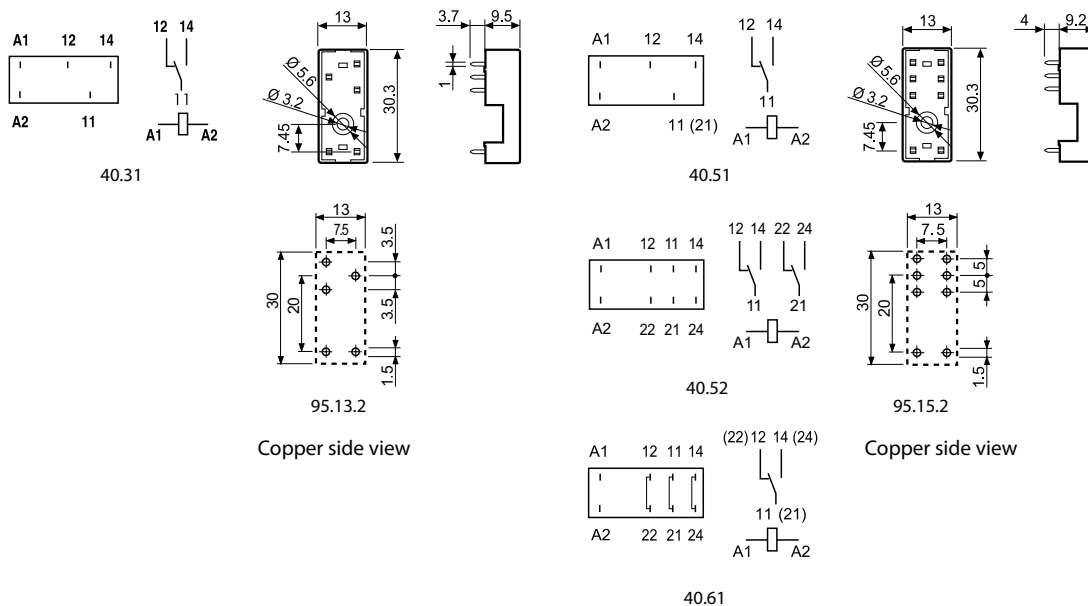

Packaging codes

How to code and identify retaining clip and packaging options for sockets.

Example:

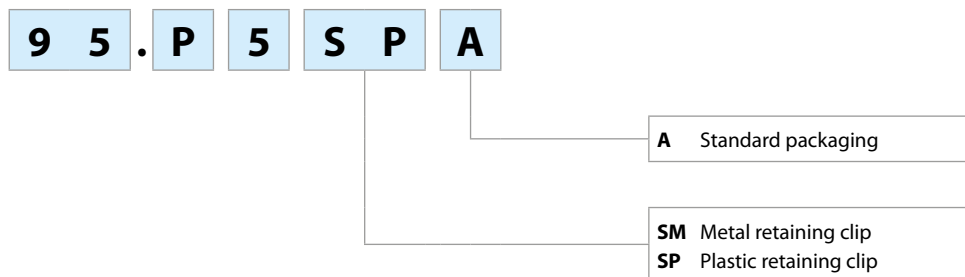



finder[®]
SWITCH TO THE FUTURE

41
SERIES

Low profile PCB relays 3 - 5 - 8 - 12 - 16 A



Medical and
dentistry



Industrial robots



Building
automation



Control
systems



Timers and
lighting
controls



Door and gate
openers

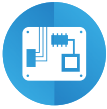

Electronic
circuit boards



Vending
machines

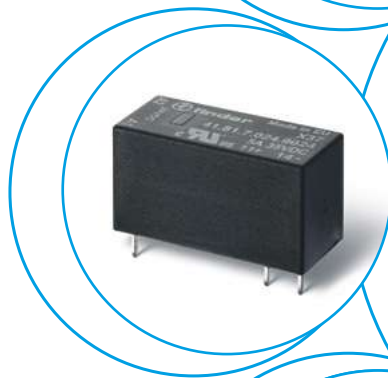

1 & 2 Pole - Low profile (15.7 mm height)
Type 41.31

- 1 Pole 12 A (3.5 mm pin pitch)

Type 41.52

- 2 Pole 8 A (5.0 mm pin pitch)

Type 41.61

- 1 Pole 16 A (5.0 mm pin pitch)

PCB mount

 - **direct or via PCB socket**
35 mm rail mount



 - **via screw and screwless sockets**

- AC and DC coils
- 8 mm, 6 kV (1.2/50 μs) isolation, coil-contacts
- Cadmium Free contact materials
- Flux proof: RT II standard, (RT III option)

FOR UL RATINGS SEE:

"General technical information" page V

For outline drawing see page 9

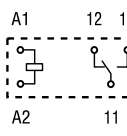
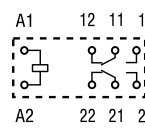
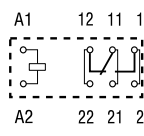
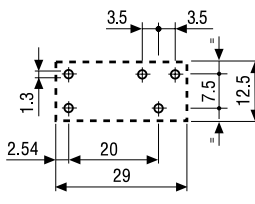
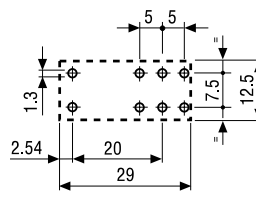
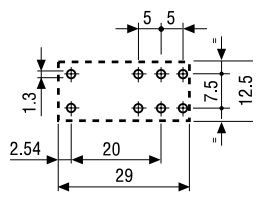
	41.31	41.52	41.61
			
	<ul style="list-style-type: none"> • 3.5 mm contact pin pitch • 1 Pole 12 A • PCB direct or via socket 	<ul style="list-style-type: none"> • 5.0 mm contact pin pitch • 2 Pole 8 A • PCB direct or via socket 	<ul style="list-style-type: none"> • 5.0 mm contact pin pitch • 1 Pole 16 A • PCB direct or via socket
			
			
	Copper side view	Copper side view	Copper side view
Contact specification			
Contact configuration	1 CO (SPDT)	2 CO (DPDT)	1 CO (SPDT)
Rated current/Maximum peak current	A 12/25	8/15	16/30
Rated voltage/Maximum switching voltage	V AC 250/400	250/400	250/400
Rated load AC1	VA 3000	2000	4000
Rated load AC15 (230 V AC)	VA 600	400	750
Single phase motor rating (230 V AC)	kW 0.5	0.3	0.5
Breaking capacity DC1: 30/110/220 V	A 12/0.3/0.12	8/0.3/0.12	16/0.3/0.12
Minimum switching load	mW (V/mA) 300 (5/5)	300 (5/5)	300 (5/5)
Standard contact material	AgNi	AgNi	AgNi
Coil specification			
Nominal voltage (U _N)	V AC (50/60 Hz) 24 - 230	24 - 230	24 - 230
	V DC 5 - 6 - 12 - 24 - 48 - 60 - 110	5 - 6 - 12 - 24 - 48 - 60 - 110	5 - 6 - 12 - 24 - 48 - 60 - 110
Rated power AC/DC	VA (50 Hz)/W 0.75/0.4	0.75/0.4	0.75/0.4
Operating range	AC (0.8...1.1)U _N	(0.8...1.1)U _N	(0.8...1.1)U _N
	DC (0.7...1.5)U _N	(0.7...1.5)U _N	(0.7...1.5)U _N
Holding voltage	AC/DC 0.8/0.4 U _N	0.8/0.4 U _N	0.8/0.4 U _N
Must drop-out voltage	AC/DC 0.15/0.1 U _N	0.15/0.1 U _N	0.15/0.1 U _N
Technical data			
Mechanical life AC/DC	cycles 10 · 10 ⁶ / 10 · 10 ⁶	10 · 10 ⁶ / 10 · 10 ⁶	10 · 10 ⁶ / 10 · 10 ⁶
Electrical life at rated load AC1	cycles 60 · 10 ³	60 · 10 ³	50 · 10 ³
Operate/release time	ms 8/6	8/6	8/6
Insulation between coil and contacts (1.2/50 μs)	kV 6 (8 mm)	6 (8 mm)	6 (8 mm)
Dielectric strength between open contacts	V AC 1000	1000	1000
Ambient temperature range AC/DC	°C -40...+70/-40...+85	-40...+70/-40...+85	-40...+70/-40...+85
Environmental protection	RT II	RT II	RT II
Approvals (according to type)			

**1 & 2 Pole - Polarized bistable, Low profile
(15.7 mm height)**
Type 41.52

- 2 Pole 8 A (5.0 mm pin pitch)

Type 41.61

- 1 Pole 16 A (5.0 mm pin pitch)

Printed Circuit mount

- Polarized bistable relay with 2 coils
- 10 mm, 6 kV (1.2/50 μ s) isolation, coil-contacts
- Cadmium Free contact materials
- Flux proof: RT II standard

41.52.6.xxx

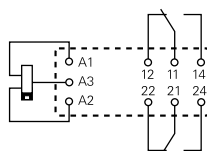
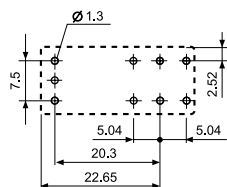

- 2 Pole, 8 A
- PCB direct mount

 2 coil version:
 A3(+) A2 (-) = Set
 A3(+) A1 (-) = Reset

Copper side view

41.61.6.xxx

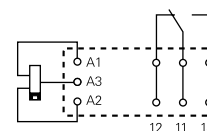
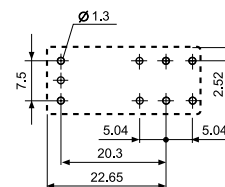
- 1 Pole, 16 A
- PCB direct mount

 2 coil version:
 A3(+) A2 (-) = Set
 A3(+) A1 (-) = Reset

Copper side view

For outline drawing see page 9

Contact specification

Contact configuration		2 CO (DPDT)	1 CO (SPDT)
Rated current/ Maximum peak current (I_N/I_{max})	A	8/15	16/30
Rated voltage/ Maximum switching voltage (U_N/U_{max})	V AC	250/400	250/400
Rated load AC1	VA	2000	4000
Rated load AC15 (230 V AC)	VA	350	750
Single phase motor rating (230 V AC)	kW	0.37	0.55
Breaking capacity DC1: 30/110/220 V	A	8/0.3/0.12	16/0.3/0.12
Minimum switching load	mW (V/mA)	500 (5/100)	500 (5/100)
Standard contact material		AgSnO ₂	AgSnO ₂

Coil specification

Nominal voltage (U_N)	V DC	5 - 12 - 24	5 - 12 - 24
Rated power (P_N)	W	0.65	0.65
Operating range	DC	(0.7...1.1) U_N	(0.7...1.1) U_N
Min. impulse duration	ms	20	20
Max. impulse duration	s	30	30

Technical data

Mechanical life DC	cycles	$5 \cdot 10^6$	$5 \cdot 10^6$
Electrical life at rated load AC1	cycles	$30 \cdot 10^3$	$30 \cdot 10^3$
Operate/release time	ms	10/5	10/10
Insulation between coil and contacts (1.2/50 μ s)	kV	6 (10 mm)	6 (10 mm)
Dielectric strength between open contacts	V AC	1000	1000
Ambient temperature range	°C	-40...+85	-40...+85
Environmental protection		RT II	RT II

Approvals (according to type)

Solid State Relays
Printed circuit mount:
 - direct or via PCB socket
35 mm rail mount:
 - via screw or screwless sockets

- Single circuit output switching options
 - 5 A 24 V DC
 - 3 A 240 V AC
- Silent, high speed switching with long electrical life
- LED indicator
- Low profile (15.7 mm)
- Wash tight: RT III
- 2500 V AC insulation, input-output

41.81 - 9024



- 5 A, 24 V DC output switching
- PCB or 93 Series sockets

41.81 - 8240



- 3 A, 240 V AC output switching
- Zero crossing switching
- PCB or 93 Series sockets

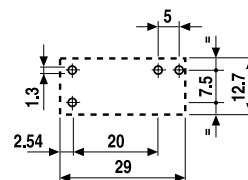
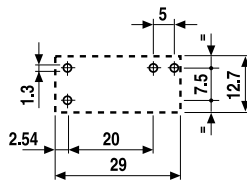
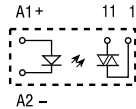
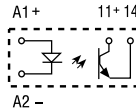

Copper side view

Copper side view

For outline drawing see page 9

Output circuit

Contact configuration		1 NO (SPST-NO)		1 NO (SPST-NO)	
Rated current/ Maximum peak current (10 ms)	A	5/40		3/40	
Rated voltage/ Maximum blocking voltage	V	(24/35)DC		(240/—)AC	
Switching voltage range	V	(1.5...24)DC		(12...275)AC	
Repetitive peak off-state voltage	V _{pk}	—		600	
Minimum switching current	mA	1		50	
Max. "OFF-state" leakage current	mA	0.01		1	
Max. "ON-state" voltage drop	V	0.3		1.1	

Input circuit

Nominal voltage	V DC	12	24	12	24
Operating range	V DC	8...17	14...32	8...17	14...32
Control current	mA	5.5	9	8.8	9
Release voltage	V DC	4	9	4	9
Impedance	Ω	1550	2600	1030	2600

Technical data

Operate/release time	ms	0.05/0.25		10/10	
Dielectric strength between input/output	V AC	2500		2500	
Ambient temperature range	°C	-20...+60		-20...+60	
Environmental protection		RT III		RT III	

Approvals (according to type)



Ordering information

Electromechanical relay (EMR)

Example: 41 series low-profile PCB relay, 2 CO (DPDT), 24 V DC coil.

A

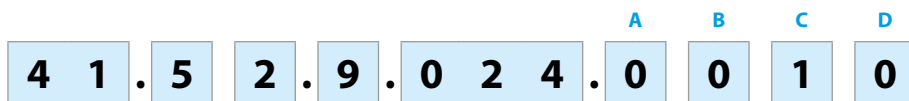

- Series** —————
- Type** —————
3 = PCB - 3.5 mm pinning
5 = PCB - 5.0 mm pinning
6 = PCB - 5.0 mm pinning
- No. of poles** —————
1 = 1 pole for
 41.31, 12 A
 41.61, 16 A
2 = 2 pole for
 41.52, 8 A
- Coil version** —————
6 = DC bistable, 2 coils
8 = AC
9 = DC
- Coil voltage** —————
See coil specifications

A: Contact material

- 0 = Standard AgNi
- 4 = AgSnO₂
- 5 = AgNi + Au

B: Contact circuit

- 0 = CO (nPDT)
- 3 = NO (nPST)

D: Special versions

- 0 = Flux proof (RT II)
- 1 = Wash tight (RT III)
- 6 = Bistable version (RT II)

C: Options

- 0 = Production line 0
- 1 = Production line 1

Selecting features and options: only combinations in the same row are possible.

Preferred selections for best availability are shown in **bold**.

Type	Coil version	A	B	C	D
41.31	DC	0 - 4 - 5	0 - 3	1	0 - 1
41.52	DC	0 - 5	0 - 3	1	0 - 1
41.61	DC	0 - 4	0 - 3	1	0 - 1
41.31/52/61	AC	0	0	0	0
41.52	DC bistable	4	0	1	6
41.61	DC bistable	4	0 - 3	1	6

Solid state relay (SSR)

Example: 41 series SSR relay, 5 A output, 24 V DC supply.

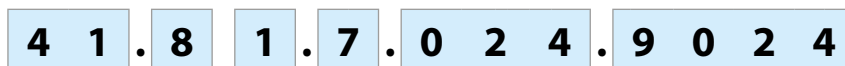

- Series** —————
- Type** —————
8 = SSR type
- Output** —————
1 = 1 NO (SPST-NO)
- Input circuit** —————
See coil specifications

Output circuit

- 9024 = 5 A - 24 V DC
- 8240 = 3 A - 240 V AC

Electromechanical relay

A

Technical data

Insulation according to EN 61810-1							
		1 pole		1 pole bistable	2 pole		2 pole bistable
Nominal voltage of supply system	V AC	230/400		230/400	230/400		230/400
Rated insulation voltage	V AC	250	400	250	250	400	250
Pollution degree		3	2	2	3	2	2
Insulation between coil and contact set							
Type of insulation		Reinforced (8 mm)		Reinforced (10 mm)	Reinforced (8 mm)		Reinforced (10 mm)
Overvoltage category		III		III	III		III
Rated impulse voltage	kV (1.2/50 µs)	6		6	6		6
Dielectric strength	V AC	4000		4000	4000		4000
Insulation between adjacent contacts							
Type of insulation		—		—	Basic		Basic
Overvoltage category		—		—	III		III
Rated impulse voltage	kV (1.2/50 µs)	—		—	4		4
Dielectric strength	V AC	—		—	2000		2000
Insulation between open contacts							
Type of disconnection		Micro-disconnection			Micro-disconnection		
Dielectric strength	V AC/kV (1.2/50 µs)	1000/1.5			1000/1.5		
Insulation between coil terminals							
Rated impulse voltage (surge) differential mode (according to EN 61000-4-5)	kV(1.2/50 µs)	2					
Other data							
Bounce time: NO/NC	ms	4/6 (monostable) - 2/10 (bistable)					
Vibration resistance (5...55)Hz: NO/NC	g	15/2 (monostable) - 5/3 (bistable)					
Shock resistance	g	16 (monostable) - 10 (bistable)					
Power lost to the environment	without contact current	W	0.4 (monostable)				
	with rated current	W	1.7 (41.31)	1.2 (41.52)	1.8 (41.61)		
Recommended distance between relays mounted on PCB	mm	≥ 5					

Contact specification

F 41 - Electrical life (AC) v contact current (monostable)

Types 41.31/61

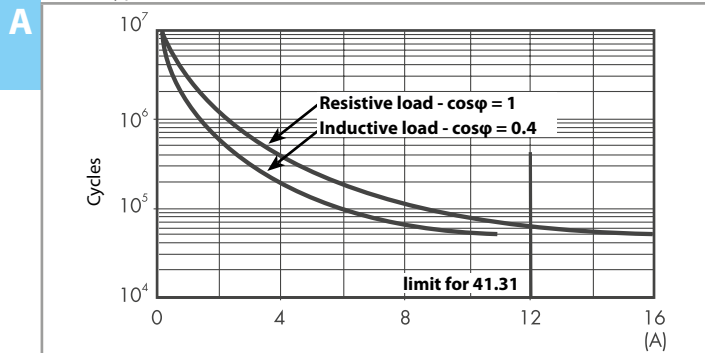

F 41 - Electrical life (AC) v contact current (monostable)

Type 41.52

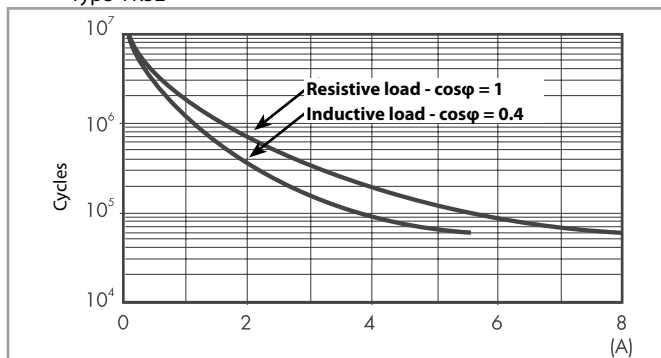

F 41 - Electrical life (AC) v contact current (bistable)

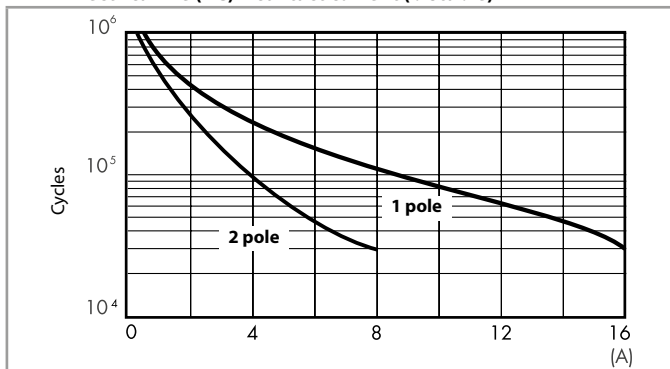

H 41 - Maximum DC1 breaking capacity

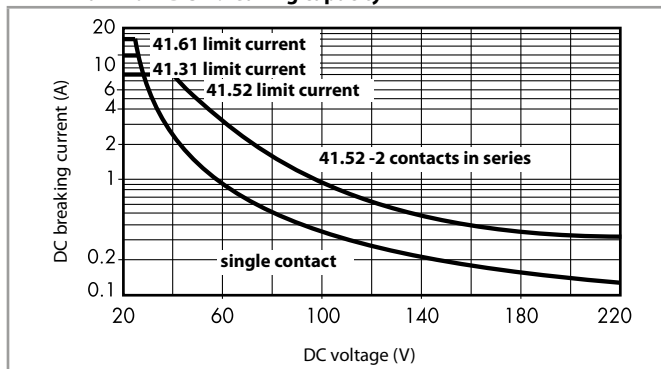

- When switching a resistive load (DC1) having voltage and current values under the curve, an electrical life of $\geq 100 \cdot 10^3$ can be expected.
- In the case of DC13 loads, the connection of a diode in parallel with the load will permit a similar electrical life as for a DC1 load. Note: the release time for the load will be increased.

Coil specifications

AC coil data

Nominal voltage	Coil code	Operating range		Resistance	Rated coil consumption
		U_{min}	U_{max}		
U_N		V	V	R	I at U_N
V		V	V	Ω	mA
24	8.024	19.2	26.4	350	31.6
230	8.230	184	253	32500	3.2

DC coil data

Nominal voltage	Coil code	Operating range		Resistance	Rated coil consumption
		U_{min}	U_{max}		
U_N		V	V	R	I at U_N
V		V	V	Ω	mA
5	9.005	3.5	7.5	62	80
6	9.006	4.2	9	90	66.7
12	9.012	8.4	18	360	33.3
24	9.024	16.8	36	1440	16.7
48	9.048	33.6	72	5760	8.3
60	9.060	42	90	9000	6.6
110	9.110	77	165	24200	4.5

DC coil data (bistable)

Nominal voltage	Coil code	Operating range			Resistance	Rated coil power
		Set	Reset	Set/Reset		
U_N		U_{min}	U_{min}	U_{max}	R	I at U_N
V		V	V	V	Ω	mW
5	6.005	3.5	3.5	5.5	38	650
12	6.012	8.4	8.4	13.2	220	650
24	6.024	16.8	16.8	26.4	885	650

R 41 - AC coil operating range v ambient temperature

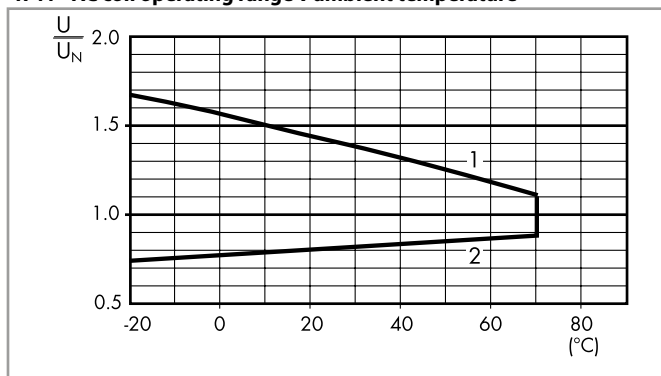

- 1 - Max. permitted coil voltage.
- 2 - Min. pick-up voltage with coil at ambient temperature.

R 41 - DC coil operating range v ambient temperature

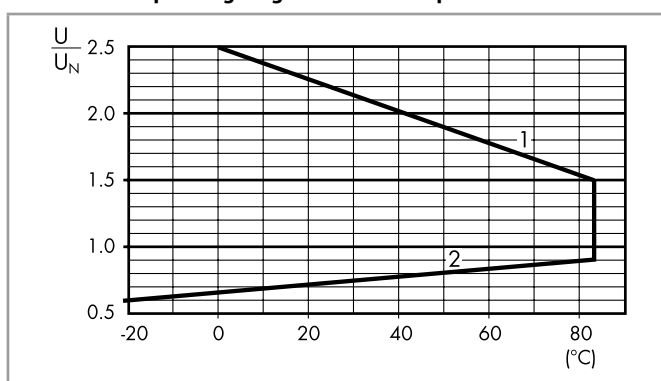

- 1 - Max. permitted coil voltage.
- 2 - Min. pick-up voltage with coil at ambient temperature.

Solid state relay

Technical data

Other data		41.81 - 9024	41.81 - 8240
Power lost to the environment	without current	W 0.25	0.25
	with maximum current	W 1.75	3.5

Input specification

Input data - DC types

Nominal voltage U_N	Input code	Operating range		Release voltage	Impedance	Control current I at U_N
		U_{min}	U_{max}			
V		V	V	V	Ω	mA
12	7.012	8	17	4	1550	5.5
24	7.024	14	32	9	2600	9

Output specification

L 41 - Output current v ambient temperature

SSR - 5 A DC output types

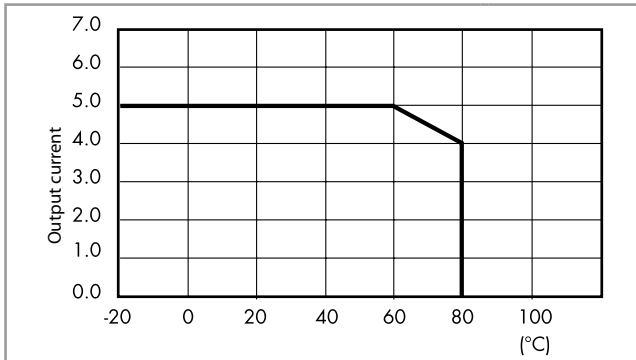

L 41 - Output current v ambient temperature

SSR - 3 A AC output types

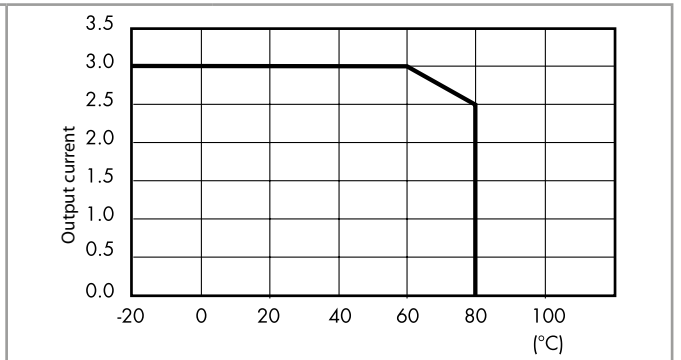

Outline drawings

Type 41.31/52/61

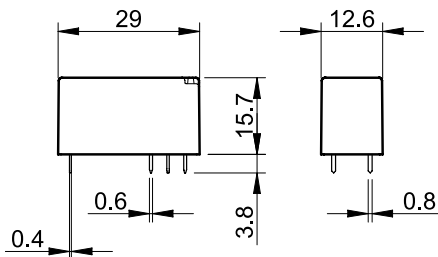

Type 41.52.6.xxx/41.61.6.xxx

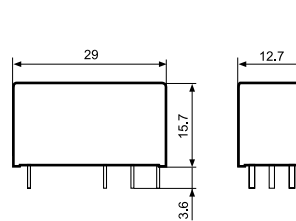

Type 41.81-9024/41.81-8240

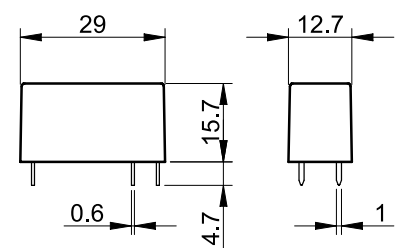

A



93.02

Approvals
(according to type):

Screw terminal socket 35 mm (EN 60715) mounting

Supply voltage	Relay type	Socket type	
6 V AC/DC	41.52.9.005.0010 or 41.61.9.005.0010	93.02.0.024	
12 V AC/DC	41.52.9.012.0010 or 41.61.9.012.0010	93.02.0.024	
24 V AC/DC	41.52/61.9.024.0010 or 41.81.7.024.xxxx	93.02.0.024	
60 V AC/DC	41.52.9.060.0010 or 41.61.9.060.0010	93.02.0.060	
(110...125)V AC/DC	41.52.9.110.0010 or 41.61.9.110.0010	93.02.0.125	
(220...240)V AC/DC	41.52.9.110.0010 or 41.61.9.110.0010	93.02.0.240	
(230...240)V AC	41.52.9.110.0010 or 41.61.9.110.0010	93.02.8.230	
6 V DC	41.52.9.005.0010 or 41.61.9.005.0010	93.02.7.024	
12 V DC	41.52/61.9.012.0010 or 41.81.7.012.xxxx	93.02.7.024	
24 V DC	41.52/61.9.024.0010 or 41.81.7.024.xxxx	93.02.7.024	
48 V DC	41.52.9.048.0010 or 41.61.9.048.0010	93.02.7.060	
60 V DC	41.52.9.060.0010 or 41.61.9.060.0010	93.02.7.060	
Accessories			
8-way jumper link	093.08 (see specification next page)		
Plastic separator	093.01 (see specification next page)		
Sheet of marker tags, 48 tags	060.48 (see specification next page)		
Technical data			
Rated values	10 A - 250 V		
Dielectric strength	6 kV (1.2/50 μ s) between coil and contacts		
Protection category	IP 20		
Ambient temperature ($U_N \leq 60$ V / > 60 V)	°C -40...+70/-40...+55		
 Screw torque	Nm	0.5	
Wire strip length	mm	8	
Max. wire size for 93.02 socket	solid wire	stranded wire	
	mm ²	1 x 6 / 2 x 2.5	1 x 4 / 2 x 2.5
	AWG	1 x 10 / 2 x 14	1 x 12 / 2 x 14

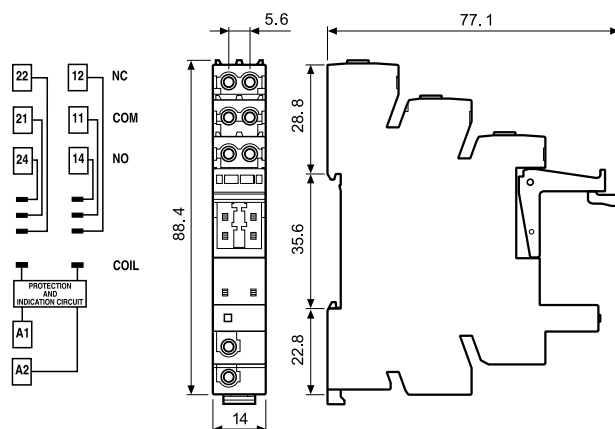

Note: Not for bistable relays

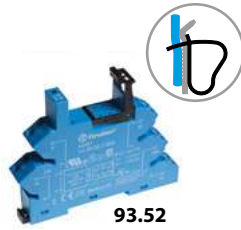

93.52

Approvals
(according to type):

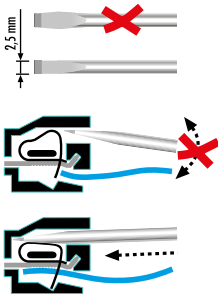

Screw terminal socket 35 mm (EN 60715) mounting

Supply voltage	Relay type	Socket type	
6 V AC/DC	41.52.9.005.0010 or 41.61.9.005.0010	93.52.0.024	
12 V AC/DC	41.52.9.012.0010 or 41.61.9.012.0010	93.52.0.024	
24 V AC/DC	41.52/61.9.024.0010 or 41.81.7.024.xxxx	93.52.0.024	
60 V AC/DC	41.52.9.060.0010 or 41.61.9.060.0010	93.52.0.060	
(110...125)V AC/DC	41.52.9.110.0010 or 41.61.9.110.0010	93.52.0.125	
(220...240)V AC/DC	41.52.9.110.0010 or 41.61.9.110.0010	93.52.0.240	
(230...240)V AC	41.52.9.110.0010 or 41.61.9.110.0010	93.52.8.230	
6 V DC	41.52.9.005.0010 or 41.61.9.005.0010	93.52.7.024	
12 V DC	41.52/61.9.012.0010 or 41.81.7.012.xxxx	93.52.7.024	
24 V DC	41.52/61.9.024.0010 or 41.81.7.024.xxxx	93.52.7.024	
48 V DC	41.52.9.048.0010 or 41.61.9.048.0010	93.52.7.060	
60 V DC	41.52.9.060.0010 or 41.61.9.060.0010	93.52.7.060	
Accessories			
8-way jumper link	093.08 (see table below)		
Plastic separator	093.01 (see table below)		
Sheet of marker tags, 48 tags	060.48 (see table below)		
Technical data			
Rated values	10 A - 250 V		
Dielectric strength	6 kV (1.2/50 μs) between coil and contacts		
Protection category	IP 20		
Ambient temperature (U _N ≤ 60 V / > 60 V)	°C	-40...+70/-40...+55	
Wire strip length	mm	8	
Max. wire size for 93.52 socket	solid wire	stranded wire	
	mm ²	1 x 2.5	1 x 2.5
	AWG	1 x 14	1 x 14

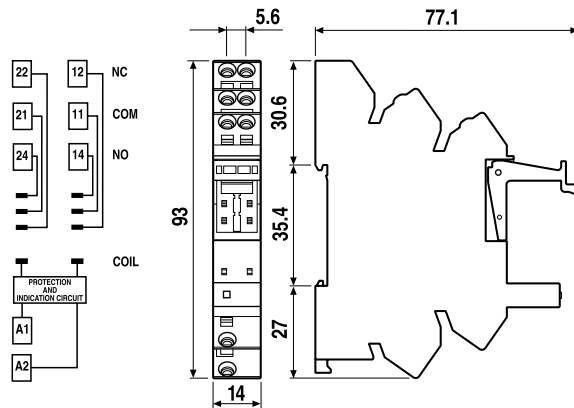

Note: Not for bistable relays

Accessories



093.08

Approvals
(according to type):



8-way jumper link for 93.02 and 93.52 sockets	093.08 (blue)	093.08.0 (black)	093.08.1 (red)
Rated values	10 A - 250 V		

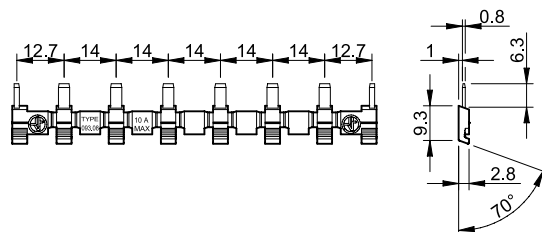

Plastic separator for 93.02 and 93.52 sockets	093.01
---	--------

Thickness 2 mm, required at the start and the end of a group of interfaces.

Can be used for visual separation group, must be used for:

- protective separation of different voltages of neighbouring PLC interfaces according to VDE 0106-101
- protection of cut jumper links



093.01

Sheet of marker tags (CEMBRE Thermal transfer printers), plastic, 48 tags, 6 x 12 mm	060.48
--	--------

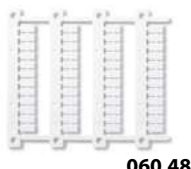

060.48

A



95.13.2



95.15.2

Approvals
(according to type):



PCB socket	95.13.2 (blue)	95.13.20 (black)	95.15.2 (blue)	95.15.20 (black)
For relay type	41.31		41.52, 41.61, 41.81**	
Accessories				
Plastic retaining clip	095.42.30			
Technical data				
Rated values	10 A - 250 V*			
Dielectric strength	6 kV (1.2/50 μs) between coil and contacts			
Protection category	IP 20			
Ambient temperature	°C -40...+70			

* For currents > 10 A, contact terminals must be connected in parallel (21 with 11, 24 with 14, 22 with 12).

(1) With the relay 41.81 the NO change-over contact will be 11-14.

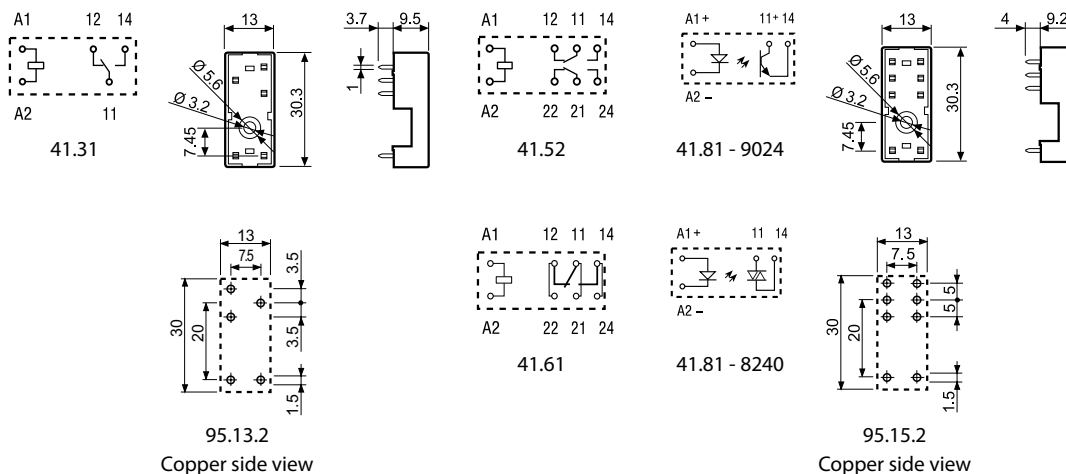

Note: Not for bistable relays

Packaging codes

How to code and identify retaining clip and packaging options for sockets.

Example:

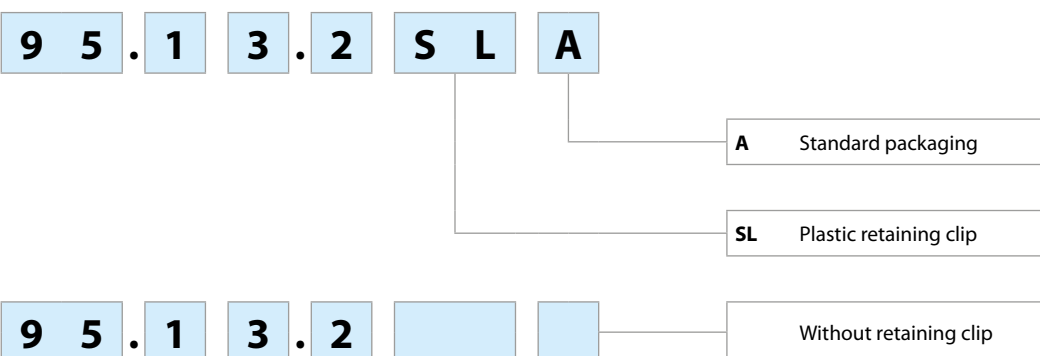



Low profile PCB relays 10 - 16 A



Medical and dentistry



Alarm systems



Air conditioners



Burners, boilers and furnaces



Electric and electronic toys and games



Door and gate openers

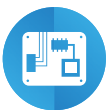

Electronic circuit boards



Vending machines

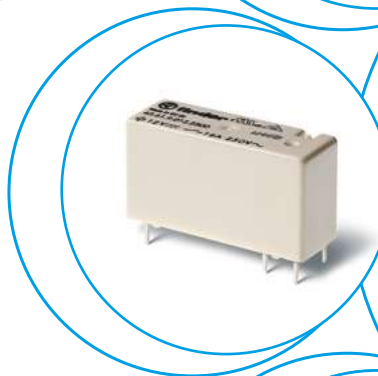

1 Pole - Low profile (15.4 mm height)
Type 43.41
 - 1 Pole, 10 A (3.2 mm pin pitch)
Type 43.41-0300
 - 1 Pole NO, 10 A (5 mm pin pitch)
Type 43.61-0300
 - 1 Pole NO, 16 A (5 mm pin pitch)
PCB mount - direct or via PCB socket (43.41 version)

- Sensitive DC coil:
 - 250 mW (10 A version)
 - 400 mW (16 A version)
- Very high coil-contact isolation 10 mm, 6 kV (1.2/50 μs)
- Cadmium Free contacts (preferred version)
- Flux proof: RT II standard, (RT III option)



- 3.2 mm contact pin pitch
- 1 Pole CO, 10 A
- PCB direct or via socket

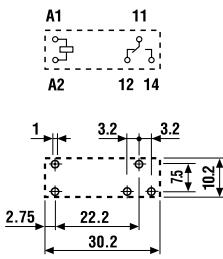

Copper side view



- 5.0 mm contact pin pitch
- 1 Pole NO, 10 A
- PCB mount

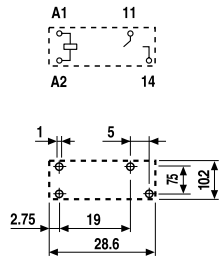

Copper side view



- 5.0 mm contact pin pitch
- 1 Pole NO, 16 A
- PCB mount

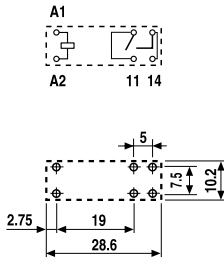

Copper side view

FOR UL RATINGS SEE:
 "General technical information" page V

For outline drawing see page 5

Contact specification

Contact configuration		1 CO (SPDT)	1 NO (SPST-NO)	1 NO (SPST-NO)
Rated current/Maximum peak current	A	10/15	10/15	16/25
Rated voltage/Maximum switching voltage	V AC	250/400	250/400	250/400
Rated load AC1	VA	2500	2500	4000
Rated load AC15 (230 V AC)	VA	500	500	750
Single phase motor rating (230 V AC)	kW	—	—	—
Breaking capacity DC1: 30/110/220 V	A	10/0.3/0.12	10/0.3/0.12	16/0.3/0.12
Minimum switching load	mW (V/mA)	300 (5/5)	300 (5/5)	300 (5/5)
Standard contact material		AgNi	AgNi	AgNi

Coil specification

Nominal voltage (U _N)	V AC (50/60 Hz)	—	—	—
	V DC	3 - 6 - 9 - 12 - 18 - 24 - 36 - 48	3 - 6 - 9 - 12 - 18 - 24 - 36 - 48	12 - 24 - 48
Rated power AC/DC	VA (50 Hz)/W	—/0.25	—/0.25	—/0.4
Operating range	AC	—	—	—
	DC	(0.7...1.5)U _N	(0.7...1.5)U _N	(0.7...1.2)U _N
Holding voltage	AC/DC	—/0.4 U _N	—/0.4 U _N	—/0.4 U _N
Must drop-out voltage	AC/DC	—/0.05 U _N	—/0.05 U _N	—/0.05 U _N

Technical data

Mechanical life AC/DC	cycles	—/10 · 10 ⁶	—/10 · 10 ⁶	—/10 · 10 ⁶
Electrical life at rated load AC1	cycles	100 · 10 ³	100 · 10 ³	50 · 10 ³
Operate/release time	ms	6/4	6/2	6/2
Insulation between coil and contacts (1.2/50 μs)	kV	6 (10 mm)	6 (10 mm)	6 (10 mm)
Dielectric strength between open contacts	V AC	1000	1000	1000
Ambient temperature range	°C	−40...+85	−40...+85	−40...+85
Environmental protection		RT II	RT II	RT II

Approvals (according to type)



Ordering information

Example: 43 series low-profile PCB relay, 1 CO (SPDT), 24 V DC coil.

A

4 3 . 4 1 . 7 . 0 2 4 . 2 0 0 . 0

Series

Type

4 = PCB - 3.2 mm pinning
(CO/SPDT, 10 A)
PCB - 5 mm pinning
(NO/SPST-NO, 10 A)
6 = PCB - 5 mm pinning
(NO/SPST-NO, 16 A)

No. of poles

1 = 1 pole

Coil version

7 = Sensitive DC (only for 43.41)
9 = DC (only for 43.61)

Coil voltage

See coil specifications

A: Contact material

0 = AgNi
2 = AgCdO
4 = AgSnO₂
5 = AgNi + Au

B: Contact circuit

0 = CO (SPDT) - (for 43.41 only)
3 = NO (SPST)

D: Special versions

0 = Flux proof (RT II)
1 = Wash tight (RT III)

C: Options

0 = None

Selecting features and options: only combinations in the same row are possible.

Preferred selections for best availability are shown in **bold**.

Type	Coil version	A	B	C	D
43.41	sensitive DC	0 - 2 - 4 - 5	0 - 3	0	0 - 1
43.61	DC	0 - 2 - 4	3	0	0

Technical data

Insulation according to EN 61810-1

Nominal voltage of supply system	V AC	230/400
Rated insulation voltage	V AC	250 400
Pollution degree		3 2

Insulation between coil and contact set

Type of insulation		Reinforced (10 mm)
Overvoltage category		III
Rated impulse voltage	kV (1.2/50 µs)	6
Dielectric strength	V AC	4000

Insulation between open contacts

Type of disconnection		Micro-disconnection
Dielectric strength	V AC/kV (1.2/50 µs)	1000/1.5

Insulation between coil terminals

Rated impulse voltage (surge) differential mode (according to EN 61000-4-5)	kV(1.2/50 µs)	2
--	---------------	---

Other data

Bounce time: NO/NC	ms	3/6
Vibration resistance (5...55)Hz: NO/NC	g	15/3
Shock resistance	g	15
Power lost to the environment	without contact current	W 0.25 (43.41) 0.4 (43.61)
	with rated current	W 1.3 (43.41) 2 (43.61)
Recommended distance between relays mounted on PCB	mm	≥ 5

Contact specification

F 43 - Electrical life (AC) v contact current

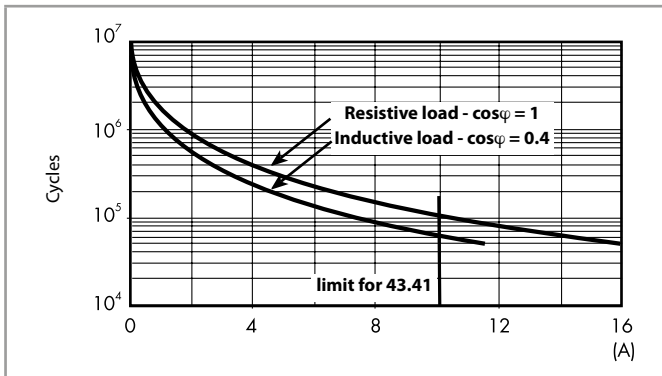

H 43 - Maximum DC1 breaking capacity

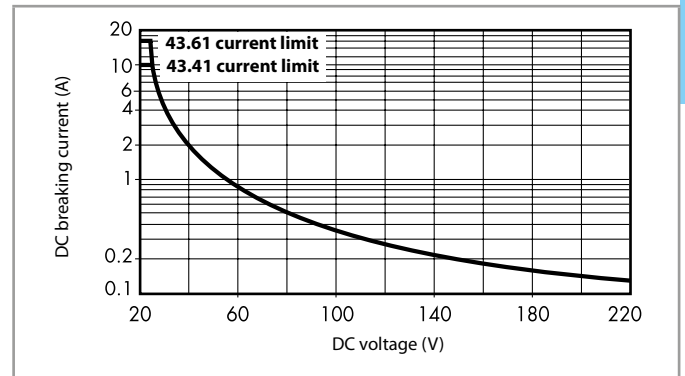

- When switching a resistive load (DC1) having voltage and current values under the curve, an electrical life of $\geq 100 \cdot 10^3$ for 43.41 and $\geq 50 \cdot 10^3$ for 43.61 can be expected.
- In the case of DC13 loads, the connection of a diode in parallel with the load will permit a similar electrical life as for a DC1 load.
Note: the release time for the load will be increased.

Coil specifications

DC coil data - 0.25 W sensitive (type 43.41)

Nominal voltage U_N V	Coil code	Operating range		Resistance R Ω	Rated coil consumption I at U_N mA
		U_{min} V	U_{max} V		
3	7.003	2.2	4.5	36	83.5
6	7.006	4.2	9	150	40
9	7.009	6.5	13.5	324	27.7
12	7.012	8.4	18	580	20.7
18	7.018	13	27	1300	13.8
24	7.024	16.8	36	2200	10.9
36	7.036	25.2	54	5200	6.9
48	7.048	33.6	72	9200	5.2

R 43 - DC coil operating range v ambient temperature

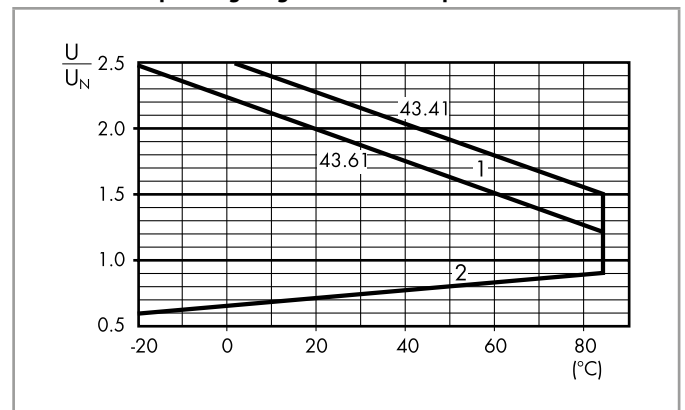

- 1 - Max. permitted coil voltage.
- 2 - Min. pick-up voltage with coil at ambient temperature.

DC coil data - 0.4 W standard (type 43.61)

Nominal voltage U_N V	Coil code	Operating range		Resistance R Ω	Rated coil consumption I at U_N mA
		U_{min} V	U_{max} V		
12	9.012	8.4	14.4	360	33.3
24	9.024	16.8	28.8	1400	17.1
48	9.048	33.6	57.6	5760	8.3

Outline drawings

Type 43.41

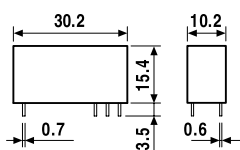

Type 43.41-0300/43.61-0300

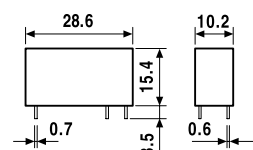



A 95.23
Approvals
(according to type):



PCB socket (for changeover contacts only)	95.23 (blue)	95.23.0 (black)
For relay type	43.41	43.41
Accessories		
Metal retaining clip (supplied with socket - packaging code SMA)		095.43
Technical data		
Rated values	10 A - 250 V	
Insulation	6 kV (1.2/50 μs) between coil and contacts	
Protection category	IP 20	
Ambient temperature	°C -40...+70	

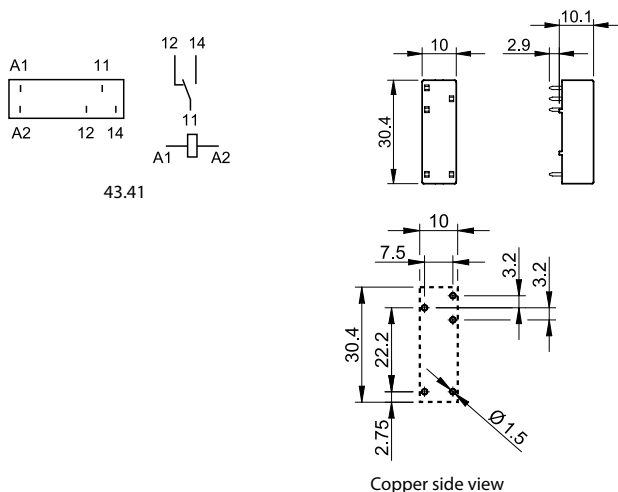

Packaging codes

How to code and identify retaining clip and packaging options for sockets.

Example:

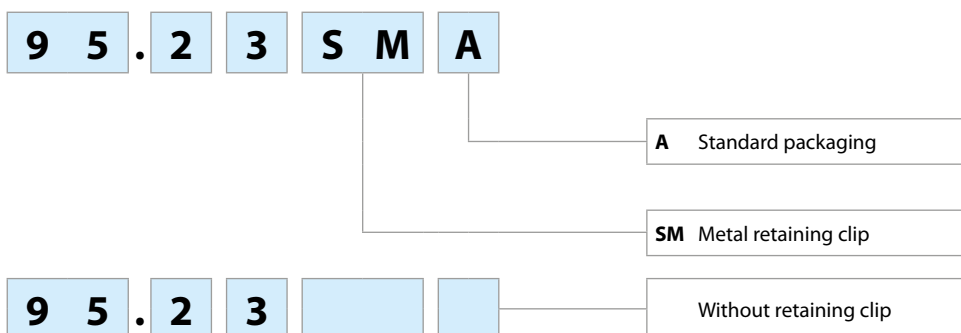



finder[®]
SWITCH TO THE FUTURE

44
SERIES

Miniature P.C.B. Relays 6 - 10 A



Jacuzzis and hot tubs



Control panels



Traffic light controls



Control and management of electric power



Industrial refrigerators



Door and gate openers

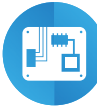

Electronic circuit boards



Panels for electrical distribution



2 CO power relays with high separation between adjacent contacts
Direct PCB or socket mount

Type 44.52

- 2 CO 6 A (5 mm pin pitch)

Type 44.62

- 2 CO 10 A (5 mm pin pitch)

- DC coils (Standard or sensitive)
- Cadmium Free contact materials
- 8 mm, 6 kV (1.2/50 μs) isolation, coil-contacts
- UL Listing (certain relay/socket combinations)
- 95 series sockets for PCB or 35 mm rail mounting (EN 60715) with Screw, Screwless or Push-in terminals
- Coil Indication and EMC suppression modules 99 series and Timer module 86.30 options
- Environmental protection: RT II - flux proof (Standard)

FOR UL RATINGS SEE:

"General technical information" page V

For outline drawing see 5

Contact specification

Contact configuration		2 CO (DPDT)	2 CO (DPDT)
Rated current/Maximum peak current	A	6/10	10/20
Rated voltage/Maximum switching voltage	V AC	250/400	250/400
Rated load AC1	VA	1500	2500
Rated load AC15 (230 V AC)	VA	250	500
Single phase motor rating (230 V AC)	kW	0.185	0.37
Breaking capacity DC1: 30/110/220 V	A	6/0.3/0.13	10/0.3/0.13
Minimum switching load	mW (V/mA)	300 (5/5)	300 (5/5)
Standard contact material		AgNi	AgNi

Coil specification

Nominal voltage (U _N)	V AC (50/60 Hz)	—	—
	V DC	6 - 9 - 12 - 14 - 24 - 28 - 48 - 60 - 110 - 125	
Rated power AC/DC/sens. DC	VA (50 Hz)/W/W	—/0.65/0.5	—/0.65/0.5
Operating range	AC	—	—
	DC/sens. DC	(0.73...1.5)U _N / (0.73...1.7)U _N	(0.73...1.5)U _N / (0.8...1.7)U _N
Holding voltage	AC/DC	—/0.4 U _N	—/0.4 U _N
Must drop-out voltage	AC/DC	—/0.1 U _N	—/0.1 U _N

Technical data

Mechanical life AC/DC	cycles	—/20 · 10 ⁶	—/20 · 10 ⁶
Electrical life at rated load AC1	cycles	150 · 10 ³	100 · 10 ³
Operate/release time	ms	8/5 - (12/5 sensitive)	8/5 - (12/5 sensitive)
Insulation between coil and contacts (1.2/50 μs)	kV	6 (8 mm)	6 (8 mm)
Dielectric strength between open contacts	V AC	1000	1000
Ambient temperature range	°C	-40...+85	-40...+85
Environmental protection		RT II	RT II

Approvals (according to type)



- 2 CO 6 A
- PCB or 95 series sockets

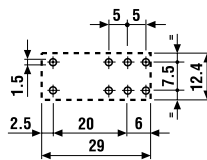
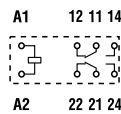

Copper side view



- 2 CO 10 A
- PCB or 95 series sockets

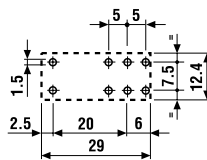
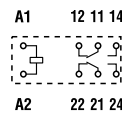

Copper side view



Ordering information

Example: 44 series PCB relay, 2 CO 10 A contacts, 24 V DC coil.

A

4 4 . 6 2 . 9 . 0 2 4 . 0 0 0 0

Series
Type

5 = PCB - 5 mm pinning
6 = PCB - 5 mm pinning

No. of poles

2 = 2 pole for
44.52, 6 A
44.62, 10 A

Coil version

7 = Sensitive DC
9 = DC

Coil voltage

See coil specifications

A: Contact material

0 = Standard AgNi
4 = AgSnO₂
for 44.62 only
5 = AgNi + Au
for 44.52 only

B: Contact circuit

0 = CO (DPDT)

D: Special versions

0 = Flux proof (RT II)

C: Options

0 = None

Selecting features and options: only combinations in the same row are possible.

Preferred selections for best availability are shown in **bold**.

Type	Coil version	A	B	C	D
44.52	DC - sens. DC	0 - 5	0	0	0
44.62	DC - sens. DC	0 - 4	0	0	0

Technical data

Insulation according to EN 61810-1

Nominal voltage of supply system	V AC	230/400	
Rated insulation voltage	V AC	250	400
Pollution degree		3	2

Insulation between coil and contact set

Type of Insulation		Reinforced (8 mm)
Overvoltage category		III
Rated impulse voltage	kV (1.2/50 μs)	6
Dielectric strength	V AC	4000

Insulation between adjacent contacts

Type of insulation		Basic
Overvoltage category		III
Rated impulse voltage	kV (1.2/50 μs)	4
Dielectric strength	V AC	2500

Insulation between open contacts

Type of disconnection		Micro-disconnection
Dielectric strength	V AC/kV (1.2/50 μs)	1000/1.5

Insulation between coil terminals

Rated impulse voltage (surge) differential mode (according to EN 61000-4-5)	kV(1.2/50 μs)	3
---	---------------	---

Other data

Bounce time: NO/NC	ms	4/4	
Vibration resistance (5...55)Hz: NO/NC	g	15/12	
Shock resistance	g	16	
Power lost to the environment	without contact current	W	0.6
	with rated current	W	1.2 (44.52)
Recommended distance between relays mounted on PCB	mm	≥5	

Contact specification

F 44 - Electrical life (AC) v contact current

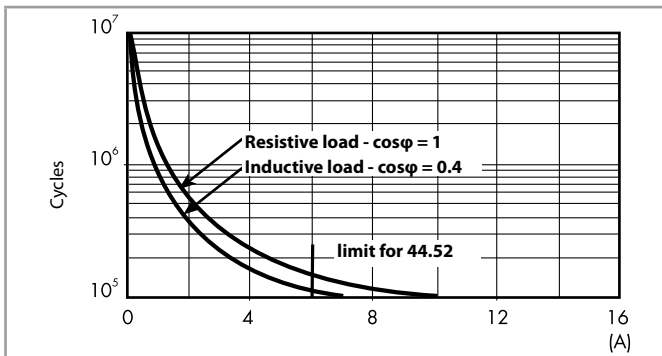

H 44 - Maximum DC1 breaking capacity

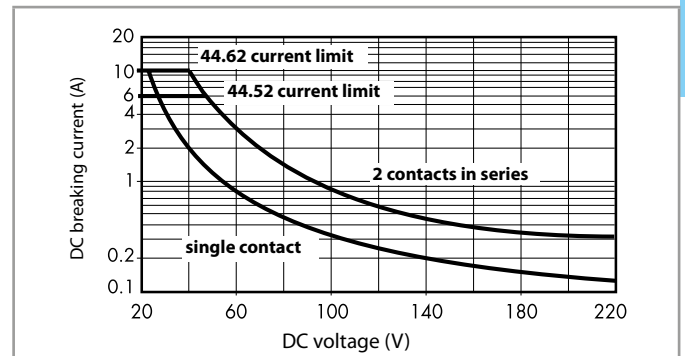

- When switching a resistive load (DC1) having voltage and current values under the curve, an electrical life of $\geq 100 \cdot 10^3$ can be expected.
- In the case of DC13 loads, the connection of a diode in parallel with the load will permit a similar electrical life as for a DC1 load.
Note: the release time for the load will be increased.

Coil specifications

DC coil data - 0.65 W standard

Nominal voltage	Coil code	Operating range		Resistance	Rated coil consumption
		U_{min}	U_{max}		
U_N		V	V	R	I at U_N
V		V	V	Ω	mA
6	9.006	4.4	9	55	109
9	9.009	6.6	13.5	125	72
12	9.012	8.8	18	220	55
14	9.014	10.2	21	300	47
24	9.024	17.5	36	900	27
28	9.028	20.5	42	1200	23
48	9.048	35	72	3500	14
60	9.060	43.8	90	5500	11
110	9.110	80.3	165	18000	6.2
125	9.125	91.2	188	23500	5.3

DC coil data - 0.5 W sensitive

Nominal voltage	Coil code	Operating range		Resistance	Rated coil consumption
		U_{min}	U_{max}		
U_N		V	V	R	I at U_N
V		V	V	Ω	mA
6	7.006	4.4	10.2	75	80
9	7.009	6.6	15.3	160	56
12	7.012	8.8	20.4	300	40
14	7.014	10.2	23.8	400	35
24	7.024	17.5	40.8	1200	20
28	7.028	20.5	47.6	1600	17.5
48	7.048	35	81.6	4800	10
60	7.060	43.8	102	7200	8.4
110	7.110	80.3	187	23500	4.7
125	7.125	100	219	32000	3.9

* $U_{min} = 0.8 U_N$ for 44.62

R 44 - DC coil operating range v ambient temperature

Standard coil

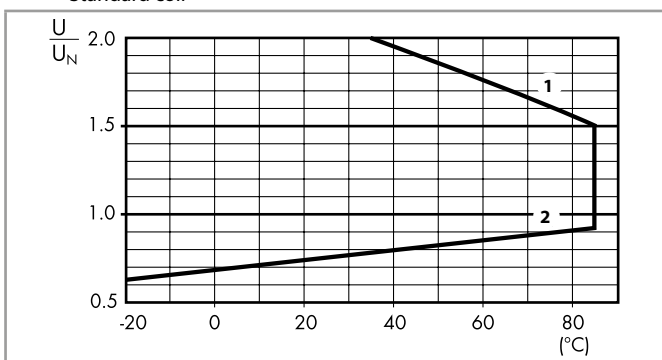

- 1 - Max. permitted coil voltage.
2 - Min. pick-up voltage with coil at ambient temperature.

R 44 - DC coil operating range v ambient temperature

Sensitive coil

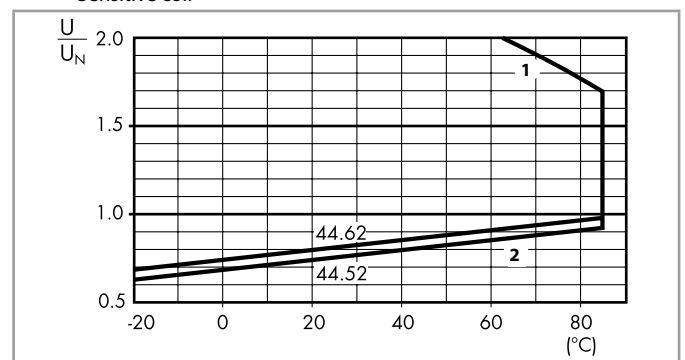

- 1 - Max. permitted coil voltage.
2 - Min. pick-up voltage with coil at ambient temperature.

Outline drawings

Type 44.52/44.62

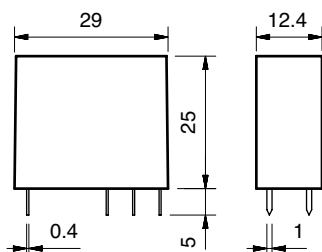

A



95.P5
See page 7

Module	Socket	Relay	Description	Mounting	Accessories
99.02	95.P5	44.52 44.62	Push-in terminal sockets - For fast cable connection - Top terminals - Contacts - Bottom terminals - Coil	Panel or 35 mm rail (EN 60715) mount	- Coil indication and EMC suppression modules - Jumper link - Timer modules - Plastic retaining and release clip

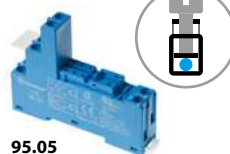

95.05
See page 9

Module	Socket	Relay	Description	Mounting	Accessories
99.02	95.05	44.52 44.62	Screw terminal (Box clamp) socket - Top terminals - Contacts - Bottom terminals - Coil	Panel or 35 mm rail (EN 60715) mount	- Coil indication and EMC suppression modules - Jumper link - Timer modules - Plastic retaining and release clip

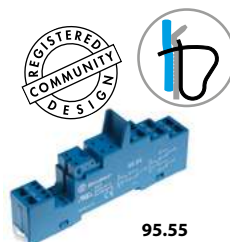

95.55
See page 10

Module	Socket	Relay	Description	Mounting	Accessories
99.02	95.55	44.52 44.62	Screwless terminal socket - For fast cable connections - Top terminals - Contacts - Bottom terminals - Coil	Panel or 35 mm rail (EN 60715) mount	- Coil indication and EMC suppression modules - Timer modules - Plastic retaining and release clip



95.85.3
See page 11

Module	Socket	Relay	Description	Mounting	Accessories
99.80	95.85.3	44.52 44.62	Screw terminal (Box clamp) socket	Panel or 35 mm rail (EN 60715) mount	- Coil indication and EMC suppression modules - Plastic retaining and release clip

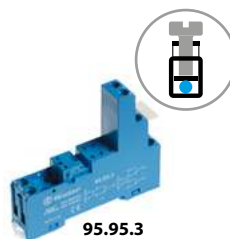

95.95.3
See page 12

Module	Socket	Relay	Description	Mounting	Accessories
99.80	95.95.3	44.52 44.62	Screw terminal (Box clamp) socket - Top terminals - Contacts - Bottom terminals - Coil	Panel or 35 mm rail (EN 60715) mount	- Coil indication and EMC suppression modules - Plastic retaining and release clip

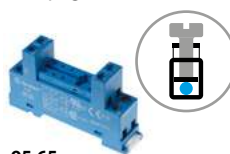

95.65
See page 13

Module	Socket	Relay	Description	Mounting	Accessories
—	95.65	44.52 44.62	Screw terminal (Box clamp) socket	Panel or 35 mm rail (EN 60715) mount	- Metal retaining clip



95.15.2
See page 14

Module	Socket	Relay	Description	Mounting	Accessories
—	95.15.2	44.52 44.62	PCB socket	PCB mounting	- Metal retaining clip

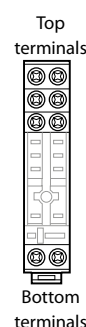

NEW



95.P5
Approvals
(according to type):



095.91.3

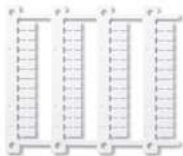

060.48

Push-in terminal socket panel or 35 mm rail mount		95.P5	
For relay type		44.52, 44.62	
Accessories			
Metal retaining clip		095.71	
Plastic retaining and release clip (supplied with socket - packaging code SPA)		095.91.3	
8-way jumper link		097.58	
2-way jumper link (12.5 mm pitch)		097.52	
2-way jumper link (4.6 mm pitch)		097.42	
Marker tag holder (for tags 060.48 type)		097.00	
Identification tag		095.00.4	
Modules (see table below)		99.02	
Timer modules (see table below)		86.30	
Sheet of marker tags for plastic retaining and release clip 095.91.3 and for marker tag holder 097.00, 48 tags, 6 x 12 mm, for CEMBRE thermal transfert printer		060.48	
Technical data			
Rated values		10 A - 250 V	
Dielectric strength		6 kV (1.2/50 μs) between coil and contacts	
Protection category		IP 20	
Ambient temperature		°C -40...+70 (see diagram L95)	
Wire strip length		mm 8	
Min. wire size for 95.P5 socket		solid wire	stranded wire
		mm ² 0.5	0.5
		AWG 21	21
Max. wire size for 95.P5 socket		solid wire	stranded wire
		mm ² 2 x 1.5 / 1 x 2.5	2 x 1.5 / 1 x 2.5
		AWG 2 x 16 / 1 x 14	2 x 16 / 1 x 14

L 95 - Total socket current v ambient temperature

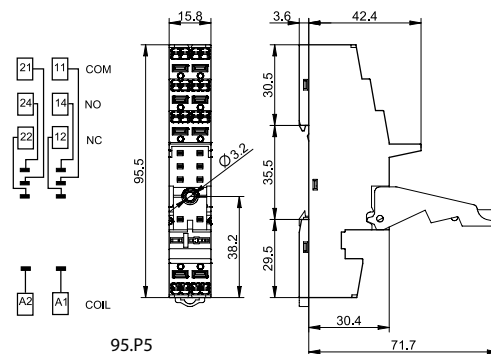
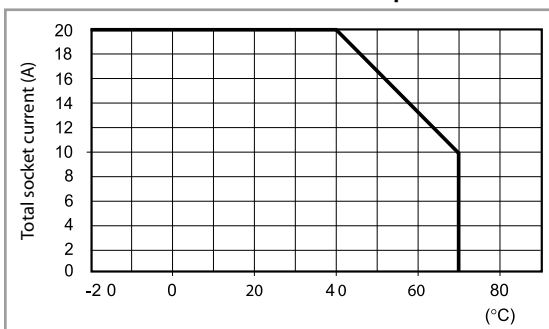

097.58

8-way jumper link for 95.P5 socket	097.58
Rated values	10 A - 250 V

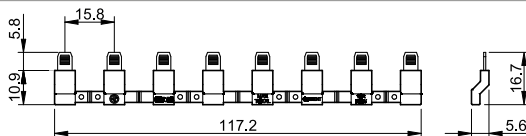

097.52

2-way jumper link for 95.P5 socket	097.52
Rated values	10 A - 250 V

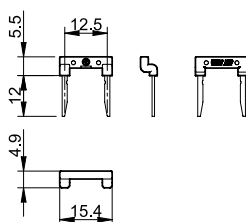

A



097.42

2-way jumper link for 95.P5 socket	097.42
Rated values	10 A - 250 V

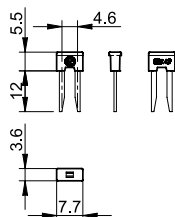

097.00

Marker tag holder for 95.P5 sockets	097.00
--	--------

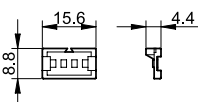

86.30

86 series timer modules	
(12...24)V AC/DC; Bi-function: AI, DI; (0.05 s...100 h)	86.30.0.024.0000
(110...125)V AC; Bi-function: AI, DI; (0.05 s...100 h)	86.30.8.120.0000
(230...240)V AC; Bi-function: AI, DI; (0.05 s...100 h)	86.30.8.240.0000

Approvals (according to type): **CE EAC cRU[®] US**



99.02

Approvals
(according to type):

EAC cRU[®] US

DC Modules with
non-standard polarity
(+A2) on request.

99.02 coil indication and EMC suppression modules for 95.P5 socket		
Diode (+A1, standard polarity)	(6...220)V DC	99.02.3.000.00
LED	(6...24)V DC/AC	99.02.0.024.59
LED	(28...60)V DC/AC	99.02.0.060.59
LED	(110...240)V DC/AC	99.02.0.230.59
LED + Diode (+A1, standard polarity)	(6...24)V DC	99.02.9.024.99
LED + Diode (+A1, standard polarity)	(28...60)V DC	99.02.9.060.99
LED + Diode (+A1, standard polarity)	(110...220)V DC	99.02.9.220.99
LED + Varistor	(6...24)V DC/AC	99.02.0.024.98
LED + Varistor	(28...60)V DC/AC	99.02.0.060.98
LED + Varistor	(110...240)V DC/AC	99.02.0.230.98
RC circuit	(6...24)V DC/AC	99.02.0.024.09
RC circuit	(28...60)V DC/AC	99.02.0.060.09
RC circuit	(110...240)V DC/AC	99.02.0.230.09
Residual current by-pass	(110...240)V AC	99.02.8.230.07



95.05

Approvals (according to type):



Certain relay/socket combinations



095.01

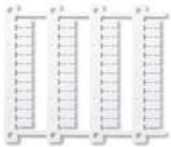

060.48

Screw terminal (Box clamp) socket panel or 35 mm rail mount	95.05 (blue)	95.05.0 (black)
For relay type	44.52, 44.62	
Accessories		
Metal retaining clip	095.71	
Plastic retaining and release clip (supplied with socket - packaging code SPA)	095.01	095.01.0
8-way jumper link	095.18	095.18.0
Marker tag holder (for tags 060.48 type)	097.00	
Identification tag	095.00.4	
Modules (see table below)	99.02	
Timer modules (see table below)	86.30	
Sheet of marker tags for plastic retaining and release clip 095.01 and for marker tag holder 097.00, 48 tags, 6 x 12 mm, for CEMBRE thermal transfer printers	060.48	
Technical data		
Rated values	10 A - 250 V	
Dielectric strength	6 kV (1.2/50 μs) between coil and contacts	
Protection category	IP 20	
Ambient temperature	°C -40...+70 (see diagram L95)	
Screw torque	Nm	0.5
Wire strip length	mm 8	
Max. wire size for 95.05 socket	solid wire	stranded wire
	mm ²	1 x 6 / 2 x 2.5
	AWG	1 x 10 / 2 x 14

L 95 - Total socket current v ambient temperature

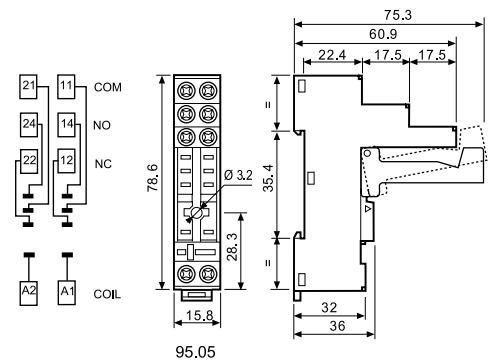
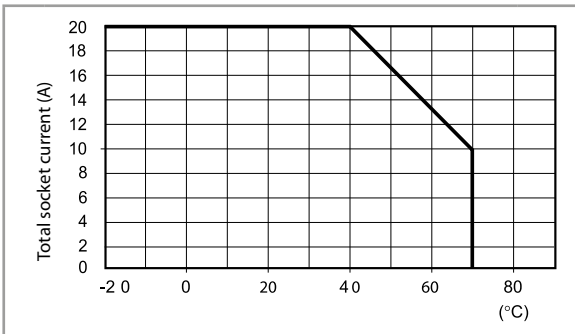

8-way jumper link for 95.05 socket	095.18 (blue)	095.18.0 (black)
Rated values	10 A - 250 V	

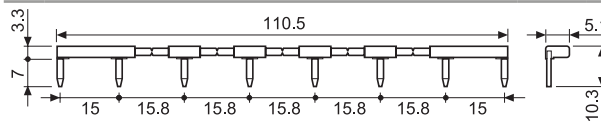

095.18



86 series timer modules (12...24)V AC/DC; Bi-function: AI, DI; (0.05 s...100 h)	86.30.0.024.0000
---	-------------------------

Approvals (according to type):



86.30



99.02

99.02 coil indication and EMC suppression modules for 95.05 socket		
Diode (+A1, standard polarity)	(6...220)V DC	99.02.3.000.00
LED	(6...24)V DC/AC	99.02.0.024.59
LED	(28...60)V DC/AC	99.02.0.060.59
LED	(110...240)V DC/AC	99.02.0.230.59
LED + Diode (+A1, standard polarity)	(6...24)V DC	99.02.9.024.99
LED + Diode (+A1, standard polarity)	(28...60)V DC	99.02.9.060.99
LED + Diode (+A1, standard polarity)	(110...220)V DC	99.02.9.220.99
LED + Varistor	(6...24)V DC/AC	99.02.0.024.98
LED + Varistor	(28...60)V DC/AC	99.02.0.060.98
LED + Varistor	(110...240)V DC/AC	99.02.0.230.98
RC circuit	(6...24)V DC/AC	99.02.0.024.09
RC circuit	(28...60)V DC/AC	99.02.0.060.09
RC circuit	(110...240)V DC/AC	99.02.0.230.09
Residual current by-pass	(110...240)V AC	99.02.8.230.07

Approvals (according to type):



DC Modules with non-standard polarity (+A2) on request.

A



95.55

Approvals
(according to type):



095.91.3

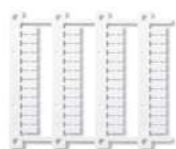

060.48

L 95 - Total socket current v ambient temperature

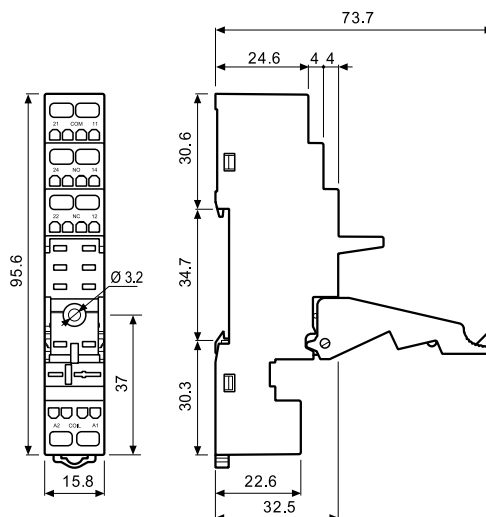
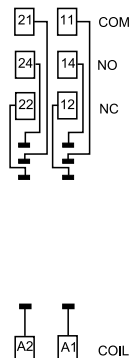
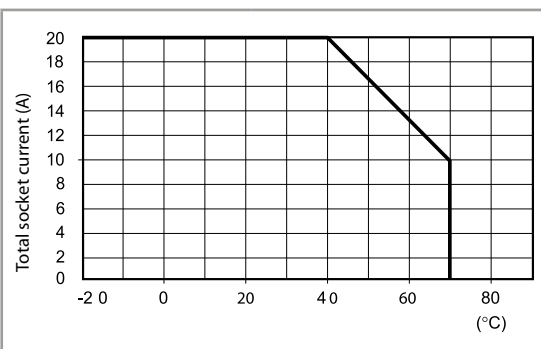

Screwless terminal socket panel or 35 mm rail mount	95.55 (blue)	95.55.0 (black)
For relay type	44.52, 44.62	
Accessories		
Metal retaining clip		095.71
Plastic retaining and release clip (supplied with socket - packaging code SPA)		095.91.3
Modules (see table below)		99.02
Timer modules (see table below)		86.30
Sheet of marker tags for plastic retaining and release clip 095.91.3, 48 tags, 6 x 12 mm, for CEMBRE thermal transfer printers		060.48
Technical data		
Rated values	10 A - 250 V	
Dielectric strength	6 kV (1.2/50 μs) between coil and contacts	
Protection category	IP 20	
Ambient temperature	°C -25...+70 (see diagram L95)	
Wire strip length	mm 8	
Max. wire size for 95.55 socket	solid wire	stranded wire
	mm ² 2 x (0.5...1.5)	2 x (0.5...1.5)
	AWG 2 x (21...18)	2 x (21...18)



86.30

86 series timer modules	
(12...24)V AC/DC; Bi-function: AI, DI; (0.05 s...100 h)	86.30.0.024.0000

Approvals
(according to type):



99.02

99.02 coil indication and EMC suppression modules for 95.55 socket		
Diode (+A1, standard polarity)	(6...220)V DC	99.02.3.000.00
LED	(6...24)V DC/AC	99.02.0.024.59
LED	(28...60)V DC/AC	99.02.0.060.59
LED	(110...240)V DC/AC	99.02.0.230.59
LED + Diode (+A1, standard polarity)	(6...24)V DC	99.02.9.024.99
LED + Diode (+A1, standard polarity)	(28...60)V DC	99.02.9.060.99
LED + Diode (+A1, standard polarity)	(110...220)V DC	99.02.9.220.99
LED + Varistor	(6...24)V DC/AC	99.02.0.024.98
LED + Varistor	(28...60)V DC/AC	99.02.0.060.98
LED + Varistor	(110...240)V DC/AC	99.02.0.230.98
RC circuit	(6...24)V DC/AC	99.02.0.024.09
RC circuit	(28...60)V DC/AC	99.02.0.060.09
RC circuit	(110...240)V DC/AC	99.02.0.230.09
Residual current by-pass	(110...240)V AC	99.02.8.230.07

Approvals
(according to type):



DC Modules with
non-standard polarity
(+A2) on request.

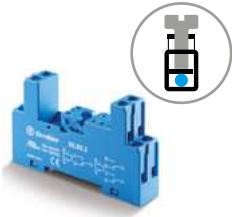

95.85.3

Approvals
(according to type):



095.91.3

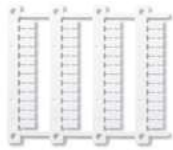

060.48

Screw terminal (Box clamp) socket panel or 35 mm rail mount	95.85.3 (blue)	95.85.30 (black)	
For relay type	44.52, 44.62		
Accessories			
Metal retaining clip	095.71		
Plastic retaining and release clip (supplied with socket - packaging code SPA)	095.91.3	095.91.30	
8-way jumper link	095.08	095.08.0	
Identification tag	095.00.4		
Modules (see table below)	99.80		
Sheet of marker tags for plastic retaining and release clip 095.91.3, 48 tags, 6 x 12 mm, for CEMBRE thermal transfert printer	060.48		
Technical data			
Rated values	10 A - 250 V		
Dielectric strength	6 kV (1.2/50 μs) between coil and contacts		
Protection category	IP 20		
Ambient temperature	°C -40...+70 (see diagram L95)		
Screw torque	Nm	0.5	
Wire strip length	mm	7	
Max. wire size for 95.85.3 socket	solid wire	stranded wire	
	mm ²	1 x 6 / 2 x 2.5	1 x 4 / 2 x 2.5
	AWG	1 x 10 / 2 x 14	1 x 12 / 2 x 14

L 95 - Total socket current v ambient temperature

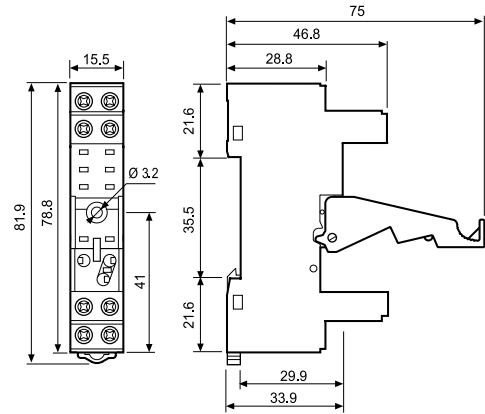
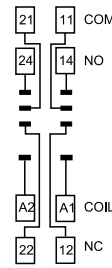
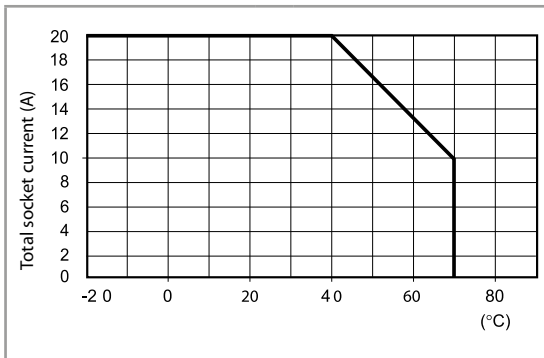

095.08



8-way jumper link for 95.85.3 socket	095.08 (blue)	095.08.0 (black)
Rated values	10 A - 250 V	

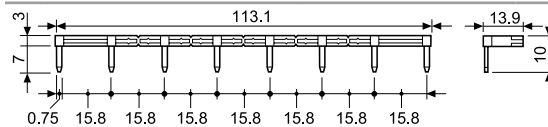

99.80



Approvals
(according to type):



* Modules in Black housing are available on request.
Green LED is standard.
Red LED available on request.

99.80 coil indication and EMC suppression modules for 95.85.3 socket		Blue*
Diode (+A1, standard polarity)	(6...220)V DC	99.80.3.000.00
LED	(6...24)V DC/AC	99.80.0.024.59
LED	(28...60)V DC/AC	99.80.0.060.59
LED	(110...240)V DC/AC	99.80.0.230.59
LED + Diode (+A1, standard polarity)	(6...24)V DC	99.80.9.024.99
LED + Diode (+A1, standard polarity)	(28...60)V DC	99.80.9.060.99
LED + Diode (+A1, standard polarity)	(110...220)V DC	99.80.9.220.99
LED + Varistor	(6...24)V DC/AC	99.80.0.024.98
LED + Varistor	(28...60)V DC/AC	99.80.0.060.98
LED + Varistor	(110...240)V DC/AC	99.80.0.230.98
RC circuit	(6...24)V DC/AC	99.80.0.024.09
RC circuit	(28...60)V DC/AC	99.80.0.060.09
RC circuit	(110...240)V DC/AC	99.80.0.230.09
Residual current by-pass	(110...240)V AC	99.80.8.230.07

A

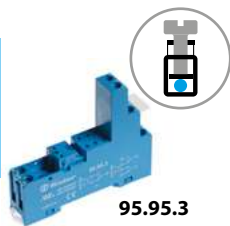

95.95.3

Approvals
(according to type):



095.91.3

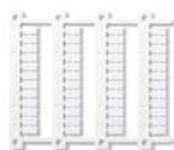

060.48

Screw terminal (Box clamp) socket panel or 35 mm rail mount	95.95.3 (blue)	95.95.30 (black)
For relay type	44.52, 44.62	
Accessories		
Metal retaining clip	095.71	
Plastic retaining and release clip (supplied with socket - packaging code SPA)	095.91.3	095.91.30
8-way jumper link	095.08	095.08.0
Identification tag	095.00.4	
Modules (see table below)	99.80	
Sheet of marker tags for plastic retaining and release clip 095.91.3 and for marker tag holder 097.00, 48 tags, 6 x 12 mm, for CEMBRE thermal transfer printers	060.48	
Technical data		
Rated values	10 A - 250 V	
Dielectric strength	6 kV (1.2/50 μs) between coil and contacts	
Protection category	IP 20	
Ambient temperature	°C -40...+70 (see diagram L95)	
Screw torque	Nm 0.5	
Wire strip length	mm 8	
Max. wire size for 95.95.3 socket	solid wire	stranded wire
	mm ²	1 x 6 / 2 x 2.5
	AWG	1 x 10 / 2 x 14

L 95 - Total socket current v ambient temperature

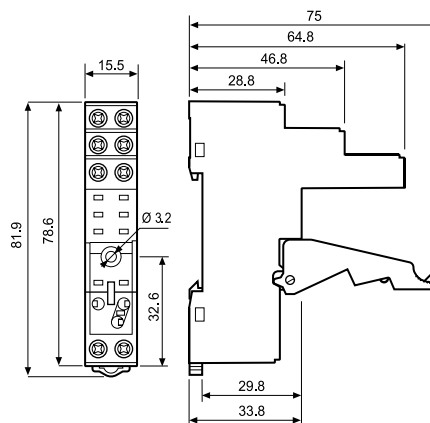
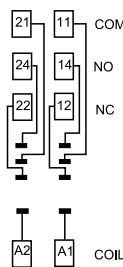
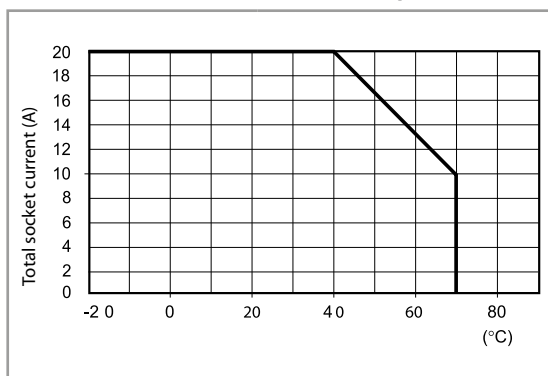

95.08



8-way jumper link for 95.95.3 socket	095.08 (blue)	095.08.0 (black)
Rated values	10 A - 250 V	

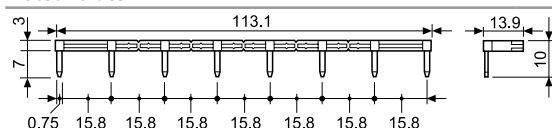

99.80

Approvals
(according to type):



* Modules in Black housing are available on request.

Green LED is standard.
Red LED available on request.

99.80 coil indication and EMC suppression modules for 95.95.3 socket		Blue*
Diode (+A1, standard polarity)	(6...220)V DC	99.80.3.000.00
LED	(6...24)V DC/AC	99.80.0.024.59
LED	(28...60)V DC/AC	99.80.0.060.59
LED	(110...240)V DC/AC	99.80.0.230.59
LED + Diode (+A1, standard polarity)	(6...24)V DC	99.80.9.024.99
LED + Diode (+A1, standard polarity)	(28...60)V DC	99.80.9.060.99
LED + Diode (+A1, standard polarity)	(110...220)V DC	99.80.9.220.99
LED + Varistor	(6...24)V DC/AC	99.80.0.024.98
LED + Varistor	(28...60)V DC/AC	99.80.0.060.98
LED + Varistor	(110...240)V DC/AC	99.80.0.230.98
RC circuit	(6...24)V DC/AC	99.80.0.024.09
RC circuit	(28...60)V DC/AC	99.80.0.060.09
RC circuit	(110...240)V DC/AC	99.80.0.230.09
Residual current by-pass	(110...240)V AC	99.80.8.230.07



95.65

Approvals
(according to type):



Screw terminal (Box clamp) socket panel or 35 mm rail mount	95.65 (blue)	
For relay type	44.52, 44.62	
Accessories		
Metal retaining clip	095.71	
8-way jumper link	095.08	
Modules	—	
Technical data		
Rated values	10 A - 250 V	
Dielectric strength	2 kV AC	
Protection category	IP 20	
Ambient temperature	°C -40...+70 (see diagram L95)	
Screw torque	Nm	0.5
Wire strip length	mm	7
Max. wire size for 95.65 socket	solid wire	stranded wire
	mm ²	1 x 6 / 2 x 2.5
	AWG	1 x 10 / 2 x 14

L 95 - Total socket current v ambient temperature

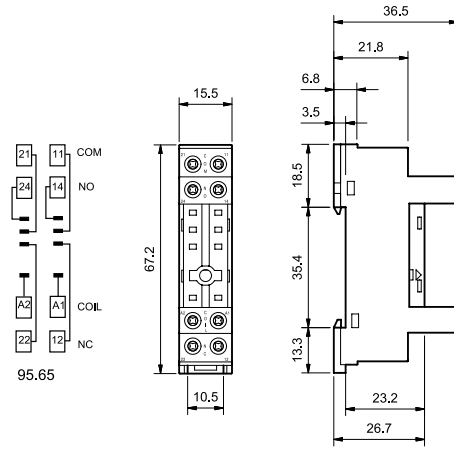
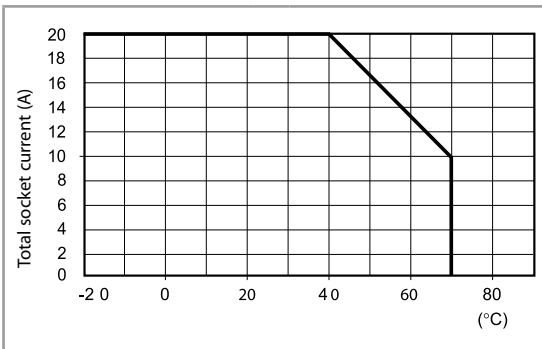

095.08



8-way jumper link for 95.65 socket	095.08 (blue)
Rated values	10 A - 250 V



A

95.15.2

Approvals
(according to type):

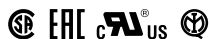

PCB socket	95.15.2 (blue)	95.15.20 (black)
For relay type	44.52, 44.62	
Accessories		
Metal retaining clip (supplied with socket - packaging code SMA)		095.51
Plastic retaining clip		095.52
Technical data		
Rated values	10 A - 250 V	
Dielectric strength	6 kV (1.2/50 μs) between coil and contacts	
Protection category	IP 20	
Ambient temperature	°C -40...+70	

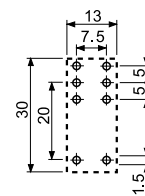
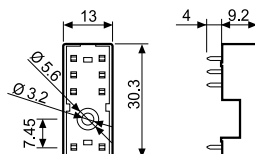
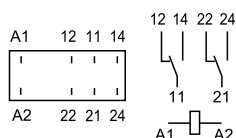

Copper side view

Packaging codes

How to code and identify retaining clip and packaging options for sockets.

Example:



A Standard packaging

SM Metal retaining clip
SP Plastic retaining clip



finder[®]
SWITCH TO THE FUTURE

45
SERIES

Miniature PCB Relays 10 - 16 A



Burners, boilers
and furnaces



Film projectors



Infrared and
microwave
ovens



Jacuzzis and
hot tubs

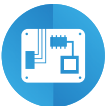

Electronic
circuit boards

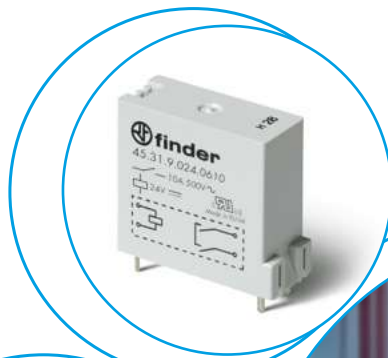

- Relay for +105 °C ambient use**
PCB mount - high contact gap
- **45.31...x310, 1 Pole normally open** (≥ 3 mm contact gap)
 - **45.31...0610, 1 Pole normally open** (≥ 3.6 mm contact gap)
- Contact gap ≥ 3 mm or ≥ 3.6 mm according to EN 60730-1
 - Sensitive DC coil - 360 mW (45.31...x310 type)
 - Cadmium Free contact material
 - Reinforced insulation between coil and contacts according to EN 60335-1, EN 50178, EN 60204 with safe separation and 8 mm clearance and creepage distance
 - 6 kV (1.2/50 μ s) isolation, coil-contacts
 - Flux proof: RT II

NEW 45.31...x310



- 1 NO (SPST-NO), ≥ 3 mm gap
- Max ambient temperature +105 °C
- PCB mounting

NEW 45.31...0610



- 1 NO (SPST-NO), ≥ 3.6 mm gap
- Max ambient temperature +105 °C
- PCB mounting

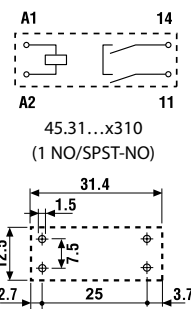

Copper side view

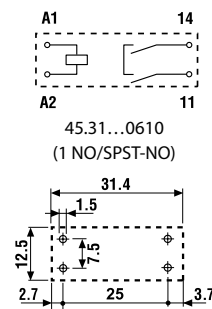

Copper side view

For outline drawing see page 7

FOR UL RATINGS SEE:
"General technical information" page V

Contact specification			
Contact configuration		1NO (SPST-NO) ≥ 3 mm gap	1NO (SPST-NO) ≥ 3.6 mm gap
Rated current/Maximum peak current	A	16/30	10/30
Rated voltage/ Maximum switching voltage	V AC	250/400	500/500
Rated load AC1	VA	4000	5000
Rated load AC15 (230 V AC)	VA	750	750
Single phase motor rating (230 V AC)	kW	0.55	0.55
Breaking capacity DC1: 30/110/220 V	A	16/4/1	10/4/1
Minimum switching load	mW (V/mA)	500 (10/5)	500 (10/5)
Standard contact material		AgNi	AgNi
Coil specification			
Nominal voltage (U_N)	V AC (50/60 Hz)	—	—
	V DC	6 - 12 - 24 - 48 - 60	6 - 12 - 24 - 48 - 60
Rated power AC/DC	VA (50 Hz)/W	—/0.36	—/0.55
Operating range	AC	—	—
	DC	(0.7...1.2) U_N	(0.8...1.2) U_N
Holding voltage	AC/DC	—/0.4 U_N	—/0.4 U_N
Must drop-out voltage	AC/DC	—/0.1 U_N	—/0.1 U_N
Technical data			
Mechanical life AC/DC	cycles	—/10 · 10 ⁶	—/2 · 10 ⁶
Electrical life at rated load AC1	cycles	30 · 10 ³	10 · 10 ³
Operate/release time	ms	12/2	12/2
Insulation between coil and contacts (1.2/50 μ s)	kV	6 (8 mm)	6 (8 mm)
Dielectric strength between open contacts	V AC	2500	3000
Ambient temperature range	°C	−40...+105	−40...+105
Environmental protection		RT II	RT II
Approvals (according to type)			

A

Relays for +125 °C ambient use

PCB mount - Faston 250 contact connections

- 45.71, 1 Pole normally open or normally closed

- 45.91, 1 Pole normally open (≥ 3 mm contact gap)

- Contact gap ≥ 3 mm according to EN 60730-1 (45.91 type)
- Sensitive DC coil - 360 mW
- Cadmium Free option available
- Reinforced insulation between coil and contacts according to EN 60335-1, EN 50178, EN 60204 with safe separation and 8 mm clearance and creepage distance
- 6 kV (1.2/50 μs) isolation, coil-contacts
- Flux proof: RT II standard, (RT III option)

45.71



45.91



- 1 NO or 1 NC (SPST-NO or SPST-NC)
- Max ambient temperature +125 °C
- PCB mounting + Faston 250

- 1 NO (SPST-NO), ≥ 3 mm gap
- Max ambient temperature +125 °C
- PCB mounting + Faston 250

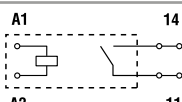

45.71...0310
(1 NO)/(SPST-NO)

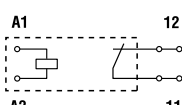

45.71...0410
(1 NC)/(SPST-NC)

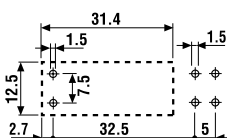

Copper side view

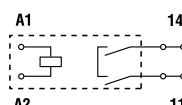

45.91...0310
(1 NO/SPST-NO)

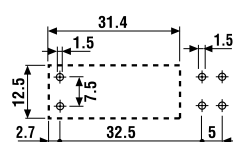

Copper side view

For outline drawing see page 7

FOR UL RATINGS SEE:

"General technical information" page V

Contact specification

Contact configuration		1NO or 1NC (SPST-NO or SPST-NC)	1NO (SPST-NO) ≥ 3 mm gap
Rated current/Maximum peak current	A	16/30	16/30
Rated voltage/ Maximum switching voltage	V AC	250/400	250/400
Rated load AC1	VA	4000	4000
Rated load AC15 (230 V AC)	VA	750	750
Single phase motor rating (230 V AC)	kW	0.55	0.55
Breaking capacity DC1: 30/110/220 V	A	16/0.3/0.13	16/4/1
Minimum switching load	mW (V/mA)	500 (10/5)	500 (10/5)
Standard contact material		AgCdO	AgNi

Coil specification

Nominal voltage (U _N)	V AC (50/60 Hz)	—	—
	V DC	6 - 12 - 24 - 48 - 60	6 - 12 - 24 - 48 - 60
Rated power AC/DC	VA (50 Hz)/W	—/0.36	—/0.36
Operating range	AC	—	—
	DC	(0.7...1.2)U _N	(0.7...1.2)U _N
Holding voltage	AC/DC	—/0.4 U _N	—/0.4 U _N
Must drop-out voltage	AC/DC	—/0.1 U _N	—/0.1 U _N

Technical data

Mechanical life AC/DC	cycles	—/10 · 10 ⁶	—/10 · 10 ⁶
Electrical life at rated load AC1	cycles	100 · 10 ³	30 · 10 ³
Operate/release time	ms	10/2	12/2
Insulation between coil and contacts (1.2/50 μs)	kV	6 (8 mm)	6 (8 mm)
Dielectric strength between open contacts	V AC	1000	2500
Ambient temperature range	°C	−40...+125	−40...+125
Environmental protection		RT II	RT II

Approvals (according to type)

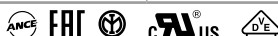

Ordering information

Example: 45 series for PCB relay + Faston 250, 1 NO (SPST-NO), 12 V DC coil.

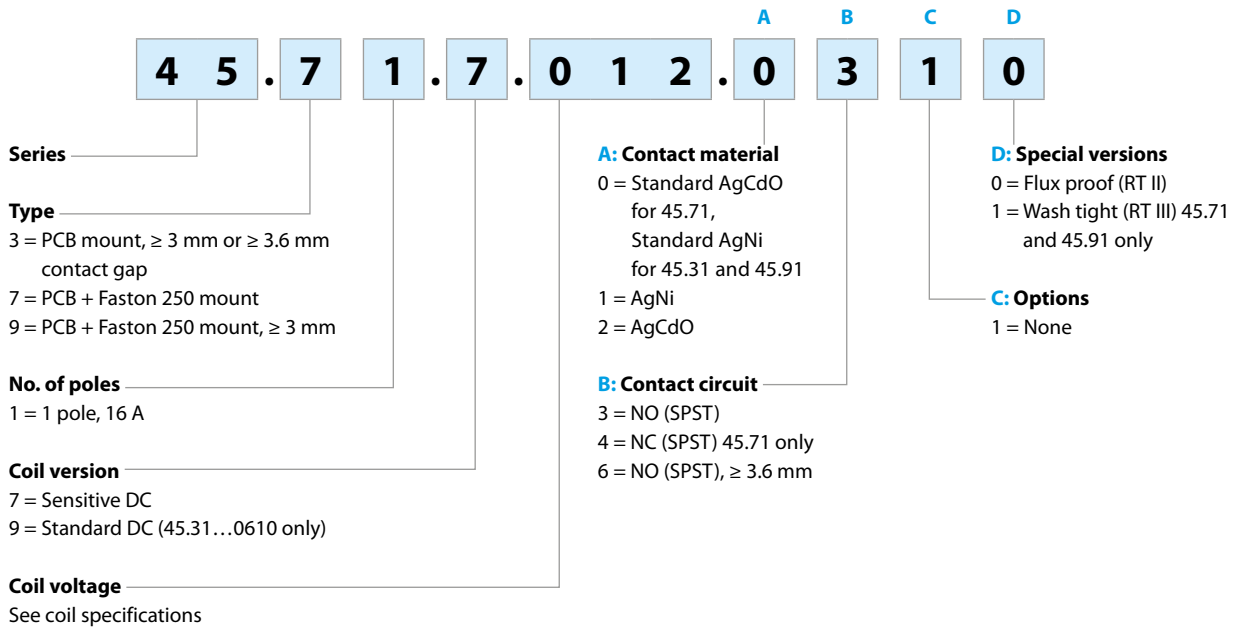

Selecting features and options: only combinations in the same row are possible.

Type	Coil version	A	B	C	D
45.31	sensitive DC	0 - 2	3	1	0
	standard DC	0	6	1	0
45.71	sensitive DC	0 - 1	3 - 4	1	0 - 1
45.91	sensitive DC	0 - 2	3	1	0 - 1

Technical data

Insulation according to EN 61810-1		45.71		45.31 / 45.91	
Nominal voltage of supply system	V AC	230/400		230/400	
Rated insulation voltage	V AC	250	400	250	400
Pollution degree		3	2	3	2
Insulation between coil and contact set					
Type of insulation		Reinforced (8 mm)		Reinforced (8 mm)	
Overvoltage category		III		III	
Rated impulse voltage	kV (1.2/50 μ s)	6		6	
Dielectric strength	V AC	4000		4000	
Insulation between open contacts					
Type of disconnection		Micro-disconnection		Full-disconnection	
Overvoltage category		—		III	
Rated impulse voltage	kV (1.2/50 μ s)	—		4	
Dielectric strength	V AC/kV (1.2/50 μ s)	1000/1.5		2500/4	
Conducted disturbance immunity					
Burst (5...50)ns, 5 kHz, on A1 - A2 according to EN 61000-4-4		level 4 (4 kV)			
Surge (1.2/50 μ s) on A1 - A2 (differential mode) according to EN 61000-4-5		level 3 (2 kV)			
Other data		45.71		45.31 / 45.91	
Bounce time: NO/NC	ms	3/3		2/—	
Vibration resistance (10...150)Hz: NO/NC	g	20/10		20/—	
Shock resistance	g	20			
	W	0.4			
Power lost to the environment	without contact current	W 0.4			
	with rated current	W 1.8			
Recommended distance between relays mounted on PCB	mm	≥ 5			

Contact specification

F 45 - Electrical life (AC) v contact current

Type 45.71

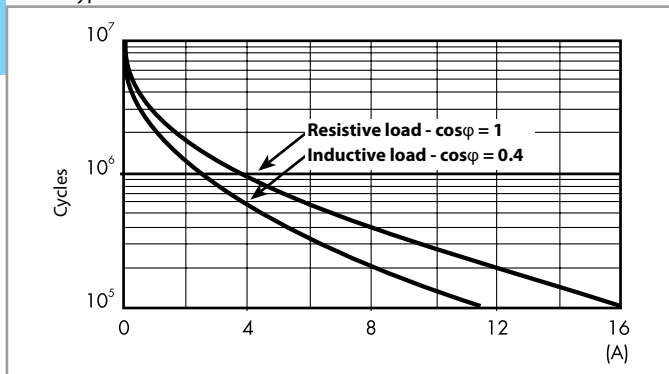

F 45 - Electrical life (AC) v contact current

Type 45.31/45.91

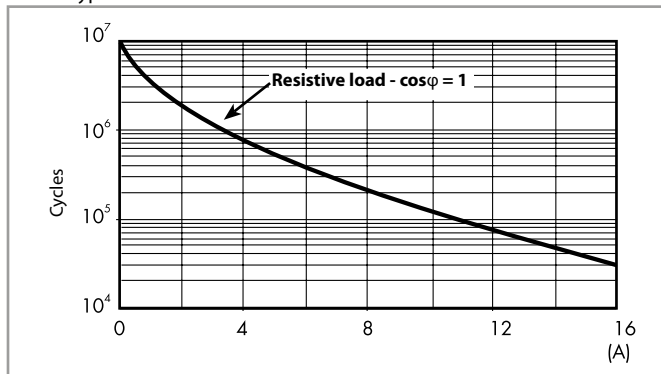

H 45 - Maximum DC1 breaking capacity

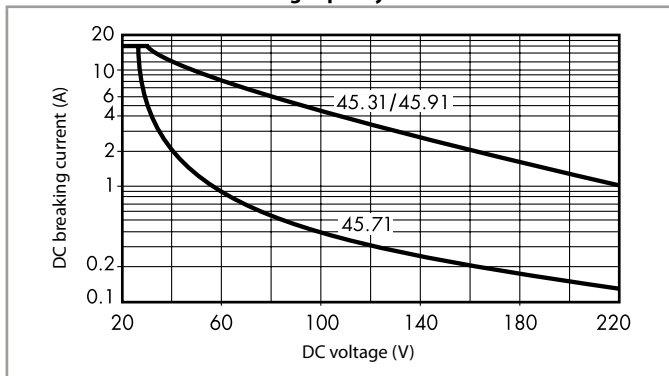

- When switching a resistive load (DC1) having voltage and current values under the curve, an electrical life of $\geq 100 \cdot 10^3$ cycles (45.71) and $\geq 30 \cdot 10^3$ cycles (45.31, 45.91) can be expected.
- In the case of DC13 loads, the connection of a diode in parallel with the load will permit a similar electrical life as for a DC1 load. Note: the release time for the load will be increased.

Coil specifications

DC coil data - 0.36 W sensitive

Nominal voltage U_N	Coil code	Operating range		Resistance R	Rated coil consumption I at U_N
		U_{min}	U_{max}		
V		V	V	Ω	mA
6	7.006	4.2	7.2	100	60
12	7.012	8.4	14.4	400	30
24	7.024	16.8	28.8	1600	15
48	7.048	33.6	57.6	6400	7.5
60	7.060	42	72	10000	6

DC coil data - 0.55 W standard

Nominal voltage U_N	Coil code	Operating range		Resistance R	Rated coil consumption I at U_N
		U_{min}	U_{max}		
V		V	V	Ω	mA
6	9.006	4.2	7.2	72	83
12	9.012	8.4	14.4	300	40
24	9.024	16.8	28.8	1150	21
48	9.048	33.6	57.6	4400	11
60	9.060	42	72	7200	8.3

R 45 - DC coil operating range v ambient temperature

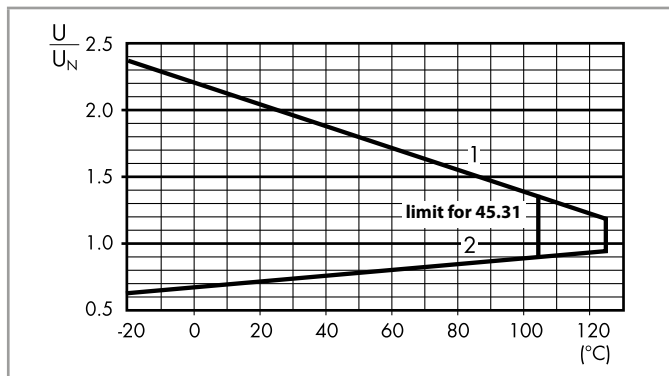

- 1 - Max. permitted coil voltage.
- 2 - Min. pick-up voltage with coil at ambient temperature.

Outline drawings

Type 45.31

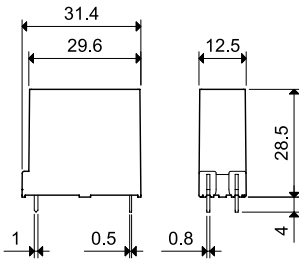

Type 45.71/91

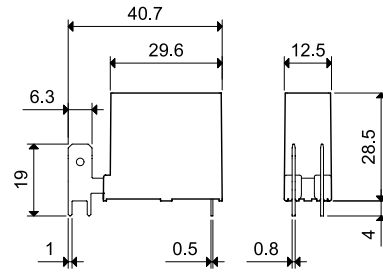

A



Miniature Industrial relay 8 - 16 A



Automation for
blinds, grilles
and shutters



Elevators and lifts



Shipyards



Road / tunnel
lighting



Hoists and
cranes



Bottling plant



Control panels



Panels for electrical
distribution

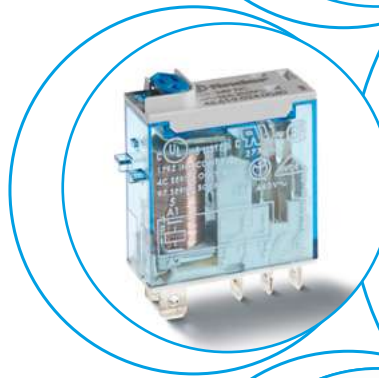
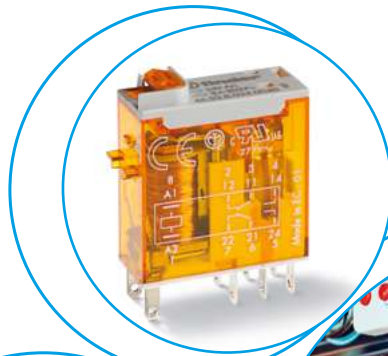

1 & 2 CO industrial style power relays
For socket mount or direct connection via
Faston connectors

Type 46.52

- 2 CO 8 A

Type 46.61

- 1 CO 16 A

- AC coils & DC coils
- Available with: lockable test button, mechanical indicator & LED indicator
- 8 mm, 6 kV (1.2/50 μs) isolation, coil-contacts
- Cadmium free contacts
- 97 series 35 mm rail (EN 60715) Screw, Screwless or Push-in terminals, and PCB mount sockets
- Coil Indication and EMC suppression modules 99 series and Timer module 86.30 options
- Optional alternative mounting adaptors
- European Patent

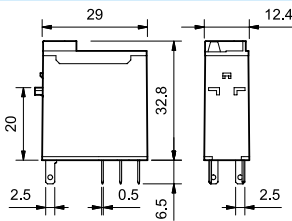

46.52

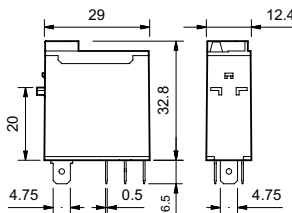

46.61

FOR UL RATINGS SEE:

"General technical information" page V

Contact specification

Contact configuration		2 CO (DPDT)	1 CO (SPDT)
Rated current/Maximum peak current	A	8/15	16/25*
Rated voltage/ Maximum switching voltage	V AC	250/440	250/440
Rated load AC1	VA	2000	4000
Rated load AC15 (230 V AC)	VA	350	750
Single phase motor rating (230 V AC)	kW	0.37	0.55
Breaking capacity DC1: 30/110/220 V	A	6/0.5/0.15	12/0.5/0.15
Minimum switching load	mW (V/mA)	300 (5/5)	300 (5/5)
Standard contact material		AgNi	AgNi

Coil specification

Nominal voltage (U _N)	V AC (50/60 Hz)	12 - 24 - 48 - 110 - 120 - 230 - 240
	V DC	12 - 24 - 48 - 110 - 125
Rated power	VA/W	1.2/0.5
Operating range	AC	(0.8...1.1)U _N
	DC	(0.73...1.1)U _N
Holding voltage	AC/DC	0.8 U _N / 0.4 U _N
Must drop-out voltage	AC/DC	0.2 U _N / 0.1 U _N

Technical data

Mechanical life AC/DC	cycles	10 · 10 ⁶	10 · 10 ⁶
Electrical life at rated load AC1	cycles	100 · 10 ³	100 · 10 ³
Operate/release time	ms	10/3	15/5
Insulation between coil and contacts (1.2/50 μs)	kV	6 (8 mm)	6 (8 mm)
Dielectric strength between open contacts	V AC	1000	1000
Ambient temperature range	°C	-40...+70	-40...+70
Environmental protection		RT II	RT II

Approvals (according to type)

46.52

- 2 CO 8 A
- Plug-in/Solder terminals

46.61

- 1 CO 16 A
- Plug-in/Faston 187

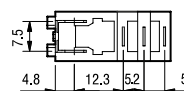
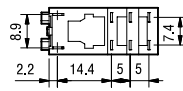
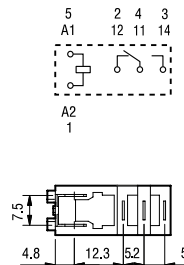
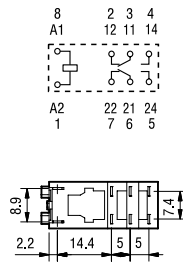

* With the AgSnO₂ material the maximum peak current is 80 A - 5 ms on normally open contact.

Ordering information

Example: 46 series Miniature industrial relay, 1 CO, 24 V DC coil, lockable test button and mechanical indicator.

A

<p>Series —————</p> <p>Type ————— 5 = Spade/blade solder terminal (2.5 x 0.5)mm 6 = Spade/blade terminal Faston 187 (4.8 x 0.5)mm</p> <p>No. of poles ————— 1 = 1 pole, 16 A 2 = 2 poles, 8 A</p> <p>Coil version ————— 9 = DC 8 = AC (50/60 Hz)</p> <p>Coil voltage ————— See coil specifications</p>	<p>4 6 . 6 1 . 9 . 0 2 4 . 0 0 4 0</p>	<p>A: Contact material 0 = AgNi 4 = AgSnO₂ (46.61 only) 5 = AgNi + Au</p> <p>B: Contact circuit 0 = CO (nPDT)</p>	<p>D: Special versions 0 = Standard</p> <p>C: Options 2 = Mechanical indicator 4 = Lockable test button + mechanical indicator 54 = Lockable test button + LED (AC) + mechanical indicator 74 = Lockable test button + double LED (DC non-polarized) + mechanical indicator</p>
---	---	--	---

Selecting features and options: only combinations in the same row are possible.
Preferred selections for best availability are shown in **bold**.

Type	Coil version	A	B	C	D
46.52	AC - DC	0 - 5	0	2 - 4	0
	AC	0 - 5	0	54	/
	DC	0 - 5	0	74	/
46.61	AC - DC	0 - 4 - 5	0	2 - 4	0
	AC	0 - 4 - 5	0	54	/
	DC	0 - 4 - 5	0	74	/

Special versions for Rail Applications on request

Descriptions: Options

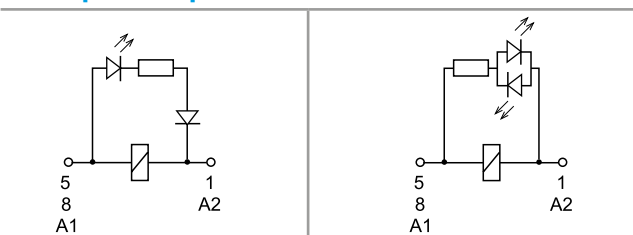

C: Option 54
LED (AC)

C: Option 74
LED (DC, non-polarized)



Lockable test button and mechanical flag indicator (0040, 0054, 0074)

The dual-purpose Finder test button can be used in two ways:

Case 1) The plastic pip (located directly below the test button) remains intact. In this case, when the test button is pushed, the contacts operate. When the test button is released the contacts return to their former state.

Case 2) The plastic pip is broken-off (using an appropriate cutting tool). In this case, (in addition to the above function), when the test button is pushed and rotated, the contacts are latched in the operating state, and remain so until the test button is rotated back to its former position.

In both cases ensure that the test button actuation is swift and decisive.



Technical data

Insulation according to EN 61810-1		1 pole		2 pole	
Nominal voltage of supply system	V AC	230/400		230/400	
Rated insulation voltage	V AC	250	400	250	400
Pollution degree		3	2	3	2
Insulation between coil and contact set					
Type of Insulation		Reinforced (8 mm)		Reinforced (8 mm)	
Overvoltage category		III		III	
Rated impulse voltage	kV (1.2/50 μ s)	6		6	
Dielectric strength	V AC	4000		4000	
Insulation between adjacent contacts					
Type of insulation		—		Basic	
Overvoltage category		—		III	
Rated impulse voltage	kV (1.2/50 μ s)	—		4	
Dielectric strength	V AC	—		2000	
Insulation between open contacts					
Type of disconnection		Micro-disconnection		Micro-disconnection	
Dielectric strength	V AC/kV (1.2/50 μ s)	1000/1.5		1000/1.5	
Conducted disturbance immunity					
Burst (5...50)ns, 5 kHz, on A1 - A2 according to EN 61000-4-4		level 4 (4 kV)			
Surge (1.2/50 μ s) on A1 - A2 (differential mode) according to EN 61000-4-5		level 3 (2 kV)			
Other data		46.61		46.52	
Bounce time: NO/NC	ms	2/6		1/4	
Vibration resistance (10...150)Hz: NO/NC	g	20/12		20/15	
Shock resistance	g	20		20	
Power lost to the environment	without contact current	W	0.6		0.6
	with rated current	W	1.6		2
Recommended distance between relays mounted on PCB	mm	≥ 5			

Contact specification

F 46 - Electrical life (AC) v contact current

Type 46.52

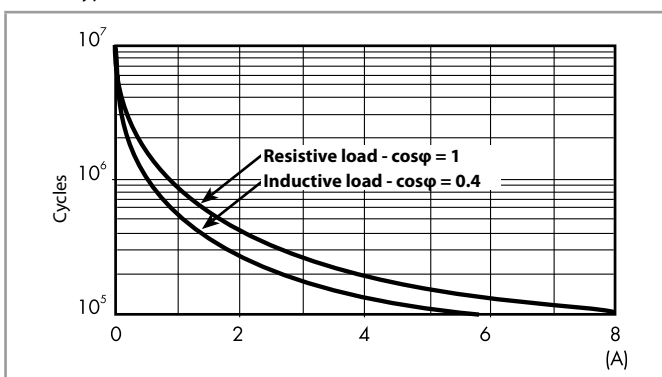

F 46 - Electrical life (AC) v contact current

Type 46.61

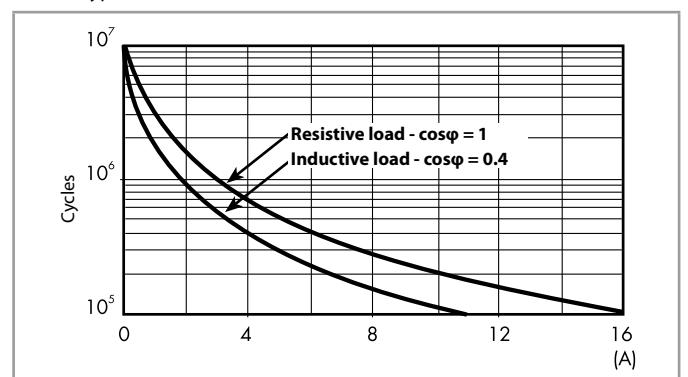

H 46 - Maximum DC1 breaking capacity

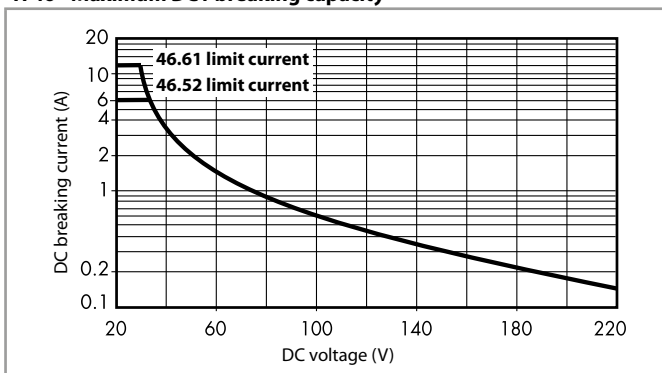

- When switching a resistive load (DC1) having voltage and current values under the curve, an electrical life of $\geq 100 \cdot 10^3$ can be expected.
- In the case of DC13 loads, the connection of a diode in parallel with the load will permit a similar electrical life as for a DC1 load.
Note: the release time for the load will be increased.

Coil specifications

A

DC coil data

Nominal voltage U_N V	Coil code	Operating range		Resistance R Ω	Rated coil consumption I at U_N mA
		U_{min} V	U_{max} V		
12	9.012	8.8	13.2	300	40
24	9.024	17.5	26.4	1200	20
48	9.048	35	52.8	4800	10
110	9.110	80	121	23500	4.7
125	9.125	91.2	138	32000	3.9

AC coil data

Nominal voltage U_N V	Coil code	Operating range		Resistance R Ω	Rated coil consumption I at U_N mA
		U_{min} V	U_{max} V		
12	8.012	9.6	13.2	80	90
24	8.024	19.2	26.4	320	45
48	8.048	38.4	52.8	1350	21
110	8.110	88	121	6900	9.4
120	8.120	96	132	9000	8.4
230	8.230	184	253	28000	5
240	8.240	192	264	31500	4.1

R 46 - DC coil operating range v ambient temperature

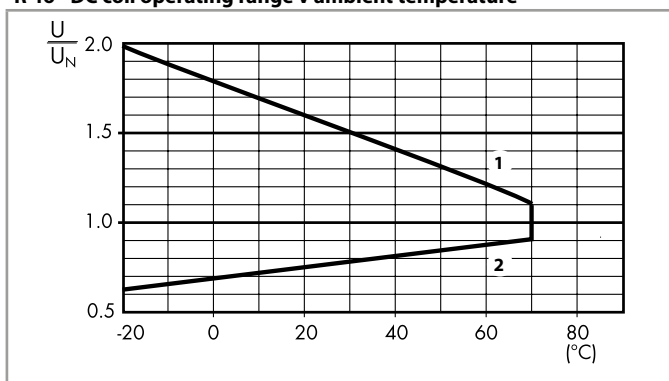

- 1 - Max. permitted coil voltage.
- 2 - Min. pick-up voltage with coil at ambient temperature.

R 46 - AC coil operating range v ambient temperature

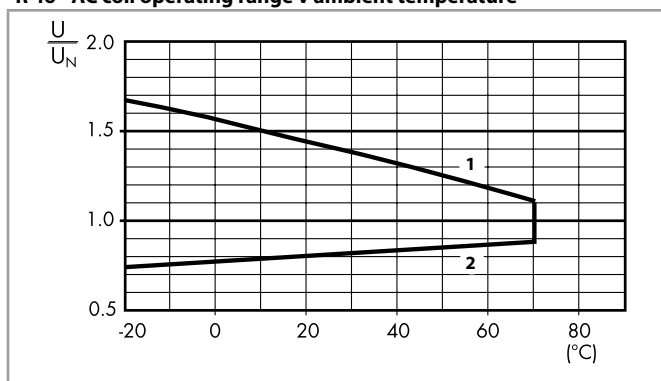

- 1 - Max. permitted coil voltage.
- 2 - Min. pick-up voltage with coil at ambient temperature.

Accessories



046.05

Flange mount adaptor for relays types 46.52 and 46.61

046.05



046.05 with relay

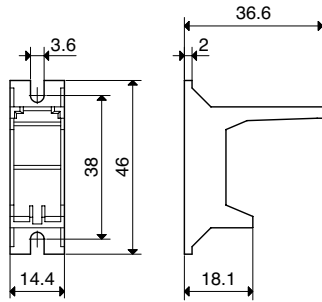

046.05

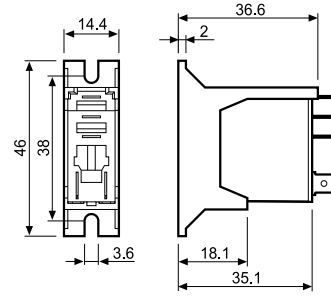

046.05 with relay



046.07

35 mm rail adaptor for relays types 46.52 and 46.61

046.07



046.07 with relay

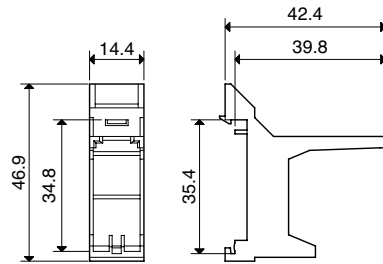

046.07

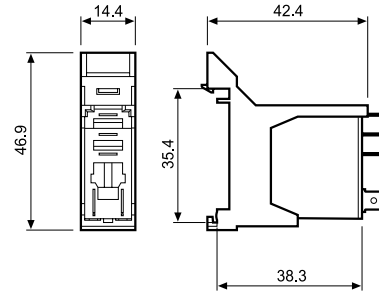

046.07 with relay

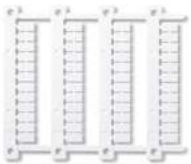

060.48

Sheet of marker tags (CEMBRE Thermal transfer printers) for relays types 46.52 and 46.61 (48 tags), 6 x 12 mm

060.48

A

A



97.P2

Approvals
(according to type):



097.01

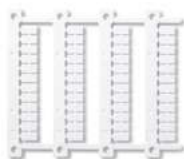

060.48

Push-in terminal socket panel or 35 mm rail (EN 60715) mount	97.P1	97.P2
For relay type	46.61	46.52
Accessories		
Plastic retaining and release clip (supplied with socket - packaging code SPA)		097.01
Metal retaining clip		097.71
Identification tag		095.00.4
8-way jumper link		097.58
2-way jumper link		097.52
2-way jumper link		097.42
Marker tag holder		097.00
Modules (see table below)		99.02
Timer modules (see table below)		86.30
Sheet of marker tags for marker tag holder 097.00, 48 tags, 6 x 12 mm, for CEMBRE thermal transfer printers		060.48
Technical data		
Rated values	10 A-250 V AC	8 A-250 V AC
Dielectric strength	6 kV (1.2/50 μs) between coil and contacts	
Protection category	IP 20	
Ambient temperature	°C -40...+70	
Wire strip length	mm 8	
Min. wire size for 97.P1 and 97.P2 socket	solid wire	stranded wire
	mm ² 0.5	0.5
	AWG 21	21
Max. wire size for 97.P1 and 97.P2 socket	solid wire	stranded wire
	mm ² 2 x 1.5 / 1 x 2.5	2 x 1.5 / 1 x 2.5
	AWG 2 x 16 / 1 x 14	2 x 16 / 1 x 14

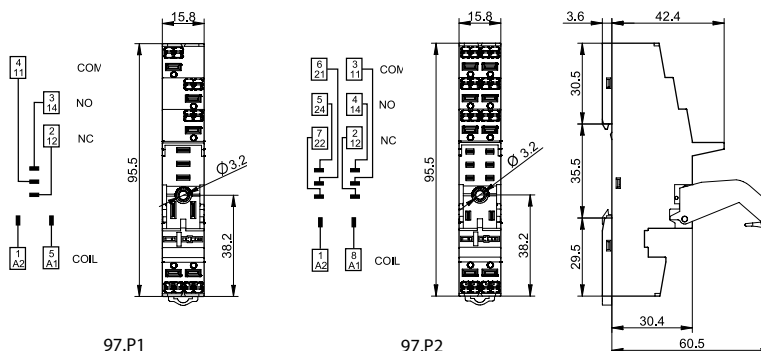

097.58

8-way jumper link for 97.P1 and 97.P2 sockets	097.58
Rated values	10 A - 250 V

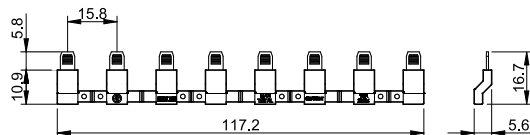

097.52

2-way jumper link for 97.P1 and 97.P2 sockets	097.52
Rated values	10 A - 250 V

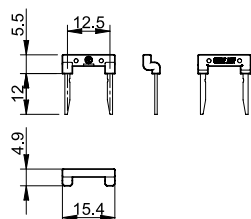



097.42

2-way jumper link for 97.P1 and 97.P2 sockets	097.42
Rated values	10 A - 250 V

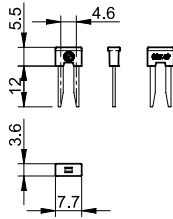

097.00

Marker tag holder for 97.P1 and 97.P2 sockets	097.00
--	--------

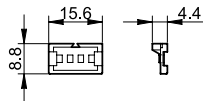

86.30

86 series timer modules	
(12...24)V AC/DC; Bi-function: AI, DI; (0.05 s...100 h)	86.30.0.024.0000
(110...125)V AC; Bi-function: AI, DI; (0.05 s...100 h)	86.30.8.120.0000
(230...240)V AC; Bi-function: AI, DI; (0.05 s...100 h)	86.30.8.240.0000

Approvals (according to type): **CE** **EAC** **cRU** **US**



99.02

99.02 coil indication and EMC suppression modules for 97.P1 and 97.P2 sockets		
Diode (+A1, standard polarity)	(6...220)V DC	99.02.3.000.00
LED	(6...24)V DC/AC	99.02.0.024.59
LED	(28...60)V DC/AC	99.02.0.060.59
LED	(110...240)V DC/AC	99.02.0.230.59
LED + Diode (+A1, standard polarity)	(6...24)V DC	99.02.9.024.99
LED + Diode (+A1, standard polarity)	(28...60)V DC	99.02.9.060.99
LED + Diode (+A1, standard polarity)	(110...220)V DC	99.02.9.220.99
LED + Varistor	(6...24)V DC/AC	99.02.0.024.98
LED + Varistor	(28...60)V DC/AC	99.02.0.060.98
LED + Varistor	(110...240)V DC/AC	99.02.0.230.98
RC circuit	(6...24)V DC/AC	99.02.0.024.09
RC circuit	(28...60)V DC/AC	99.02.0.060.09
RC circuit	(110...240)V DC/AC	99.02.0.230.09
Residual current by-pass	(110...240)V AC	99.02.8.230.07

Approvals
(according to type):



DC Modules with
non-standard polarity
(+A2) on request.

A

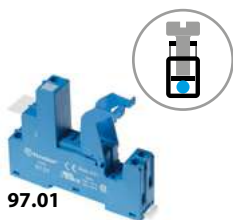

97.01

Approvals
(according to type):



097.01

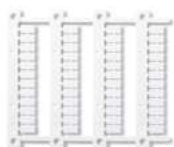

060.48

Screw terminal socket panel or 35 mm rail (EN 60715) mount	97.01 (blue)	97.01.0 (black)	97.02 (blue)	97.02.0 (black)
For relay type	46.61		46.52	
Accessories				
Plastic retaining and release clip (supplied with socket - packaging code SPA)			097.01	
Metal retaining clip			097.71	
Marker tag holder			097.00	
Identification tag			095.00.4	
8-way jumper link	095.18 (blue)		095.18.0 (black)	
Modules (see table below)			99.02	
Timer modules (see table below)			86.30	
Sheet of marker tags for marker tag holder 097.00, 48 tags, 6 x 12 mm, for CEMBRE thermal transfer printers			060.48	
Technical data				
Rated values	16 A-250 V AC		8 A-250 V AC	
Dielectric strength	6 kV (1.2/50 μs) between coil and contacts			
Protection category	IP 20			
Ambient temperature	°C -40...+70 (see diagram L97)			
Screw torque	Nm 0.8			
Wire strip length	mm 8			
Max. wire size for 97.01 and 97.02 socket	solid wire		stranded wire	
	mm ²	1 x 6 / 2 x 2.5		1 x 4 / 2 x 2.5
	AWG	1 x 10 / 2 x 14		1 x 12 / 2 x 14

L 97 - Rated current v ambient temperature
(for 46.61 relay/97.01 socket combination)

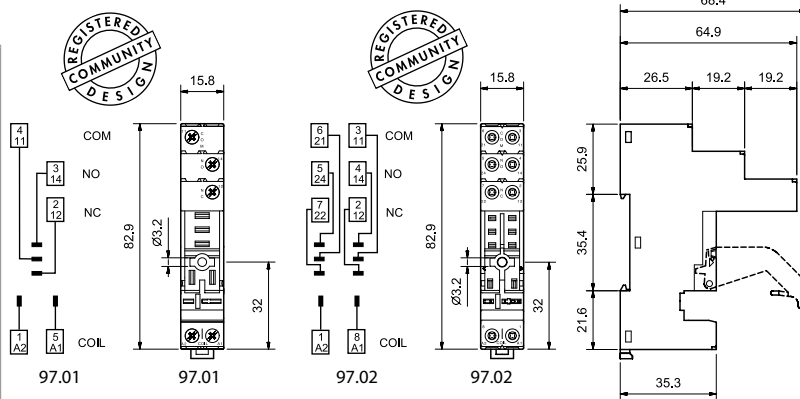
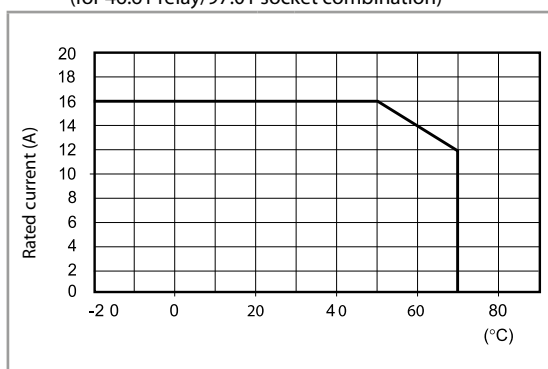

095.18

8-way jumper link for 97.01 and 97.02 sockets	095.18 (blue)	095.18.0 (black)
Rated values	10 A - 250 V	

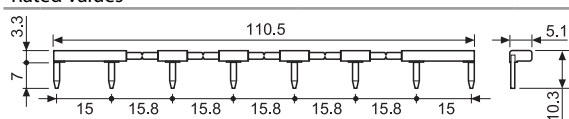

86.30

86 series timer modules	
(12...24)V AC/DC; Bi-function: AI, DI; (0.05 s...100 h)	86.30.0.024.0000
(110...125)V AC; Bi-function: AI, DI; (0.05 s...100 h)	86.30.8.120.0000
(230...240)V AC; Bi-function: AI, DI; (0.05 s...100 h)	86.30.8.240.0000

Approvals (according to type):



99.02

Approvals
(according to type):



DC Modules with
non-standard polarity
(+A2) on request.

99.02 coil indication and EMC suppression modules for 97.01 and 97.02 sockets				
Diode (+A1, standard polarity)	(6...220)V DC	99.02.3.000.00		
LED	(6...24)V DC/AC	99.02.0.024.59		
LED	(28...60)V DC/AC	99.02.0.060.59		
LED	(110...240)V DC/AC	99.02.0.230.59		
LED + Diode (+A1, standard polarity)	(6...24)V DC	99.02.9.024.99		
LED + Diode (+A1, standard polarity)	(28...60)V DC	99.02.9.060.99		
LED + Diode (+A1, standard polarity)	(110...220)V DC	99.02.9.220.99		
LED + Varistor	(6...24)V DC/AC	99.02.0.024.98		
LED + Varistor	(28...60)V DC/AC	99.02.0.060.98		
LED + Varistor	(110...240)V DC/AC	99.02.0.230.98		
RC circuit	(6...24)V DC/AC	99.02.0.024.09		
RC circuit	(28...60)V DC/AC	99.02.0.060.09		
RC circuit	(110...240)V DC/AC	99.02.0.230.09		
Residual current by-pass	(110...240)V AC	99.02.8.230.07		

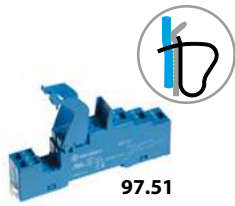

97.51

Approvals
(according to type):



097.01

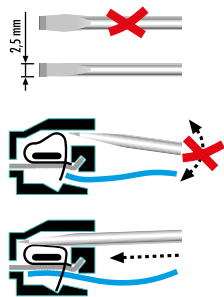

Screwless terminal socket panel or 35 mm rail (EN 60715) mount	97.51 (blue)	97.51.0 (black)	97.52 (blue)	97.52.0 (black)
For relay type	46.61		46.52	
Accessories				
Plastic retaining and release clip (supplied with socket - packaging code SPA)			097.01	
Metal retaining clip			097.71	
Modules (see table below)			99.02	
Timer modules (see table below)			86.30	
Technical data				
Rated values	10 A - 250 V AC		8 A - 250 V AC	
Dielectric strength	6 kV (1.2/50 μs) between coil and contacts			
Protection category	IP 20			
Ambient temperature	°C -25...+70			
Wire strip length	mm 8			
Max. wire size for 97.51 and 97.52 sockets	solid wire		stranded wire	
	mm ² 2 x (0.5...1.5)		2 x (0.5...1.5)	
	AWG 2 x (21...18)		2 x (21...18)	

A

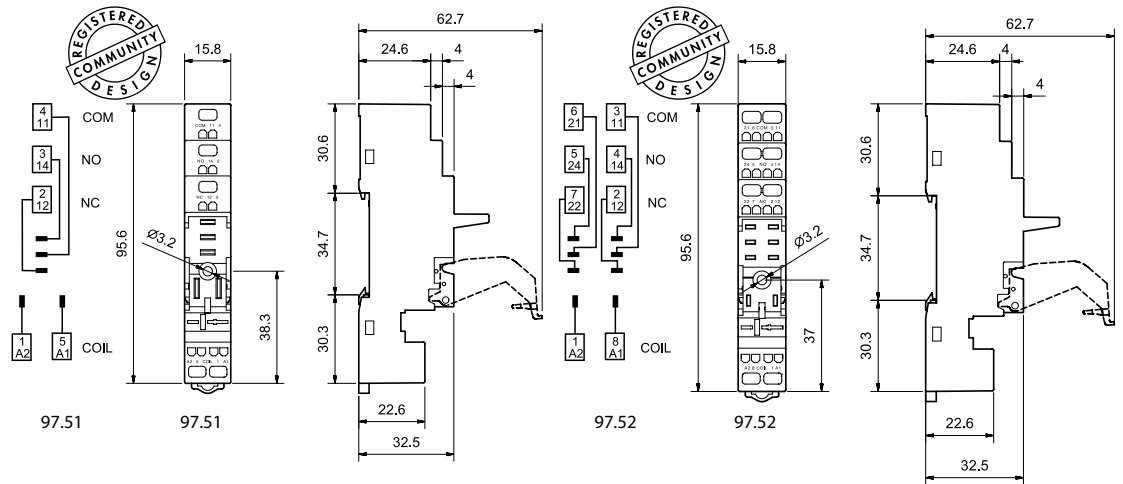

86.30

86 series timer modules	
(12...24)V AC/DC; Bi-function: AI, DI; (0.05 s...100 h)	86.30.0.024.0000
(110...125)V AC; Bi-function: AI, DI; (0.05 s...100 h)	86.30.8.120.0000
(230...240)V AC; Bi-function: AI, DI; (0.05 s...100 h)	86.30.8.240.0000

Approvals (according to type):



99.02

Approvals
(according to type):



DC Modules with non-standard polarity (+A2) on request.

99.02 coil indication and EMC suppression modules for 97.51 and 97.52 sockets		
Diode (+A1, standard polarity)	(6...220)V DC	99.02.3.000.00
LED	(6...24)V DC/AC	99.02.0.024.59
LED	(28...60)V DC/AC	99.02.0.060.59
LED	(110...240)V DC/AC	99.02.0.230.59
LED + Diode (+A1, standard polarity)	(6...24)V DC	99.02.9.024.99
LED + Diode (+A1, standard polarity)	(28...60)V DC	99.02.9.060.99
LED + Diode (+A1, standard polarity)	(110...220)V DC	99.02.9.220.99
LED + Varistor	(6...24)V DC/AC	99.02.0.024.98
LED + Varistor	(28...60)V DC/AC	99.02.0.060.98
LED + Varistor	(110...240)V DC/AC	99.02.0.230.98
RC circuit	(6...24)V DC/AC	99.02.0.024.09
RC circuit	(28...60)V DC/AC	99.02.0.060.09
RC circuit	(110...240)V DC/AC	99.02.0.230.09
Residual current by-pass	(110...240)V AC	99.02.8.230.07

A



97.11

Approvals
(according to type):
EAC c US



97.12

Approvals
(according to type):
EAC c US

PCB socket	97.11 (blue)	97.12 (blue)
For relay type	46.61	46.52
Technical data		
Rated values	12 A - 250 V (see diagram L97)	8 A - 250 V
Dielectric strength	6 kV (1.2/50 μs) between coil and contacts	
Protection category	IP 20	
Ambient temperature	°C -40...+70	

L 97 - Rated current v ambient temperature
(for 46.61 relay/97.11 socket combination)

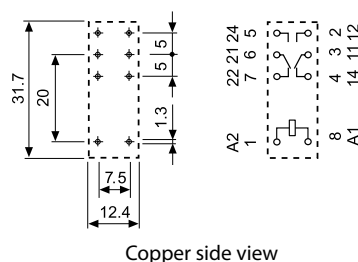
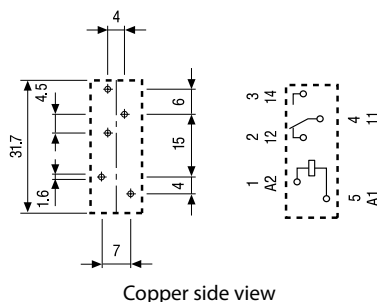
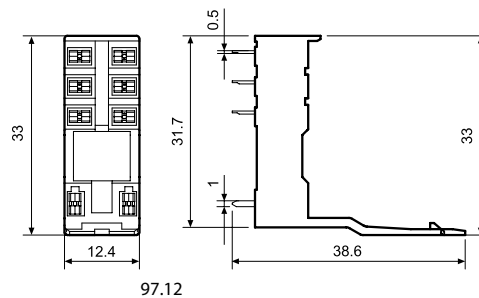
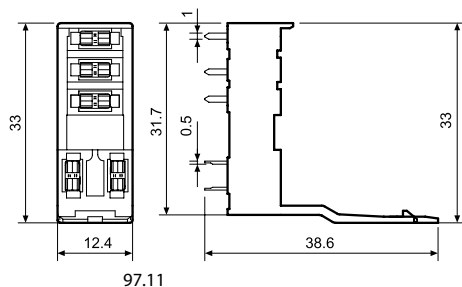
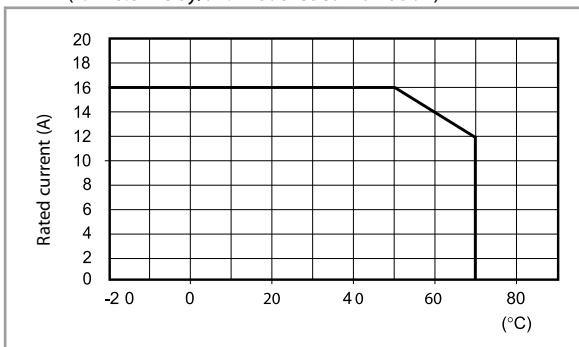

Packaging codes

How to code and identify retaining clip and packaging options for sockets.

Example:

9 7 . P 1 S P A

A Standard packaging

SM Metal retaining clip
SL Plastic retaining clip



finder[®]
SWITCH TO THE FUTURE

55
SERIES

General purpose relays 7 - 10 A



Automation for
blinds, grilles
and shutters



Control and
management of
electric power



Shipyards



Road / tunnel
lighting



Hoists and
cranes



Circuit breakers
and switches



Control panels



Panels for electrical
distribution

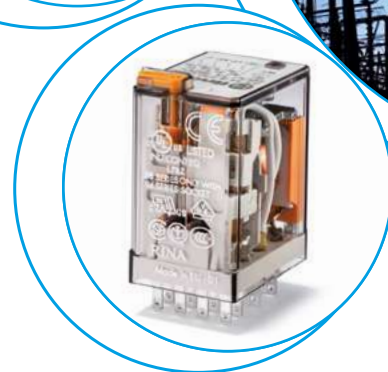

General purpose relays
For printed circuit mounting

Type 55.12

- 2 CO 10 A

Type 55.13

- 3 CO 10 A

Type 55.14

- 4 CO 7 A

- AC & DC coils
- Cadmium Free contacts
- Contact material options
- RT III (wash tight) option available

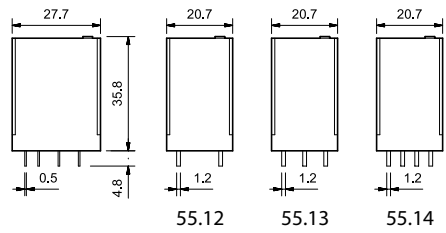

FOR UL RATINGS SEE:
"General technical information" page V

Contact specification

Contact configuration		2 CO (DPDT)	3 CO (3PDT)	4 CO (4PDT)
Rated current/Maximum peak current	A	10/20	10/20	7/15
Rated voltage/ Maximum switching voltage	V AC	250/400	250/400	250/250
Rated load AC1	VA	2500	2500	1750
Rated load AC15 (230 V AC)	VA	500	500	350
Single phase motor rating (230 V AC)	kW	0.37	0.37	0.125
Breaking capacity DC1: 30/110/220 V	A	10/0.25/0.12	10/0.25/0.12	7/0.25/0.12
Minimum switching load	mW (V/mA)	300 (5/5)	300 (5/5)	300 (5/5)
Standard contact material		AgNi	AgNi	AgNi

Coil specification

Nominal voltage (U _N)	V AC (50/60 Hz)	6 - 12 - 24 - 48 - 60 - 110 - 120 - 230 - 240		
	V DC	6 - 12 - 24 - 48 - 60 - 110 - 125 - 220		
Rated power AC/DC	VA (50 Hz)/W	1.5/1	1.5/1	1.5/1
Operating range	AC	(0.8...1.1)U _N		
	DC	(0.8...1.1)U _N		
Holding voltage	AC/DC	0.8 U _N / 0.5 U _N		
Must drop-out voltage	AC/DC	0.2 U _N / 0.1 U _N		

Technical data

Mechanical life AC/DC	cycles	20 · 10 ⁶ / 50 · 10 ⁶	20 · 10 ⁶ / 50 · 10 ⁶	20 · 10 ⁶ / 50 · 10 ⁶
Electrical life at rated load AC1	cycles	200 · 10 ³	200 · 10 ³	150 · 10 ³
Operate/release time	ms	10/5	10/5	11/3
Insulation between coil and contacts (1.2/50 μs)	kV	4	4	4
Dielectric strength between open contacts	V AC	1000	1000	1000
Ambient temperature range	°C	-40...+85	-40...+85	-40...+85
Environmental protection		RT I	RT I	RT I

Approvals (according to type)



**General purpose relays
For socket mounting**

Type 55.32

- 2 CO 10 A

Type 55.33

- 3 CO 10 A

Type 55.34

- 4 CO 7 A

- AC & DC coils
- Lockable test button and mechanical flag indicator as standard on 2 & 4 pole types
- Integral LED and coil suppression options
- 94 series sockets for PCB or 35 mm rail mounting (EN 60715) with Screw, Screwless or Push-in terminals
- Coil Indication and EMC suppression modules 99 series and Timer module 86.30 options
- Optional alternative mounting adaptors
- UL Listing (certain relay/socket combinations)
- Cadmium Free contacts
- Contact material options
- European Patent

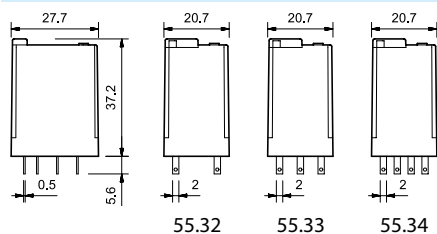

FOR UL RATINGS SEE:

"General technical information" page V

	55.32	55.33	55.34
	<ul style="list-style-type: none"> • 2 CO 10 A • Plug-in 94 series sockets 	<ul style="list-style-type: none"> • 3 CO 10 A • Plug-in 94 series sockets 	<ul style="list-style-type: none"> • 4 CO 7 A • Plug-in 94 series sockets
Contact specification			
Contact configuration	2 CO (DPDT)	3 CO (3PDT)	4 CO (4PDT)
Rated current/Maximum peak current	A 10/20	10/20	7/15
Rated voltage/ Maximum switching voltage	V AC 250/400	250/400	250/250
Rated load AC1	VA 2500	2500	1750
Rated load AC15 (230 V AC)	VA 500	500	350
Single phase motor rating (230 V AC)	kW 0.37	0.37	0.125
Breaking capacity DC1: 30/110/220 V	A 10/0.25/0.12	10/0.25/0.12	7/0.25/0.12
Minimum switching load	mW (V/mA) 300 (5/5)	300 (5/5)	300 (5/5)
Standard contact material	AgNi	AgNi	AgNi
Coil specification			
Nominal voltage (U _N)	V AC (50/60 Hz)	6 - 12 - 24 - 48 - 60 - 110 - 120 - 230 - 240	
	V DC	6 - 12 - 24 - 48 - 60 - 110 - 125 - 220	
Rated power AC/DC	VA (50 Hz)/W	1.5/1	1.5/1
Operating range	AC	(0.8...1.1)U _N	(0.8...1.1)U _N
	DC	(0.8...1.1)U _N	(0.8...1.1)U _N
Holding voltage	AC/DC	0.8 U _N / 0.5 U _N	0.8 U _N / 0.5 U _N
Must drop-out voltage	AC/DC	0.2 U _N / 0.1 U _N	0.2 U _N / 0.1 U _N
Technical data			
Mechanical life AC/DC	cycles	20 · 10 ⁶ / 50 · 10 ⁶	20 · 10 ⁶ / 50 · 10 ⁶
Electrical life at rated load AC1	cycles	200 · 10 ³	150 · 10 ³
Operate/release time	ms	10/5	11/3
Insulation between coil and contacts (1.2/50 μs)	kV	4	4
Dielectric strength between open contacts	V AC	1000	1000
Ambient temperature range	°C	-40...+85	-40...+85
Environmental protection		RT I	RT I
Approvals (according to type)			

Ordering information

Example: 55 series plug-in relay, 4 CO, 12 V DC coil, lockable test button and mechanical indicator.

5 5 . 3 4 . 9 . 0 1 2 . 0 0 4 0

Series ————

Type
1 = PCB
3 = Plug-in

No. of poles
2 = 2 pole, 10 A
3 = 3 pole, 10 A
4 = 4 pole, 7 A

Coil version
8 = AC (50/60 Hz)
9 = DC

Coil voltage
See coil specifications

A: Contact material
0 = Standard AgNi
5 = AgNi + Au

B: Contact circuit
0 = CO (nPDT)

D: Special versions
0 = Standard
1 = Wash tight (RT III)
for 55.12, 55.13 and 55.14 only

C: Options
0 = None
1 = Lockable test button
2 = Mechanical indicator
3 = LED (AC)
4 = Lockable test button +
mechanical indicator
5 = Lockable test button + LED (AC)
54 = Lockable test button + LED (AC) +
mechanical indicator
6* = Double LED (DC non-polarized)
7* = Lockable test button + double
LED (DC non-polarized)
74* = Lockable test button + double
LED (DC non-polarized) +
mechanical indicator
8* = LED + diode (DC, polarity positive
to pin A1/13)
9* = Lockable test button + LED +
diode (DC, polarity positive to pin
A1/13)
94* = Lockable test button + LED +
diode (DC, polarity positive to pin
A1/13) + mechanical indicator
* Options not available for 220 V DC
versions.

Selecting features and options: only combinations in the same row are possible.

Preferred selections for best availability are shown in **bold**.

Type	Coil version	A	B	C	D
55.32/34	AC - DC	0 - 5	0	0	0
	AC	0 - 5	0	2 - 3 - 4 - 5	0
	AC	0 - 5	0	54	/
	DC	0 - 5	0	2 - 4 - 6 - 7 - 8 - 9	0
	DC	0 - 5	0	74 - 94	/
55.33	AC - DC	0 - 5	0	0	0
	AC	0 - 5	0	1 - 3 - 5	0
	DC	0 - 5	0	1 - 6 - 7 - 8 - 9	0
55.12/13/14	AC - DC	0 - 5	0	0	0 - 1

Descriptions: options and special versions

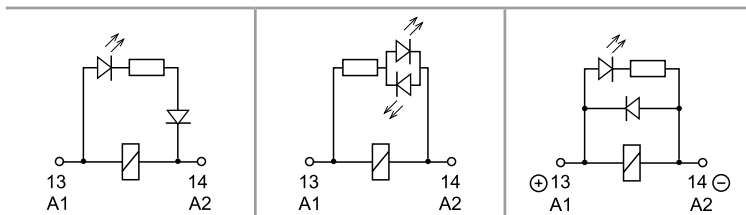

C: Option 3, 5, 54
LED (AC)

C: Option 6, 7, 74
Double LED
(DC non-polarized)

C: Option 8, 9, 94
LED + diode (DC, polarity
positive to pin A1/13)

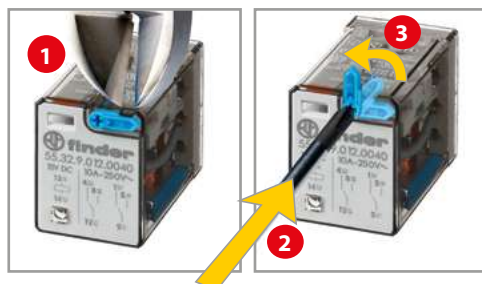

Lockable test button and mechanical flag indicator
(0010, 0040, 0050, 0054, 0070, 0074, 0090, 0094)



The dual-purpose Finder test button can be used in two ways:

Case 1) The plastic pip (located directly above the test button) remains intact. In this case, when the test button is pushed, the contacts operate. When the test button is released the contacts return to their former state.

Case 2) The plastic pip is broken-off (using an appropriate cutting tool). In this case, (in addition to the above function), when the test button is pushed and rotated, the contacts are latched in the operating state, and remain so until the test button is rotated back to its former position.

In both cases ensure that the test button actuation is swift and decisive.

Technical data

Insulation according to EN 61810-1		2 pole - 3 pole	4 pole
Nominal voltage of supply system	V AC	230/400	230
Rated insulation voltage	V AC	400	250
Pollution degree		2	2
Insulation between coil and contact set			
Type of Insulation		Basic	Basic
Overvoltage category		III	III
Rated impulse voltage	kV (1.2/50 μs)	4	4
Dielectric strength	V AC	2000	2000
Insulation between adjacent contacts			
Type of insulation		Basic	Basic
Overvoltage category		III	II
Rated impulse voltage	kV (1.2/50 μs)	4	2.5
Dielectric strength	V AC	2000	2000
Insulation between open contacts			
Type of disconnection		Micro-disconnection	Micro-disconnection
Dielectric strength	V AC/kV (1.2/50 μs)	1000/1.5	1000/1.5
Conducted disturbance immunity			
Burst (5...50)ns, 5 kHz, on A1 - A2 according to EN 61000-4-4		level 4 (4 kV)	
Surge (1.2/50 μs) on A1 - A2 (differential mode) according to EN 61000-4-5		level 4 (4 kV)	
Other data			
Bounce time: NO/NC	ms	1/3	
Vibration resistance (5...55)Hz: NO/NC	g	15/15	
Shock resistance	g	16	
Power lost to the environment	without contact current	W 1	
	with rated current	W 3 (2 pole)	W 4 (3 pole)
Recommended distance between relays mounted on PCB	mm	≥ 5	

Contact specification

F 55 - Electrical life (AC) v contact current
2 and 3 pole relays

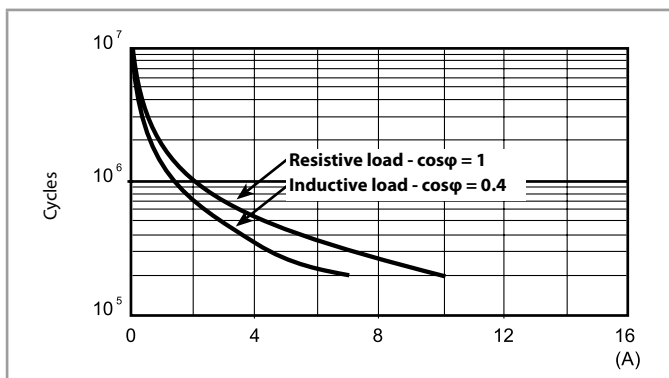

F 55 - Electrical life (AC) v contact current
4 pole relays

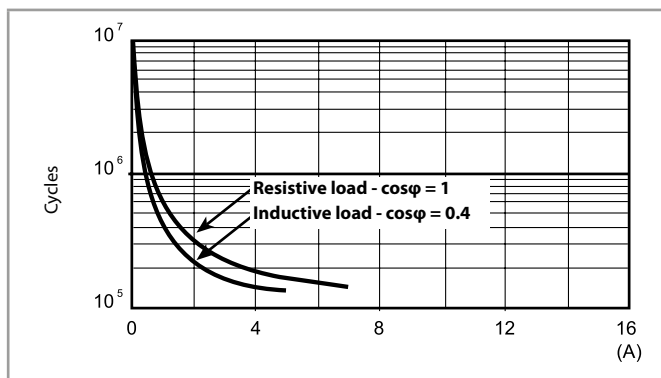

H 55 - Maximum DC1 breaking capacity

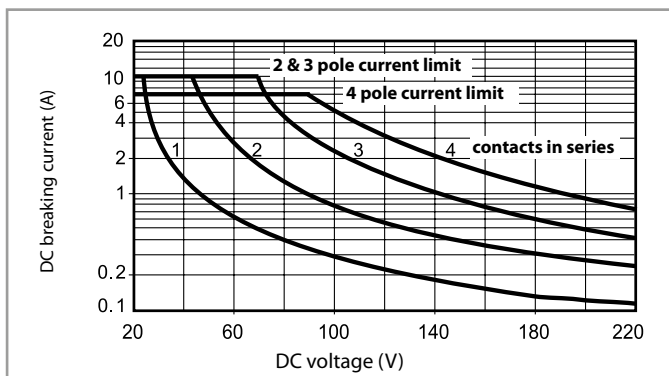

- When switching a resistive load (DC1) having voltage and current values under the curve, an electrical life of $\geq 100 \cdot 10^3$ can be expected.
- In the case of DC13 loads, the connection of a diode in parallel with the load will permit a similar electrical life as for a DC1 load.
Note: the release time of the load will be increased.

Coil specifications

DC coil data

Nominal voltage U_N V	Coil code	Operating range		Resistance R Ω	Rated coil consumption I at U_N mA
		U_{min} V	U_{max} V		
6	9.006	4.8	6.6	40	150
12	9.012	9.6	13.2	140	86
24	9.024	19.2	26.4	600	40
48	9.048	38.4	52.8	2400	20
60	9.060	48	66	4000	15
110	9.110	88	121	12500	8.8
125	9.125	100	138	17300	7.2
220	9.220	176	242	54000	4

AC coil data

Nominal voltage U_N V	Coil code	Operating range		Resistance R Ω	Rated coil consumption I at U_N mA
		U_{min} V	U_{max} V		
6	8.006	4.8	6.6	12	200
12	8.012	9.6	13.2	50	97
24	8.024	19.2	26.4	190	53
48	8.048	38.4	52.8	770	25
60	8.060	48	66	1200	21
110	8.110	88	121	3940	12.5
120	8.120	96	132	4700	12
230	8.230	184	253	17000	6
240	8.240	192	264	19100	5.3

R 55 - DC coil operating range v ambient temperature

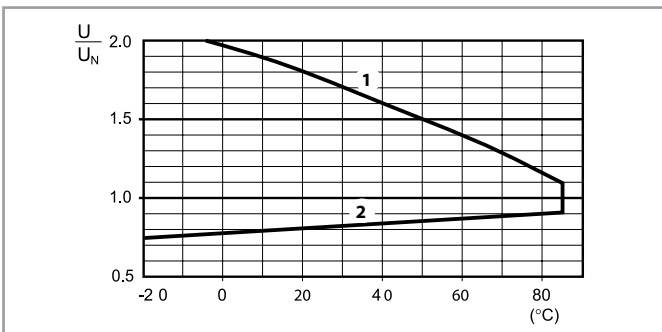

1 - Max. permitted coil voltage.
2 - Min. pick-up voltage with coil at ambient temperature.

R 55 - AC coil operating range v ambient temperature

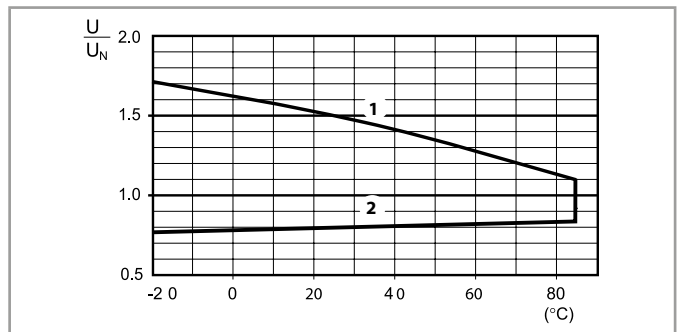

1 - Max. permitted coil voltage.
2 - Min. pick-up voltage with coil at ambient temperature.

Accessories



056.25

056.25 with relay

Top flange mount adaptor for 55.32, 55.33, 55.34

056.25

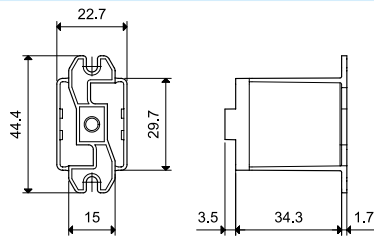

056.25

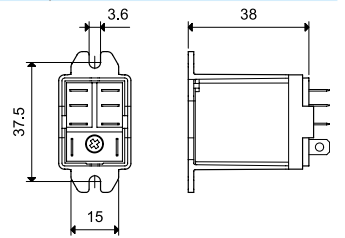

056.25 with relay



056.26

056.26 with relay

Rear flange mount adaptor for 55.32, 55.33, 55.34

056.26

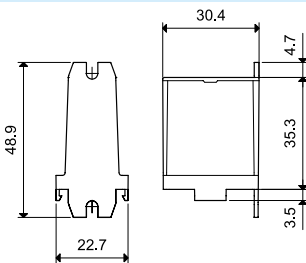

056.26

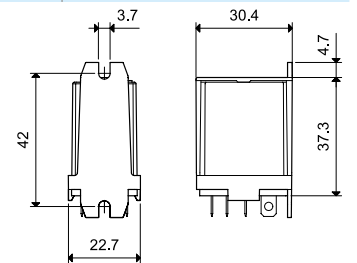

056.26 with relay



056.27

056.27 with relay

Top 35 mm rail (EN 60715) adaptor for 55.32, 55.33, 55.34

056.27

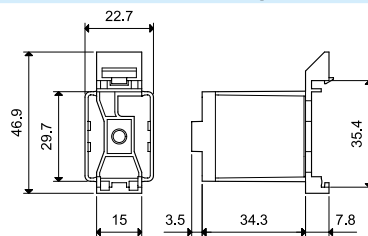

056.27

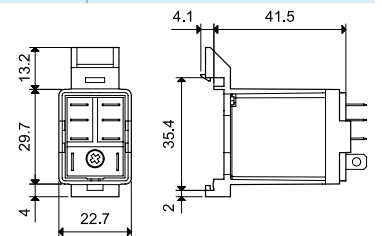

056.27 with relay

A

NEW

94.P4
See page 9



Module	Socket	Relay	Description	Mounting	Accessories
99.02	94.P3	55.33	Push-in terminal socket - For fast cable connections - Top terminals - Contacts - Bottom terminals - Coil	Panel or 35 mm rail (EN 60715) mount	- Coil indication and EMC suppression modules - Jumper link - Timer modules - Plastic retaining and release clip
	94.P4	55.32 55.34			

94.04
See page 11



Module	Socket	Relay	Description	Mounting	Accessories
99.02	94.02	55.32	Screw terminal (Box clamp) socket - Top terminals - Contacts - Bottom terminals - Coil	Panel or 35 mm rail (EN 60715) mount	- Coil indication and EMC suppression modules - Jumper link - Timer modules - Plastic retaining and release clip
	94.03	55.33			
	94.04	55.32 55.34			

94.54
See page 12



Module	Socket	Relay	Description	Mounting	Accessories
99.02	94.54	55.32 55.34	Screwless terminal socket - Top terminals - Contacts - Bottom terminals - Coil	Panel or 35 mm rail (EN 60715) mount	- Coil indication and EMC suppression modules - Jumper link - Timer modules - Plastic retaining and release clip

94.84.2
See page 13



Module	Socket	Relay	Description	Mounting	Accessories
99.80	94.84.2	55.32 55.34	Screw terminal (Box clamp) socket	Panel or 35 mm rail (EN 60715) mount	- Coil indication and EMC suppression modules - Jumper link - Plastic retaining and release clip

94.94.3
See page 14



Module	Socket	Relay	Description	Mounting	Accessories
99.80	94.92.3	55.32	Screw terminal (Box clamp) socket - Top terminals - Contacts - Bottom terminals - Coil	Panel or 35 mm rail (EN 60715) mount	- Coil indication and EMC suppression modules - Jumper link - Plastic retaining and release clip
	94.94.3	55.32 55.34			

94.74
See page 15



Module	Socket	Relay	Description	Mounting	Accessories
99.01	94.72	55.32	Screw terminal (Plate clamp) socket For 94.82: - 23 mm wide for space saving	Panel or 35 mm rail (EN 60715) mount	- Coil indication and EMC suppression modules - Plastic retaining and release clip
	94.73	55.33			
	94.74	55.32 55.34			
	94.82	55.32			

94.14
See page 16

Module	Socket	Relay	Description	Mounting	Accessories
—	94.12	55.32	PCB socket	PCB mounting	- Metal retaining clip
—	94.13	55.33			
—	94.14	55.32 55.34			

94.22
See page 16

Module	Socket	Relay	Description	Mounting	Accessories
—	94.22	55.32	Panel mount with solder connections	Panel mount on 1 mm thick panel	- Metal retaining clip
—	94.23	55.33			
—	94.24	55.32 55.34			

94.34
See page 17

Module	Socket	Relay	Description	Mounting	Accessories
—	94.32	55.32	Panel mount with solder connections	M3 screw fixing	- Metal retaining clip
—	94.33	55.33			
—	94.34	55.32 55.34			

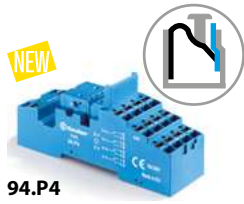

94.P4

Approvals
(according to type):



Certain relay/socket combinations



094.91.3

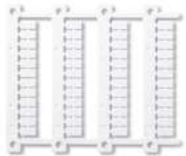

060.48

Push-in terminal socket panel or 35 mm (EN 60715) rail mount		94.P3 Blue	94.P4 Blue
For relay type		55.33	55.32, 55.34
Accessories			
Metal retaining clip			094.71
Plastic retaining and release clip (supplied with socket - packaging code SPA)			094.91.3
6-way jumper link			094.56
Identification tag			095.00.4
2-way jumper link			094.52.1
2-way jumper link			097.52
Marker tag holder			097.00
Modules (see table below)			99.02
Timer modules (see table below)			86.30
Sheet of marker tags for plastic retaining and release clip 094.91.3 and for marker tag holder 097.00, 48 tags, 6 x 12 mm for CEMBRE thermal transfer printers			060.48
Technical data			
Rated values		10 A - 250 V	
Dielectric strength		2 kV AC	
Protection category		IP 20	
Ambient temperature		°C -40...+70	
Wire strip length		mm 8	
Min. wire size for 94.P3 and 94.P4 sockets		solid wire	stranded wire
		mm ² 0.5	0.5
Max. wire size for 94.P3 and 94.P4 sockets		AWG 21	21
		solid wire	stranded wire
		mm ² 2 x 1.5 / 1 x 2.5	2 x 1.5 / 1 x 2.5
		AWG 2 x 16 / 1 x 14	2 x 16 / 1 x 14



094.56



094.52.1

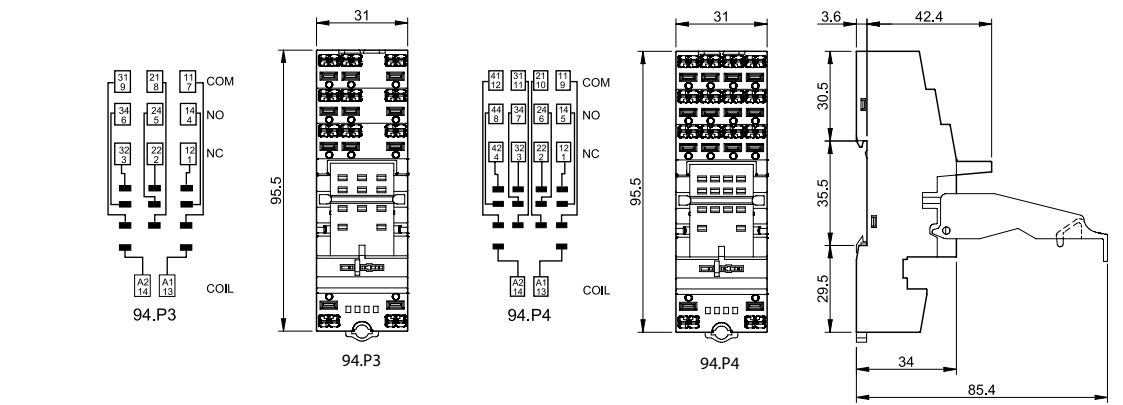

6-way jumper link for 94.P3 and 94.P4 sockets	094.56 (blue)
Rated values	10 A - 250 V

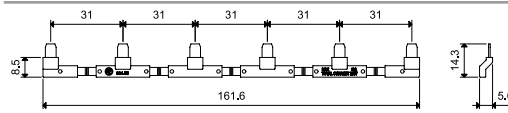

2-way jumper link for 94.P3 and 94.P4 sockets	094.52.1
Rated values	10 A - 250 V

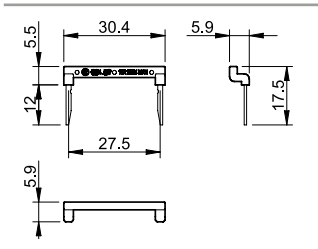

A



097.52

2-way jumper link for 94.P3 and 94.P4 sockets	097.52
Rated values	10 A - 250 V

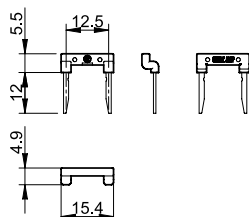



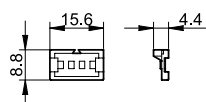

097.00

Marker tag holder for 94.P3 and 94.P4 sockets	097.00
--	--------



86.30

86 series timer modules		
(12...24)V AC/DC; Bi-function: AI, DI; (0.05 s...100 h)	86.30.0.024.0000	
(110...125)V AC; Bi-function: AI, DI; (0.05 s...100 h)	86.30.8.120.0000	
(230...240)V AC; Bi-function: AI, DI; (0.05 s...100 h)	86.30.8.240.0000	

Approvals (according to type):    

99.02

Approvals
(according to type):  DC Modules with
non-standard polarity
(+A2) on request.

99.02 coil indication and EMC suppression modules for 94.P3 and 94.P4 sockets		
Diode (+A1, standard polarity)	(6...220)V DC	99.02.3.000.00
LED	(6...24)V DC/AC	99.02.0.024.59
LED	(28...60)V DC/AC	99.02.0.060.59
LED	(110...240)V DC/AC	99.02.0.230.59
LED + Diode (+A1, standard polarity)	(6...24)V DC	99.02.9.024.99
LED + Diode (+A1, standard polarity)	(28...60)V DC	99.02.9.060.99
LED + Diode (+A1, standard polarity)	(110...220)V DC	99.02.9.220.99
LED + Varistor	(6...24)V DC/AC	99.02.0.024.98
LED + Varistor	(28...60)V DC/AC	99.02.0.060.98
LED + Varistor	(110...240)V DC/AC	99.02.0.230.98
RC circuit	(6...24)V DC/AC	99.02.0.024.09
RC circuit	(28...60)V DC/AC	99.02.0.060.09
RC circuit	(110...240)V DC/AC	99.02.0.230.09
Residual current by-pass	(110...240)V AC	99.02.8.230.07



94.04

Approvals
(according to type):



cUL US Certain relay/socket combinations



94.91.3

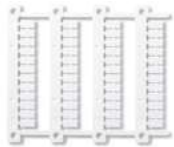

060.48

Screw terminal (Box clamp) socket panel or 35 mm (EN 60715) rail mount	94.02 Blue	94.02.0 Black	94.03 Blue	94.03.0 Black	94.04 Blue	94.04.0 Black
For relay type	55.32		55.33		55.32, 55.34	
Accessories						
Metal retaining clip	094.71					
Plastic retaining and release clip (supplied with socket - packaging code SPA)	094.91.3	094.91.30	094.91.3	094.91.30	094.91.3	094.91.30
6-way jumper link	094.06	094.06.0	094.06	094.06.0	094.06	094.06.0
Identification tag	094.00.4					
Marker tag holder	097.00					
Modules (see table below)	99.02					
Timer modules (see table below)	86.30					
Sheet of marker tags for plastic retaining and release clip 094.91.3 and for marker tag holder 097.00, 48 tags, 6 x 12 mm for CEMBRE thermal transfer printers	060.48					
Technical data						
Rated values	10 A - 250 V					
Dielectric strength	2 kV AC					
Protection category	IP 20					
Ambient temperature	°C -40...+70					
⊕ Screw torque	Nm 0.5					
Wire strip length	mm 8					
Max. wire size for 94.02/03/04 sockets	solid wire			stranded wire		
	mm ² 1 x 6 / 2 x 2.5			1 x 4 / 2 x 2.5		
	AWG 1 x 10 / 2 x 14			1 x 12 / 2 x 14		

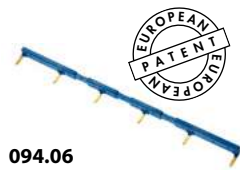
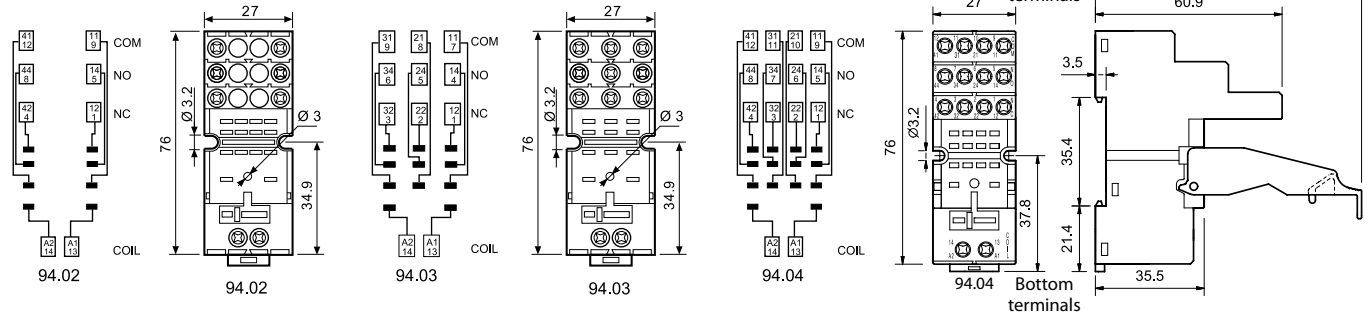

094.06

6-way jumper link for 94.02, 94.03 and 94.04 sockets	094.06 (blue)	094.06.0 (black)
Rated values	10 A - 250 V	

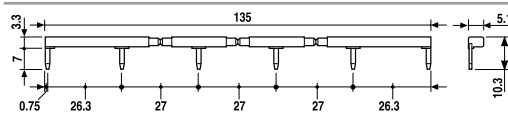

86.30

86 series timer modules	
(12...24)V AC/DC; Bi-function: AI, DI; (0.05 s...100 h)	86.30.0.024.0000
(110...125)V AC; Bi-function: AI, DI; (0.05 s...100 h)	86.30.8.120.0000
(230...240)V AC; Bi-function: AI, DI; (0.05 s...100 h)	86.30.8.240.0000

Approvals (according to type): **CE EAC cRU US**



99.02

Approvals
(according to type):



DC Modules with non-standard polarity (+A2) on request.

99.02 coil indication and EMC suppression modules for 94.02, 94.03 and 94.04 sockets		
Diode (+A1, standard polarity)	(6...220)V DC	99.02.3.000.00
LED	(6...24)V DC/AC	99.02.0.024.59
LED	(28...60)V DC/AC	99.02.0.060.59
LED	(110...240)V DC/AC	99.02.0.230.59
LED + Diode (+A1, standard polarity)	(6...24)V DC	99.02.9.024.99
LED + Diode (+A1, standard polarity)	(28...60)V DC	99.02.9.060.99
LED + Diode (+A1, standard polarity)	(110...240)V DC	99.02.9.220.99
LED + Varistor	(6...24)V DC/AC	99.02.0.024.98
LED + Varistor	(28...60)V DC/AC	99.02.0.060.98
LED + Varistor	(110...240)V DC/AC	99.02.0.230.98
RC circuit	(6...24)V DC/AC	99.02.0.024.09
RC circuit	(28...60)V DC/AC	99.02.0.060.09
RC circuit	(110...240)V DC/AC	99.02.0.230.09
Residual current by-pass	(110...240)V AC	99.02.8.230.07

A



94.54

Approvals
(according to type):



094.91.3

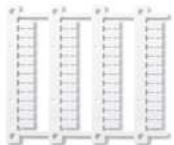

060.48

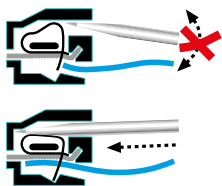
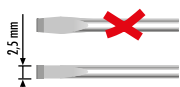

Screwless terminal socket 35 mm rail (EN 60715) mount		94.54 (blue)
For relay type		55.32, 55.34
Accessories		
Metal retaining clip		094.71
Plastic retaining and release clip		094.91.3
6-way jumper link		094.56
Modules (see table below)		99.02, 86.30
Sheet of marker tags for retaining and release clip 094.91.3, plastic, 48 tags, 6 x 12 mm for CEMBRE thermal transfer printers		060.48
Technical data		
Rated values		10 A - 250 V
Dielectric strength		2 kV AC
Protection category		IP 20
Ambient temperature		°C -25...+70
Wire strip length		mm 10
Max. wire size for 94.54 sockets		solid wire
		stranded wire
		mm ² 2 x (0.5...1.5) 2 x (0.5...1.5)
AWG		2 x (21...14) 2 x (21...14)

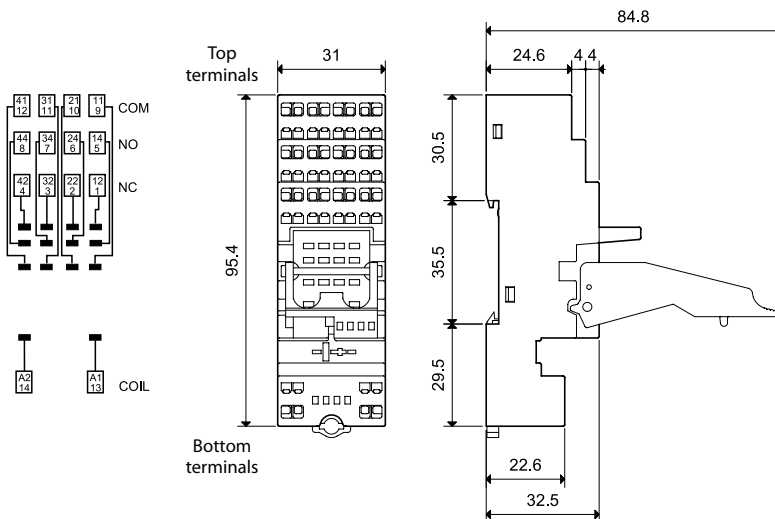

Sockets + jumper link

6-way jumper link	094.56 (blue)
Rated values	10 A - 250 V

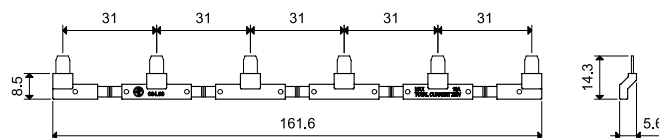

094.56



86 series timer modules	
(12...24)V AC/DC; Bi-function: AI, DI; (0.05 s...100 h)	86.30.0.024.0000
(110...125)V AC; Bi-function: AI, DI; (0.05 s...100 h)	86.30.8.120.0000
(230...240)V AC; Bi-function: AI, DI; (0.05 s...100 h)	86.30.8.240.0000



86.30

Approvals (according to type):

99.02 coil indication and EMC suppression modules for 94.54 sockets		
Diode (+A1, standard polarity)	(6...220)V DC	99.02.3.000.00
LED	(6...24)V DC/AC	99.02.0.024.59
LED	(28...60)V DC/AC	99.02.0.060.59
LED	(110...240)V DC/AC	99.02.0.230.59
LED + Diode (+A1, standard polarity)	(6...24)V DC	99.02.9.024.99
LED + Diode (+A1, standard polarity)	(28...60)V DC	99.02.9.060.99
LED + Diode (+A1, standard polarity)	(110...220)V DC	99.02.9.220.99
LED + Varistor	(6...24)V DC/AC	99.02.0.024.98
LED + Varistor	(28...60)V DC/AC	99.02.0.060.98
LED + Varistor	(110...240)V DC/AC	99.02.0.230.98
RC circuit	(6...24)V DC/AC	99.02.0.024.09
RC circuit	(28...60)V DC/AC	99.02.0.060.09
RC circuit	(110...240)V DC/AC	99.02.0.230.09
Residual current by-pass	(110...240)V AC	99.02.8.230.07



99.02

Approvals
(according to type):



DC Modules with
non-standard polarity
(+A2) on request.

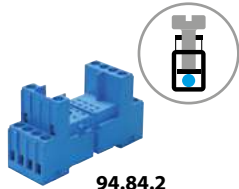

94.84.2

Approvals
(according to type):



094.91.3

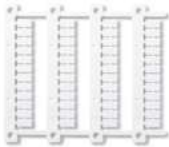

060.48

Screw terminal (Box clamp) socket panel or 35 mm (EN 60715) rail mount	94.84.2	94.84.20
For relay type	55.32, 55.34	
Accessories		
Metal retaining clip (supplied with socket - packaging code SMA)		094.71
Plastic retaining and release clip	094.91.3	094.91.30
6-way jumper link	094.06	094.06.0
Identification tag		094.80.3
Modules (see table below)		99.80
Sheet of marker tags for retaining and release clip 094.91.3, plastic, 48 tags, 6 x 12 mm for CEMBRE thermal transfer printers		060.48
Technical data		
Rated values	10 A - 250 V	
Dielectric strength	2 kV AC	
Protection category	IP 20	
Ambient temperature	°C -40...+70	
Screw torque	Nm	0.5
Wire strip length	mm	7
Max. wire size for 94.84.2 socket	mm ²	solid wire 1 x 6 / 2 x 2.5
		stranded wire 1 x 4 / 2 x 2.5
	AWG	1 x 10 / 2 x 14

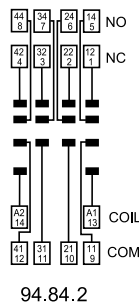

94.84.2

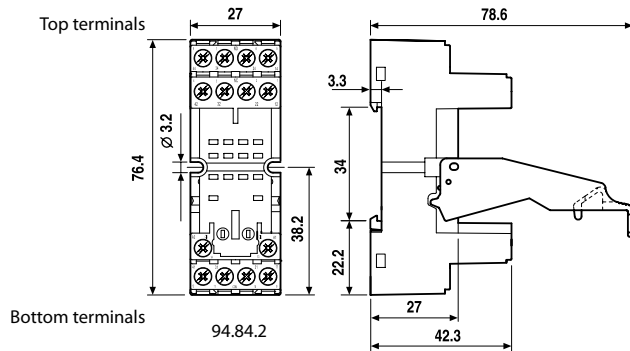

Bottom terminals

94.84.2

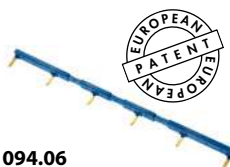

094.06



6-way jumper link for 94.84.2 socket	094.06 (blue)	094.06.0 (black)
Rated values	10 A - 250 V	

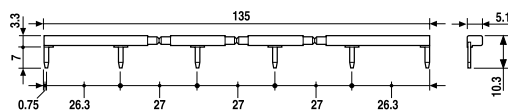

99.80 coil indication and EMC suppression modules for 94.84.2 socket		Blue*
Diode (+A1, standard polarity)	(6...220)V DC	99.80.3.000.00
LED	(6...24)V DC/AC	99.80.0.024.59
LED	(28...60)V DC/AC	99.80.0.060.59
LED	(110...240)V DC/AC	99.80.0.230.59
LED + Diode (+A1, standard polarity)	(6...24)V DC	99.80.9.024.99
LED + Diode (+A1, standard polarity)	(28...60)V DC	99.80.9.060.99
LED + Diode (+A1, standard polarity)	(110...220)V DC	99.80.9.220.99
LED + Varistor	(6...24)V DC/AC	99.80.0.024.98
LED + Varistor	(28...60)V DC/AC	99.80.0.060.98
LED + Varistor	(110...240)V DC/AC	99.80.0.230.98
RC circuit	(6...24)V DC/AC	99.80.0.024.09
RC circuit	(28...60)V DC/AC	99.80.0.060.09
RC circuit	(110...240)V DC/AC	99.80.0.230.09
Residual current by-pass	(110...240)V AC	99.80.8.230.07



99.80

Approvals
(according to type):



* Modules in Black housing are available on request.

Green LED is standard.
Red LED available on request.

A



94.94.3

Approvals
(according to type):



094.91.3

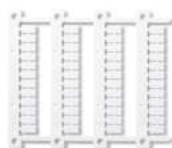

060.48

Screw terminal (Box clamp) socket panel or 35 mm rail mount	94.92.3 (blue)	94.92.30 (black)	94.94.3 (blue)	94.94.30 (black)
For relay type	55.32		55.32, 55.34	
Accessories				
Metal retaining clip	094.71			
Plastic retaining and release clip	094.91.3	094.91.30	094.91.3	094.91.30
6-way jumper link	094.06	094.06.0	094.06	094.06.0
Identification tag	094.80.3			
Modules (see table below)	99.80			
Sheet of marker tags for retaining and release clip 094.91.3, plastic, 48 tags, 6 x 12 mm for CEMBRE thermal transfer printers	060.48			
Technical data				
Rated values	10 A - 250 V			
Dielectric strength	2 kV AC			
Protection category	IP 20			
Ambient temperature	°C -25...+70			
Screw torque	Nm 0.5			
Wire strip length	mm 8			
Max. wire size for 94.92.3 and 94.94.3 sockets	solid wire		stranded wire	
	mm ² 1 x 6 / 2 x 2.5		1 x 4 / 2 x 2.5	
	AWG 1 x 10 / 2 x 14		1 x 12 / 2 x 14	

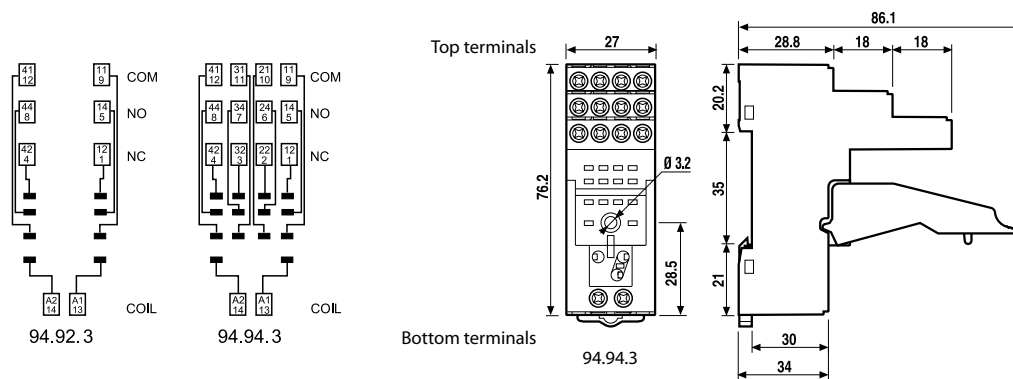

94.06

6-way jumper link for 94.92.3 and 94.94.3 sockets	094.06 (blue)	094.06.0 (black)
Rated values	10 A - 250 V	

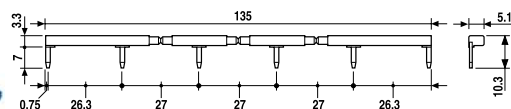

99.80

Approvals
(according to type):



* Modules in Black housing are available on request.

Green LED is standard.
Red LED available on request.

99.80 coil indication and EMC suppression modules for 94.92.3 and 94.94.3 sockets		Blue*
Diode (+A1, standard polarity)	(6...220)V DC	99.80.3.000.00
LED	(6...24)V DC/AC	99.80.0.024.59
LED	(28...60)V DC/AC	99.80.0.060.59
LED	(110...240)V DC/AC	99.80.0.230.59
LED + Diode (+A1, standard polarity)	(6...24)V DC	99.80.9.024.99
LED + Diode (+A1, standard polarity)	(28...60)V DC	99.80.9.060.99
LED + Diode (+A1, standard polarity)	(110...220)V DC	99.80.9.220.99
LED + Varistor	(6...24)V DC/AC	99.80.0.024.98
LED + Varistor	(28...60)V DC/AC	99.80.0.060.98
LED + Varistor	(110...240)V DC/AC	99.80.0.230.98
RC circuit	(6...24)V DC/AC	99.80.0.024.09
RC circuit	(28...60)V DC/AC	99.80.0.060.09
RC circuit	(110...240)V DC/AC	99.80.0.230.09
Residual current by-pass	(110...240)V AC	99.80.8.230.07

A

94.74

Approvals
(according to type):



94.82

Approvals
(according to type):



Screw terminal (Plate clamp) socket panel or 35 mm (EN 60715) rail mount	94.72 Blue	94.72.0 Black	94.73 Blue	94.73.0 Black	94.74 Blue	94.74.0 Black
For relay type	55.32		55.33		55.32, 55.34	
Accessories						
Metal retaining clip (supplied with socket - packaging code SMA)					094.71	
Modules (see table below)					99.01	
Screw terminal (Plate clamp) socket: panel or 35 mm rail mount	94.82 (blue)			94.82.0 (black)		
For relay type	55.32			55.32		
Accessories						
Metal retaining clip (supplied with socket - packaging code SMA)					094.71	
Modules (see table below)					99.01	
Technical data						
Rated values	10 A - 250 V					
Dielectric strength	2 kV AC					
Protection category	IP 20					
Ambient temperature	°C -40...+70					
⊕ Screw torque	Nm 0.5					
Wire strip length	mm 8 (94.72/73/74)			mm 9 (94.82)		
Max. wire size for 94.72/73/74 and 94.82 sockets	solid wire			stranded wire		
	mm ² 1 x 2.5 / 2 x 1.5			mm ² 1 x 2.5 / 2 x 1.5		
	AWG 1 x 14 / 2 x 16			AWG 1 x 14 / 2 x 16		

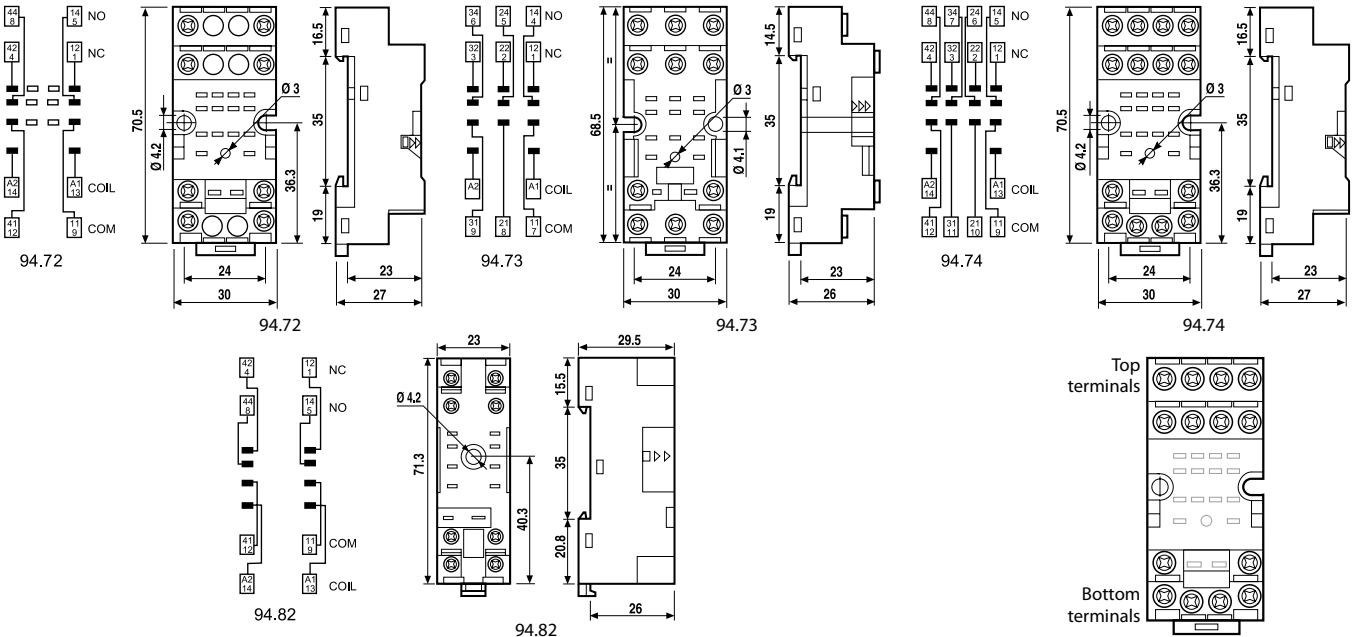

99.01 coil indication and EMC suppression modules for 94.72, 94.73, 94.74 and 94.82 sockets

	Blue*
Diode (+A1, standard polarity)	(6...220)V DC 99.01.3.000.00
Diode (+A2, non standard polarity)	(6...220)V DC 99.01.3.000.00
LED	(6...24)V DC/AC 99.01.0.024.59
LED	(28...60)V DC/AC 99.01.0.060.59
LED	(110...240)V DC/AC 99.01.0.230.59
LED + Diode (+A1, standard polarity)	(6...24)V DC 99.01.9.024.99
LED + Diode (+A1, standard polarity)	(28...60)V DC 99.01.9.060.99
LED + Diode (+A1, standard polarity)	(110...220)V DC 99.01.9.220.99
LED + Diode (+A2, non standard polarity)	(6...24)V DC 99.01.9.024.99
LED + Diode (+A2, non standard polarity)	(28...60)V DC 99.01.9.060.99
LED + Diode (+A2, non standard polarity)	(110...220)V DC 99.01.9.220.99
LED + Varistor	(6...24)V DC/AC 99.01.0.024.98
LED + Varistor	(28...60)V DC/AC 99.01.0.060.98
LED + Varistor	(110...240)V DC/AC 99.01.0.230.98
RC circuit	(6...24)V DC/AC 99.01.0.024.09
RC circuit	(28...60)V DC/AC 99.01.0.060.09
RC circuit	(110...240)V DC/AC 99.01.0.230.09
Residual current by-pass	(110...240)V AC 99.01.8.230.07

99.01

Approvals
(according to type):



* Modules in Black housing are available on request.

Green LED is standard.
Red LED available on request.



A 94.14

Approvals
(according to type):



PCB socket	94.12 Blue	94.12.0 Black	94.13 Blue	94.13.0 Black	94.14 Blue	94.14.0 Black
For relay type	55.32		55.33		55.32, 55.34	
Accessories						
Metal retaining clip (supplied with socket - packaging code SMA)	094.51					
Technical data						
Rated values	10 A - 250 V					
Dielectric strength	2 kV AC					
Ambient temperature	°C -40...+70					

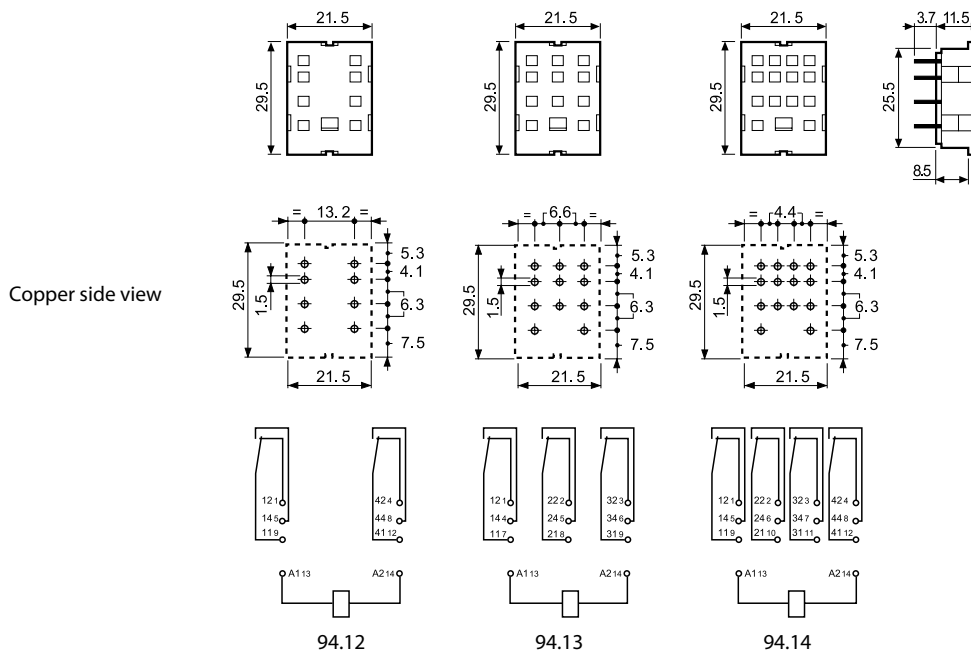

94.22

Approvals
(according to type):



Panel mount solder socket 1 mm thick panel	94.22 Blue	94.22.0 Black	94.23 Blue	94.23.0 Black	94.24 Blue	94.24.0 Black
For relay type	55.32		55.33		55.32, 55.34	
Accessories						
Metal retaining clip (supplied with socket - packaging code SMA)	094.51					
Technical data						
Rated values	10 A - 250 V					
Dielectric strength	2 kV AC					
Ambient temperature	°C -40...+70					

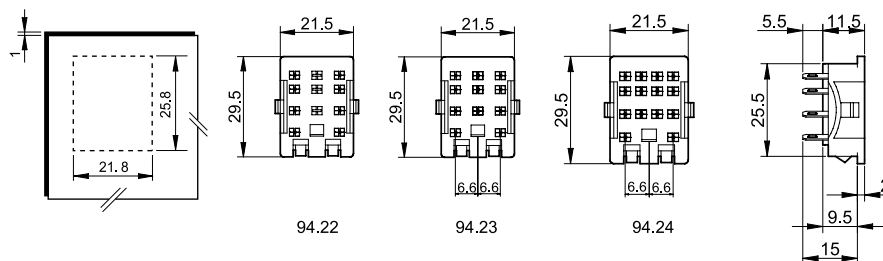



94.34

Approvals
(according to type):



Panel mount socket M3 screw fixing - solder connections	94.32 Blue	94.32.0 Black	94.33 Blue	94.33.0 Black	94.34 Blue	94.34.0 Black
For relay type	55.32		55.33		55.32, 55.34	
Accessories						
Metal retaining clip (supplied with socket - packaging code SMA)			094.51			
Technical data						
Rated values	10 A - 250 V					
Dielectric strength	2 kV AC					
Ambient temperature	°C -40...+70					

A

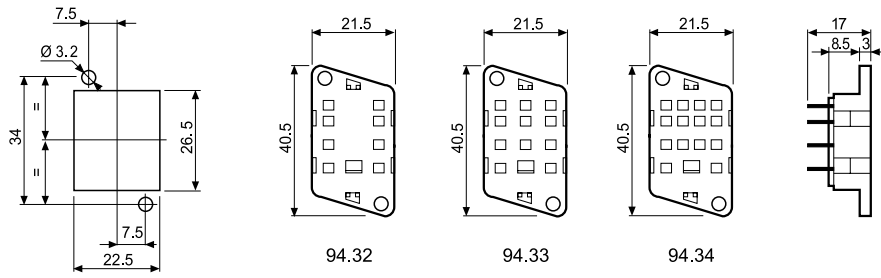

Packaging codes

How to code and identify retaining clip and packaging options for sockets.

Example:



- A** Standard packaging
- SM** Metal retaining clip
- SP** Plastic retaining clip



Miniature power relays 12 A



Industrial furnaces and ovens



Control and management of electric power



Industrial motors



Circuit breakers and switches



Panels for electrical distribution



Control panels



Carousel warehouses



Vending machines

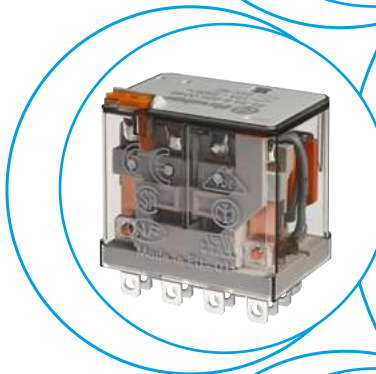

Plug-in - 12 A Power relay, 2 & 4 pole

- Flange mount option - (Faston 187, 4.8 x 0.5 mm termination)
- AC coils & DC coils
- Lockable test button and mechanical flag indicator
- Cadmium Free contacts (standard version)
- Contact material options
- 96 series sockets
- Coil EMC suppression
- Accessories
- European Patent

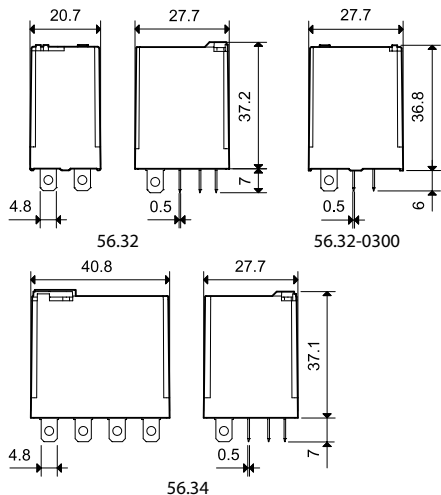

* For 4 CO (4PDT) only.

FOR UL RATINGS SEE:

"General technical information" page V

56.32/56.34



- 2 or 4 pole changeover contact
- Plug-in/Faston 187

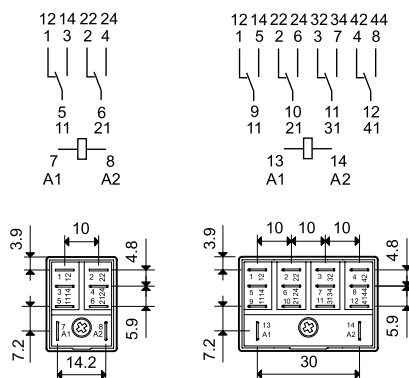

56.32

56.34

56.32-0300



- 2 pole normally open contact (≥ 1.5 mm gap)
- Plug-in/Faston 187

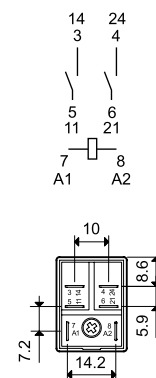

56.32-0300

Contact specification

Contact configuration	2 CO (DPDT)	4 CO (4PDT)	2NO (DPST-NO) - ≥ 1.5 mm gap
Rated current/Maximum peak current	A 12/20		12/20
Rated voltage/Maximum switching voltage	V AC 250/400		250/400
Rated load AC1	VA 3000		3000
Rated load AC15 (230 V AC)	VA 700		700
Single phase motor rating (230 V AC)	kW 0.55		0.55
Breaking capacity DC1: 30/110/220 V	A 12/0.5/0.25		12/1/0.5
Minimum switching load	mW (V/mA) 500 (10/5)		500 (10/5)
Standard contact material	AgNi		AgNi

Coil specification

Nominal voltage (U_N)	V AC (50/60 Hz)	6 - 12 - 24 - 48 - 60 - 110 - 120 - 230 - 240 - 400*	
	V DC	6 - 12 - 24 - 48 - 60 - 110 - 125 - 220	
Rated power AC/DC	VA (50 Hz)/W	1.5/1	2/1.3
Operating range	AC	$(0.8 \dots 1.1) U_N$	
	DC	$(0.8 \dots 1.1) U_N$	$(0.8 \dots 1.1) U_N$
Holding voltage	AC/DC	$0.8 U_N / 0.6 U_N$	
Must drop-out voltage	AC/DC	$0.2 U_N / 0.1 U_N$	

Technical data

Mechanical life AC/DC	cycles	$20 \cdot 10^6 / 50 \cdot 10^6$	
Electrical life at rated load AC1	cycles	$100 \cdot 10^3$	
Operate/release time	ms	8/3	10/4
Insulation between coil and contacts (1.2/50 μ s)	kV	4	5
Dielectric strength between open contacts	V AC	1000	
Ambient temperature range	$^{\circ}$ C	-40...+70	
Environmental protection		RT I	

Approvals (according to type)



Printed circuit mount
12 A Power relay

- 2 & 4 pole
- AC coils & DC coils
- Cadmium Free contacts (standard version)
- Contact material option
- RT III (wash tight) option available

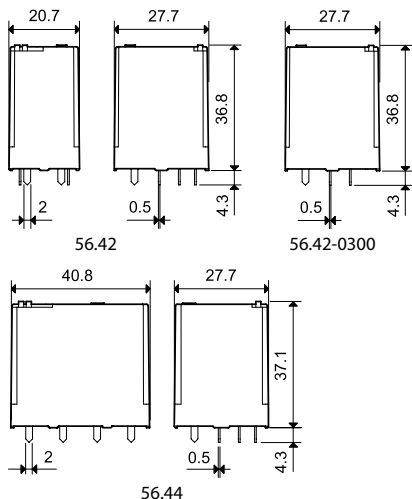

* For 4 CO (4PDT) only.

FOR UL RATINGS SEE:

"General technical information" page V

Contact specification

Contact configuration		2 CO (DPDT)	4 CO (4PDT)	2NO (DPST-NO) - ≥ 1.5 mm gap
Rated current/Maximum peak current	A	12/20		12/20
Rated voltage/ Maximum switching voltage	V AC	250/400		250/400
Rated load AC1	VA	3000		3000
Rated load AC15 (230 V AC)	VA	700		700
Single phase motor rating (230 V AC)	kW	0.55		0.55
Breaking capacity DC1: 30/110/220 V	A	12/0.5/0.25		12/1/0.5
Minimum switching load	mW (V/mA)	500 (10/5)		500 (10/5)
Standard contact material		AgNi		AgNi

Coil specification

Nominal voltage (U_N)	V AC (50/60 Hz)	6 - 12 - 24 - 48 - 60 - 110 - 120 - 230 - 240 - 400*		
	V DC	6 - 12 - 24 - 48 - 60 - 110 - 125 - 220		
Rated power AC/DC	VA (50 Hz)/W	1.5/1	2/1.3	1.5/—
Operating range	AC	$(0.8 \dots 1.1) U_N$		$(0.85 \dots 1.1) U_N$
	DC	$(0.8 \dots 1.1) U_N$	$(0.8 \dots 1.1) U_N$	—
Holding voltage	AC/DC	$0.8 U_N / 0.6 U_N$		$0.85 U_N / —$
Must drop-out voltage	AC/DC	$0.2 U_N / 0.1 U_N$		$0.2 U_N / —$

Technical data

Mechanical life AC/DC	cycles	$20 \cdot 10^6 / 50 \cdot 10^6$		$20 \cdot 10^6 / —$
Electrical life at rated load AC1	cycles	$100 \cdot 10^3$		$100 \cdot 10^3$
Operate/release time	ms	8/3	10/4	8/4
Insulation between coil and contacts (1.2/50 μ s)	kV	4	5	4
Dielectric strength between open contacts	V AC	1000		2000
Ambient temperature range	$^{\circ}$ C	-40...+70		-40...+70
Environmental protection		RT I		RT I

Approvals (according to type)



56.42/56.44



- 2 or 4 pole changeover contact
- PCB mount

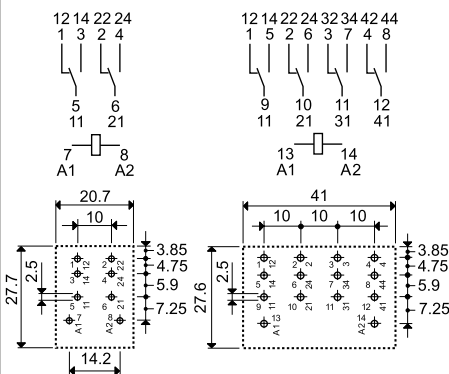

56.42
Copper side view

56.44
Copper side view

56.42-0300



- 2 pole normally open contact (≥ 1.5 mm gap)
- PCB mount

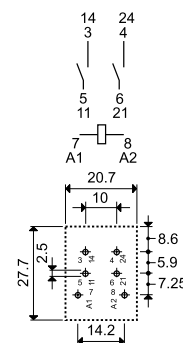

56.42-0300
Copper side view

Ordering information

Example: 56 series plug-in relay, 2 CO (DPDT), 12 V DC coil, lockable test button and mechanical indicator.

<p>Series —————</p> <p>Type —————</p> <p>3 = Plug-in 4 = PCB</p> <p>No. of poles —————</p> <p>2 = 2 pole, 12 A 4 = 4 pole, 12 A</p> <p>Coil version —————</p> <p>8 = AC (50/60 Hz) 9 = DC</p> <p>Coil voltage —————</p> <p>See coil specifications</p>	<p>5 6 . 3 2 . 9 . 0 1 2 . 0 0 4 0</p>	<p>A: Contact material 0 = Standard AgNi 2 = AgCdO 4 = AgSnO₂</p> <p>B: Contact circuit 0 = CO (nPDT) 3 = NO (nPST), ≥ 1.5 mm contact gap</p>	<p>D: Special versions 0 = Standard 1 = Wash tight (RT III) for 56.42 and 56.44 only 6 = Rear flange mount (4 pole only) 8 = Rear 35 mm rail mount (4 pole only) For other mounting options see page 8</p> <p>C: Options 0 = None 2 = Mechanical indicator 3* = LED (AC) 4 = Lockable test button + mechanical indicator 5* = Lockable test button + LED (AC) 54* = Lockable test button + LED (AC) + mechanical indicator 6* = Double LED (DC non-polarized) 7* = Lockable test button + double LED (DC non-polarized) 74* = Lockable test button + double LED (DC non-polarized) + mechanical indicator 8* = LED + diode (DC, polarity positive to pin 7) for 56.32 only 9* = Lockable test button + LED + diode (DC, polarity positive to pin 7) for 56.32 only 94* = Lockable test button + LED + diode (DC, polarity positive to pin 7) + mechanical indicator for 56.32 only</p> <p>* Options not available for 220 V DC and 400 V AC versions.</p>
---	---	--	---

Selecting features and options: only combinations in the same row are possible.

Preferred selections for best availability are shown in **bold**.

Type	Coil version	A	B	C	D
56.32	AC	0 - 2 - 4	0	0 - 2 - 3 - 4 - 5	0
	AC	0 - 2 - 4	0	54	/
	AC	0 - 2 - 4	3	0 - 3 - 5	0
	DC	0 - 2 - 4	0	0 - 2 - 4 - 6 - 7 - 8 - 9	0
	DC	0 - 2 - 4	0	74 - 94	/
56.34	AC	0 - 2 - 4	0	0 - 2 - 3 - 4 - 5	0 - 6 - 8
	AC	0 - 2 - 4	0	54	/
	DC	0 - 2 - 4	0	0 - 2 - 4 - 6 - 7	0 - 6 - 8
	DC	0 - 2 - 4	0	74	/
56.42	DC	0 - 2 - 4	0	0	0 - 1
	AC	0 - 2 - 4	0 - 3	0	0 - 1
56.44	AC - DC	0 - 2 - 4	0	0	0 - 1

Special versions for Rail Applications on request

Descriptions: options and special versions

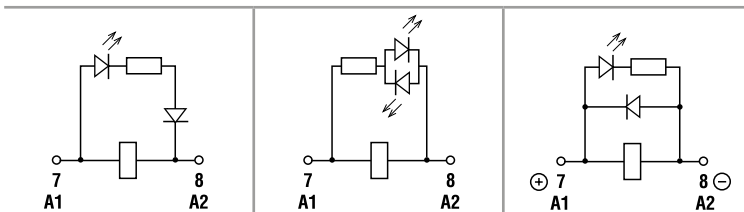

C: Option 3, 5, 54
LED (AC)

C: Option 6, 7, 74
Double LED
(DC non-polarized)

C: Option 8, 9, 94
LED + diode (DC, polarity positive to pin 7) - (56.32 only)

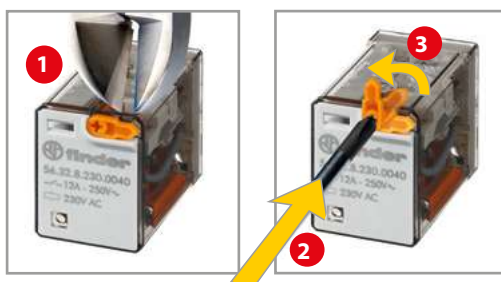

Lockable test button and mechanical flag indicator (0040, 0050, 0054, 0070, 0074, 0090, 0094)

The dual-purpose Finder test button can be used in two ways:

Case 1) The plastic pip (located directly above the test button) remains intact. In this case, when the test button is pushed, the contacts operate. When the test button is released the contacts return to their former state.

Case 2) The plastic pip is broken-off (using an appropriate cutting tool). In this case, (in addition to the above function), when the test button is pushed and rotated, the contacts are latched in the operating state, and remain so until the test button is rotated back to its former position.

In both cases ensure that the test button actuation is swift and decisive.

Technical data

* Only in applications where over voltage category II is permitted. In applications of over voltage category III: Micro-disconnection.

Insulation according to EN 61810-1		2 CO - 4 CO		2 NO	
Nominal voltage of supply system	V AC	230/400		230/400	
Rated insulation voltage	V AC	250	400	250	400
Pollution degree		3	2	3	2
Insulation between coil and contact set					
Type of Insulation		Basic		Basic	
Overvoltage category		III		III	
Rated impulse voltage	kV (1.2/50 μ s)	4		4	
Dielectric strength	V AC	2500		2500	
Insulation between adjacent contacts					
Type of insulation		Basic		Basic	
Overvoltage category		III		III	
Rated impulse voltage	kV (1.2/50 μ s)	4		4	
Dielectric strength	V AC	2500		2500	
Insulation between open contacts					
Type of disconnection		Micro-disconnection		Full-disconnection*	
Overvoltage category		—		II	
Rated impulse voltage	kV (1.2/50 μ s)	—		2.5	
Dielectric strength	V AC/kV (1.2/50 μ s)	1000/1.5		2000/3	
Conducted disturbance immunity					
Burst (5...50)ns, 5 kHz, on A1 - A2 according to EN 61000-4-4		level 4 (4 kV)			
Surge (1.2/50 μ s) on A1 - A2 (differential mode) according to EN 61000-4-5		level 4 (4 kV)			
Other data					
Bounce time: NO/NC	ms	1/4 (changeover)		3/— (normally open)	
Vibration resistance (5...55)Hz: NO/NC	g	17/14			
Shock resistance	g	20/14			
Power lost to the environment	without contact current	W	1 (56.32, 56.42)		1.3 (56.34, 56.44)
	with rated current	W	3.8 (56.32, 56.42)		6.9 (56.34, 56.44)
Recommended distance between relays mounted on PCB	mm	≥ 5			

Contact specification

F 56 - Electrical life (AC) v contact current

2 - 4 pole relays

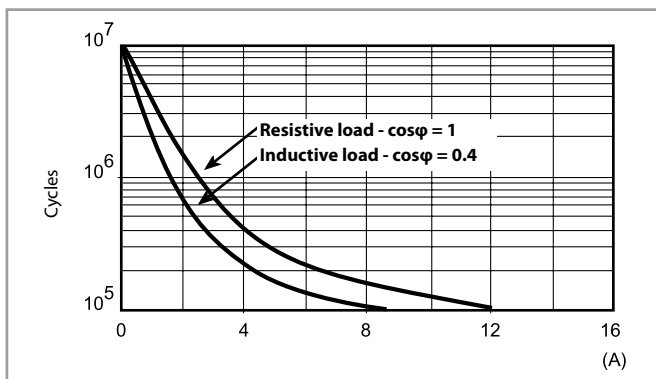

H 56 - Maximum DC1 breaking capacity

Changeover version

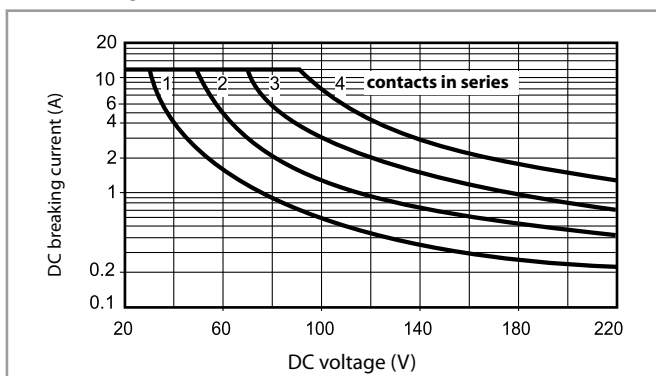

H 56 - Maximum DC1 breaking capacity

Normally open version

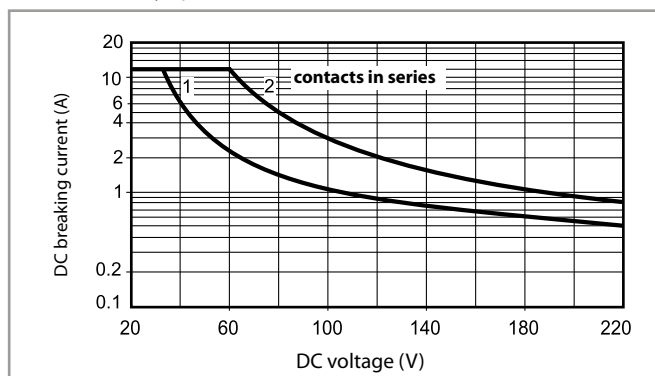

- When switching a resistive load (DC1) having voltage and current values under the curve, an electrical life of $\geq 100 \cdot 10^3$ can be expected.
- In the case of DC13 loads, the connection of a diode in parallel with the load will permit a similar electrical life as for a DC1 load.

Note: the release time of the load will be increased.

Coil specifications

DC coil data, 2 pole relay

Nominal voltage U_N	Coil code	Operating range		Resistance R	Rated coil consumption I at U_N
		U_{min}	U_{max}		
V		V	V	Ω	mA
6	9.006	4.8	6.6	40	150
12	9.012	9.6	13.2	140	86
24	9.024	19.2	26.4	600	40
48	9.048	38.4	52.8	2400	20
60	9.060	48	66	4000	15
110	9.110	88	121	12500	8.8
125	9.125	100	138	17300	7.2
220	9.220	176	242	54000	4

AC coil data, 2 pole relay

Nominal voltage U_N	Coil code	Operating range		Resistance R	Rated coil consumption I at U_N (50 Hz)
		U_{min}^*	U_{max}		
V		V	V	Ω	mA
6	8.006	4.8	6.6	12	200
12	8.012	9.6	13.2	50	97
24	8.024	19.2	26.4	190	53
48	8.048	38.4	52.8	770	25
60	8.060	48	66	1200	21
110	8.110	88	121	3940	12.5
120	8.120	96	132	4700	12
230	8.230	184	253	17000	6
240	8.240	192	264	19100	5.3

* $U_{min} = 0.85 U_N$ for normally open version.

DC coil data, 4 pole relay

Nominal voltage U_N	Coil code	Operating range		Resistance R	Rated coil consumption I at U_N
		U_{min}	U_{max}		
V		V	V	Ω	mA
6	9.006	4.8	6.6	32.5	185
12	9.012	9.6	13.2	123	97
24	9.024	19.2	26.4	490	49
48	9.048	38.4	52.8	1800	27
60	9.060	48	66	3000	20
110	9.110	88	121	10400	10.5
125	9.125	100	138	14200	8.8
220	9.220	176	242	44000	5

AC coil data, 4 pole relay

Nominal voltage U_N	Coil code	Operating range		Resistance R	Rated coil consumption I at U_N (50 Hz)
		U_{min}	U_{max}		
V		V	V	Ω	mA
6	8.006	4.8	6.6	5.7	300
12	8.012	9.6	13.2	22	150
24	8.024	19.2	26.4	81	90
48	8.048	38.4	52.8	380	37
60	8.060	48	66	600	30
110	8.110	88	121	1900	16.5
120	8.120	96	132	2560	13.4
230	8.230	184	253	7700	9
240	8.240	192	264	10000	7.5
400	8.400	320	440	26000	4.9

R 56 - DC coil operating range v ambient temperature
2 and 4 pole relay

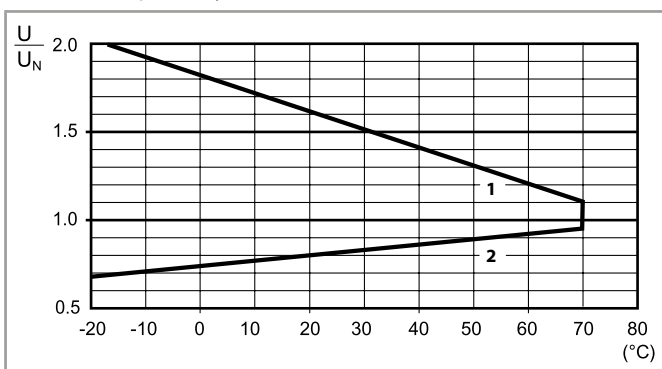

- 1 - Max. permitted coil voltage.
- 2 - Min. pick-up voltage with coil at ambient temperature.

R 56 - AC coil operating range v ambient temperature
2 pole relay

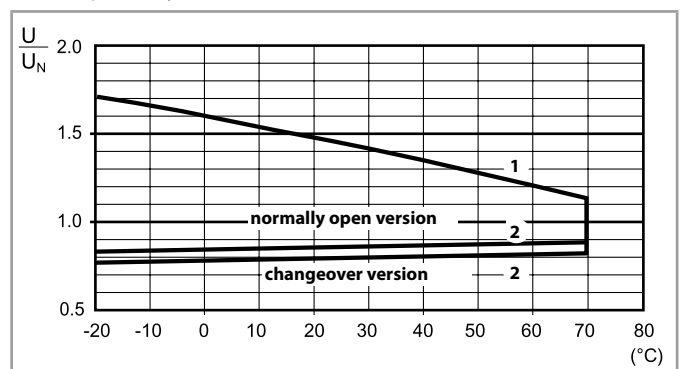

R 56 - AC coil operating range v ambient temperature
4 pole relay

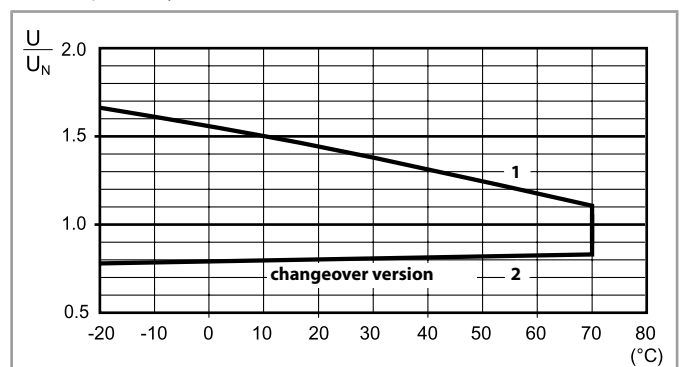

- 1 - Max. permitted coil voltage.
- 2 - Min. pick-up voltage with coil at ambient temperature.

Accessories

A



056.25



056.25 with relay

Top flange mount adaptor for 56.32

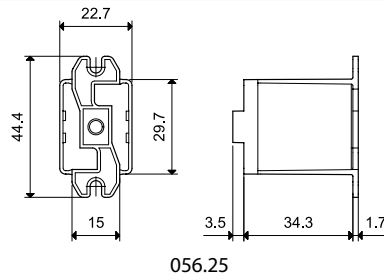

056.25

056.25

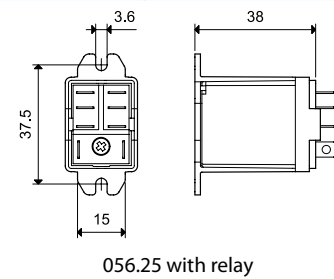

056.25 with relay



056.26



056.26 with relay

Rear flange mount adaptor for 56.32

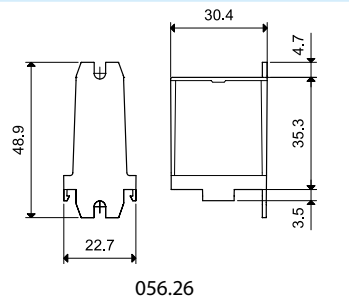

056.26

056.26

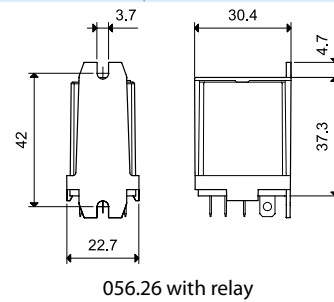

056.26 with relay



056.27



056.27 with relay

Top 35 mm rail (EN 60715) adaptor for 56.32

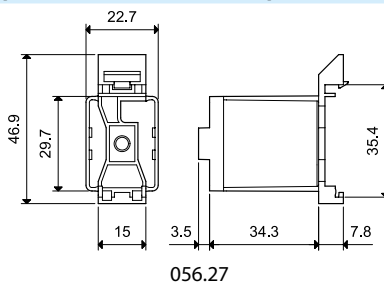

056.27

056.27

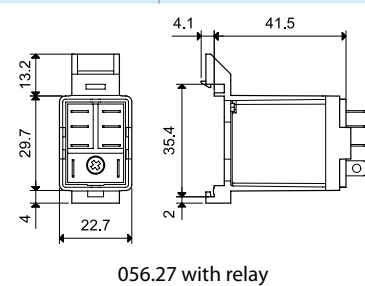

056.27 with relay



056.45



056.45 with relay

Top flange mount adaptor for 56.34

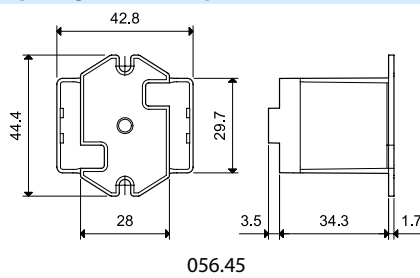

056.45

056.45

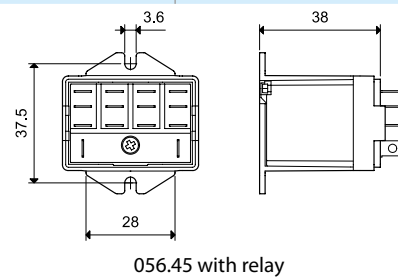

056.45 with relay



056.47



056.47 with relay

Top 35 mm rail (EN 60715) adaptor for 56.34

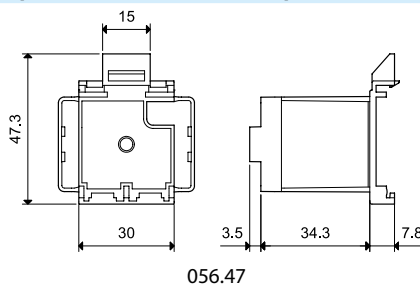

056.47

056.47

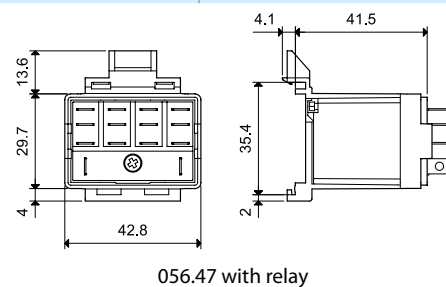

056.47 with relay

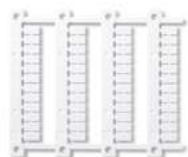

060.48

Sheet of marker tags for relay type 56.34, plastic, 48 tags, 6 x 12 mm, for CEMBRE thermal transfer printers

060.48



96.02
Approvals
(according to type):



96.04
Approvals
(according to type):



094.91.3

Screw terminal (Box clamp) socket panel or 35 mm rail mount (EN 60715)	96.02 Blue	96.02.0 Black	96.04 Blue	96.04.0 Black
For relay type	56.32		56.34	
Accessories				
Metal retaining clip (supplied with socket - packaging code SMA)	094.71		096.71	
Plastic retaining and release clip (supplied with socket - packaging code SPA)	094.91.3	094.91.30	—	—
6-way jumper link	094.06	094.06.0	—	—
Identification tag	095.00.4		090.00.2	
Modules (see table below)	99.02			
Timer modules (see table below)	86.30		86.00, 86.30	
Sheet of marker tags for retaining and release clip 094.91.3, plastic, 48 tags, 6 x 12 mm, for CEMBRE thermal transfer printers	060.48		—	
Technical data				
Rated values	10 A - 250 V			
Dielectric strength	2 kV AC			
Protection category	IP 20			
Ambient temperature	°C -40...+70 (see diagram L96)			
⊕ Screw torque	Nm	0.8		
Wire strip length	mm	8		
Max. wire size for 94.02/04 sockets		solid wire	stranded wire	
	mm ²	1 x 6 / 2 x 2.5		1 x 4 / 2 x 2.5
	AWG	1 x 10 / 2 x 14		1 x 12 / 2 x 14

L 96 - Rated current v ambient temperature

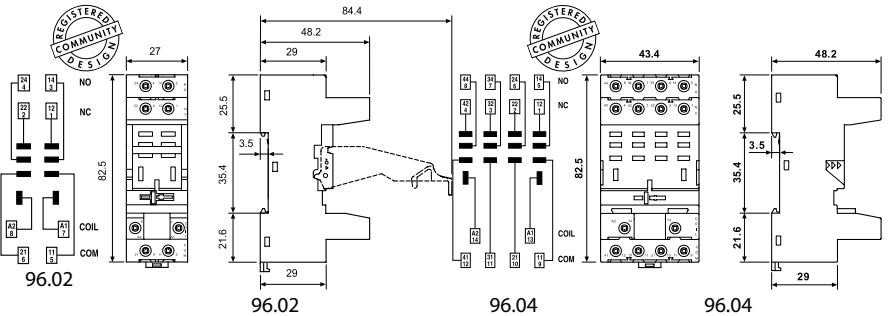
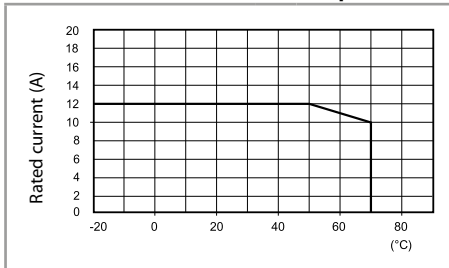

094.06



86.00



86.30



99.02

Approvals
(according to type):



DC Modules with non-standard polarity (+A2) on request.

6-way jumper link for 96.02 socket	094.06 (blue)	094.06.0 (black)
Rated values	10 A - 250 V	

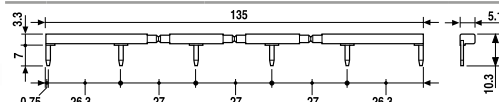

86 series timer modules		
Multi-voltage: (12...240)V AC/DC;		
Multi-functions: AI, DI, SW, BE, CE, DE, EE, FE; (0.05 s...100 h)		86.00.0.240.0000
(12...24)V AC/DC; Bi-function: AI, DI; (0.05 s...100 h)		86.30.0.024.0000
(110...125)V AC; Bi-function: AI, DI; (0.05 s...100 h)		86.30.8.120.0000
(230...240)V AC; Bi-function: AI, DI; (0.05 s...100 h)		86.30.8.240.0000

Approvals (according to type): **CE EAC cRU US**

99.02 coil indication and EMC suppression modules for 96.02 and 96.04 sockets		
Diode (+A1, standard polarity)	(6...220)V DC	99.02.3.000.00
LED	(6...24)V DC/AC	99.02.0.024.59
LED	(28...60)V DC/AC	99.02.0.060.59
LED	(110...240)V DC/AC	99.02.0.230.59
LED + Diode (+A1, standard polarity)	(6...24)V DC	99.02.9.024.99
LED + Diode (+A1, standard polarity)	(28...60)V DC	99.02.9.060.99
LED + Diode (+A1, standard polarity)	(110...220)V DC	99.02.9.220.99
LED + Varistor	(6...24)V DC/AC	99.02.0.024.98
LED + Varistor	(28...60)V DC/AC	99.02.0.060.98
LED + Varistor	(110...240)V DC/AC	99.02.0.230.98
RC circuit	(6...24)V DC/AC	99.02.0.024.09
RC circuit	(28...60)V DC/AC	99.02.0.060.09
RC circuit	(110...240)V DC/AC	99.02.0.230.09
Residual current by-pass	(110...240)V AC	99.02.8.230.07

A



96.72

Approvals
(according to type):



96.74

Approvals
(according to type):



Screw terminal (Plate clamp) socket panel or 35 mm rail (EN 60715) mount	96.72 Blue	96.72.0 Black	96.74 Blue	96.74.0 Black
For relay type	56.32		56.34	
Accessories				
Metal retaining clip (supplied with socket - packaging code SMA)	094.71		096.71	
Modules (see table below)	99.01			
Technical data				
Rated values	12 A - 250 V			
Dielectric strength	2 kV AC			
Protection category	IP 20			
Ambient temperature	°C -40...+70			
Screw torque	Nm	0.8		
Wire strip length	mm	10		
Max. wire size for 96.72 and 96.74 sockets		solid wire	stranded wire	
	mm ²	1 x 4 / 2 x 4	1 x 4 / 2 x 2.5	
	AWG	1 x 12 / 2 x 12	1 x 12 / 2 x 14	

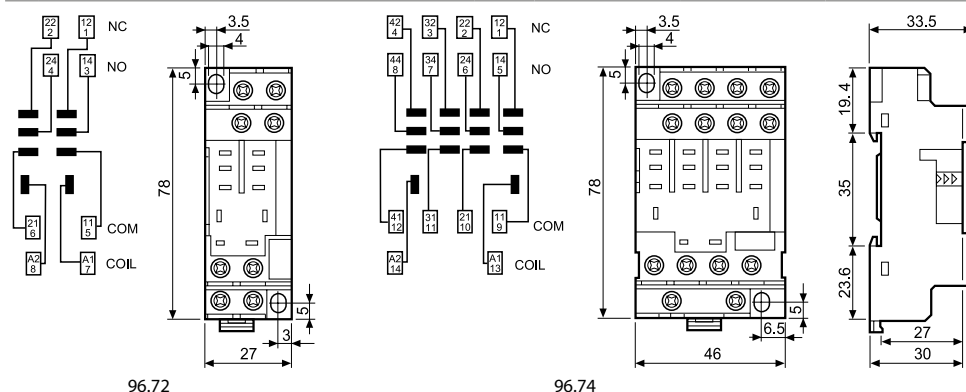

99.01

Approvals
(according to type):



* Modules in Black housing are available on request.
Green LED is standard.
Red LED available on request.

99.01 coil indication and EMC suppression modules for types 96.72 and 96.74 sockets		
		Blue*
Diode (+A1, standard polarity)	(6...220)V DC	99.01.3.000.00
Diode (+A2, non-standard polarity)	(6...220)V DC	99.01.2.000.00
LED	(6...24)V DC/AC	99.01.0.024.59
LED	(28...60)V DC/AC	99.01.0.060.59
LED	(110...240)V DC/AC	99.01.0.230.59
LED + Diode (+A1, standard polarity)	(6...24)V DC	99.01.9.024.99
LED + Diode (+A1, standard polarity)	(28...60)V DC	99.01.9.060.99
LED + Diode (+A1, standard polarity)	(110...220)V DC	99.01.9.220.99
LED + Diode (+A2, non-standard polarity)	(6...24)V DC	99.01.9.024.79
LED + Diode (+A2, non-standard polarity)	(28...60)V DC	99.01.9.060.79
LED + Diode (+A2, non-standard polarity)	(110...220)V DC	99.01.9.220.79
LED + Varistor	(6...24)V DC/AC	99.01.0.024.98
LED + Varistor	(28...60)V DC/AC	99.01.0.060.98
LED + Varistor	(110...240)V DC/AC	99.01.0.230.98
RC circuit	(6...24)V DC/AC	99.01.0.024.09
RC circuit	(28...60)V DC/AC	99.01.0.060.09
RC circuit	(110...240)V DC/AC	99.01.0.230.09
Residual current by-pass	(110...240)V AC	99.01.8.230.07



96.12

Approvals
(according to type):



PCB socket	96.12 (blue)	96.12.0 (blue)	96.14 (blue)	96.14.0 (blue)
For relay type	56.32		56.34	
Accessories	094.51			
Technical data				
Rated values	15 A - 250 V			
Dielectric strength	2 kV AC			
Protection category	IP 20			
Ambient temperature	°C -40...+70			

A

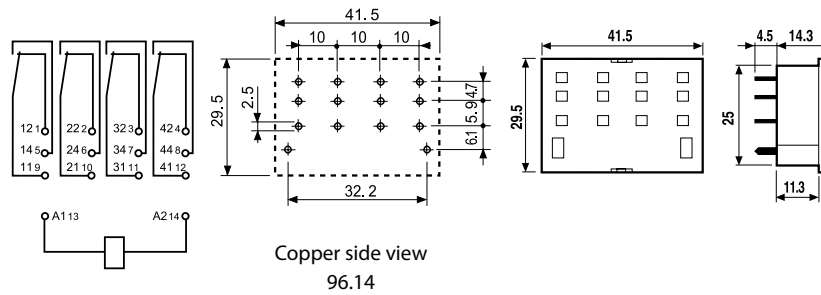
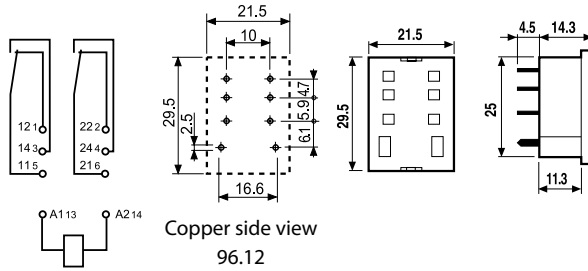

Packaging codes

How to code and identify retaining clip and packaging options for sockets.

Example:



- A** Standard packaging
- SM** Metal retaining clip
- SP** Plastic retaining clip





finder[®]
SWITCH TO THE FUTURE

60
SERIES

General purpose relays 6 - 10 A



Shipyards



Hoists and cranes



Road / tunnel
lighting



Burners, boilers
and furnaces



Wood-processing
machines



Panels for electrical
distribution



Control panels



Control systems



Plug-in mount
10 A General purpose relay

Type 60.12

- 2 pole, 10 A

Type 60.13

- 3 pole, 10 A

- 2 & 3 pole changeover contacts
- Cadmium Free contacts (preferred version)
- AC coils & DC coils
- UL Listing (certain relay/socket combinations)
- Contact material options
- Lockable test button with mechanical flag indicator (preferred version)
- 90 series sockets
- Coil EMC suppression
- Timer accessories 86 series
- European Patent

FOR UL RATINGS SEE:

"General technical information" page V

For outline drawing see page 8

Contact specification

Contact configuration		2 CO (DPDT)	3 CO (3PDT)
Rated current/Maximum peak current	A	10/20	10/20
Rated voltage/ Maximum switching voltage	V AC	250/400	250/400
Rated load AC1	VA	2500	2500
Rated load AC15 (230 V AC)	VA	500	500
Single phase motor rating (230 V AC)	kW	0.37	0.37
Breaking capacity DC1: 30/110/220 V	A	10/0.4/0.15	10/0.4/0.15
Minimum switching load	mW (V/mA)	500 (10/5)	500 (10/5)
Standard contact material		AgNi	AgNi

Coil specification

Nominal voltage (U _N)	V AC (50/60 Hz)	6 - 12 - 24 - 48 - 60 - 110 - 120 - 230 - 240 - 400
	V DC	6 - 12 - 24 - 48 - 60 - 110 - 125 - 220
Rated power AC/DC	VA (50 Hz)/W	2.2/1.3
Operating range	AC	(0.8...1.1)U _N
	DC	(0.8...1.1)U _N
Holding voltage	AC/DC	0.8 U _N / 0.5 U _N
Must drop-out voltage	AC/DC	0.2 U _N / 0.1 U _N

Technical data

Mechanical life AC/DC	cycles	20 · 10 ⁶ / 50 · 10 ⁶	20 · 10 ⁶ / 50 · 10 ⁶
Electrical life at rated load AC1	cycles	200 · 10 ³	200 · 10 ³
Operate/release time	ms	11/4	11/4
Insulation between coil and contacts (1.2/50 μs)	kV	4	3.6
Dielectric strength between open contacts	V AC	1000	1000
Ambient temperature range	°C	-40...+70	-40...+70
Environmental protection		RT I	RT I

Approvals (according to type)



60.12

- 2 pole, 10 A
- 8 pin plug-in

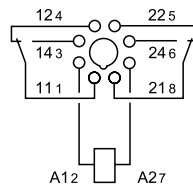

60.13

- 3 pole, 10 A
- 11 pin plug-in

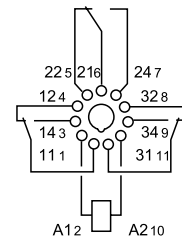

Plug-in mount - 6 A**Bifurcated contacts for low level switching****Type 60.12 - 52xx**

- 2 pole, 6 A

Type 60.13 - 52xx

- 3 pole, 6 A

- 2 & 3 pole changeover contacts
- Cadmium Free contacts (Gold plated Silver Nickel)
- AC coils & DC coils
- Lockable test button with mechanical flag indicator (preferred version)
- 90 series sockets
- Coil EMC suppression
- Timer accessories 86 series
- European Patent

60.12 - 52xx

- 2 pole, 6 A
- Bifurcated contacts with AgNi + Au
- 8 pin plug-in

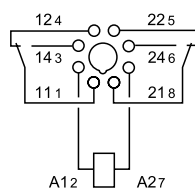
**60.13 - 52xx**

- 3 pole, 6 A
- Bifurcated contacts with AgNi + Au
- 11 pin plug-in

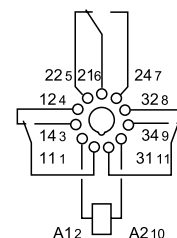

FOR UL RATINGS SEE:

"General technical information" page V

For outline drawing see page 8

Contact specification

Contact configuration		2 CO (DPDT)	3 CO (3PDT)
Rated current/Maximum peak current	A	6/10	6/10
Rated voltage/Maximum switching voltage	V AC	250/400	250/400
Rated load AC1	VA	1500	1500
Rated load AC15 (230 V AC)	VA	250	250
Single phase motor rating (230 V AC)	kW	0.185	0.185
Breaking capacity DC1: 30/110/220 V	A	6/0.3/0.12	6/0.3/0.12
Minimum switching load	mW (V/mA)	50 (5/5)	50 (5/5)
Standard contact material		AgNi + Au	AgNi + Au

Coil specification

Nominal voltage (U _N)	V AC (50/60 Hz)	6 - 12 - 24 - 48 - 60 - 110 - 120 - 230 - 240 - 400
	V DC	6 - 12 - 24 - 48 - 60 - 110 - 125 - 220
Rated power AC/DC	VA (50 Hz)/W	2.2/1.3
Operating range	AC	(0.8...1.1)U _N
	DC	(0.8...1.1)U _N
Holding voltage	AC/DC	0.8 U _N / 0.5 U _N
Must drop-out voltage	AC/DC	0.2 U _N / 0.1 U _N

Technical data

Mechanical life AC/DC	cycles	20 · 10 ⁶ / 50 · 10 ⁶	20 · 10 ⁶ / 50 · 10 ⁶
Electrical life at rated load AC1	cycles	250 · 10 ³	250 · 10 ³
Operate/release time	ms	11/4	11/4
Insulation between coil and contacts (1.2/50 μs)	kV	4	3.6
Dielectric strength between open contacts	V AC	1000	1000
Ambient temperature range	°C	-40...+70	-40...+70
Environmental protection		RT I	RT I

Approvals (according to type)

Flange mount - General purpose relay 10 A

Type 60.62

- 2 pole, 10 A

Type 60.63

- 3 pole, 10 A

- Faston 187, (4.8 x 0.8 mm)
- 2 & 3 pole changeover contacts
- AC coils & DC coils
- Cadmium Free contacts
- Contacts material options

60.62



- 2 pole, 10 A power contacts
- Flange mount
- Faston 187

60.63



- 3 pole, 10 A power contacts
- Flange mount
- Faston 187

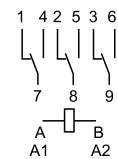
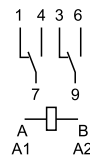

FOR UL RATINGS SEE:

"General technical information" page V

For outline drawing see page 8

Contact specification

Contact configuration		2 CO (DPDT)	3 CO (3PDT)
Rated current/Maximum peak current	A	10/20	10/20
Rated voltage/ Maximum switching voltage	V AC	250/400	250/400
Rated load AC1	VA	2500	2500
Rated load AC15 (230 V AC)	VA	500	500
Single phase motor rating (230 V AC)	kW	0.37	0.37
Breaking capacity DC1: 30/110/220 V	A	10/0.4/0.15	10/0.4/0.15
Minimum switching load	mW (V/mA)	500 (10/5)	500 (10/5)
Standard contact material		AgNi	AgNi

Coil specification

Nominal voltage (U _N)	V AC (50/60 Hz)	6 - 12 - 24 - 48 - 60 - 110 - 120 - 230 - 240 - 400	
	V DC	6 - 12 - 24 - 48 - 60 - 110 - 125 - 220	
Rated power AC/DC	VA (50 Hz)/W	2.2/1.3	2.2/1.3
Operating range	AC	(0.8...1.1)U _N	(0.8...1.1)U _N
	DC	(0.8...1.1)U _N	(0.8...1.1)U _N
Holding voltage	AC/DC	0.8 U _N / 0.5 U _N	0.8 U _N / 0.5 U _N
Must drop-out voltage	AC/DC	0.2 U _N / 0.1 U _N	0.2 U _N / 0.1 U _N

Technical data

Mechanical life AC/DC	cycles	20 · 10 ⁶ / 50 · 10 ⁶	20 · 10 ⁶ / 50 · 10 ⁶
Electrical life at rated load AC1	cycles	200 · 10 ³	200 · 10 ³
Operate/release time	ms	11/4	11/4
Insulation between coil and contacts (1.2/50 μs)	kV	4	3.6
Dielectric strength between open contacts	V AC	1000	1000
Ambient temperature range	°C	-40...+70	-40...+70
Environmental protection		RT I	RT I

Approvals (according to type)



Ordering information

Example: 60 series plug-in relay, 3 CO (3PDT), 12 V DC coil, test button and mechanical indicator.

A

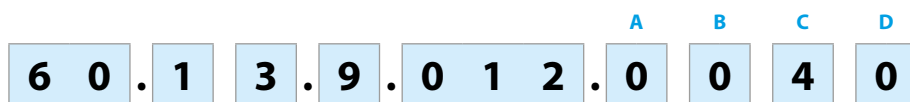

Series ————
Type ————
 1 = 8/11 pin plug-in
 6 = Faston 187 (4.8 x 0.8 mm) with flange mount
No. of poles ————
 2 = 2 pole
 3 = 3 pole
Coil version ————
 4 = Current sensing (60.12/13 only)
 8 = AC (50/60 Hz)
 9 = DC
Coil voltage ————
 See coil specifications

A: Contact material
 0 = Standard
 5 = AgNi + Au
B: Contact circuit
 0 = CO (nPDT)
 2 = Bifurcated contacts
 60.12/13 - 6 A only

D: Special versions
 0 = Standard
C: Options
 0 = None
 2 = Mechanical indicator
 3 = LED (AC)
 4 = Lockable test button + mechanical indicator
 5* = Lockable test button + LED (AC)
 54* = Lockable test button + LED (AC) + mechanical indicator
 6* = LED + diode (DC, polarity positive to pin 2)
 7* = Lockable test button + LED + diode (DC, polarity positive to pin 2)
 74* = Lockable test button + LED + diode (DC, polarity positive to pin 2) + mechanical indicator
 * Options not available for 220 V DC and 400 V AC versions.

Selecting features and options: only combinations in the same row are possible.
 Preferred selections for best availability are shown in **bold**.

Type	Coil version	A	B	C	D
60.12/13	AC	0	0	0 - 2 - 3 - 4 - 5	0
	AC	0	0	54	/
	AC	5	0 - 2	0 - 2 - 3 - 4 - 5	0
	AC	5	0 - 2	54	/
	DC	0	0	0 - 2 - 4 - 6 - 7	0
	DC	0	0	74	/
	DC	5	0 - 2	0 - 2 - 4 - 6 - 7	0
	DC	5	0 - 2	74	/
	current sensing	0	0	4	0
60.62/63	AC-DC	0 - 5	0	0	0

Descriptions: Options and Special versions

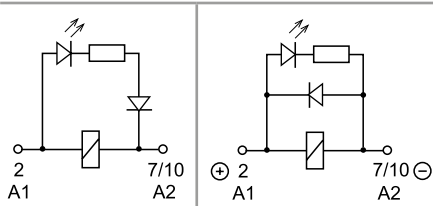

C: Option 3, 5, 54
 LED (AC)

C: Option 6, 7, 74
 LED + diode (DC, polarity positive to pin 2)



Lockable test button and mechanical flag indicator (0040, 0050, 0054, 0070, 0074)

The dual-purpose Finder test button can be used in two ways:

Case 1) The plastic pip (located directly above the test button) remains intact. In this case, when the test button is pushed, the contacts operate. When the test button is released the contacts return to their former state.

Case 2) The plastic pip is broken-off (using an appropriate cutting tool). In this case, (in addition to the above function), when the test button is pushed and rotated, the contacts are latched in the operating state, and remain so until the test button is rotated back to its former position.

In both cases ensure that the test button actuation is swift and decisive.



Technical data

Insulation according to EN 61810-1		2 pole		3 pole	
Nominal voltage of supply system	V AC	230/400		230/400	
Rated insulation voltage	V AC	250	400	250	400
Pollution degree		3	2	3	2
Insulation between coil and contact set					
Type of insulation		Basic		Basic	
Overvoltage category		III		III	
Rated impulse voltage	kV (1.2/50 μs)	4		3.6	
Dielectric strength	V AC	2000		2000	
Insulation between adjacent contacts					
Type of insulation		Basic		Basic	
Overvoltage category		III		III	
Rated impulse voltage	kV (1.2/50 μs)	4		3.6	
Dielectric strength	V AC	2000		2000	
Insulation between open contacts					
Type of disconnection		Micro-disconnection		Micro-disconnection	
Dielectric strength	V AC/kV (1.2/50 μs)	1000/1.5		1000/1.5	
Insulation between coil terminals					
Rated impulse voltage (surge) differential mode (according to EN 61000-4-5)	kV(1.2/50 μs)	4			
Other data					
Bounce time: NO/NC	ms	1/4			
Vibration resistance (5...55)Hz: NO/NC	g	22/22			
Shock resistance	g	20			
Power lost to the environment	without contact current	W	1.3		1.3
	with rated current	W	2.7 (60.12, 60.62)		3.4 (60.13, 60.63)

Contact specification

F 60 -Electrical life (AC) v contact current

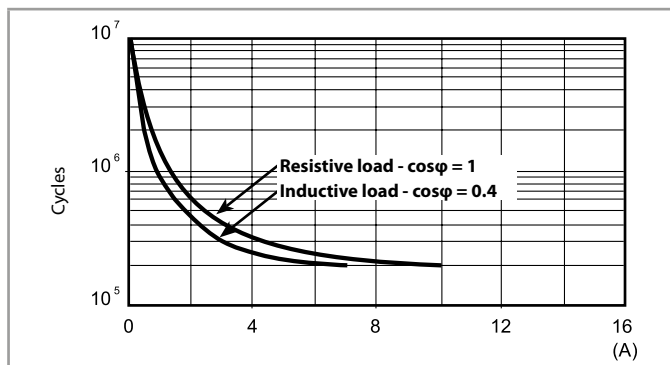

H 60 -Maximum DC1 breaking capacity

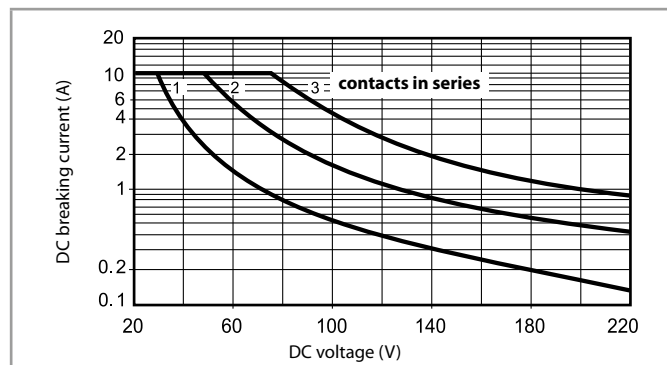

- When switching a resistive load (DC1) having voltage and current values under the curve, an electrical life of $\geq 100 \cdot 10^3$ can be expected.
 - In the case of DC13 loads, the connection of a diode in parallel with the load will permit a similar electrical life as for a DC1 load.
- Note: the release time for the load will be increased.

Coil specifications

DC coil data

Nominal voltage U_N V	Coil code	Operating range		Resistance R Ω	Rated coil absorption I at U_N mA
		U_{min} V	U_{max} V		
6	9.006	4.8	6.6	28	214
12	9.012	9.6	13.2	110	109
24	9.024	19.2	26.4	445	53.9
48	9.048	38.4	52.8	1770	27.1
60	9.060	48	66	2760	21.7
110	9.110	88	121	9420	11.7
125	9.125	100	138	12000	10.4
220	9.220	176	242	37300	5.8

AC coil data

Nominal voltage U_N V	Coil code	Operating range		Resistance R Ω	Rated coil absorption I at U_N (50Hz) mA
		U_{min} V	U_{max} V		
6	8.006	4.8	6.6	4.6	367
12	8.012	9.6	13.2	19	183
24	8.024	19.2	26.4	74	90
48	8.048	38.4	52.8	290	47
60	8.060	48	66	450	37
110	8.110	88	121	1600	20
120	8.120	96	132	1940	18.6
230	8.230	184	253	7250	10.5
240	8.240	192	264	8500	9.2
400	8.400	320	440	19800	6

Coil specifications

R 60 - DC coil operating range v ambient temperature

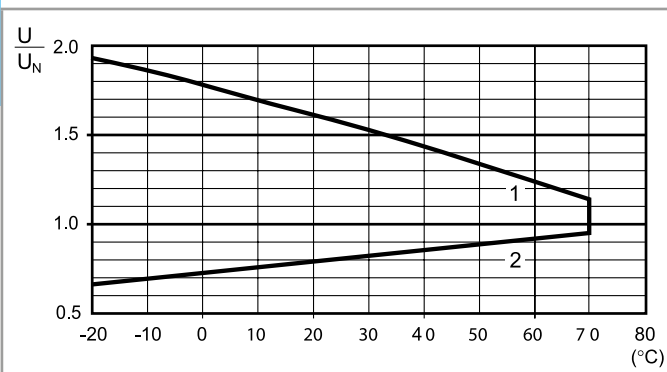

- 1 - Max. permitted coil voltage.
- 2 - Min. pick-up voltage with coil at ambient temperature.

R 60 - AC coil operating range v ambient temperature

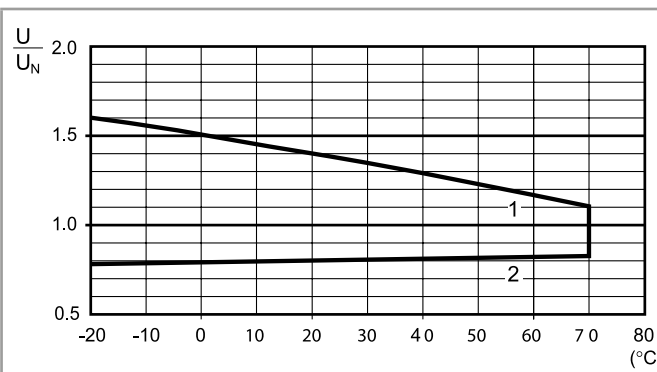

- 1 - Max. permitted coil voltage.
- 2 - Min. pick-up voltage with coil at ambient temperature.

Current sensing version

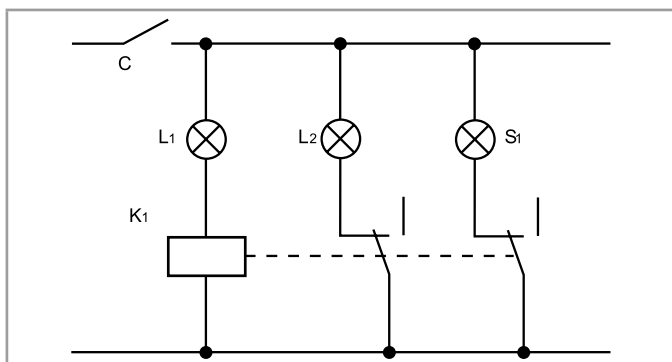

Typical application with current sensing relays.
An open circuit filament of lamp L_1 is detected by the current sensing relay coil (K_1) which causes the back-up safety lamp L_2 to be energised, and indication of failure at the control panel via lamp S_1 .
Example: navigation light.
 L_1 = Light
 L_2 = Safety light
 S_1 = Control light
 K_1 = Relay

Current sensing DC coil data

Coil code	I_{min} (A)	I_N (A)	I_{max} (A)	R (Ω)
4202	1.7	2.0	2.4	0.15
4182	1.5	1.8	2.2	0.19
4162	1.4	1.6	1.9	0.24
4142	1.2	1.4	1.7	0.31
4122	1.0	1.2	1.4	0.42
4102	0.85	1.0	1.2	0.61
4092	0.8	0.9	1.1	0.75
4062	0.5	0.6	0.7	1.70
4032	0.25	0.3	0.4	6.70
4012	0.085	0.1	0.15	61

Current sensing AC coil data

Coil code	I_{min} (A)	I_N (A)	I_{max} (A)	R (Ω)
4251	2.1	2.5	3.0	0.05
4181	1.5	1.8	2.2	0.10
4161	1.4	1.6	1.9	0.12
4121	1.0	1.2	1.4	0.22
4101	0.85	1.0	1.2	0.32
4051	0.42	0.5	0.6	1.28
4041	0.34	0.4	0.5	2.00
4031	0.25	0.3	0.4	3.57
4021	0.17	0.2	0.25	8.0
4011	0.085	0.1	0.15	32.1

Other types of current sensing relays are available on request.

Outline drawings

Type 60.12/60.12 - 52xx

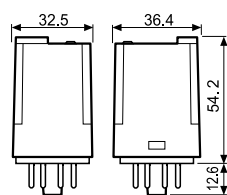

Type 60.13/60.13 - 52xx

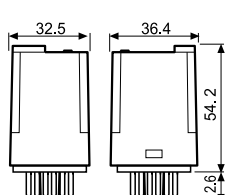

Type 60.62

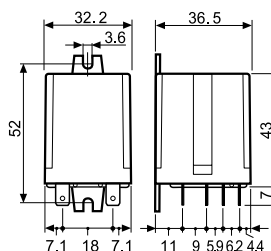

Type 60.63

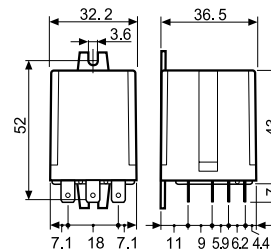

Accessories



Module	Socket	Relay	Description	Mounting	Accessories
99.02	90.02	60.12	Screw terminal (Box clamp) socket Double A1 terminal	Panel or 35 mm rail (EN 60715) mount	<ul style="list-style-type: none"> - Coil indication and EMC suppression modules - Jumper link - Timer modules - Metal retaining clip
	90.03	60.13			

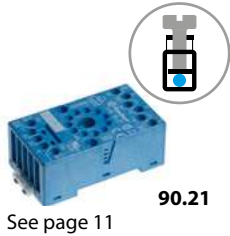

Module	Socket	Relay	Description	Mounting	Accessories
99.01	90.20	60.12	Screw terminal (Box clamp) socket	Panel or 35 mm rail (EN 60715) mount	<ul style="list-style-type: none"> - Coil indication and EMC suppression modules - Metal retaining clip
	90.21	60.13			

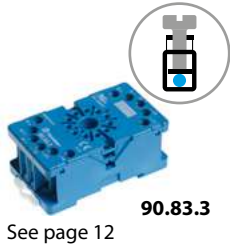

Module	Socket	Relay	Description	Mounting	Accessories
—	90.82.3	60.12	Screw terminal (Box clamp) socket	Panel or 35 mm rail (EN 60715) mount	- Metal retaining clip
—	90.83.3	60.13			



Module	Socket	Relay	Description	Mounting	Accessories
—	90.22	60.12	Screw terminal (Box clamp) socket	Panel or 35 mm rail (EN 60715) mount	- Metal retaining clip
—	90.23	60.13			

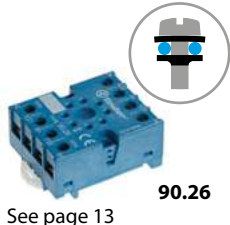

Module	Socket	Relay	Description	Mounting	Accessories
—	90.26	60.12	Screw terminal (Plate clamp) socket	Panel or 35 mm rail (EN 60715) mount	- Metal retaining clip
—	90.27	60.13			



Module	Socket	Relay	Description	Mounting	Accessories
—	90.12	60.12	Flange mount solder socket	M3 screw fixing	—
—	90.13	60.13			



Module	Socket	Relay	Description	Mounting	Accessories
—	90.14	60.12	PCB socket	PCB	—
—	90.14.1	60.12			
—	90.15	60.13			
—	90.15.1	60.13			

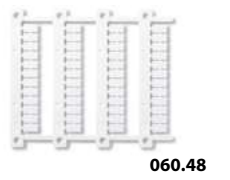

Sheet of marker tags (CEMBRE Thermal transfer printers) for relay types 60.12 and 60.13, plastic, 48 tags, 6 x 12 mm	060.48
--	--------

A



90.03

Approvals
(according to type):



UL US Certain relay/socket combinations

Screw terminal (Box clamp) socket panel or 35 mm rail (EN 60715) mount	90.02 Blue	90.02.0 Black	90.03 Blue	90.03.0 Black
For relay type	60.12		60.13	
Accessories				
Metal retaining clip			090.33	
6-way jumper link			090.06	
Identification tag			090.00.2	
Modules (see table below)			99.02	
Timer modules (see table below)			86.00, 86.30	
Technical data				
Rated values	10 A - 250 V			
Dielectric strength	2 kV AC			
Protection category	IP 20			
Ambient temperature	°C -40...+70			
Screw torque	Nm 0.6			
Wire strip length	mm 10			
Max. wire size for 90.02 and 90.03 sockets	solid wire		stranded wire	
	mm ² 1 x 6 / 2 x 2.5		1 x 4 / 2 x 2.5	
	AWG 1 x 10 / 2 x 14		1 x 12 / 2 x 14	

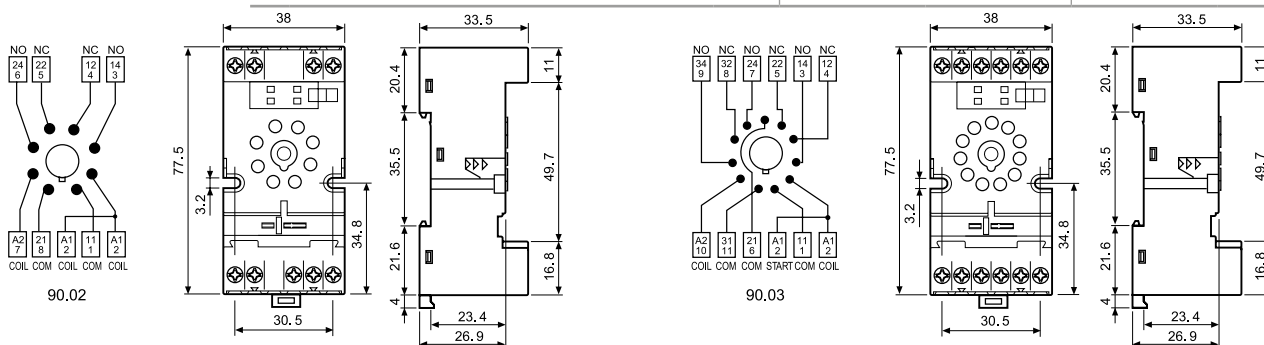

6-way jumper link for 90.02 and 90.03 sockets	090.06 (blue)	090.06.0 (black)
Rated values	10 A - 250 V	
Approvals (according to type):	EAC cRU US	

090.06



86.00



86.30



99.02

Approvals
(according to type):



DC Modules with non-standard polarity (+A2) on request.

86 series timer modules		
Multi-voltage: (12...240)V AC/DC; Multi-functions: AI, DI, SW, BE, CE, DE, EE, FE; (0.05 s...100 h)		86.00.0.240.0000
(12...24)V AC/DC; Bi-function: AI, DI; (0.05 s...100 h)		86.30.0.024.0000
(110...125)V AC; Bi-function: AI, DI; (0.05 s...100 h)		86.30.8.120.0000
(230...240)V AC; Bi-function: AI, DI; (0.05 s...100 h)		86.30.8.240.0000

Approvals (according to type): EAC cRU US		
99.02 coil indication and EMC suppression modules for 90.02 and 90.03 sockets		
Diode (+A1, standard polarity)	(6...220)V DC	99.02.3.000.00
LED	(6...24)V DC/AC	99.02.0.024.59
LED	(28...60)V DC/AC	99.02.0.060.59
LED	(110...240)V DC/AC	99.02.0.230.59
LED + Diode (+A1, standard polarity)	(6...24)V DC	99.02.9.024.99
LED + Diode (+A1, standard polarity)	(28...60)V DC	99.02.9.060.99
LED + Diode (+A1, standard polarity)	(110...220)V DC	99.02.9.220.99
LED + Varistor	(6...24)V DC/AC	99.02.0.024.98
LED + Varistor	(28...60)V DC/AC	99.02.0.060.98
LED + Varistor	(110...240)V DC/AC	99.02.0.230.98
RC circuit	(6...24)V DC/AC	99.02.0.024.09
RC circuit	(28...60)V DC/AC	99.02.0.060.09
RC circuit	(110...240)V DC/AC	99.02.0.230.09
Residual current by-pass	(110...240)V AC	99.02.8.230.07



90.21

Approvals
(according to type):



Screw terminal (Box clamp) socket panel or 35 mm rail (EN 60715) mount	90.20 Blue	90.20.0 Black	90.21 Blue	90.21.0 Black
For relay type	60.12		60.13	
Accessories				
Metal retaining clip (supplied with socket - packaging code SMA)			090.33	
Modules (see table below)			99.01	
Technical data				
Rated values	10 A - 250 V			
Dielectric strength	2 kV AC			
Protection category	IP 20			
Ambient temperature	°C -40...+70			
Screw torque	Nm 0.5			
Wire strip length	mm 10			
Max. wire size for 90.20 and 90.21 sockets	solid wire		stranded wire	
	mm ²	1 x 6 / 2 x 2.5		1 x 6 / 2 x 2.5
	AWG	1 x 10 / 2 x 14		1 x 10 / 2 x 14

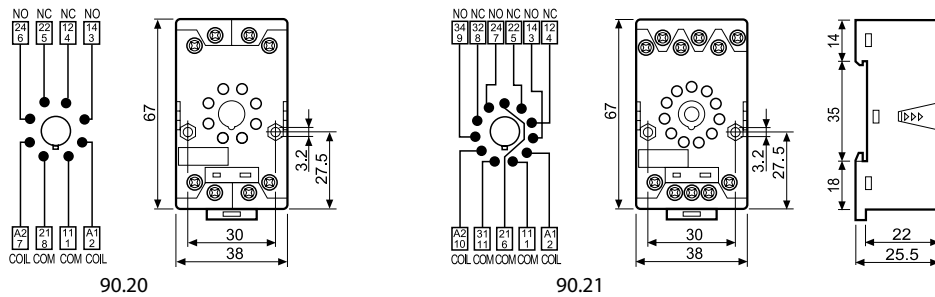

99.01

Approvals
(according to type):



* Modules in Black housing are available on request.

Green LED is standard.
Red LED available on request.

99.01 coil indication and EMC suppression modules for 90.20 and 90.21 sockets		Blue*
Diode (+A1, standard polarity)	(6...220)V DC	99.01.3.000.00
Diode (+A2, non-standard polarity)	(6...220)V DC	99.01.2.000.00
LED	(6...24)V DC/AC	99.01.0.024.59
LED	(28...60)V DC/AC	99.01.0.060.59
LED	(110...240)V DC/AC	99.01.0.230.59
LED + Diode (+A1, standard polarity)	(6...24)V DC	99.01.9.024.99
LED + Diode (+A1, standard polarity)	(28...60)V DC	99.01.9.060.99
LED + Diode (+A1, standard polarity)	(110...220)V DC	99.01.9.220.99
LED + Diode (+A2, non-standard polarity)	(6...24)V DC	99.01.9.024.79
LED + Diode (+A2, non-standard polarity)	(28...60)V DC	99.01.9.060.79
LED + Diode (+A2, non-standard polarity)	(110...220)V DC	99.01.9.220.79
LED + Varistor	(6...24)V DC/AC	99.01.0.024.98
LED + Varistor	(28...60)V DC/AC	99.01.0.060.98
LED + Varistor	(110...240)V DC/AC	99.01.0.230.98
RC circuit	(6...24)V DC/AC	99.01.0.024.09
RC circuit	(28...60)V DC/AC	99.01.0.060.09
RC circuit	(110...240)V DC/AC	99.01.0.230.09
Residual current by-pass	(110...240)V AC	99.01.8.230.07

A



90.83.3

Approvals
(according to type):



Screw terminal (Box clamp) socket panel or 35 mm rail (EN 60715) mount	90.82.3 Blue	90.82.30 Black	90.83.3 Blue	90.83.30 Black
For relay type	60.12		60.13	
Accessories				
Metal retaining clip	090.33			
Technical data				
Rated values	10 A - 250 V			
Dielectric strength	2 kV AC			
Protection category	IP 20			
Ambient temperature	°C -40...+70			
Screw torque	Nm 0.8			
Max. wire size for 90.82.3 and 90.83.3 sockets	solid wire		stranded wire	
	mm ²	1 x 6 / 2 x 4	1 x 6 / 2 x 4	
	AWG	1 x 10 / 2 x 14	1 x 10 / 2 x 14	

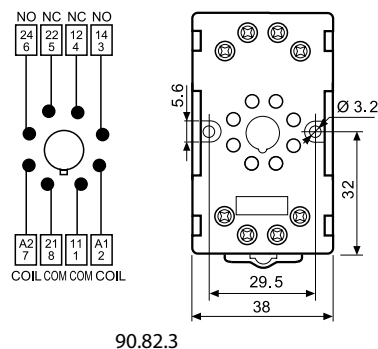

90.82.3

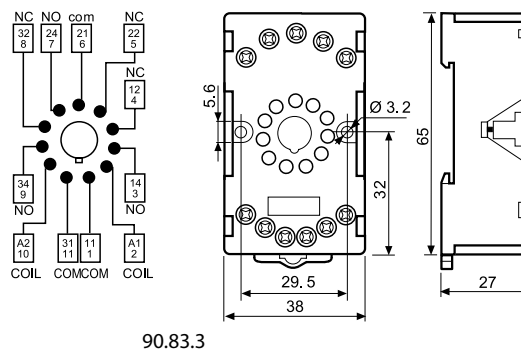

90.83.3



90.23

Approvals
(according to type):



Screw terminal (Box clamp) socket panel or 35 mm rail (EN 60715) mount	90.22 Blue	90.23 Blue
For relay type	60.12	60.13
Accessories		
Metal retaining clip (supplied with socket - packaging code SMA)	090.33	
Technical data		
Rated values	10 A - 250 V	
Dielectric strength	2 kV AC	
Protection category	IP 20	
Ambient temperature	°C -40...+70	
Screw torque	Nm 0.5	
Wire strip length	mm 7	
Max. wire size for 90.22 and 90.23 sockets	solid wire	
	mm ²	1 x 6 / 2 x 2.5
	AWG	1 x 10 / 2 x 14

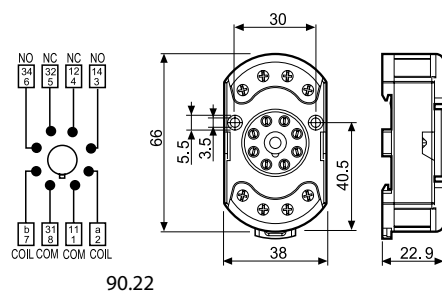

90.22

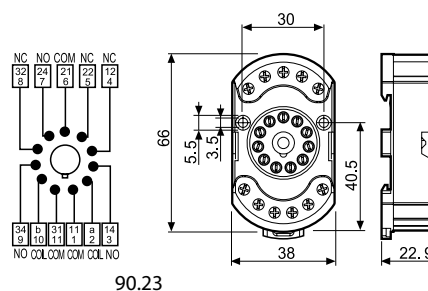

90.23

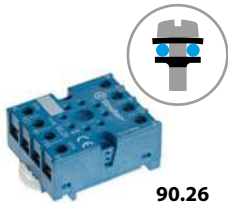

90.26

Approvals
(according to type):



Screw terminal (Box clamp) socket	90.26	90.26.0	90.27	90.27.0
panel or 35 mm rail (EN 60715) mount	Blue	Black	Blue	Black
For relay type	60.12		60.13	
Accessories				
Metal retaining clip (supplied with socket - packaging code SMA)			090.33	
Technical data				
Rated values	10 A - 250 V			
Dielectric strength	2 kV AC			
Protection category	IP 20			
Ambient temperature	°C -40...+70			
Screw torque	Nm 0.8			
Wire strip length	mm 10			
Max. wire size for 90.26 and 90.27 sockets	solid wire		stranded wire	
	mm ²	1 x 4 / 2 x 2.5		1 x 4 / 2 x 2.5
	AWG	1 x 12 / 2 x 14		1 x 12 / 2 x 14

A

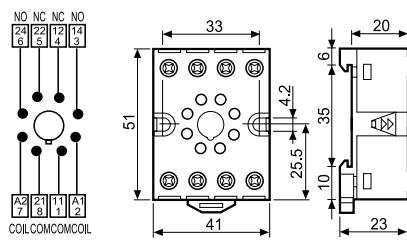

90.26

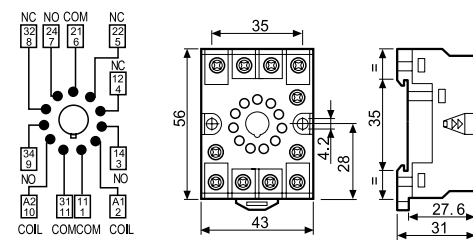

90.27



90.12

Approvals
(according to type):



Flange mount solder socket	90.12 (black)	90.13 (black)
mount with M3 screw		
For relay type	60.12	60.13
Technical data		
Rated values	10 A - 250 V	
Dielectric strength	2 kV AC	
Ambient temperature	°C -40...+70	

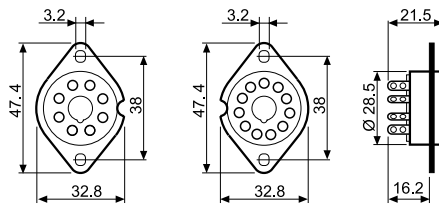

90.12

90.13



90.15

A

Approvals
(according to type):



PCB socket	Blue	90.14 (Ø 20.5 mm)	90.15 (Ø 22 mm)
	Blue	90.14.1 (Ø 17.5 mm)	90.15.1 (Ø 19 mm)
For relay type		60.12	60.13
Technical data			
Rated values		10 A - 250 V	
Dielectric strength		2 kV AC	
Ambient temperature	°C	-40...+70	

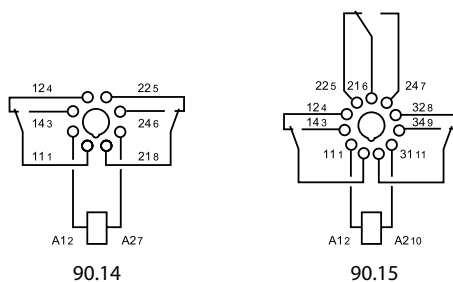
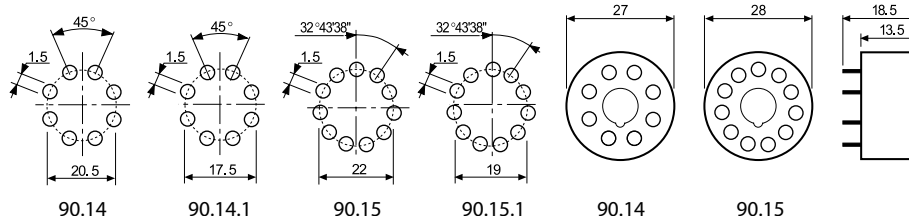

Packaging codes

How to code and identify retaining clip and packaging options for sockets.

Example:

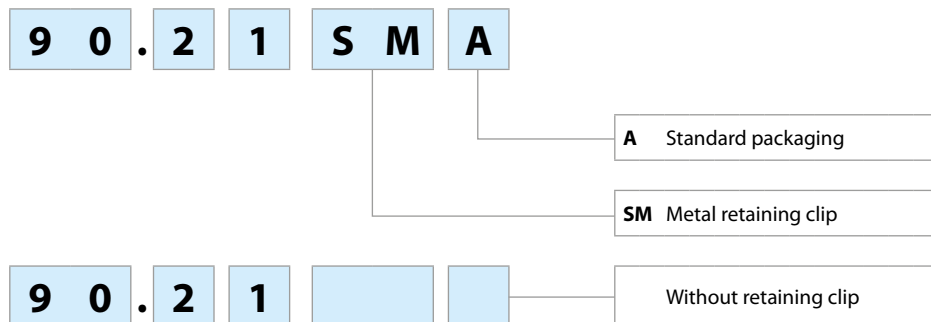



Power relays 16 A



Road / tunnel lighting



Industrial furnaces and ovens



Burners, boilers and furnaces



Control and management of electric power



Punches, cleaners, planers and sanders



Control panels



Circuit breakers and switches



Industrial motors

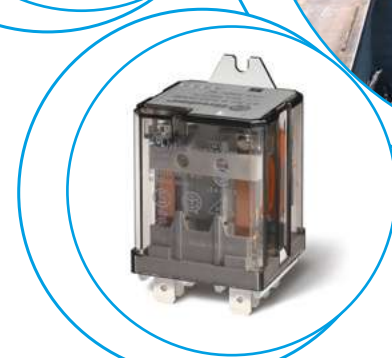
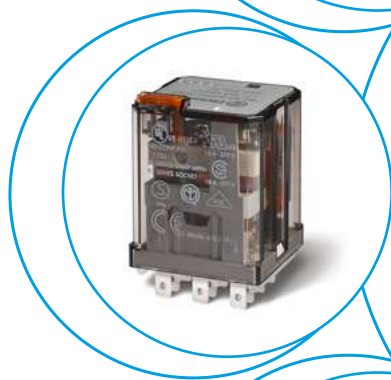

**Printed circuit mount
16 A Power relay**

- 2 & 3 Pole changeover contacts or NO (≥ 3 mm contact gap)
- AC coils & DC coils
- Reinforced insulation between coil and contacts according to EN 60335-1, with 6 mm clearance & 8 mm creepage distance
- SELV coil-contact separator option
- Cadmium free contact material options

* Distance between contacts ≥ 3 mm (EN 60730-1).
 ** With the AgSnO₂ material the maximum peak current is 120 A - 5 ms (NO contact).

FOR UL RATINGS SEE:
 "General technical information" page V

For outline drawing see page 12

Contact specification

Contact configuration	2 CO (DPDT)	3 CO (3PDT)	2 NO (DPST-NO), ≥ 3 mm*	3 NO (3PST-NO), ≥ 3 mm*
Rated current/Maximum peak current	A 16/30**		16/30**	
Rated voltage/ Maximum switching voltage	V AC 250/400		250/400	
Rated load AC1	VA 4000		4000	
Rated load AC15 (230 V AC)	VA 750		750	
Motor rating (230/400 V AC)	kW 0.8/—	0.8/1.5	0.8/—	0.8/1.5
Breaking capacity DC1: 30/110/220 V	A 16/0.6/0.4		16/1.1/0.7	
Minimum switching load	mW (V/mA) 1000 (10/10)		1000 (10/10)	
Standard contact material	AgCdO		AgCdO	

Coil specification

Nominal voltage (U _N)	V AC (50/60 Hz)	6 - 12 - 24 - 48 - 60 - 110 - 120 - 230 - 240 - 400		
	V DC	6 - 12 - 24 - 48 - 60 - 110 - 125 - 220		
Rated power AC/DC	VA (50 Hz)/W	2.2/1.3		3/3
Operating range	AC	(0.8...1.1)U _N		(0.85...1.1)U _N
	DC	(0.8...1.1)U _N		(0.85...1.1)U _N
Holding voltage	AC/DC	0.8 U _N / 0.6 U _N		0.8 U _N / 0.6 U _N
Must drop-out voltage	AC/DC	0.2 U _N / 0.1 U _N		0.2 U _N / 0.1 U _N

Technical data

Mechanical life AC/DC	cycles	10 · 10 ⁶ /30 · 10 ⁶		10 · 10 ⁶ /30 · 10 ⁶
Electrical life at rated load AC1	cycles	100 · 10 ³		100 · 10 ³
Operate/release time	ms	11/4		15/3
Insulation between coil and contacts (1.2/50 µs)	kV	6		6
Dielectric strength between open contacts	V AC	1500		3000
Ambient temperature range	°C	-40...+70		-40...+50
Environmental protection		RT I		RT I

Approvals (according to type)



62.22/62.23



- 2 & 3 pole changeover contact
- PCB mount

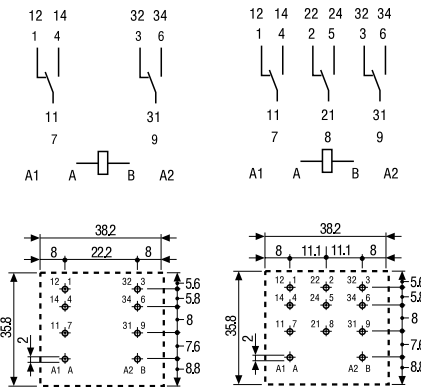

62.22
Copper side view

62.23
Copper side view

62.22-0300/62.23-0300



- 2 & 3 pole normally open contact (≥ 3 mm contact gap)
- PCB mount

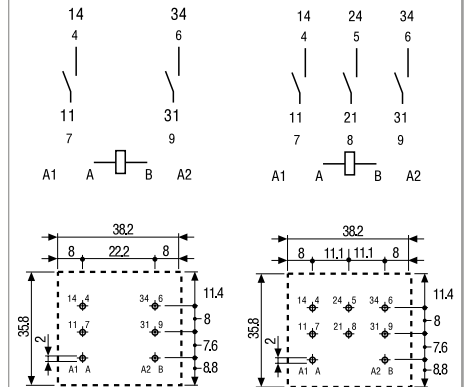

62.22 - 0300
Copper side view

62.23 - 0300
Copper side view

Plug-in mount/Faston 187**16 A Power relay**

- Plug-in (92 series sockets) or Faston 187 (4.8 x 0.5 mm) with optional mounting adaptors
- 2 & 3 Pole changeover contacts or NO (≥ 3 mm contact gap)
- AC coils & DC coils
- UL Listing (certain relay/socket combinations)
- LED, mechanical indicator & test button options
- Reinforced insulation between coil and contacts according to EN 60335-1, with 6 mm clearance & 8 mm creepage distance
- SELV coil-contact separator option
- Cadmium free contact material options
- Sockets and accessories
- European Patent

- * Distance between contacts ≥ 3 mm (EN 60730-1).
- ** With the AgSnO_2 material the maximum peak current is 120 A - 5 ms (NO contact).

FOR UL RATINGS SEE:

"General technical information" page V

For outline drawing see page 12

Contact specification

Contact configuration	2 CO (DPDT)	3 CO (3PDT)	2 NO (DPST-NO), ≥ 3 mm*	3 NO (3PST-NO), ≥ 3 mm*
Rated current/Maximum peak current	A 16/30**		16/30**	
Rated voltage/Maximum switching voltage	V AC 250/400		250/400	
Rated load AC1	VA 4000		4000	
Rated load AC15 (230 V AC)	VA 750		750	
Motor rating (230/400 V AC)	kW 0.8/—	0.8/1.5	0.8/—	0.8/1.5
Breaking capacity DC1: 30/110/220 V	A 16/0.6/0.4		16/1.1/0.7	
Minimum switching load	mW (V/mA) 1000 (10/10)		1000 (10/10)	
Standard contact material	AgCdO		AgCdO	

Coil specification

Nominal voltage (U_N)	V AC (50/60 Hz)	6 - 12 - 24 - 48 - 60 - 110 - 120 - 230 - 240 - 400	
	V DC	6 - 12 - 24 - 48 - 60 - 110 - 125 - 220	
Rated power AC/DC	VA (50 Hz)/W	2.2/1.3	
Operating range	AC	$(0.8 \dots 1.1) U_N$	
	DC	$(0.85 \dots 1.1) U_N$	
Holding voltage	AC/DC	$0.8 U_N / 0.6 U_N$	
Must drop-out voltage	AC/DC	$0.2 U_N / 0.1 U_N$	

Technical data

Mechanical life AC/DC	cycles	$10 \cdot 10^6 / 30 \cdot 10^6$	
Electrical life at rated load AC1	cycles	$100 \cdot 10^3$	
Operate/release time	ms	11/4	
Insulation between coil and contacts (1.2/50 μs)	kV	6	
Dielectric strength between open contacts	V AC	1500	
Ambient temperature range	$^{\circ}\text{C}$	-40...+70	
Environmental protection		RT I	

Approvals (according to type)

**62.32/62.33**

- 2 & 3 pole changeover contact
- Plug-in/Faston 187

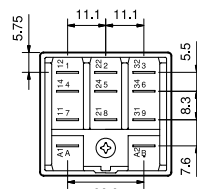
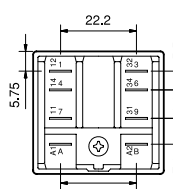
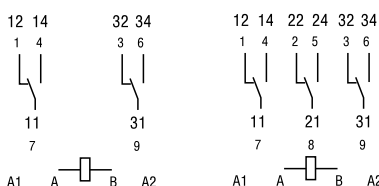

62.32

62.33

62.32-0300/62.33-0300

- 2 & 3 pole normally open contact (≥ 3 mm contact gap)
- Plug-in/Faston 187

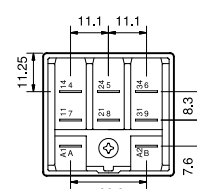
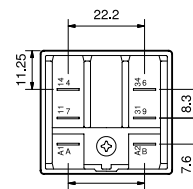
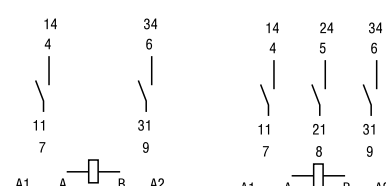

62.32-0300

62.33-0300

**Flange mount/Faston 250
16 A Power relay**

- Faston 250 (6.3 x 0.8 mm) termination Flange or optional mounting adaptors
- 2 & 3 Pole changeover contacts or NO (≥ 3 mm contact gap)
- AC coils & DC coils
- LED, mechanical indicator & test button options
- Reinforced insulation between coil and contacts according to EN 60335-1, with 6 mm clearance & 8 mm creepage distance
- SELV coil-contact separator option
- Cadmium free contact material options
- European Patent

62.82/62.83



- 2 & 3 pole changeover contact
- Flange mount/Faston 250

62.82-0300/62.83-0300



- 2 & 3 pole normally open contact (≥ 3 mm contact gap)
- Flange mount/Faston 250

* Distance between contacts ≥ 3 mm (EN 60730-1).
** With the AgSnO₂ material the maximum peak current is 120 A - 5 ms (NO contact).

FOR UL RATINGS SEE:
"General technical information" page V
For outline drawing see page 12

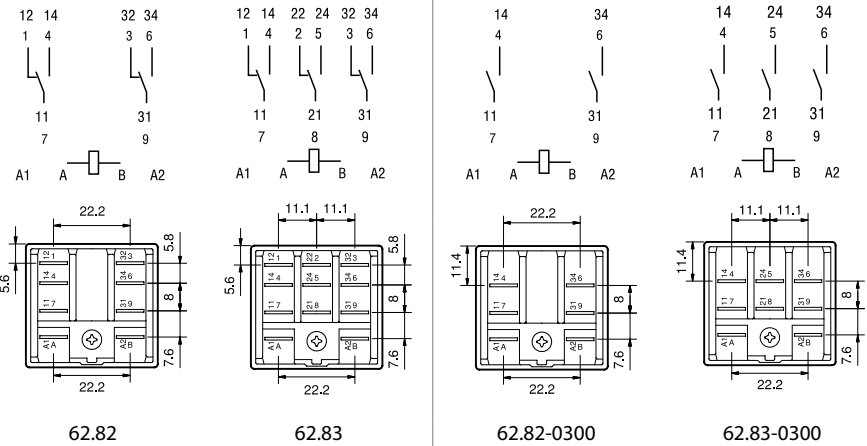

Contact specification

Contact configuration		2 CO (DPDT)	3 CO (3PDT)	2 NO (DPST-NO), ≥ 3 mm*	3 NO (3PST-NO), ≥ 3 mm*
Rated current/Maximum peak current	A	16/30**		16/30**	
Rated voltage/ Maximum switching voltage	V AC	250/400		250/400	
Rated load AC1	VA	4000		4000	
Rated load AC15 (230 V AC)	VA	750		750	
Motor rating (230/400 V AC)	kW	0.8/—	0.8/1.5	0.8/—	0.8/1.5
Breaking capacity DC1: 30/110/220 V	A	16/0.6/0.4		16/1.1/0.7	
Minimum switching load	mW (V/mA)	1000 (10/10)		1000 (10/10)	
Standard contact material		AgCdO		AgCdO	

Coil specification

Nominal voltage (U _N)	V AC (50/60 Hz)	6 - 12 - 24 - 48 - 60 - 110 - 120 - 230 - 240 - 400			
	V DC	6 - 12 - 24 - 48 - 60 - 110 - 125 - 220			
Rated power AC/DC	VA (50 Hz)/W	2.2/1.3		3/3	
Operating range	AC	(0.8...1.1)U _N		(0.85...1.1)U _N	
	DC	(0.8...1.1)U _N		(0.85...1.1)U _N	
Holding voltage	AC/DC	0.8 U _N / 0.6 U _N		0.8 U _N / 0.6 U _N	
Must drop-out voltage	AC/DC	0.2 U _N / 0.1 U _N		0.2 U _N / 0.1 U _N	

Technical data

Mechanical life AC/DC	cycles	10 · 10 ⁶ /30 · 10 ⁶		10 · 10 ⁶ /30 · 10 ⁶	
Electrical life at rated load AC1	cycles	100 · 10 ³		100 · 10 ³	
Operate/release time	ms	11/4		15/3	
Insulation between coil and contacts (1.2/50 μs)	kV	6		6	
Dielectric strength between open contacts	V AC	1500		3000	
Ambient temperature range	°C	-40...+70		-40...+50	
Environmental protection		RT I		RT I	

Approvals (according to type)



**Plug-in mount/Faston 187
Magnetic blow power relay**

- Plug-in (92 series sockets) or Faston 187 (4.8 x 0.5 mm) with optional mounting adaptors
- 1 & 2 Pole NO contacts
- High DC load (resistive and inductive) switching capability
- DC coils
- Reinforced insulation between coil and contacts according to EN 60335-1, with 6 mm clearance & 8 mm creepage distance
- Cadmium free contact material
- Sockets and accessories

NEW 62.31-4800



- 1 pole normally open contact (double break, ≥ 4.2 mm contact gap)
- Plug-in/Faston 187

NEW 62.32-4800

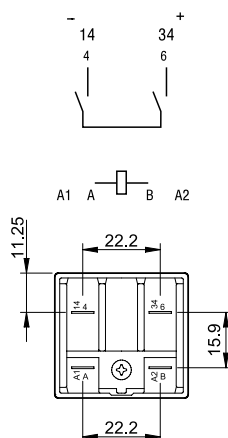
- 2 pole normally open contact (≥ 2.1 mm contact gap)
- Plug-in/Faston 187

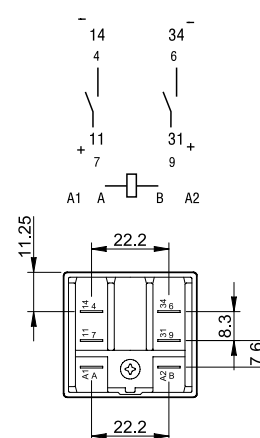

62.31-4800



62.32-4800

* Maximum peak current 120 A - 5 ms.

For outline drawing see page 12

Contact specification

Contact configuration	1 NO (SPST-NO) double break, ≥ 4.2 mm	2 NO (DPST-NO), ≥ 2.1 mm
Rated current/Maximum peak current	A	16/30*
Rated voltage/ Maximum switching voltage	V AC	250/400
Rated load AC1	VA	4000
Breaking capacity DC1: 30/125/220 V	A	16/16/12
Breaking capacity DC inductive (L/R = 40 ms): 30/125/220 V	A	16/5/3
Minimum switching load	mW (V/mA)	1000 (10/10)
Standard contact material	AgSnO ₂	AgSnO ₂

Coil specification

Nominal voltage (U _N)	V DC	6 - 12 - 24 - 48 - 60 - 110 - 125 - 220
Rated power DC	W	1.3
Operating range	DC	(0.85...1.1)U _N
Holding voltage	DC	0.6 U _N
Must drop-out voltage	DC	0.1 U _N

Technical data

Mechanical life DC	cycles	10 · 10 ⁶	10 · 10 ⁶
Electrical life at rated load DC1	cycles	100 · 10 ³	100 · 10 ³
Operate/release time	ms	16/5	16/5
Insulation between coil and contacts (1.2/50 μs)	kV	6	6
Dielectric strength between open contacts	V AC	3000	2000
Ambient temperature range	°C	-40...+70	-40...+70
Environmental protection		RT I	RT I

Approvals (according to type)

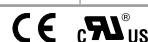

Ordering information

Example: 62 series power relay + Faston 250 (6.3 x 0.8 mm), rear flange mount, 2 NO (DPST-NO), 12 V DC coil.

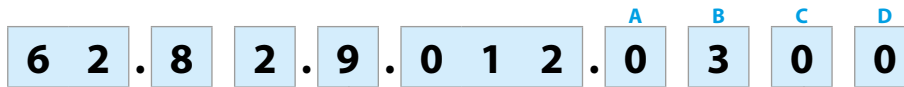

- Series**
- Type**
2 = PCB
3 = Plug-in
8 = Faston 250 (6.3 x 0.8 mm) with rear flange mount
- No. of poles**
1 = 1 pole (double break)
2 = 2 pole
3 = 3 pole
- Coil version**
8 = AC (50/60 Hz)
9 = DC
- Coil voltage**
See coil specifications

- A: Contact material**
0 = Standard AgCdO
4 = AgSnO₂ (standard for versions 4800)
- B: Contact circuit**
0 = CO (nPDT)
3 = NO (nPST), ≥ 3 mm contact gap
5 = CO (nPDT) + additional physical separator between coil and contacts (for SELV applications)
6 = NO (nPST), ≥ 3 mm contact gap + additional physical separator between coil and contacts (for SELV applications)
8 = NO (1 pole double break or 2 pole) with magnetic blow

- D: Special versions**
0 = Standard
6 = Rear flange mount
9 = Type 62.82/83 without rear flange mount
 - C: Options**
0 = None
2 = Mechanical indicator
3 = LED (AC)
4 = Lockable test button + mechanical indicator
5* = Lockable test button + LED (AC) (DC, polarity positive to pin A/A1)
54* = Lockable test button + LED (AC) + mechanical indicator
6* = LED + diode (DC, polarity positive to pin A/A1)
7* = Lockable test button + LED + diode (DC, polarity positive to pin A/A1)
74* = Lockable test button + LED + diode (DC, polarity positive to pin A/A1) + mechanical indicator
- * Options not available for 220 V DC and 400 V AC versions.

Selecting features and options: only combinations in the same row are possible.

Preferred selections for best availability are shown in **bold**.

Type	Coil version	A	B	C	D
62.22/23	AC-DC	0 - 4	0 - 3 - 5 - 6	0	0
62.32/33	AC-DC	0 - 4	0 - 3 - 5 - 6	0	0 - 6
	AC-DC	0 - 4	0 - 5	2 - 4	0 - 6
	AC	0 - 4	0	2 - 3 - 4 - 5	0 - 6
	AC	0 - 4	0 - 3	3	0 - 6
	AC	0 - 4	0	54	/
	DC	0 - 4	0	4 - 6 - 7	0 - 6
	DC	0 - 4	0 - 3	6	0 - 6
	DC	0 - 4	0	74	/
62.31/32	DC	4	8	0	0
62.82/83	AC-DC	0 - 4	0 - 3 - 5 - 6	0	0 - 9
	AC-DC	0 - 4	0 - 5	2 - 4	0
	AC	0 - 4	0	2 - 3 - 4 - 5	0
	AC	0 - 4	0 - 3	3	0
	DC	0 - 4	0	4 - 6 - 7	0
DC	0 - 4	0 - 3	6	0	

Descriptions: Options and Special versions

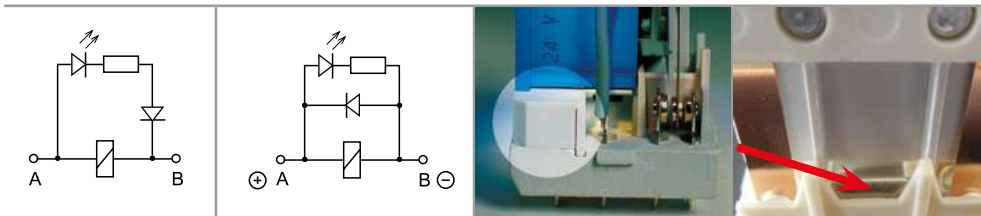

C: Option 3, 5, 54
LED (AC)

C: Option 6, 7, 74
LED + diode (DC, polarity positive to pin A/A1)

B: Contact circuit 5, 6
Additional physical separator between coil and contacts (for SELV applications)

B: Contact circuit 8
Magnetic blow



Lockable test button and mechanical flag indicator (0040, 0050, 0054, 0070, 0074)

The dual-purpose Finder test button can be used in two ways:

Case 1) The plastic pip (located directly above the test button) remains intact. In this case, when the test button is pushed, the contacts operate. When the test button is released the contacts return to their former state.

Case 2) The plastic pip is broken-off (using an appropriate cutting tool). In this case, (in addition to the above function), when the test button is pushed and rotated, the contacts are latched in the operating state, and remain so until the test button is rotated back to its former position. In both cases ensure that the test button actuation is swift and decisive.



Technical data

A

Insulation according to EN 61810-1								
		2 CO - 3 CO	2 NO - 3 NO	1 NO*	2 NO*			
Nominal voltage of supply system	V AC	230/400	230/400	230/400	230/400			
Rated insulation voltage	V AC	400	400	400	400			
Pollution degree		3	3	3	3			
Insulation between coil and contact set								
Type of insulation		Reinforced	Reinforced	Reinforced	Reinforced			
Overvoltage category		III	III	III	III			
Rated impulse voltage	kV (1.2/50 µs)	6	6	6	6			
Dielectric strength	V AC	4000	4000	4000	4000			
Insulation between adjacent contacts								
Type of insulation		Basic	Basic	—	Basic			
Overvoltage category		III	III	—	III			
Rated impulse voltage	kV (1.2/50 µs)	4	4	—	4			
Dielectric strength	V AC	2500	2500	—	2500			
Insulation between open contacts								
Type of disconnection		Micro-disconnection	Full-disconnection	Full-disconnection	Full-disconnection**			
Overvoltage category		—	III	III	II			
Rated impulse voltage	kV (1.2/50 µs)	—	4	4	2.5			
Dielectric strength	V AC/kV (1.2/50 µs)	1500/2	3000/4	3000/4	2000/2.5			
Conducted disturbance immunity								
Burst (5...50)ns, 5 kHz, on A1 - A2 according to EN 61000-4-4		level 4 (4 kV)						
Surge (1.2/50 µs) on A1 - A2 (differential mode) according to EN 61000-4-5		level 4 (4 kV)						
Other data								
Bounce time: NO/NC	ms	1/5 (changeover)	3/— (normally open)	3/— (normally open)	3/— (normally open)			
Vibration resistance (10...150)Hz: NO/NC	g	20/8						
Shock resistance	g	15						
Power lost to the environment		2 pole (CO)	3 pole (CO)	2 pole (NO)	3 pole (NO)	1 pole (NO)*	2 pole (NO)*	
	without contact current	W	1.3	1.3	3	3	1.3	1.3
	with rated current	W	3.3	4.3	5	6	3	3.3
Recommended distance between relays mounted on PCB	mm	≥ 5				—		

* Magnetic blow version

** Only in applications where over voltage category II is permitted. In applications of over voltage category III: Micro-disconnection.

Contact specification

F 62 - Electrical life (AC) v contact current

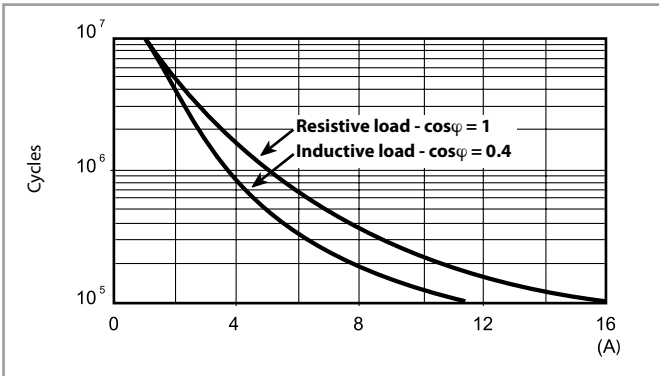

H 62 - Maximum DC1 breaking capacity

Changeover contacts

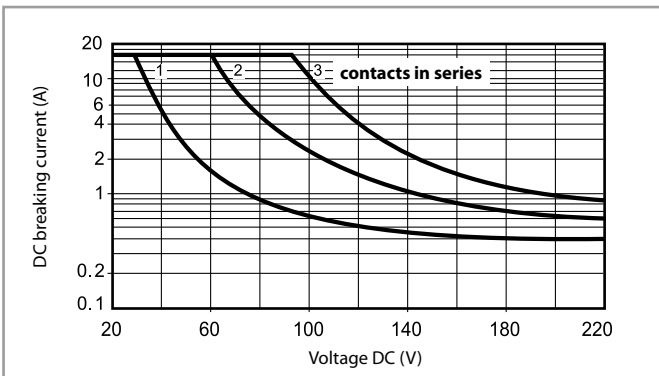

H 62 - Maximum DC1 breaking capacity

Normally open contacts

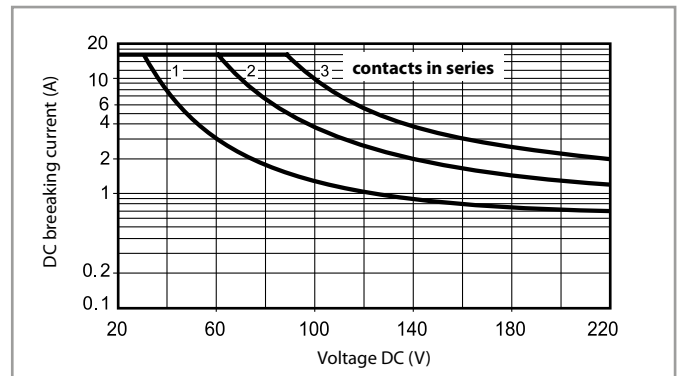

- When switching a resistive load (DC1) having voltage and current values under the curve, an electrical life of $\geq 100 \cdot 10^3$ can be expected.
- In the case of DC13 loads, the connection of a diode in parallel with the load will permit a similar electrical life as for a DC1 load.
Note: the release time of the load will be increased.

H 62 - Maximum DC breaking capacity 62.31.9.xxx.4800

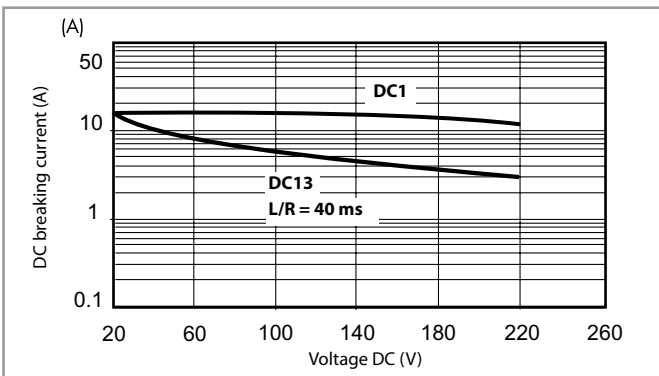

H 62 - Maximum DC breaking capacity 62.32.9.xxx.4800

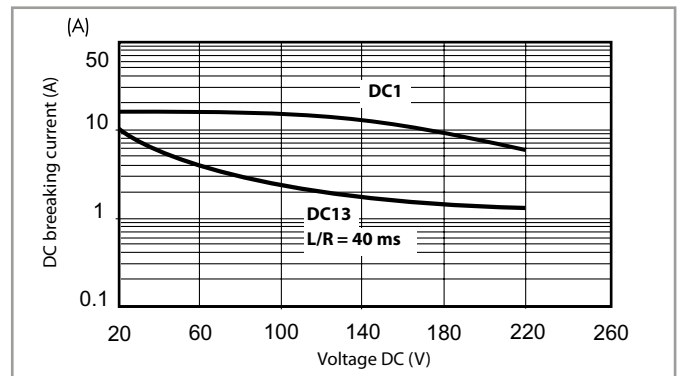

- When switching a resistive load (DC1), or a DC13 load with a diode in parallel to the load, having voltage and current values under the DC1 curve, an electrical life of $\geq 100 \cdot 10^3$ can be expected. Note: the release time for the load will be increased.
- When switching a DC13 load without a diode in parallel to the load, the DC13 curve applies and an electrical life of $\geq 80 \cdot 10^3$ can be expected.

Coil specifications

DC version data

Nominal voltage U_N	Coil code	Operating range		Resistance R	Rated coil consumption I at U_N
		U_{min}	U_{max}		
V		V	V	Ω	mA
6	9.006	4.8	6.6	28	214
12	9.012	9.6	13.2	110	109
24	9.024	19.2	26.4	445	54
48	9.048	38.4	52.8	1770	27
60	9.060	48	66	2760	21.7
110	9.110	88	121	9420	11.7
125	9.125	100	138	12000	10.4
220	9.220	176	242	37300	5.8

AC version data

Nominal voltage U_N	Coil code	Operating range		Resistance R	Rated coil consumption I at U_N (50Hz)
		U_{min}	U_{max}		
V		V	V	Ω	mA
6	8.006	4.8	6.6	4.6	367
12	8.012	9.6	13.2	19	183
24	8.024	19.2	26.4	74	90
48	8.048	38.4	52.8	290	47
60	8.060	48	66	450	37
110	8.110	88	121	1600	20
120	8.120	96	132	1940	18.6
230	8.230	184	253	7250	10.5
240	8.240	192	264	8500	9.2
400	8.400	320	440	19800	6

DC (NO/nPST-NO) version data - ≥ 3 mm

Nominal voltage U_N	Coil code	Operating range		Resistance R	Rated coil consumption I at U_N
		U_{min}	U_{max}		
V		V	V	Ω	mA
6	9.006	5.1	6.6	12	500
12	9.012	10.2	13.2	48	250
24	9.024	20.4	26.4	192	125
48	9.048	40.8	52.8	770	63
60	9.060	51	66	1200	50
110	9.110	93.5	121	4200	26
125	9.125	106	138	5200	24
220	9.220	187	242	17600	12.5

AC (NO/nPST-NO) version data - ≥ 3 mm

Nominal voltage U_N	Coil code	Operating range		Resistance R	Rated coil consumption I at U_N (50Hz)
		U_{min}	U_{max}		
V		V	V	Ω	mA
6	8.006	5.1	6.6	4	540
12	8.012	10.2	13.2	14	275
24	8.024	20.4	26.4	62	130
48	8.048	40.8	52.8	220	70
60	8.060	51	66	348	55
110	8.110	93.5	121	1200	30
120	8.120	106	137	1350	24
230	8.230	196	253	5000	14
240	8.240	204	264	6300	12.5
400	8.400	340	440	14700	7.8

DC (NO/nPST-NO) magnetic blow version - ≥ 2.1 mm or ≥ 4.2 mm

Nominal voltage U_N	Coil code	Operating range		Resistance R	Rated coil consumption I at U_N
		U_{min}	U_{max}		
V		V	V	Ω	mA
6	9.006	5.1	6.6	28	214
12	9.012	10.2	13.2	110	109
24	9.024	20.4	26.4	445	54
48	9.048	40.8	52.8	1770	27
60	9.060	51	66	2760	21.7
110	9.110	93.5	121	9420	11.7
125	9.125	106	138	12000	10.4
220	9.220	154*	242	37300	5.8

* Special version with $U_{min} = 70\% U_N$

Coil specifications

R 62 - DC coil operating range v ambient temperature
Changeover contacts

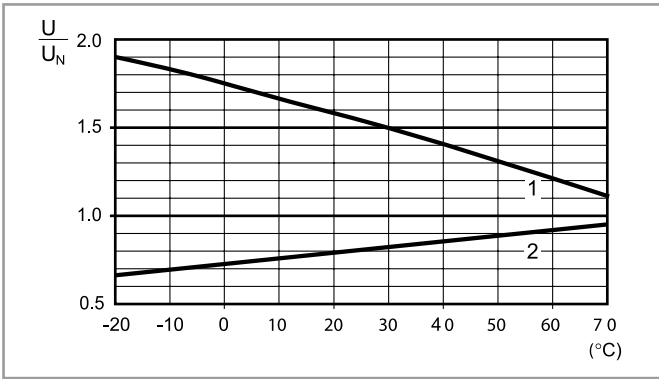

- 1 - Max. permitted coil voltage.
- 2 - Min. pick-up voltage with coil at ambient temperature.

R 62 - AC coil operating range v ambient temperature
Changeover contacts

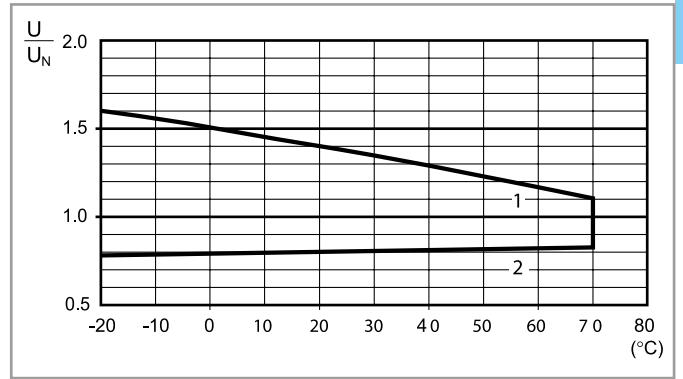

- 1 - Max. permitted coil voltage.
- 2 - Min. pick-up voltage with coil at ambient temperature.

R 62 - DC coil operating range v ambient temperature
Normally open contacts

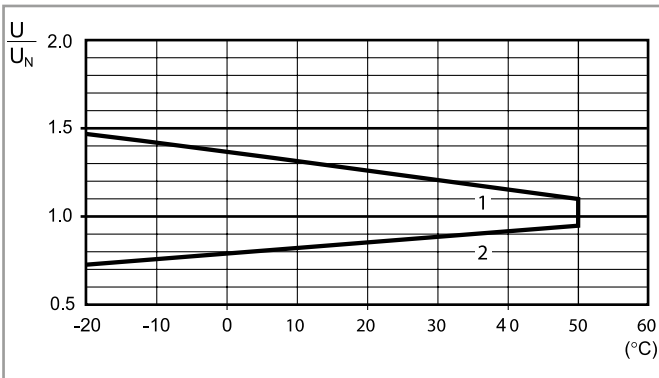

- 1 - Max. permitted coil voltage.
- 2 - Min. pick-up voltage with coil at ambient temperature.

R 62 - AC coil operating range v ambient temperature
Normally open contacts

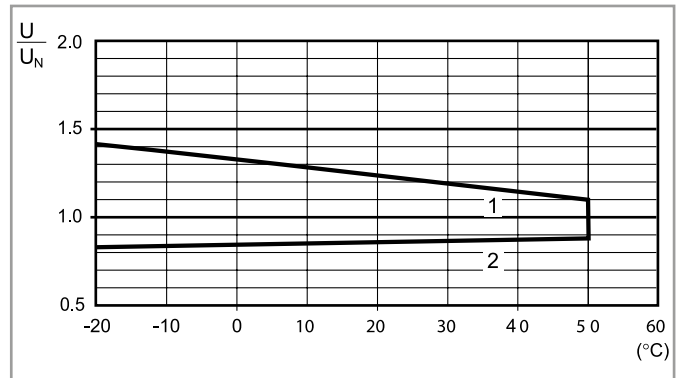

- 1 - Max. permitted coil voltage.
- 2 - Min. pick-up voltage with coil at ambient temperature.

R 62 - DC coil operating range v ambient temperature
Normally open contacts - magnetic blow version

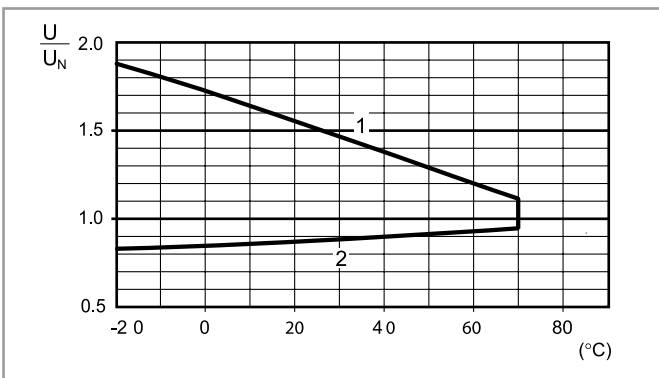

- 1 - Max. permitted coil voltage.
- 2 - Min. pick-up voltage with coil at ambient temperature.

Outline drawings

A

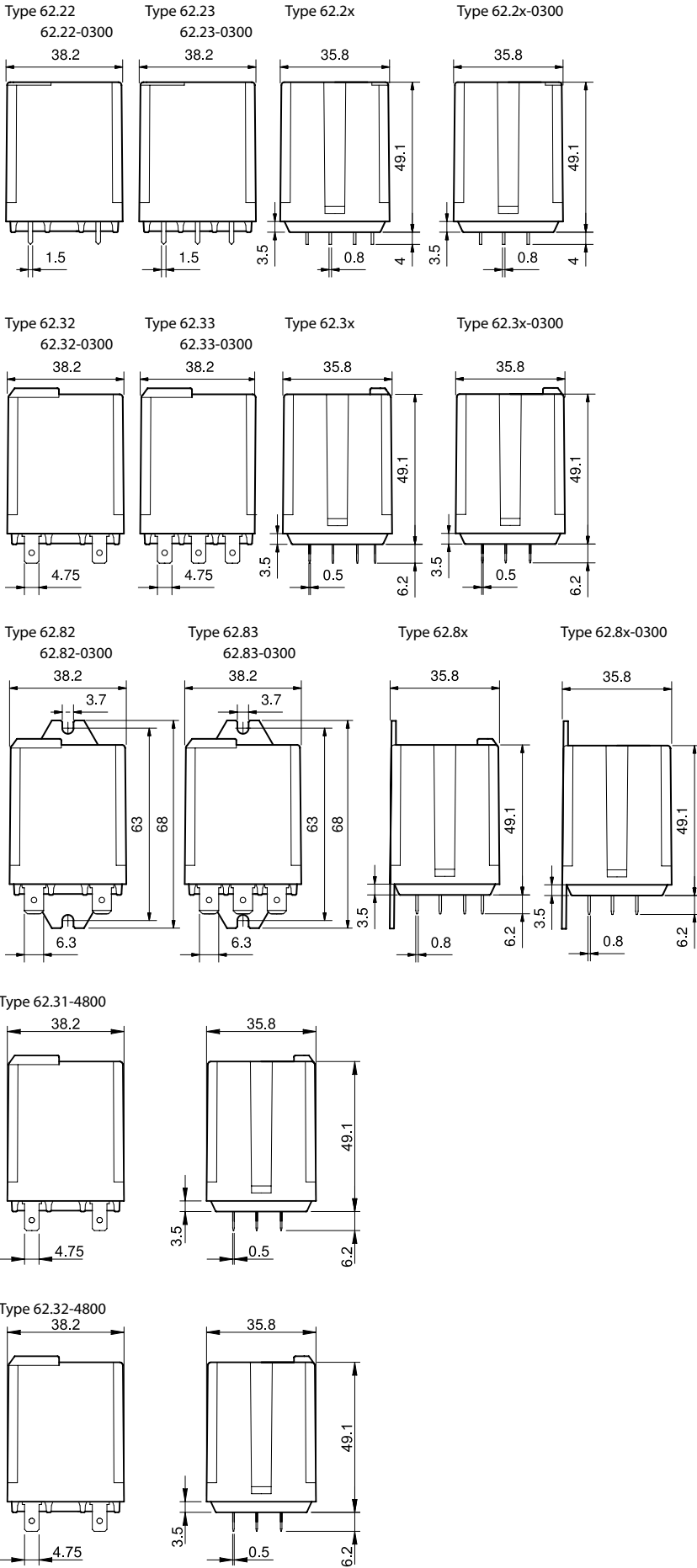

Accessories



062.10



062.10 with relay

Mounting adaptor for types 62.3x and 62.8x.xxxx.xxx9 (M4)

062.10

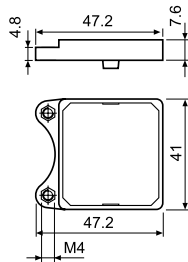

062.10

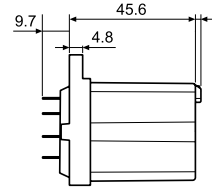
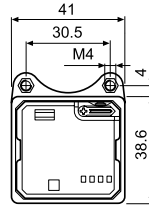

062.10 with relay

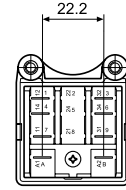

062.60



062.60 with relay

Flange mounting adaptor for types 62.3x and 62.8x.xxxx.xxx9

062.60

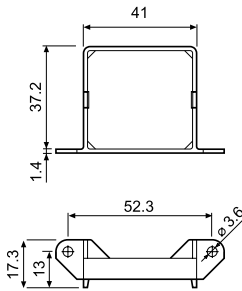

062.60

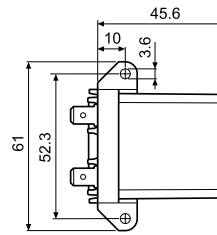

062.60 with relay

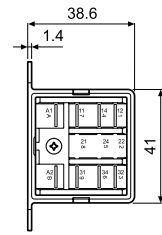

062.05



062.05 with relay

Top flange mount for types 62.3x and 62.8x.xxxx.xxx9

062.05

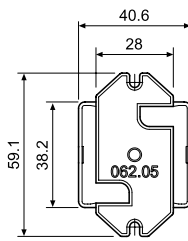

062.05

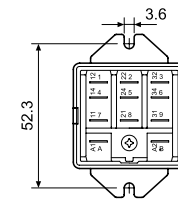
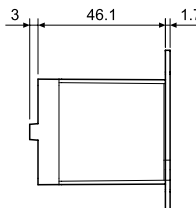

062.05 with relay

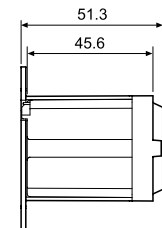

062.07



062.07 with relay

Top 35 mm rail (EN 60715) mount for types 62.3x and 62.8x.xxxx.xxx9

062.07

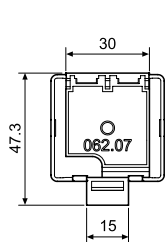

062.07

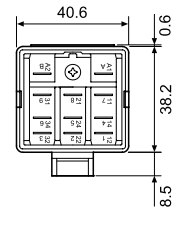
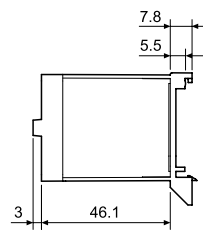

062.07 with relay

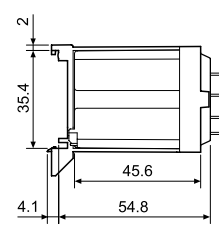

062.08



062.08 with relay

Rear 35 mm rail (EN 60715) mount for types 62.3x and 62.8x.xxxx.xxx9

062.08

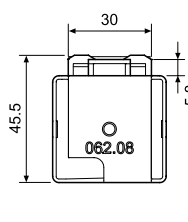

062.08

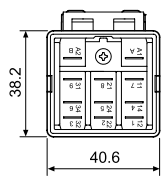
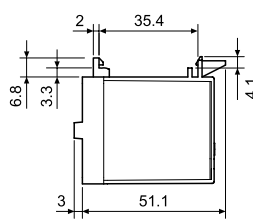

062.08 with relay

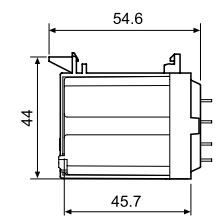

Sheet of marker tags (CEMBRE Thermal transfer printers) for 62 series relays, plastic, 48 tags, 6 x 12 mm

060.48



060.48

A



92.03

Approvals
(according to type):

Screw terminal (Box clamp) socket panel or 35 mm rail (EN 60715) mount	92.03 Blue	92.03.0 Black
For relay type	62.31, 62.32, 62.33	
Accessories		
Metal retaining clip (supplied with socket - packaging code SMA)	092.71	
Identification tag	092.00.2	
Modules (see table below)	99.02	
Timer modules (see table below)	86.00, 86.30	
Technical data		
Rated values	16 A - 250 V	
Dielectric strength	6 kV (1.2/50 μs) between coil and contacts	
Protection category	IP 20	
Ambient temperature	°C -40...+70 (see diagram L92)	
Screw torque	Nm	0.8
Wire strip length	mm 10	
Max. wire size for 92.03 socket	solid wire	stranded wire
	mm ² 1 x 10 / 2 x 4	1 x 6 / 2 x 4
	AWG 1 x 8 / 2 x 12	1 x 10 / 2 x 12

L 92 - Rated current v ambient temperature

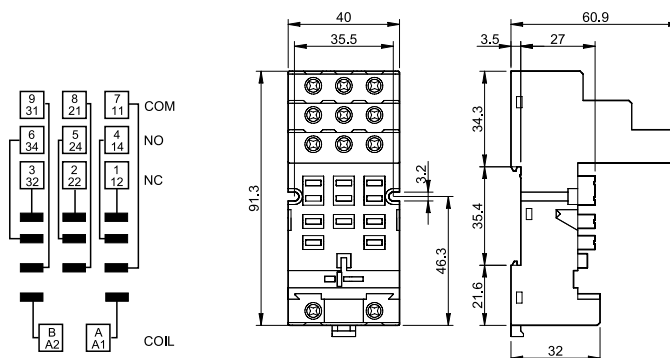
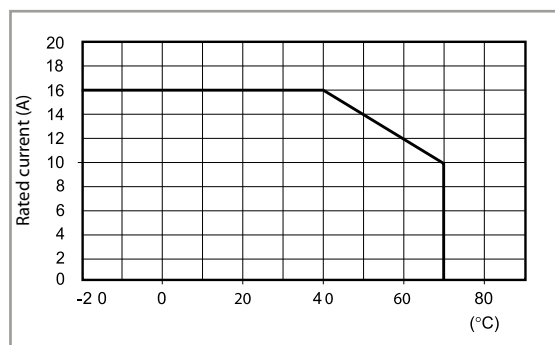

86.00



86.30



99.02

Approvals
(according to type):DC Modules with
non-standard polarity
(+A2) on request.

86 series timer modules

Multi-voltage: (12...240)V AC/DC; Multi-functions: AI, DI, SW, BE, CE, DE, EE, FE; (0.05 s...100 h)	86.00.0.240.0000
(12...24)V AC/DC; Bi-function: AI, DI; (0.05 s...100 h)	86.30.0.024.0000
(110...125)V AC; Bi-function: AI, DI; (0.05 s...100 h)	86.30.8.120.0000
(230...240)V AC; Bi-function: AI, DI; (0.05 s...100 h)	86.30.8.240.0000

Approvals
(according to type):

99.02 coil indication and EMC suppression modules for 92.03 socket

Diode (+A1, standard polarity)	(6...220)V DC	99.02.3.000.00
LED	(6...24)V DC/AC	99.02.0.024.59
LED	(28...60)V DC/AC	99.02.0.060.59
LED	(110...240)V DC/AC	99.02.0.230.59
LED + Diode (+A1, standard polarity)	(6...24)V DC	99.02.9.024.99
LED + Diode (+A1, standard polarity)	(28...60)V DC	99.02.9.060.99
LED + Diode (+A1, standard polarity)	(110...220)V DC	99.02.9.220.99
LED + Varistor	(6...24)V DC/AC	99.02.0.024.98
LED + Varistor	(28...60)V DC/AC	99.02.0.060.98
LED + Varistor	(110...240)V DC/AC	99.02.0.230.98
RC circuit	(6...24)V DC/AC	99.02.0.024.09
RC circuit	(28...60)V DC/AC	99.02.0.060.09
RC circuit	(110...240)V DC/AC	99.02.0.230.09
Residual current by-pass	(110...240)V AC	99.02.8.230.07



92.13
Approvals
(according to type):

PCB socket	92.13 (blue)	92.13.0 (black)
For relay type	62.31, 62.32, 62.33	
Accessories		
Metal retaining clip (supplied with socket - packaging code SMA)	092.54	
Technical data		
Rated values	10 A - 250 V	
Dielectric strength	2.5 kV AC	
Ambient temperature	°C -40...+70	

A

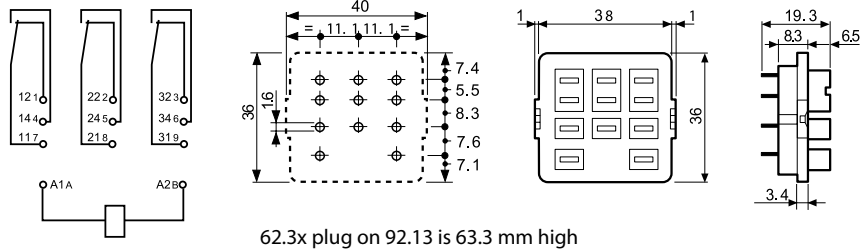

92.33
Approvals
(according to type):

Panel mount solder socket mounted with M3 screw	92.33 (blue)
For relay type	62.31, 62.32, 62.33
Accessories	
Metal retaining clip (supplied with socket - packaging code SMA)	092.54
Technical data	
Rated values	10 A - 250 V
Dielectric strength	2.5 kV AC
Ambient temperature	°C -40...+70

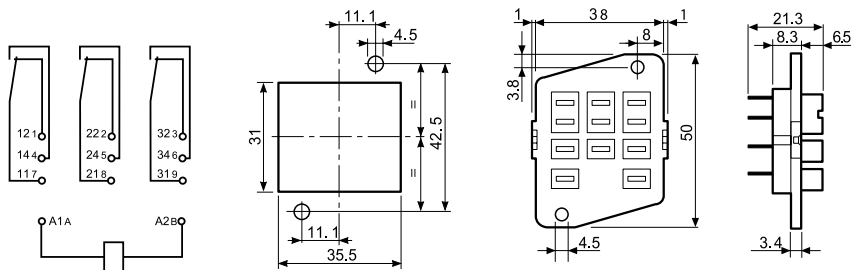

Packaging codes

How to code and identify retaining clip and packaging options for sockets.

Example:

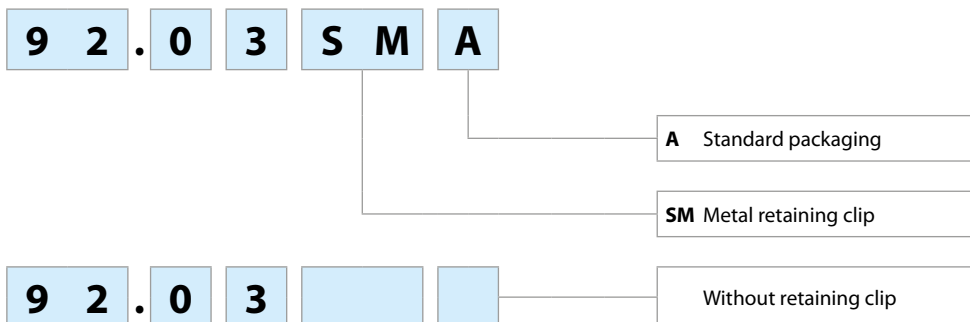



Power relays 20 - 30 A



Infrared and
microwave
ovens



Industrial washing
machines



Burners,
boilers and
furnaces



Jacuzzis and
hot tubs



Power
generators



Panels for electrical
distribution



Back-up
generators



Industrial
motors



20 A Power relays
1 NO + 1 NC (SPST-NO + SPST-NC)

Type 65.31

- Flange mount and Faston 250 connections

Type 65.61

- PCB mount

- AC coils & DC coils
- Cadmium Free option available



- 20 A rated contacts
- Faston 250 (6.3 x 0.8 mm) connection
- Flange mount

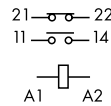

- 20 A rated contacts
- PCB mount
- Bifurcated terminals

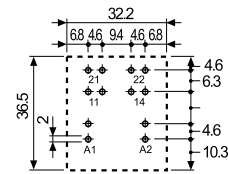
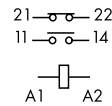

Copper side view

* With the AgSnO₂ material the maximum peak current is 120 A - 5 ms on NO contact.

FOR UL RATINGS SEE:

"General technical information" page V

For outline drawing see page 7

Contact specification

Contact configuration		1NO + 1NC (SPST-NO+SPST-NC)	1NO + 1NC (SPST-NO+SPST-NC)
Rated current/Maximum peak current	A	20/40*	20/40*
Rated voltage/Maximum switching voltage	V AC	250/400	250/400
Rated load AC1	VA	5000	5000
Rated load AC15 (230 V AC)	VA	1000	1000
Single phase motor rating (230 V AC)	kW	1.1	1.1
Breaking capacity DC1: 30/110/220 V	A	20/0.8/0.5	20/0.8/0.5
Minimum switching load	mW (V/mA)	1000 (10/10)	1000 (10/10)
Standard contact material		AgCdO	AgCdO

Coil specification

Nominal voltage (U _N)	V AC (50/60 Hz)	6 - 12 - 24 - 48 - 60 - 110 - 120 - 230 - 240 - 400
	V DC	6 - 12 - 24 - 48 - 60 - 110 - 125 - 220
Rated power AC/DC	VA (50 Hz)/W	2.2/1.3
Operating range	AC	(0.8...1.1)U _N
	DC	(0.85...1.1)U _N
Holding voltage	AC/DC	0.8 U _N / 0.6 U _N
Must drop-out voltage	AC/DC	0.2 U _N / 0.1 U _N

Technical data

Mechanical life AC/DC	cycles	10 · 10 ⁶ / 30 · 10 ⁶	10 · 10 ⁶ / 30 · 10 ⁶
Electrical life at rated load AC1	cycles	80 · 10 ³	80 · 10 ³
Operate/release time	ms	10/12	10/12
Insulation between coil and contacts (1.2/50 μs)	kV	4	4
Dielectric strength between open contacts	V AC	1500	1500
Ambient temperature range	°C	-40...+75	-40...+75
Environmental protection		RT I	RT I

Approvals (according to type)



30 A Power relays**1 NO (SPST-NO)****Type 65.31-0300**

- Flange mount and Faston 250 connections

Type 65.61-0300

- PCB mount

- ≥ 3 mm contact gap
- AC coils & DC coils
- Cadmium Free option available

65.31-0300

- 30 A rated contacts
- Faston 250 (6.3 x 0.8 mm) connection
- Flange mount

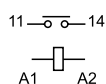
**65.61-0300**

- 30 A rated contacts
- PCB mount
- Bifurcated terminals

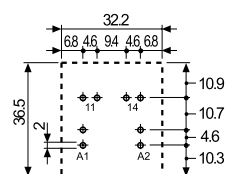
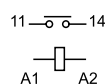

Copper side view

* Distance between contacts ≥ 3 mm (EN 60335-1).** With the AgSnO_2 material the maximum peak current is 120 A - 5 ms on NO contact.

FOR UL RATINGS SEE:

"General technical information" page V

For outline drawing see page 7

Contact specification

Contact configuration		1 NO (SPST-NO), ≥ 3 mm*	1 NO (SPST-NO), ≥ 3 mm*
Rated current/Maximum peak current	A	30/50**	30/50**
Rated voltage/Maximum switching voltage	V AC	250/400	250/400
Rated load AC1	VA	7500	7500
Rated load AC15 (230 V AC)	VA	1250	1250
Single phase motor rating (230 V AC)	kW	1.5	1.5
Breaking capacity DC1: 30/110/220 V	A	30/1.1/0.7	30/1.1/0.7
Minimum switching load	mW (V/mA)	1000 (10/10)	1000 (10/10)
Standard contact material		AgCdO	AgCdO

Coil specification

Nominal voltage (U_N)	V AC (50/60 Hz)	6 - 12 - 24 - 48 - 60 - 110 - 120 - 230 - 240 - 400
	V DC	6 - 12 - 24 - 48 - 60 - 110 - 125 - 220
Rated power AC/DC	VA (50 Hz)/W	2.2/1.3
Operating range	AC	(0.8...1.1) U_N
	DC	(0.85...1.1) U_N
Holding voltage	AC/DC	0.8 U_N / 0.6 U_N
Must drop-out voltage	AC/DC	0.2 U_N / 0.1 U_N

Technical data

Mechanical life AC/DC	cycles	$10 \cdot 10^6 / 30 \cdot 10^6$	$10 \cdot 10^6 / 30 \cdot 10^6$
Electrical life at rated load AC1	cycles	$50 \cdot 10^3$	$50 \cdot 10^3$
Operate/release time	ms	15/4	15/4
Insulation between coil and contacts (1.2/50 μs)	kV	4	4
Dielectric strength between open contacts	V AC	2500	2500
Ambient temperature range	$^{\circ}\text{C}$	-40...+75	-40...+75
Environmental protection		RT I	RT I

Approvals (according to type)

Ordering information

Example: 65 series power relay, PCB with bifurcated terminals, 1 NO + 1 NC (SPST-NO + SPST-NC) contact, 12 V DC coil.

	6	5	.	6		1	.	9	.	0	1	2	.	0	0		0	0	
Series	65.6					1.9			012					A	B		C	D	
Type	3 = Faston 250 (6.3 x 0.8 mm) with rear flange mount 6 = PCB with bifurcated terminals													A: Contact material 0 = Standard AgCdO 4 = AgSnO ₂			D: Special versions 0 = Standard 9 = Type 65.31 without rear flange mount		
No. of poles	1 = 1 NO + 1 NC (SPST-NO + SPST-NC)													B: Contact circuit 0 = 1 NO + 1 NC (SPST-NO + SPST-NC) 3 = NO (≥ 3 mm contact gap)			C: Options 0 = None		
Coil version	8 = AC (50/60 Hz) 9 = DC																		
Coil voltage	See coil specifications																		

Selecting features and options: only combinations in the same row are possible.
Preferred selections for best availability are shown in **bold**.

Type	Coil version	A	B	C	D
65.31	AC-DC	0 - 4	0 - 3	0	0 - 9
65.61	AC-DC	0 - 4	0 - 3	0	0

Technical data

Insulation according to EN 61810-1					
		1 NO + 1 NC		1 NO	
Nominal voltage supply system	V AC	230/400		230/400	
Rated insulation voltage	V AC	250	400	250	400
Pollution degree		3	2	3	2
Insulation between coil and contact set					
Type of insulation		Basic		Basic	
Overtoltage category		III		III	
Rated impulse voltage	kV (1.2/50 μs)	4		4	
Dielectric strength	V AC	2500		2500	
Insulation between open contacts					
Type of disconnection		Micro-disconnection		Full-disconnection	
Overtoltage category		—		III	
Rated impulse voltage	kV (1.2/50 μs)	—		4	
Dielectric strength	V AC/kV (1.2/50 μs)	1500/2		2500/4	
Insulation between coil terminals					
Rated impulse voltage (surge) differential mode (according to EN 61000-4-5)	kV (1.2/50 μs)	4			
Other data					
Bounce time: NO/NC	ms	5/6 (1 NO + 1 NC)		7/— (1 NO)	
Vibration resistance (10...150)Hz: NO/NC	g	20/13			
Shock resistance	g	20			
Power lost to the environment	without contact current	W	1.3		
	with rated current	W	2.1 (65.31, 65.61)		3.1 (65.31/61.0300)
Recommended distance between relays mounted on PCB	mm	≥ 5			

Contact specification

F 65 - Electrical life (AC) v contact current

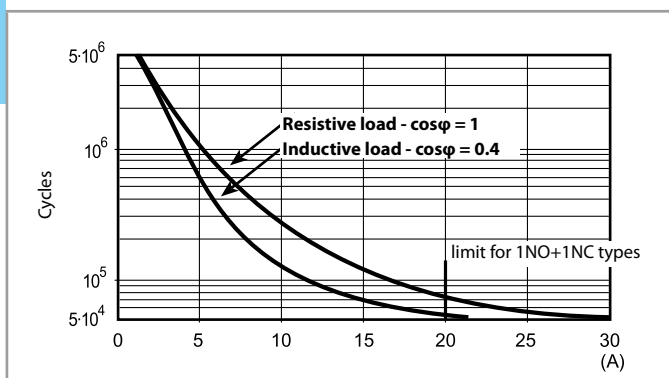

H 65 - Maximum DC1 breaking capacity

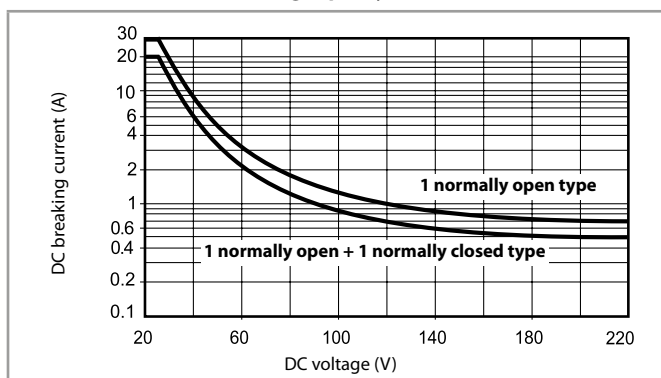

- When switching a resistive load (DC1) having voltage and current values under the curve, an electrical life of $\geq 80 \cdot 10^3$ can be expected.
- In the case of DC13 loads, the connection of a diode in parallel with the load will permit a similar electrical life as for a DC1 load.
Note: the release time for the load will be increased.

Coil specifications

DC coil data

Nominal voltage U_N V	Coil code	Operating range		Resistance R Ω	Rated coil consumption I at U_N mA
		U_{min} V	U_{max} V		
6	9.006	5.1	6.6	28	214
12	9.012	10.2	13.2	110	109
24	9.024	20.4	26.4	445	54
48	9.048	40.8	52.8	1770	27.1
60	9.060	51	66	2760	21.7
110	9.110	93.5	121	9420	11.7
125	9.125	106	138	12000	10.4
220	9.220	187	242	37300	5.8

AC coil data

Nominal voltage U_N V	Coil code	Operating range		Resistance R Ω	Rated coil consumption I at U_N (50 Hz) mA
		U_{min} V	U_{max} V		
6	8.006	4.8	6.6	4.6	367
12	8.012	9.6	13.2	19	183
24	8.024	19.2	26.4	74	90
48	8.048	38.4	52.8	290	47
60	8.060	48	66	450	37
110	8.110	88	121	1600	20
120	8.120	96	132	1940	18.6
230	8.230	184	253	7250	10.5
240	8.240	192	264	8500	9.2
400	8.400	320	440	19800	6

R 65 - DC coil operating range v ambient temperature

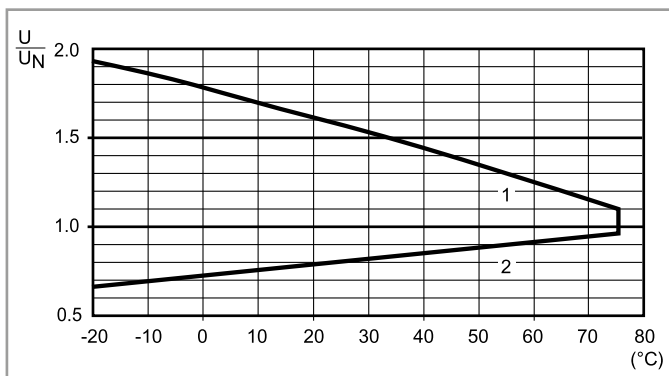

- 1 - Max. permitted coil voltage.
- 2 - Min. pick-up voltage with coil at ambient temperature.

R 65 - AC coil operating range v ambient temperature

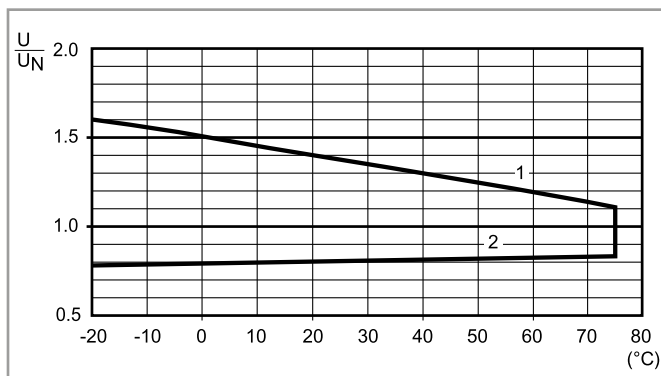

- 1 - Max. permitted coil voltage.
- 2 - Min. pick-up voltage with coil at ambient temperature.

Outline drawings

Type 65.31

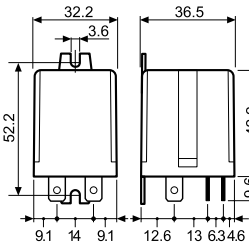

Type 65.61

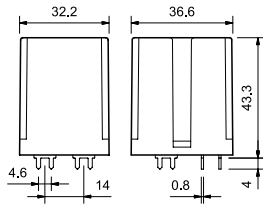

Type 65.31-0300

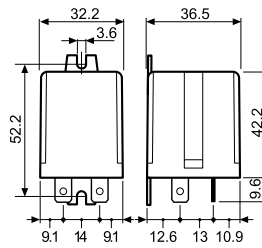

Type 65.61-0300

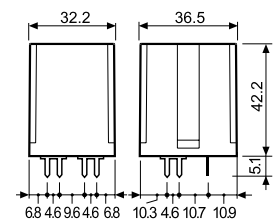

Accessories



065.05



065.05 with relay

Top flange mount for types 65.31.xxxx.xxx9

065.05

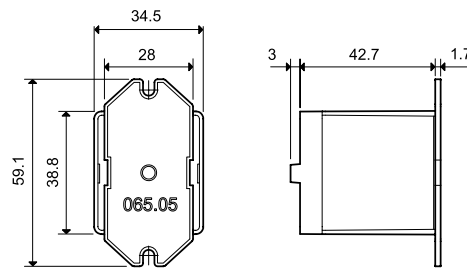

065.05

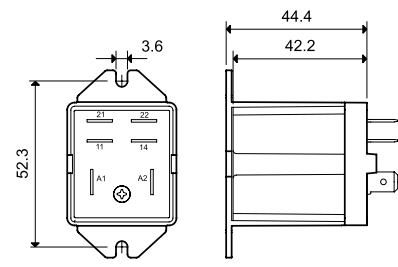

065.05 with relay



065.07



065.07 with relay

Top 35 mm rail (EN 60715) mount for types 65.31.xxxx.xxx9

065.07

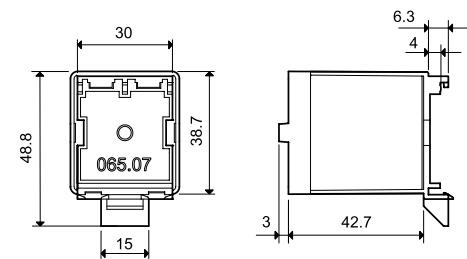

065.07

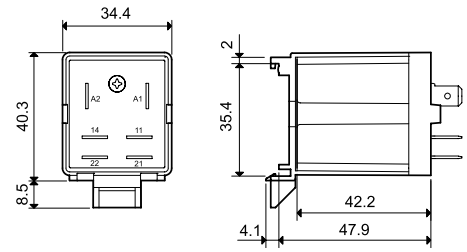

065.07 with relay



065.08



065.08 with relay

Rear 35 mm rail (EN 60715) mount for types 65.31.xxxx.xxx9

065.08

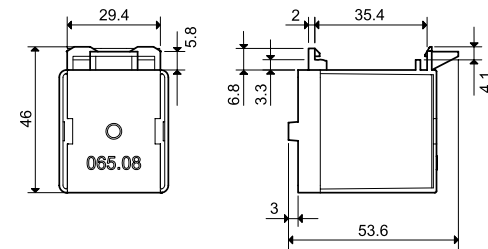

065.08

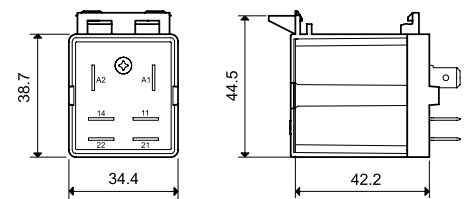

065.08 with relay



finder®

SWITCH TO THE FUTURE

66
SERIES

Relè di potenza 30 A



Power generators



Industrial washing machines



Burners, boilers and furnaces



Industrial furnaces and ovens



Air conditioners



Hoists and cranes



Back-up generators



Industrial motors



**2 Pole Changeover (DPDT)
30 A Power relay**

Type 66.22

- PCB connections & mount

Type 66.82

- Faston 250 connections and Flange mount

- Reinforced insulation between coil and contacts according to EN 60335-1; 8 mm creepage and clearance distances
- AC coils & DC coils
- Cadmium Free option available
- ATEX compliant (EX nC) option available

66.22



- 30 A rated contacts
- PCB mount - bifurcated terminals

66.82



- 30 A rated contacts
- Flange mount
- Faston 250 connections

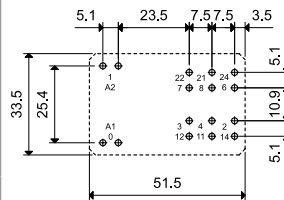
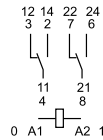

Copper side view

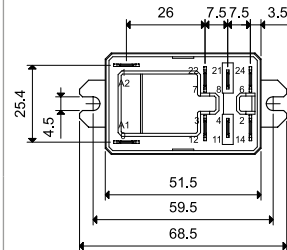
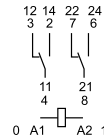

For outline drawing see page 9

FOR UL RATINGS SEE:

"General technical information" page V

Contact specification

Contact configuration		2 CO (DPDT)	2 CO (DPDT)
Rated current/Maximum peak current	A	30/50 (NO) - 10/20 (NC)	30/50 (NO) - 10/20 (NC)
Rated voltage/ Maximum switching voltage	V AC	250/440	250/440
Rated load AC1	VA	7500 (NO) - 2500 (NC)	7500 (NO) - 2500 (NC)
Rated load AC15 (230 V AC)	VA	1200 (NO)	1200 (NO)
Single phase motor rating (230 V AC)	kW	1.5 (NO)	1.5 (NO)
Breaking capacity DC1: 30/110/220 V	A	25/0.7/0.3 (NO)	25/0.7/0.3 (NO)
Minimum switching load	mW (V/mA)	1000 (10/10)	1000 (10/10)
Standard contact material		AgCdO	AgCdO

Coil specification

Nominal voltage (U _N)	V AC (50/60 Hz)	6 - 12 - 24 - 110/115 - 120/125 - 230 - 240	
	V DC	6 - 12 - 24 - 110 - 125	
Rated power AC/DC	VA (50 Hz)/W	3.6/1.7	3.6/1.7
Operating range	AC	(0.8...1.1)U _N	(0.8...1.1)U _N
	DC	(0.8...1.1)U _N	(0.8...1.1)U _N
Holding voltage	AC/DC	0.8 U _N / 0.5 U _N	0.8 U _N / 0.5 U _N
Must drop-out voltage	AC/DC	0.2 U _N / 0.1 U _N	0.2 U _N / 0.1 U _N

Technical data

Mechanical life AC/DC	cycles	10 · 10 ⁶	10 · 10 ⁶
Electrical life at rated load AC1	cycles	100 · 10 ³	100 · 10 ³
Operate/release time	ms	8/15	8/15
Insulation between coil and contacts (1.2/50 μs)	kV	6 (8 mm)	6 (8 mm)
Dielectric strength between open contacts	V AC	1500	1500
Ambient temperature range	°C	-40...+70	-40...+70
Environmental protection		RT II	RT II

Approvals (according to type)



2 Pole NO (DPST-NO)**30 A Power relay****Type 66.22-x300**

- PCB mount

Type 66.82-x300

- Faston 250 connections and Flange mount

- Reinforced insulation between coil and contacts according to EN 60335-1; 8 mm creepage and clearance distances
- AC coils & DC coils
- Cadmium Free option available
- ATEX compliant (EX nC) option available

A

66.22-x30x

- 30 A rated contacts
- PCB mount - bifurcated terminals

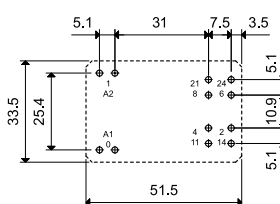
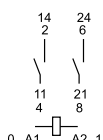

Copper side view

66.82-x30x

- 30 A rated contacts
- Flange mount
- Faston 250 connections

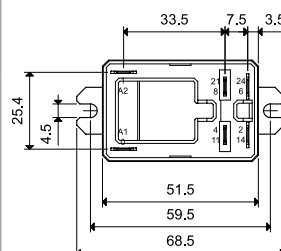
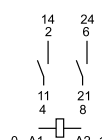

For outline drawing see page 9

FOR UL RATINGS SEE:

"General technical information" page V

Contact specification

Contact configuration		2 NO (DPST-NO)	2 NO (DPST-NO)
Rated current/Maximum peak current	A	30/50	30/50
Rated voltage/ Maximum switching voltage	V AC	250/440	250/440
Rated load AC1	VA	7500	7500
Rated load AC15 (230 V AC)	VA	1200	1200
Single phase motor rating (230 V AC)	kW	1.5	1.5
Breaking capacity DC1: 30/110/220 V	A	25/0.7/0.3	25/0.7/0.3
Minimum switching load	mW (V/mA)	1000 (10/10)	1000 (10/10)
Standard contact material		AgCdO	AgCdO

Coil specification

Nominal voltage (U_N)	V AC (50/60 Hz)	6 - 12 - 24 - 110/115 - 120/125 - 230 - 240	
	V DC	6 - 12 - 24 - 110 - 125	
Rated power AC/DC	VA (50 Hz)/W	3.6/1.7	3.6/1.7
Operating range	AC	$(0.8 \dots 1.1) U_N$	$(0.8 \dots 1.1) U_N$
	DC	$(0.8 \dots 1.1) U_N$	$(0.8 \dots 1.1) U_N$
Holding voltage	AC/DC	$0.8 U_N / 0.5 U_N$	$0.8 U_N / 0.5 U_N$
Must drop-out voltage	AC/DC	$0.2 U_N / 0.1 U_N$	$0.2 U_N / 0.1 U_N$

Technical data

Mechanical life AC/DC	cycles	$10 \cdot 10^6$	$10 \cdot 10^6$
Electrical life at rated load AC1	cycles	$100 \cdot 10^3$	$100 \cdot 10^3$
Operate/release time	ms	8/10	8/10
Insulation between coil and contacts (1.2/50 μ s)	kV	6 (8 mm)	6 (8 mm)
Dielectric strength between open contacts	V AC	1500	1500
Ambient temperature range	$^{\circ}$ C	-40...+70	-40...+70
Environmental protection		RT II	RT II

Approvals (according to type)



**2 Pole NO (DPST-NO), ≥ 1.5 mm contact gap
30 A Power relay**

Type 66.22-x600

- PCB mount

Type 66.22-x600S

- PCB mount, 5 mm gap between PCB and relay base

Type 66.82-x600

- Faston 250 connections and Flange mount

- ≥ 1.5 mm contact gap (according to VDE 0126-1-1 for solar inverter applications)
- Reinforced insulation between coil and contacts according to EN 60335-1; 8 mm creepage and clearance distances
- Wash tight version (RT III) available
- DC coils
- Cadmium Free option available
- ATEX compliant (EX nC) option available

For outline drawing see page 9

FOR UL RATINGS SEE:

"General technical information" page V

66.22-x60x



- PCB mount - bifurcated terminals

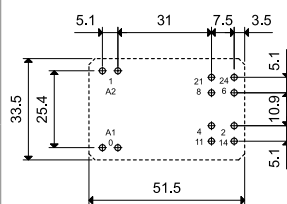
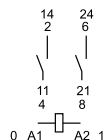

Copper side view

66.22-x60xS



- PCB mount - bifurcated terminals
- 5 mm gap between PCB and relay base

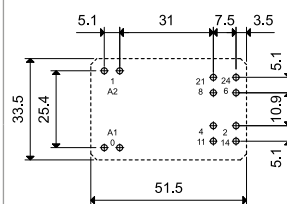
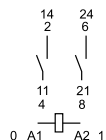

Copper side view

66.82-x60x



- Flange mount
- Faston 250 connections

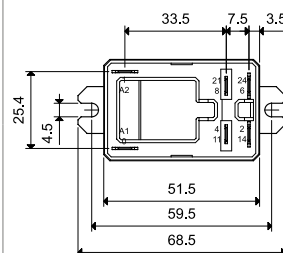
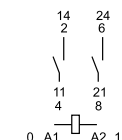

Contact specification				
Contact configuration		2 NO (DPST-NO)	2 NO (DPST-NO)	2 NO (DPST-NO)
Rated current/Maximum peak current	A	30/50	30/50	30/50
Rated voltage/				
Maximum switching voltage	V AC	250/440	250/440	250/440
Rated load AC1	VA	7500	7500	7500
Rated load AC15 (230 V AC)	VA	1200	1200	1200
Single phase motor rating (230 V AC)	kW	1.5	1.5	1.5
Breaking capacity DC1: 30/110/220 V	A	25/1.2/0.5	25/1.2/0.5	25/1.2/0.5
Minimum switching load	mW (V/mA)	1000 (10/10)	1000 (10/10)	1000 (10/10)
Standard contact material		AgCdO	AgCdO	AgCdO
Coil specification				
Nominal voltage (U_N)	V AC (50/60 Hz)	—		
	V DC	6 - 12 - 24 - 110 - 125		
Rated power AC/DC	VA (50 Hz)/W	—/1.7	—/1.7	—/1.7
Operating range	AC	—		
	DC	$(0.8 \dots 1.1) U_N$		
Holding voltage	AC/DC	$—/0.5 U_N$		
Must drop-out voltage	AC/DC	$—/0.1 U_N$		
Technical data				
Mechanical life	cycles	$10 \cdot 10^6$		
Electrical life at rated load AC1	cycles	$100 \cdot 10^3$		
Operate/release time	ms	15/4		
Insulation between coil and contacts (1.2/50 μ s)	kV	6 (8 mm)		
Dielectric strength between open contacts	V AC	2500		
Ambient temperature range	$^{\circ}$ C	-40...+70		
Environmental protection		RT II		
Approvals (according to type)				

Ordering information

Example: 66 series relay, Faston 250 (6.3x0.8 mm) with top flange mount, 2 CO (DPDT) 30 A contacts, 24 V DC coil.

A

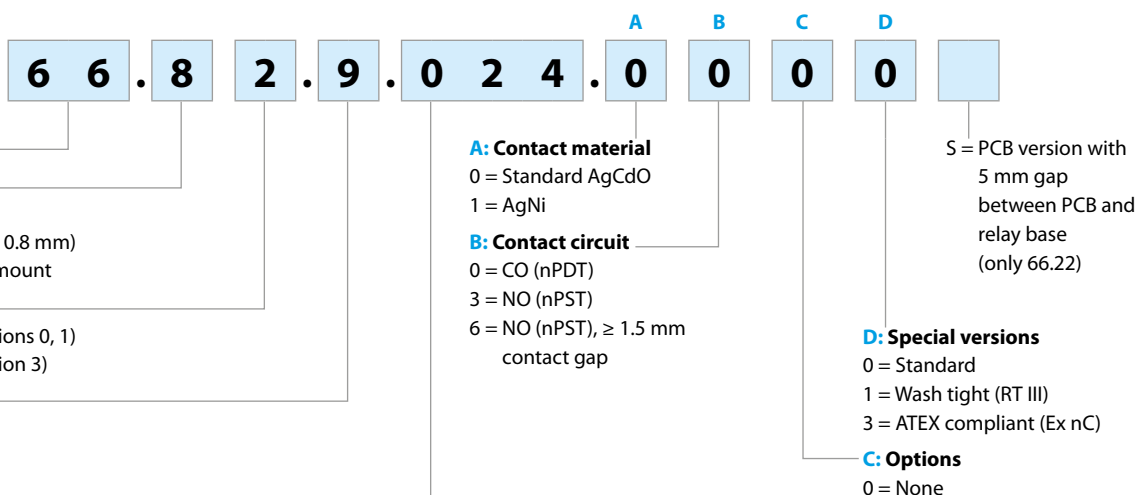

Selecting features and options: only combinations in the same row are possible.

Preferred selections for best availability are shown in **bold**.

Type	Coil version	A	B	C	D
66.22	AC-DC	0 - 1	0 - 3	0	0 - 1
	DC	0 - 1	6	0	0 - 1
66.22...S	DC	0 - 1	6	0	0 - 1 - 3
66.82	AC-DC	0 - 1	0 - 3	0	0 - 1 - 3
	DC	0 - 1	6	0	0 - 1 - 3

Technical data

Insulation according to EN 61810-1

Nominal voltage of supply system	V AC	230/400
Rated insulation voltage	V AC	400
Pollution degree		3
Insulation between coil and contact set		
Type of insulation		Reinforced (8 mm)
Overvoltage category		III
Rated impulse voltage	kV (1.2/50 µs)	6
Dielectric strength	V AC	4000
Insulation between adjacent contacts		
Type of insulation		Basic
Overvoltage category		III
Rated impulse voltage	kV (1.2/50 µs)	4
Dielectric strength	V AC	2500
Insulation between open contacts		
Type of disconnection		2 CO Micro-disconnection
Overvoltage category		2 NO, ≥ 1.5 mm (x60x version) Full-disconnection*
Rated impulse voltage	kV (1.2/50 µs)	—
Dielectric strength	V AC/kV (1.2/50 µs)	1500/2
Insulation between coil terminals		
Rated impulse voltage (surge) differential mode (according to EN 61000-4-5)	kV(1.2/50 µs)	4
Other data		
Bounce time: NO/NC	ms	7/10
Vibration resistance (10...150)Hz: NO/NC	g	20/19
Shock resistance	g	20
Power lost to the environment	without contact current	W
	with rated current	W
Recommended distance between relays mounted on PCB	mm	≥ 10

* Only in applications where over voltage category II is permitted. In applications of over voltage category III: Micro-disconnection.

Contact specification

F 66 - Electrical life (AC) v contact current
250 V (normally open contact)

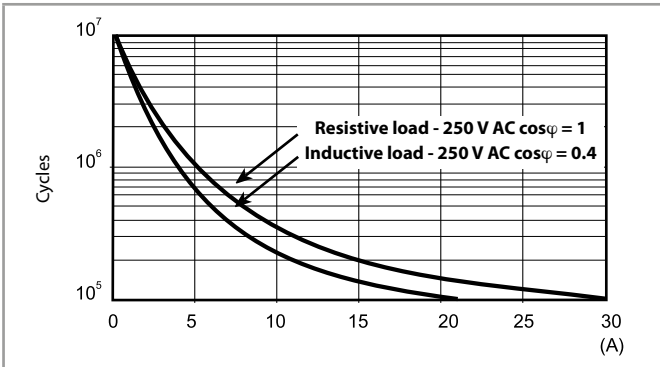

F 66 - Electrical life (AC) v contact current
440 V (normally open contact)

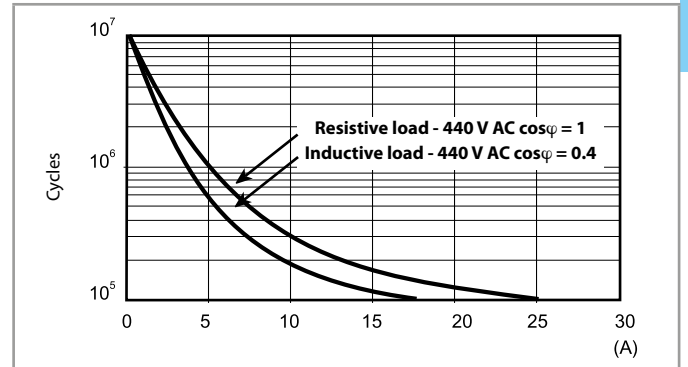

H 66 - Maximum DC breaking capacity

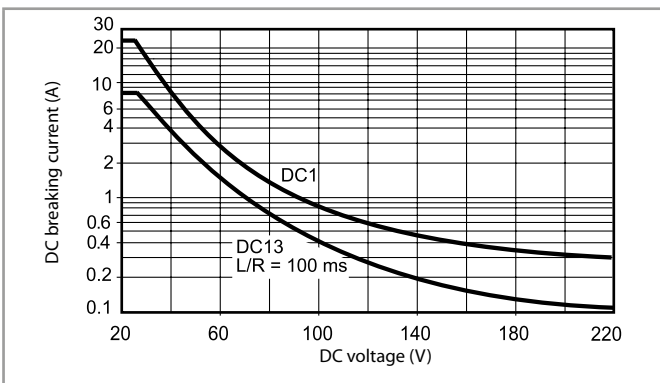

H 66 - Maximum DC breaking capacity, x60x versions
(> 1.5 mm contact gap)

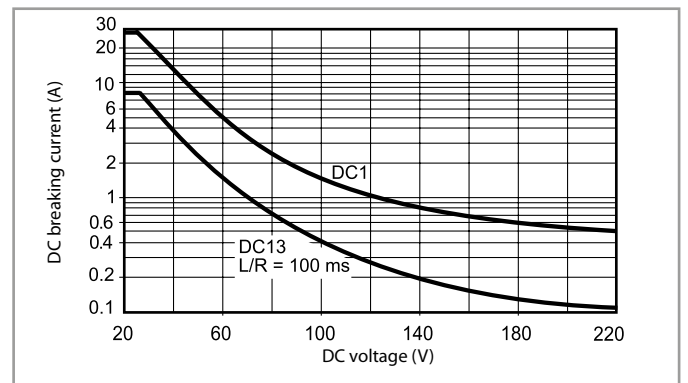

- When switching a resistive load (DC1) having voltage and current values under the curve, an electrical life of $\geq 100 \cdot 10^3$ can be expected.
- In the case of DC13 loads, the connection of a diode in parallel with the load will permit a similar electrical life as for a DC1 load.
Note: the release time for the load will be increased.

Coil specifications

DC coil data

Nominal voltage	Coil code	Operating range		Resistance	Rated coil Consumption
		U_{min}	U_{max}		
U_N		V	V	R	I at U_N
V		V	V	Ω	mA
6	9.006	4.8	6.6	21	283
12	9.012	9.6	13.2	85	141
24	9.024	19.2	26.4	340	70.5
110	9.110	88	121	7000	15.7
125	9.125	100	138	9200	13.6

AC coil data

Nominal voltage	Coil code	Operating range		Resistance	Rated coil Consumption
		U_{min}	U_{max}		
U_N		V	V	R	I at U_N (50 Hz)
V		V	V	Ω	mA
6	8.006	4.8	6.6	3	600
12	8.012	9.6	13.2	11	300
24	8.024	19.2	26.4	50	150
110/115	8.110	88	126	930	32.6
120/125	8.120	96	137	1050	30
230	8.230	184	253	4000	15.7
240	8.240	192	264	5500	15

R 66 - DC coil operating range v ambient temperature

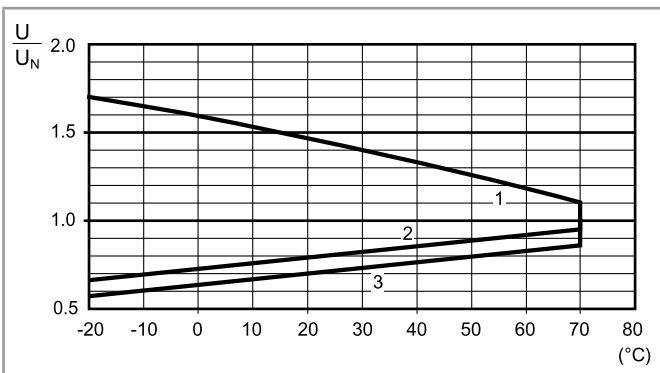

R 66 - AC coil operating range v ambient temperature

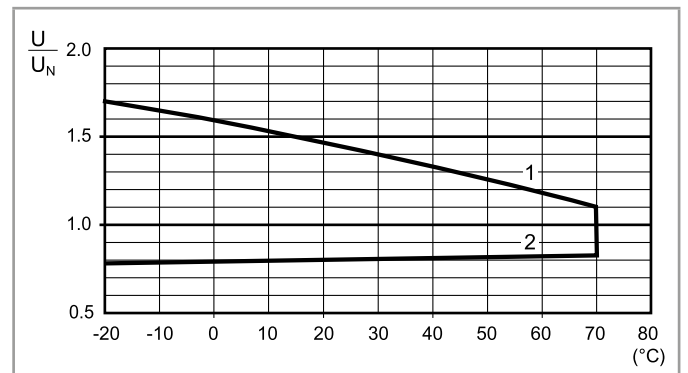

- 1 - Max. permitted coil voltage.
2 - Min. pick-up voltage with coil at ambient temperature.
3 - Min. pick-up voltage with coil at ambient temperature (66.22-x60x5)

- 1 - Max. permitted coil voltage.
2 - Min. pick-up voltage with coil at ambient temperature.

Features compliant variant ATEX, II 3G Ex nC IIC Gc

A

MARKING	
	Specific marking of explosion protection
II	Component for surface plant (different from mines)
3	Category 3: normal level of protection
GAS	G Explosive atmosphere due to presence of combustible gas vapour or mist
	Ex nC Sealed device (type of protection for category 3G)
	IIC Gas group
	Gc Equipment Protection Level
-40 °C ≤ Ta ≤ +70 °C Ambient temperature	
EUT 14 ATEX 0150 U EUT: laboratory which issues the CE type certificate 14: year of issue of certificate 0150: number of CE type certificate U: ATEX component	



Electrical characteristics

Characteristics of terminals

Rated current/Maximum peak current	A	25/50 (NO) - 10/20 (NC)
Rated voltage/Maximum switching voltage	V AC	250/400
Rated load AC1	VA	6250 (NO) - 2500 (NC)
Rated load AC15	VA	1200 (NO)
Capacity for single phase motor (230 V AC)	kW	1.5 (NO)
Breaking capacity DC1: 30/110/220 V	A	25/0.7/0.3 (NO)

Characteristics of coil

Rated voltage (U _N)	V AC (50/60 Hz)	6 - 12 - 24 - 110/115 - 120/125 - 230 - 240
	V DC	6 - 12 - 24 - 110 - 125
Rated Power AC/DC	VA (50 Hz)/W	3.6/1.7
Operating range	AC/DC	(0.8...1.1)U _N

General characteristics

Ambient temperature	°C	-40...+70
---------------------	----	-----------

Special condition for safe use

The component must be placed inside an enclosure that meets the general requirements for enclosures as per clause 6.3 of EN 60079-15. The connections must be made in compliance with the requirements of clause 7.2.4 or 7.2.5 of EN 60079-15.

Wiring

The cross-section of conductors connected to the terminals, must be at least 4 mm² for the Type 66.82.

Layout pcb

The minimum cross-section of the tracks of the printed circuit board must be 0.58 mm², while the width must be at least 4 mm for Types "66.22" and "66.22...S".

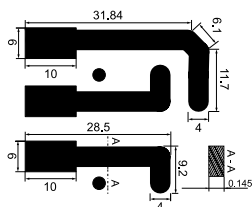

A

Outline drawings

Type 66.22

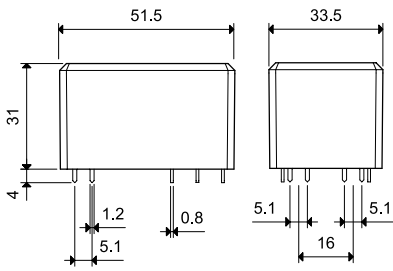

Type 66.82

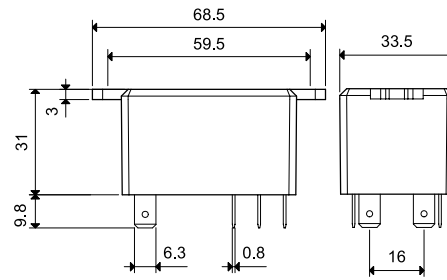

Type 66.22-0300

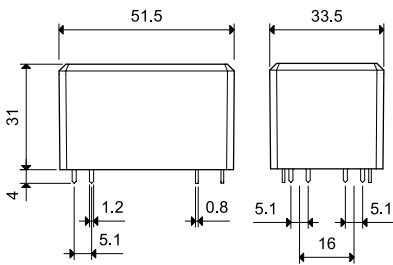

Type 66.82-0300

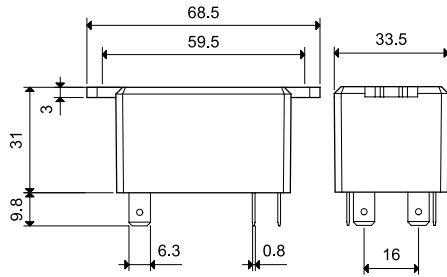

Type 66.22-0600

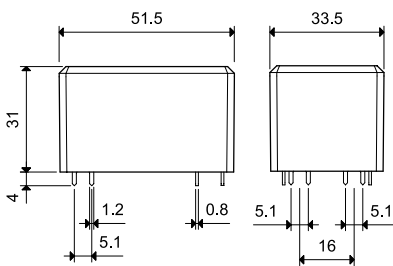

Type 66.82-0600

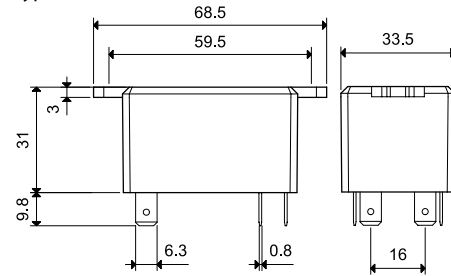

Type 66.22-0600S

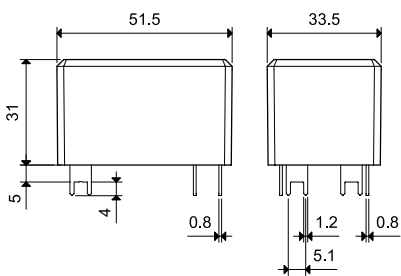

Accessories



066.07



066.07 with relay

Top 35 mm rail (EN 60715) mount for types 66.82.xxxx.0x00

066.07

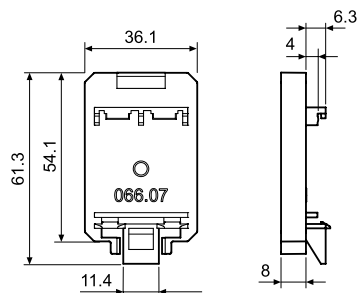

066.07

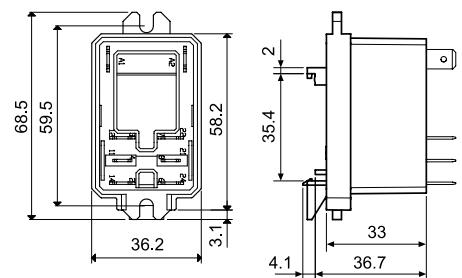

066.07 with relay

High Power relay 50 A



Power generators



Back-up generators



Pump control



Disabled lift



Inverter



Printed circuit mount - 3 mm contact gap
50 A Power relay for photovoltaic inverters

Type 67.22-x300
- 2 NO

Type 67.23-x300
- 3 NO

- Contact gap ≥ 3 mm (according to VDE 0126-1-1, EN 62109-1, EN 62109-2)
- DC coils, with only 170 mW holding power
- Reinforced insulation between coil and contacts
- 1.5 mm gap between PCB and relay base
- Suitable for use at ambient temperatures up to 85 °C (with energy-saving coil energization) or 70 °C (with standard coil energization)
- Meets the EN 60335-1 requirements of resistance to heat and fire (GWIT 775 °C and GWFI 850 °C)
- Cadmium free contact materials:
 - AgNi version (for applications where lower contact resistance is needed)
 - AgSnO₂ version (for applications where higher inrush current values are expected)

For outline drawing see page 8

Contact specification

Contact configuration

Contact gap mm

Rated current/ Maximum peak current (for 5 ms) A

Rated voltage/ Maximum switching voltage V AC

Rated load AC1/AC7a (per pole) VA

Rated load AC15 (per pole @ 230 V AC) VA

Single-phase motor rating (230 V AC) kW

Three-phase motor rating (480 V AC) kW

Breaking capacity DC1: 24/110/220 V A

Minimum switching load mW (V/mA)

Standard contact material

Coil specification

Nominal voltage (U_N) V DC

Rated power W

Operating range (-40...+70)°C DC

Energy-saving mode (-40...+85)°C

Operating range for 1 s

Holding voltage range DC

Minimum holding power W

Must drop-out voltage DC

Technical data

Mechanical life cycles

Electrical life at rated load AC7a cycles

Operate/release time ms

Ambient temperature range (energy-saving mode) °C

Environmental protection

Approvals (according to type)

67.22-x300



- 2 NO
- Contact gap ≥ 3 mm
- PCB mount

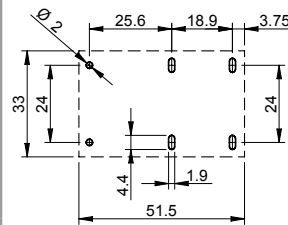
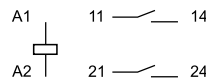

Copper side view

67.23-x300



- 3 NO
- Contact gap ≥ 3 mm
- PCB mount

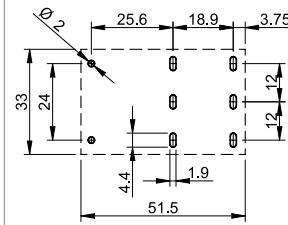
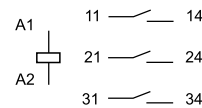

Copper side view

2 NO (DPST-NO)

3 NO (3PST-NO)

≥ 3

≥ 3

50/150

50/150

400/690

400/690

20000

20000

2300

2300

2.2

2.2

—

11

50/4/1

50/4/1

1000 (10/10)

1000 (10/10)

AgSnO₂

AgSnO₂

5 - 6 - 8 - 12 - 24 - 48 - 60 - 110

1.7

1.7

(0.90 ... 1.1)U_N

(0.90 ... 1.1)U_N

(0.95...2.5)U_N

(0.95...2.5)U_N

(0.32...0.65)U_N

(0.32...0.65)U_N

0.17

0.17

0.05 U_N

0.05 U_N

1 · 10⁶

1 · 10⁶

30 · 10³

30 · 10³

25/5

25/5

-40...+70 (-40...+85)

-40...+70 (-40...+85)

RT II

RT II



**Printed circuit mount - 5.2 mm contact gap
50 A Power relay for photovoltaic inverters**
Type 67.22-x500

- 2 NO

Type 67.23-x500

- 3 NO

- Contact gap ≥ 5.2 mm (according to VDE 0126-1-1, EN 62109-1, EN 62109-2)
- Suitable for inverters with DC input up to 1500 V and AC output up to 690 V, installations up to 4000 m above sea level
- DC coils, with only 170 mW holding power
- Reinforced insulation between coil and contacts
- 1.5 mm gap between PCB and relay base
- Suitable for use at ambient temperatures up to 85 °C (with energy-saving coil energization) or 60 °C (with standard coil energization)
- Meets the EN 60335-1 requirements of resistance to heat and fire (GWIT 775 °C and GWFI 850 °C)
- Cadmium free contact materials:
 - AgNi version (for applications where lower contact resistance is needed)
 - AgSnO₂ version (for applications where higher inrush current values are expected)

For outline drawing see page 8

Contact specification

Contact configuration

67.22-x500

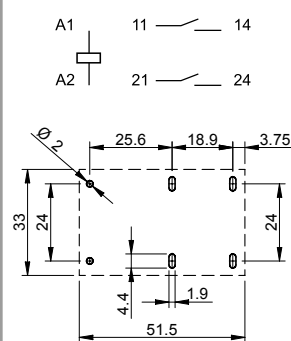

- 2 NO
- Contact gap ≥ 5.2 mm
- PCB mount



Copper side view

67.23-x500

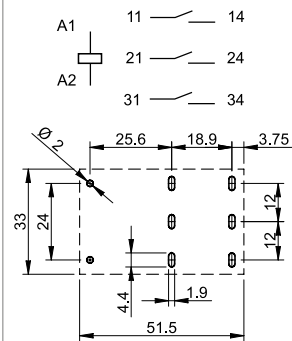
- 3 NO
- Contact gap ≥ 5.2 mm
- PCB mount



Copper side view

Contact gap

mm

 ≥ 5.2
 ≥ 5.2

 Rated current/
Maximum peak current (for 5 ms)

A

50/150

50/150

 Rated voltage/
Maximum switching voltage

V AC

400/690

400/690

Rated load AC1/AC7a (per pole)

VA

20000

20000

Rated load AC15 (per pole @ 230 V AC)

VA

2300

2300

Single-phase motor rating (230 V AC)

kW

2.2

2.2

Three-phase motor rating (480 V AC)

kW

—

11

Breaking capacity DC1: 24/110/220

A

50/7/2

50/7/2

Minimum switching load

mW (V/mA)

1000 (10/10)

1000 (10/10)

Standard contact material

 AgSnO₂

 AgSnO₂
Coil specification

 Nominal voltage (U_N)

V DC

5 - 6 - 8 - 12 - 24 - 48 - 60 - 110

Rated power

W

2.7

2.7

Operating range (-40...+60)°C

DC

 (0.90 ... 1.1)U_N

 (0.90 ... 1.1)U_N

Energy-saving mode (-40...+85)°C

Operating range for 1 s

 (0.95...2.5)U_N

 (0.95...2.5)U_N

Holding voltage range

DC

 (0.25...0.5)U_N

 (0.25...0.5)U_N

Minimum holding power

W

0.17

0.17

Must drop-out voltage

DC

 0.05 U_N

 0.05 U_N
Technical data

Mechanical life

cycles

 1 · 10⁶

 1 · 10⁶

Electrical life at rated load AC7a

cycles

 30 · 10³

 30 · 10³

Operate/release time

ms

30/4

30/4

 Ambient temperature range
(energy-saving mode)

°C

-40...+60 (-40...+85)

-40...+60 (-40...+85)

Environmental protection

RT II

RT II

Approvals (according to type)

Ordering information

Example: 67 series solar relay, single PCB terminals, 2 pole NO, ≥ 3 mm contact gap.

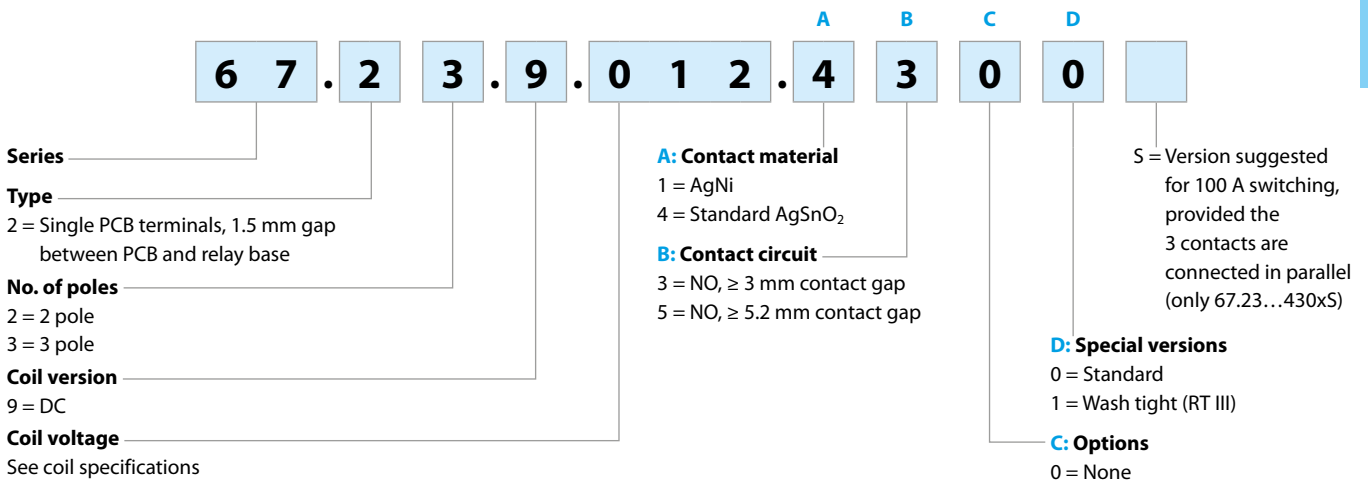

Technical data

Insulation according to EN 61810-1				
Nominal voltage of supply system	V AC	400/690 3-phase	400 1-phase	230/400
Rated insulation voltage	V AC	630	400	400
Pollution degree		3		
Insulation between coil and contact set				
Type of Insulation		Reinforced		
Overvoltage category		III		
Rated impulse voltage	kV (1.2/50 μs)	6		
Dielectric strength	V AC	4000		
Insulation between adjacent contacts				
Type of Insulation		Basic		
Overvoltage category		III		
Rated impulse voltage	kV (1.2/50)μs	6		
Dielectric strength	V AC	2500		
Insulation between open contacts				
Type of disconnection		Micro-disconnection*		Full-disconnection
Overvoltage category		—		III
Rated impulse voltage	kV (1.2/50)μs	—		4
Dielectric strength	V AC	2500 (67.xx-x300)/3000 (67.xx-x500)		
Insulation between coil terminals				
Rated impulse voltage (surge) differential mode (according to EN 61000-4-5)	kV(1.2/50 μs)	4		
Other data				
Bounce time: NO	ms	2		
Vibration resistance (10...150)Hz: NO	g	15		
Shock resistance	g	35		
Power lost to the environment	without contact current	W	1.7 (67.xx-x300)/2.7 (67.xx-x500)	
	with rated current	W	8.5 (67.xx-x300)/9.5 (67.xx-x500)	
Recommended distance between relays mounted on PCB	mm	≥ 20		
Short circuit protection				
Rated conditional short circuit current	kA	5		
Back-up fuse for motor load	A	30 (delayed type)		

* with overvoltage category II: Full-disconnection

Contact specification

F 67 - Electrical life v contact current (AC1/AC7a load)

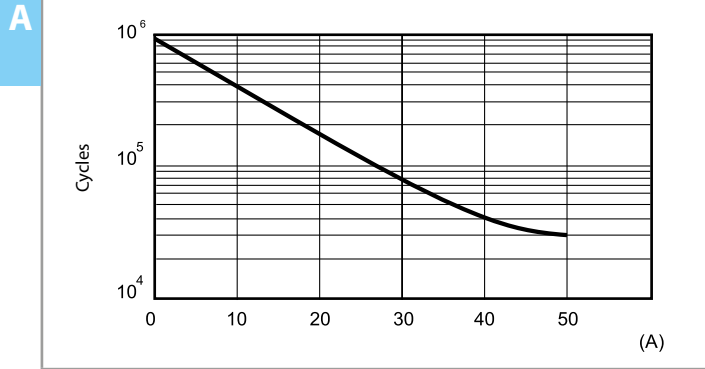

H 67 - Maximum DC breaking capacity (67.xx-x300)

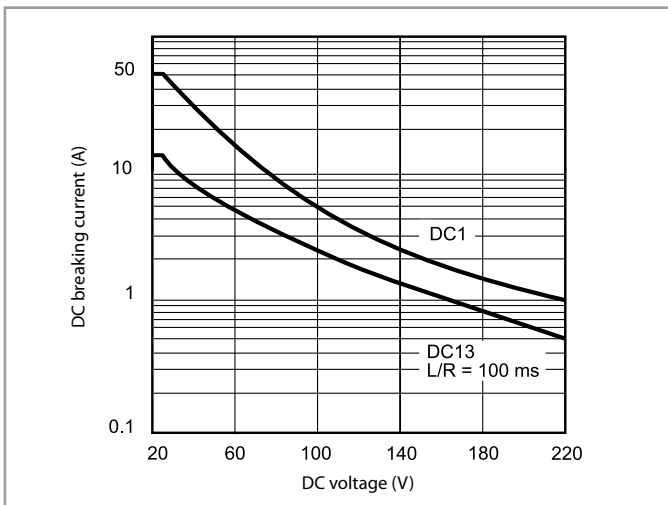

When switching a resistive (DC1) or inductive (DC13) load having voltage and current values under the corresponding curve, an electrical life of > 30000 cycles can be expected.

H 67 - Maximum DC breaking capacity (67.xx-x500)

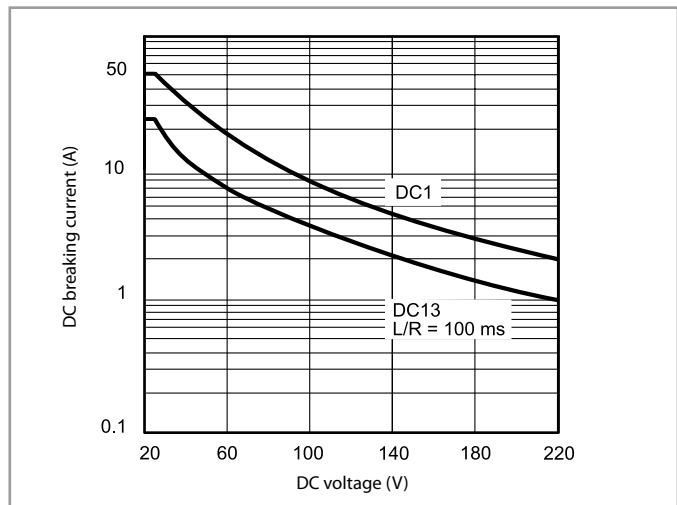

When switching a resistive (DC1) or inductive (DC13) load having voltage and current values under the corresponding curve, an electrical life of > 30000 cycles can be expected.

Connection of contacts in parallel

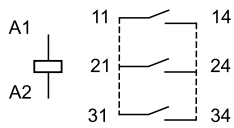

Connecting in parallel the contacts, with appropriate dimensioning of tracks on PC board, allow the relays to carry and switch loads up to 100 A:
 - 100 A, with 67.23...4300S version
 - 80 A, with 67.23...1300 version

Coil specifications

DC coil data, 67.xx-x300

Nominal voltage U_N	Coil code	Operating range (@ 70 °C max)		Holding voltage U_h	Resistance R	Rated coil consumption I at U_N I_N
		U_{min}	U_{max}			
V		V	V	V	Ω	mA
5	9.005	4.5	5.5	1.6	14.7	340
6	9.006	5.4	6.6	1.9	21.5	279
8	9.008	7.2	8.8	2.6	37.6	213
12	9.012	10.8	13.2	3.8	85	141
24	9.024	21.6	26.4	7.7	340	71
48	9.048	43.2	52.8	15.4	1355	35
60	9.060	54	66	19.2	2120	28
110	9.110	99	121	35.2	7120	15

DC coil data, 67.xx-x500

Nominal voltage U_N	Coil code	Operating range (@ 60 °C max)		Holding voltage U_h	Resistance R	Rated coil consumption I at U_N I_N
		U_{min}	U_{max}			
V		V	V	V	Ω	mA
5	9.005	4.5	5.5	1.25	9.3	538
6	9.006	5.4	6.6	1.5	13.5	444
8	9.008	7.2	8.8	2	23.7	338
12	9.012	10.8	13.2	3	53.5	224
24	9.024	21.6	26.4	6	213	113
48	9.048	43.2	52.8	12	855	56
60	9.060	54	66	15	1335	45
110	9.110	99	121	27.5	4500	24

R 67 - Operating range v ambient temperature, 67.xx-x300
with standard (continuous) coil energization (-40...+70)°C

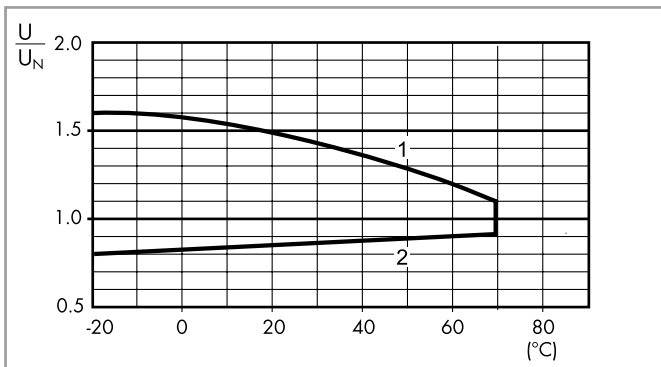

- 1 - Max. permitted coil voltage.
- 2 - Min. pick-up voltage with coil at ambient temperature.

Energy saving mode

In some applications, such as photovoltaic inverters, it may be necessary to minimize the overall relay power dissipation and to permit use at higher ambient temperature levels (up to 85 °C). This can be achieved by initially applying a coil voltage within the Energy saving mode Operating range (see diagram to the right) and then rapidly (< 1 s) reducing the coil voltage to a level within the Holding voltage range. The lower the Holding voltage, the lower is the continuous power dissipation of the coil (0.17 W minimum).

Coil voltages as high as 2.5 U_N may be used, when necessary, to reduce the contact operate time.

R 67 - Operating range v ambient temperature, 67.xx-x500
with standard (continuous) coil energization (-40...+60)°C

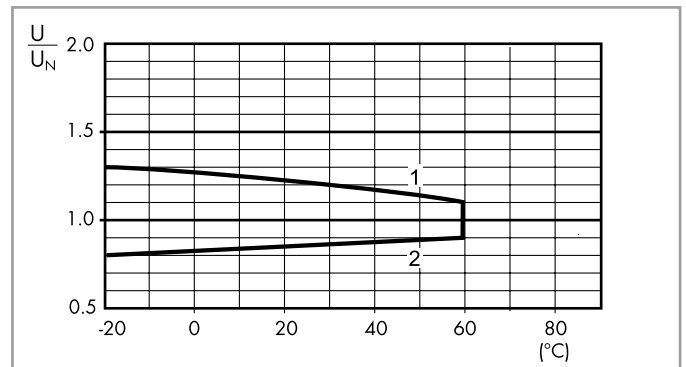

- 1 - Max. permitted coil voltage.
- 2 - Min. pick-up voltage with coil at ambient temperature.

R 67 - Operating range v ambient temperature, 67.xx-x300/x500
in energy saving mode (-40...+85)°C

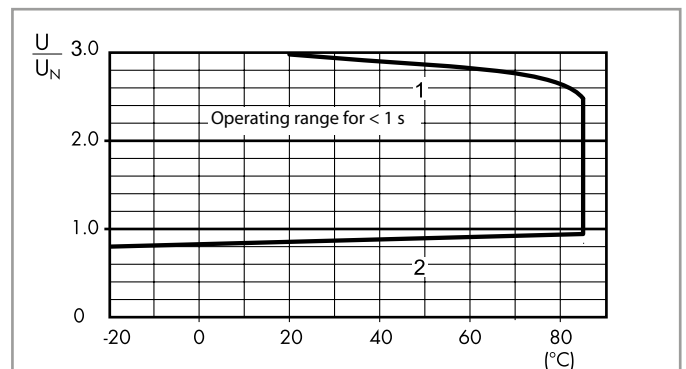

- 1 - Max. permitted coil voltage.
- 2 - Min. pick-up voltage with coil at ambient temperature.

Outline drawings

Type 67.22

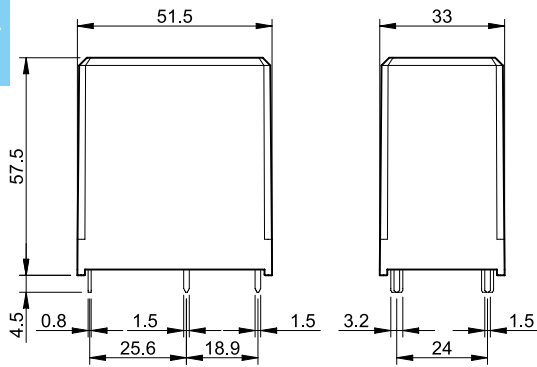

Type 67.23

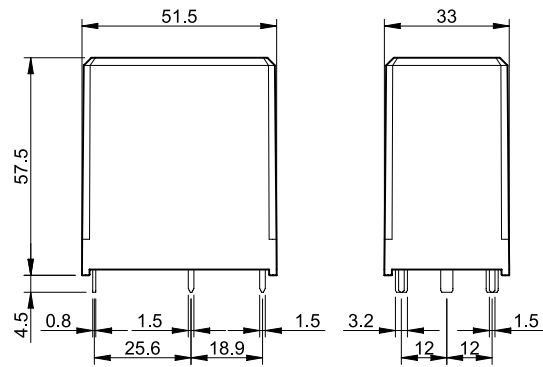

Bistable relay 8 A



Power
Plants



Panels for
electrical
distribution



Control
panels



Automatic
warehouses



Bistable relay for control and signaling
RB.14 35 mm rail (EN 60715) mount
RB.22 11 pin socket type 90.21 mount

- 2 or 4 pole changeover contact
- DC voltage
- 2 coil type
- SET and RESET signals
- LED command status indication
- Cadmium Free contact material

RB.14/22
Screw terminal



RB.14

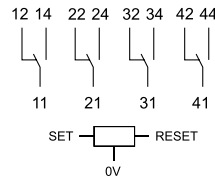

RB.22

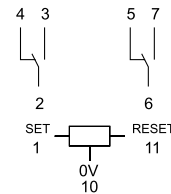

For outline drawings see page 7

Contact specification			
Contact configuration		4 CO (4PDT)	2 CO (DPDT)
Rated current/Maximum peak current	A	8/15	8/15
Rated voltage/ Maximum switching voltage	V AC	250/400	250/400
Rated load AC1	VA	2000	2000
Rated load AC15	VA	350	350
Single phase motor rating (230 V AC)	kW	0.37	0.37
Breaking capacity DC1: 30/110/220 V	A	8/0.3/0.12	8/0.3/0.12
Minimum switching load	mW (V/mA)	300 (5/5)	300 (5/5)
Standard contact material		AgSnO ₂	AgSnO ₂
Coil specification			
Nominal voltage (U _N)	V DC	24 - 48 - 110...125 - 220...250	24 - 110...125 - 220...250
Rated power DC	W	7	4
Operating range	V DC	(0.8...1.1)U _N	(0.8...1.1)U _N
Technical data			
Mechanical life DC	cycles	2 · 10 ⁶	2 · 10 ⁶
Electrical life at rated load AC1	cycles	100 · 10 ³	100 · 10 ³
Operate/release time SET/RESET	ms	10/5	10/5
Insulation between coil and contacts (1.2/50 μs)	kV	6 (8 mm)	4 (8 mm)
Dielectric strength between open contacts	V AC	1000	1000
Ambient temperature range	°C	-40...+55	-40...+55
Protection category		IP 20	IP 20
Approvals relay (according to type)		CE EAC	

Ordering information

Example: RB series, bistable relay, 4 CO, 125 V DC coil, 35 mm rail (EN 60715) mount.

A

R B . 1 4 . 9 . 1 2 5 . 0 0 0 0

Series ————

Type
1 = Modular version

No. of poles
4 = 4 CO

Coil version
9 = DC

Coil voltage
024 = 24 V DC
048 = 48 V DC
125 = 110...125 V DC
250 = 220...250 V DC

Options
0000 = Modular version 35 mm rail (EN 60715)

Codes/supply voltages
RB.14.9.024.0000
RB.14.9.048.0000
RB.14.9.125.0000
RB.14.9.250.0000

Example: RB series, bistable relay, 2 CO, 125 V DC coil, 11 pin socket type 90.21 mount.

R B . 2 2 . 9 . 1 2 5 . 9 0 2 1

Series ————

Type
2 = 11 pin socket type 90.21 mount

No. of poles
2 = 2 CO

Coil version
9 = DC

Coil voltage
024 = 24 V DC
125 = 110...125 V DC
250 = 220...250 V DC

Options
9021 = Version plug-in 90.21 socket
0000 = Version relay only

Codes/supply voltages
RB.22.9.024.0000
RB.22.9.024.9021
RB.22.9.125.0000
RB.22.9.125.9021
RB.22.9.250.0000
RB.22.9.250.9021

Technical data

Insulation according to EN 61810-1		
	2 CO	4 CO
Nominal voltage of supply system	V AC 230/400	230/400
Rated insulation voltage	V AC 250	250
Pollution degree	2	2
Insulation between coil and contact set		
Type of insulation	Reinforced (8 mm)	Reinforced (8 mm)
Overvoltage category	III	III
Rated impulse voltage	kV (1.2/50 μs) 4	6
Dielectric strength	V AC 2000	3000
Insulation between adjacent contacts		
Type of insulation	Basic	Basic
Overvoltage category	III	III
Rated impulse voltage	kV (1.2/50 μs) 4	4
Dielectric strength	V AC 2000	2500
Insulation between open contacts		
Type of disconnection	Micro-disconnection	Micro-disconnection
Dielectric strength	V AC/kV (1.2/50 μs) 1000/1.5	1000/1.5
Conducted disturbance immunity		
Burst (5...50)ns, 5 kHz, on A1 - A2 according to EN 61000-4-4	level 4 (4 kV)	
Surge (1.2/50 μs) on A1 - A2 (differential mode) according to EN 61000-4-5	level 3 (2 kV)	
Other data		
Bounce time: SET (NO) / RESET (NC)	ms	3/6
Vibration resistance (5...55)Hz: NO/NC	g	3/6
Shock resistance	g	15
Max cable length for push-button connection	m	100
Terminals		
	Screw terminal	
	Solid and stranded cable	
Max. wire size	mm ²	1 x 2.5 / 2 x 1.5
	AWG	1 x 14 / 2 x 16

Contact specification

RB - Maximum DC1 breaking capacity

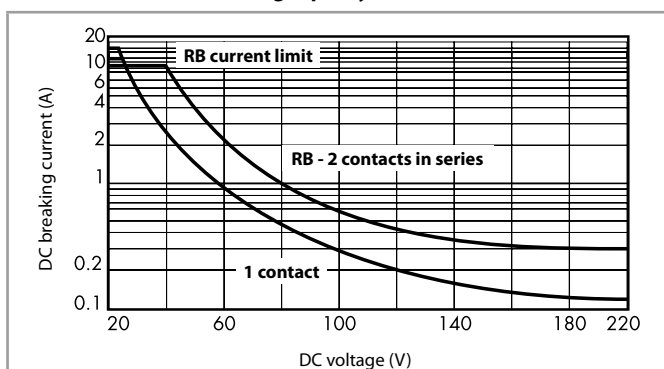

- When switching a resistive load (DC1) having voltage and current values under the curve, an electrical life of $\geq 100 \cdot 10^3$ can be expected.
- In the case of DC13 loads, the connection of a diode in parallel with the load will permit a similar electrical life as for a DC1 load.
Note: the release time for the load will be increased.

Coil specifications - Type RB.14

DC coil data

Nominal voltage U_N V	Coil code	Operating range		Rated coil consumption I at U_N mA	Rated power W
		U_{min} V	U_{max} V		
24	9.024	19.2	26.4	290	7
48	9.048	38.4	52.8	150	7
110...125	9.125	88	137.5	60	7
220...250	9.250	176	275	30	7

Coil specifications - Type RB.22

DC coil data

Nominal voltage U_N V	Coil code	Operating range		Rated coil consumption I at U_N mA	Rated power W
		U_{min} V	U_{max} V		
24	9.024	19.2	26.4	170	4
110...125	9.125	88	137.5	35	4
220...250	9.250	176	275	18	4

Wiring diagrams

A

Type RB.14

Connection for only local push-buttons enable
EN = Enable - Positive voltage
0V = Negative voltage

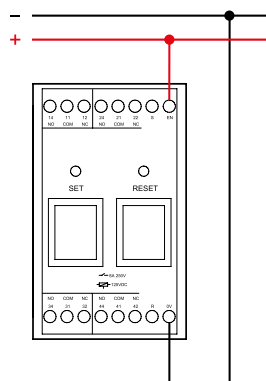

Type RB.14

Connection for remote push-buttons enable

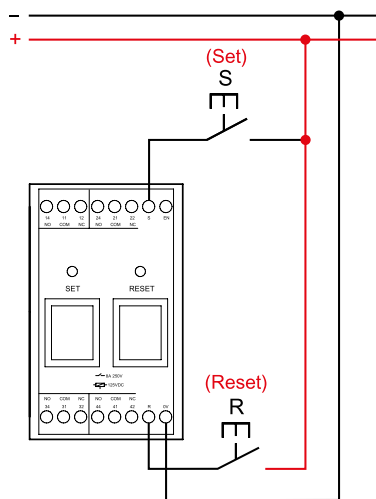

Type RB.14

Connection for local and remote push-buttons enable

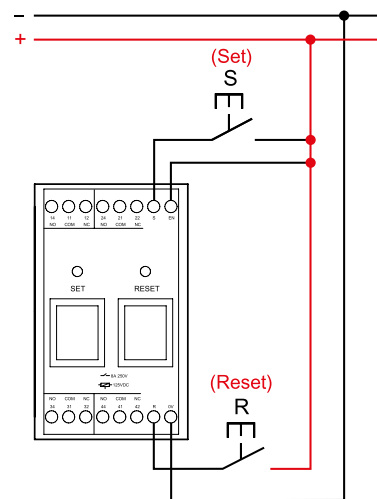

Type RB.22

Connection for only local push-buttons enable
EN = Enable - Positive voltage
0V = Negative voltage

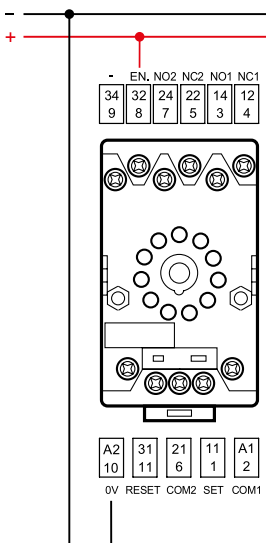

Type RB.22

Connection for remote push-buttons enable

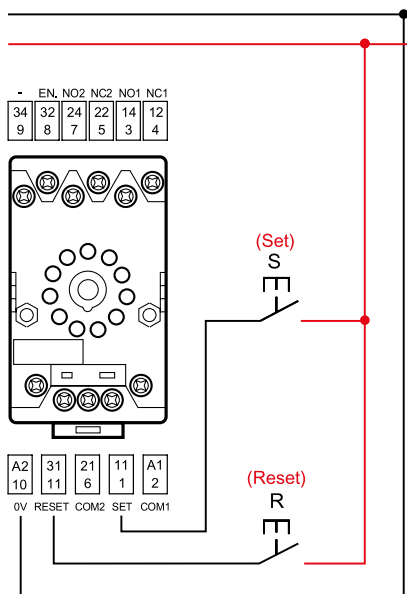

Type RB.22

Connection for local and remote push-buttons enable

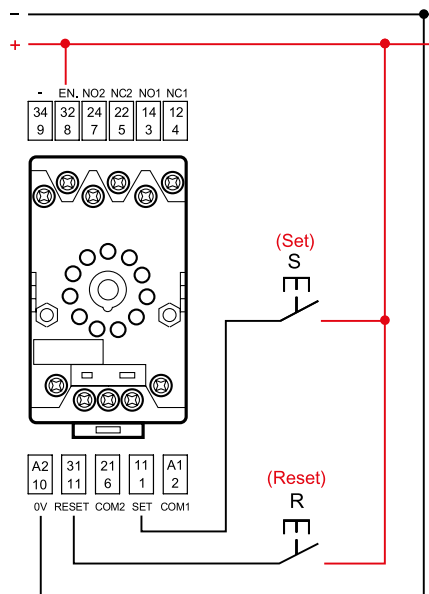

Functions

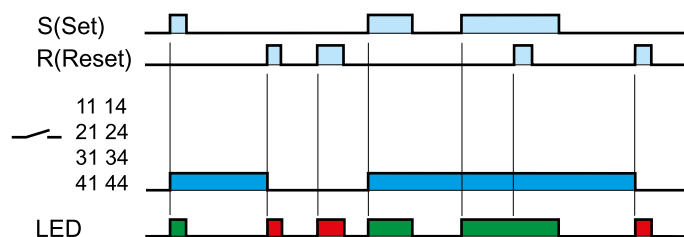

Outline drawing

RB.14
Screw terminal

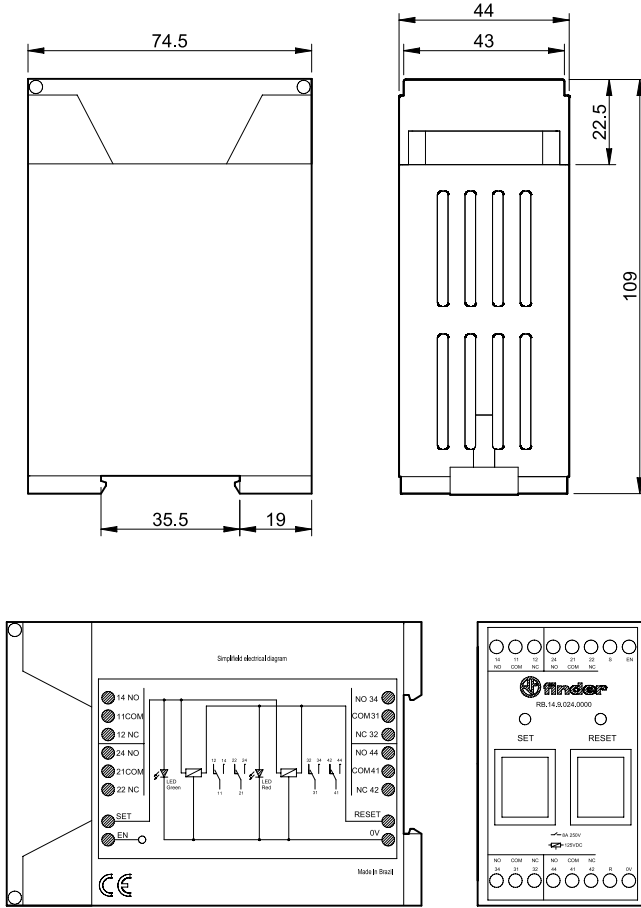

RB.22
Screw terminal

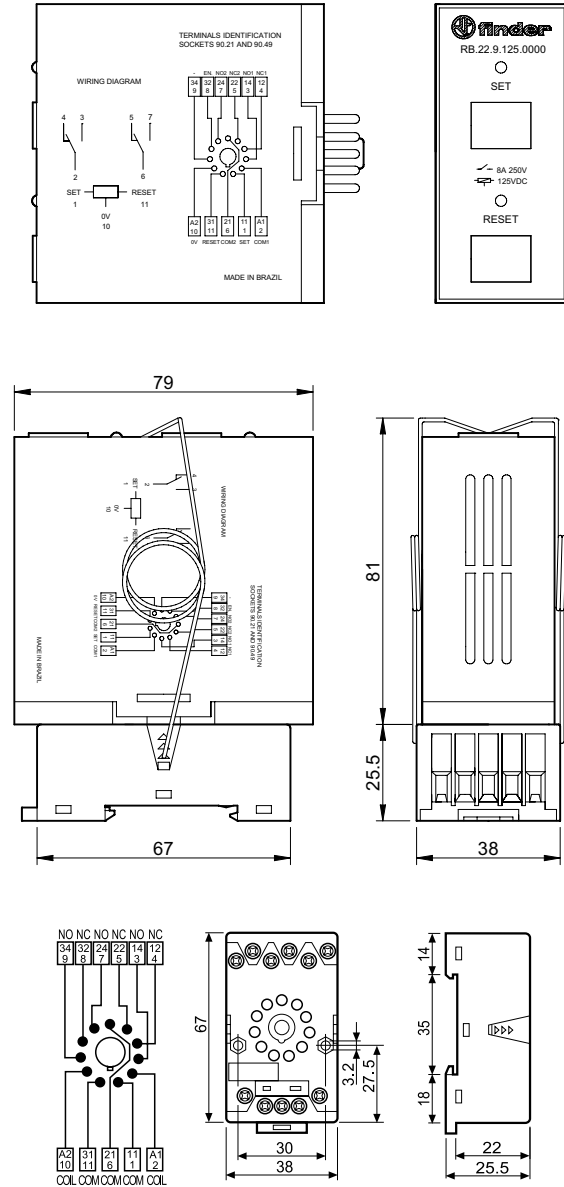

Fast relay module 8 A



Power
Plants



Panels for
electrical
distribution



Control
panels



Control and
management
of electric
power



Fast relay module

RR.14 35 mm rail (EN 60715) mount
RR.24 11 pin socket type 90.21 mount

- 4 pole changeover or 3 NO + 1 changeover contacts
- DC voltage
- Operate time ≤ 3 ms
- LED command status indication
- 35 mm rail (EN 60715) mount
- 11 pin socket type 90.21 mount

RR.14/24
Screw terminal



RR.14

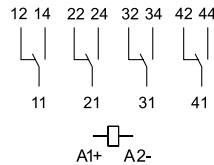

RR.24

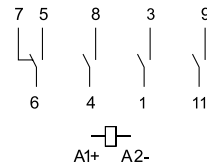

For outline drawings see page 7

Contact specification			
Contact configuration		4 CO (4PDT)	3 NO (SPST-NO) + 1 CO (SPDT)
Rated current/Maximum peak current	A	8/15	8/15
Rated voltage/ Maximum switching voltage	V AC	250/400	250/400
Rated load AC1	VA	2000	2000
Rated load AC15	VA	400	400
Single phase motor rating (230 V AC)	kW	0.3	0.3
Breaking capacity DC1: 30/110/220 V	A	8/0.3/0.12	8/0.3/0.12
Minimum switching load	mW (V/mA)	300 (5/5)	300 (5/5)
Standard contact material		AgCdO	AgCdO
Coil specification			
Nominal voltage (U_N)	V DC	24 - 48 - 110...125 - 220...250	24 - 110...125 - 220...250
Rated power DC	W	< 5	< 3
Operating range	V DC	(0.8...1.1) U_N	(0.8...1.1) U_N
Technical data			
Mechanical life DC	cycles	$10 \cdot 10^6$	$10 \cdot 10^6$
Electrical life at rated load AC1	cycles	$100 \cdot 10^3$	$100 \cdot 10^3$
Operate/release time	ms	2.9/2.5	3/5
Insulation between coil and contacts (1.2/50 μ s)	kV	6 (8 mm)	4 (8 mm)
Dielectric strength between open contacts	V AC	1000	1000
Ambient temperature range	$^{\circ}$ C	-40...+55	-40...+55
Protection category		IP 20	IP 20
Approvals relay (according to type)		CE EAC	

Ordering information

Example: RR series, fast relay module, 4 CO, 125 V DC coil, 35 mm rail (EN 60715) mount.

A

RR.14.9.125.0000

Series
RR

Type
1 = Modular version

No. of poles
4 = 4 CO

Coil version
9 = DC

Coil voltage
024 = 24 V DC
048 = 48 V DC
125 = 110...125 V DC
220 = 220 V DC
250 = 250 V DC

Options
0000 = Modular version 35 mm rail (EN 60715)

Codes/supply voltages
RR.14.9.024.0000
RR.14.9.048.0000
RR.14.9.125.0000
RR.14.9.220.0000
RR.14.9.250.0000

Example: RR series, fast relay module, 3 NO + 1 CO, 125 V DC coil, 11 pin socket type 90.21 mount.

RR.24.9.125.9021

Series
RR

Type
2 = Plug-in version

No. of poles
4 = 3 NO + 1 CO

Coil version
9 = DC

Coil voltage
024 = 24 V DC
125 = 110...125 V DC
250 = 220...250 V DC

Options
9021 = Relay + 90.21 sockets
0000 = Only Relay

Codes/supply voltages
RR.24.9.024.0000
RR.24.9.024.9021
RR.24.9.125.0000
RR.24.9.125.9021
RR.24.9.250.0000
RR.24.9.250.9021

Technical data

Insulation according to EN 61810-1		RR.14	RR.24
		4 CO	3 NO + 1 CO
Nominal voltage of supply system	V AC	230/400	230/400
Rated insulation voltage	V AC	250	250
Pollution degree		2	2
Insulation between coil and contact set			
Type of insulation		Reinforced (8 mm)	Reinforced (8 mm)
Overvoltage category		III	III
Rated impulse voltage	kV (1.2/50 µs)	6	4
Dielectric strength	V AC	3500	2000
Insulation between adjacent contacts			
Type of insulation		Basic	Basic
Overvoltage category		II	II
Rated impulse voltage	kV (1.2/50 µs)	2.5	2.5
Dielectric strength	V AC	2000	2000
Insulation between open contacts			
Type of disconnection		Micro-disconnection	Micro-disconnection
Dielectric strength	V AC/kV (1.2/50 µs)	1000/1.5	1000/1.5
Conducted disturbance immunity			
Burst (5...50)ns, 5 kHz, on A1 - A2 according to EN 61000-4-4		level 3 (2 kV)	
Surge (1.2/50 µs) on A1 - A2 (differential mode) according to EN 61000-4-5		level 3 (2 kV)	
Other data			
Bounce time: NO/NC	ms	1.3/5.1	
Vibration resistance (5...55)Hz: NO/NC	g	15/3	
Shock resistance	g	13	
Terminals		Screw terminal	
		Solid and stranded cable	
Max. wire size	mm ²	1 x 2.5 / 2 x 1.5	
	AWG	1 x 14 / 2 x 16	

Contact specification

RR - Electrical life (AC) v contact current

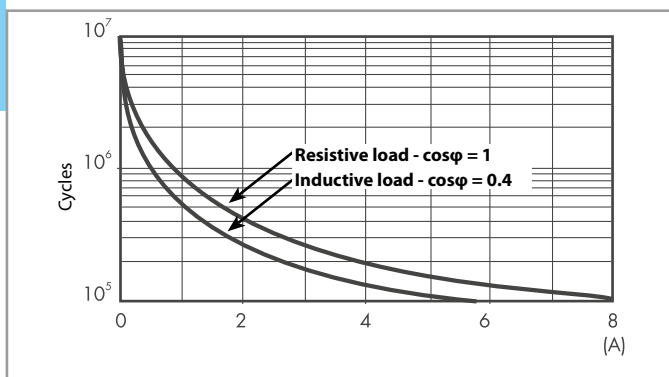

RR - Maximum DC1 breaking capacity

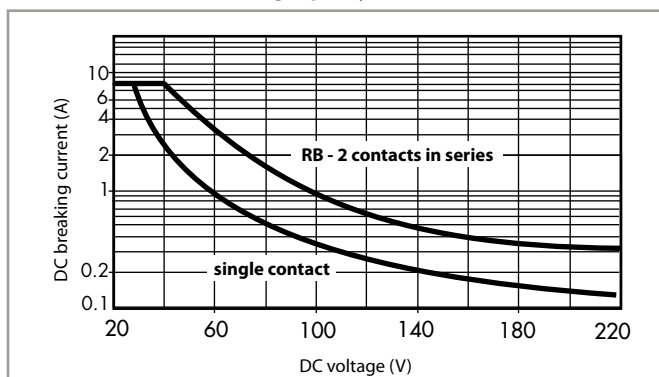

- When switching a resistive load (DC1) having voltage and current values under the curve, an electrical life of $\geq 100 \cdot 10^3$ can be expected.
- In the case of DC13 loads, the connection of a diode in parallel with the load will permit a similar electrical life as for a DC1 load.
Note: the release time for the load will be increased.

Coil specifications - Type RR.14

DC coil data

Nominal voltage	Coil code	Operating range		Holding voltage	Must drop-out voltage	Rated power	Rated coil consumption
		U_{\min}	U_{\max}				
U_N		V	V	V	V	W	I at U_N
V		V	V	V	V	W	mA
24	9.024	19.2	26.4	15	2.8	4.8	200
48	9.048	38.4	52.8	30	3	3.8	80
110...125	9.125	88	137.5	80	12	3.8	30
220	9.220	176	242	150	20	4.0	18
250	9.250	200	275	160	22	3.8	15

Coil specifications - Type RR.24

DC coil data

Nominal voltage	Coil code	Operating range		Holding voltage	Must drop-out voltage	Rated power	Rated coil consumption
		U_{\min}	U_{\max}				
U_N		V	V	V	V	W	I at U_N
V		V	V	V	V	W	mA
24	9.024	19.2	26.4	14	2.4	2.9	120
110...125	9.125	88	137.5	80	12	2.5	20
220...250	9.250	176	275	150	20	1.8	8

Outline drawing

RR.14
Screw terminal

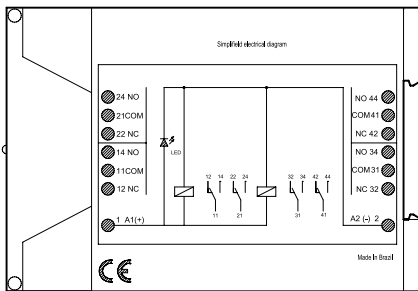
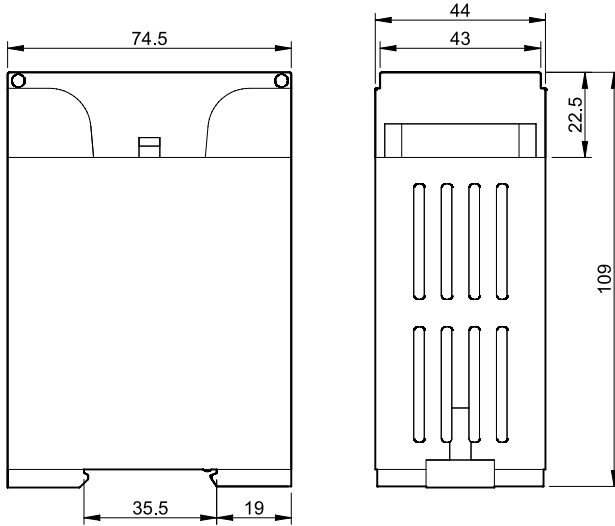

RR.24
Screw terminal

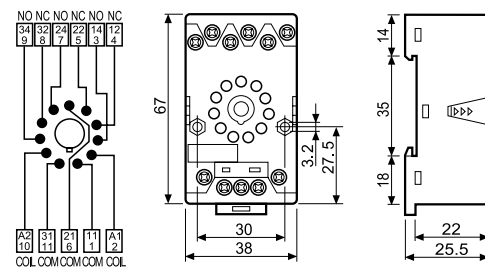
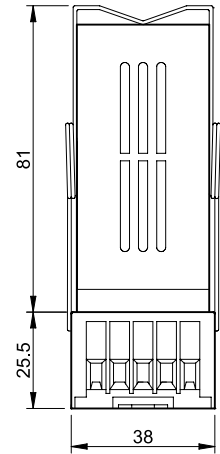
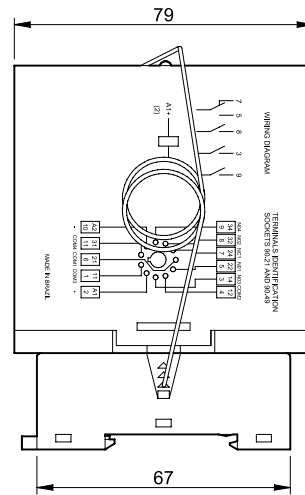
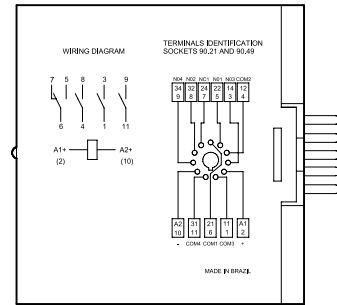



finder[®]
SWITCH TO THE FUTURE

99
SERIES

Coil indication and EMC suppression modules 90/92/94/95/96/97 series



Panels for electrical distribution



Control panels



Carousel warehouses



Escalators



Road / tunnel lighting



Hoists and cranes



99.02



Diagrams	Code	Functions
	<p>99.02.9.024.99 99.02.9.060.99 99.02.9.220.99</p>	<p>Green LED + diode module (standard polarity) Recovery diode modules + LED are used for DC only. The reverse voltage peaks of the coil are short circuited by the recovery diode (positive to terminal A1). The release time increases by an approximate factor from 3 to 5. If an increase of the release time is undesirable use a Varistor or RC module. The LED indicator lights up when the coil is energized.</p>
	<p>99.02.0.024.98 99.02.0.060.98 99.02.0.230.98</p>	<p>Green LED + Varistor module LED modules + Varistor are used for both AC and DC coils. The reverse voltage peaks of the relay coil are limited by the Varistor to approximately 2.5 times the nominal voltage of the supply. When using DC coils it is essential that positive is connected to terminal A1. The relay release time increases insignificantly.</p>
	<p>99.02.0.024.59 99.02.0.060.59 99.02.0.230.59</p>	<p>Green LED module LED modules are used for AC and DC. The LED indicator lights up when the coil is energized. When using DC it is essential that positive is connected to terminal A1.</p>
	<p>99.02.3.000.00</p>	<p>Diode module (standard polarity) Recovery diode modules are used for DC only. The reverse voltage peaks of the coil are short circuited by the recovery diode (positive to terminal A1). The release time increases by an approximate factor from 3 to 5. If an increase of the release time is undesirable use a Varistor or RC module.</p>
	<p>99.02.0.024.09 99.02.0.060.09 99.02.0.230.09</p>	<p>RC module RC circuit modules are used for AC and DC coils. The reverse voltage peaks of the coil are limited by the RC module to approximately 2.5 times the nominal voltage of the supply. The relay release time increases insignificantly.</p>
	<p>99.02.8.230.07</p>	<p>Residual current bypass module Bypass modules are advisable if 110 or 230 V AC relays show any tendency to fail to release. Failure to release can be caused by residual currents from AC proximity switches or inductive coupling caused through long parallel lying AC control lines.</p>

Voltage-current characteristic when switching a resistive load (fig. 1).

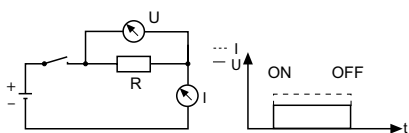

Voltage-current characteristic when switching a relay coil (fig. 2).

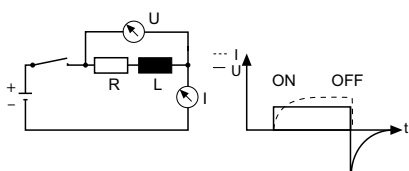

Switching Relay Coils.

When switching a resistive load, the current follows the phase of the voltage directly (Fig 1).

When switching relay coils the current and voltage waveforms are different due to the inductive nature of the coil (Fig 2). A brief explanation of this mechanism is as follows.

On energising the coil, the build up of the magnetic field gives rise to counter electromotive forces which in turn delay the rise in coil current. On de-energisation, the sudden interruption of the coil current causes a sudden collapse of the magnetic field, which in turn induces a high voltage of reverse polarity across the coil. This reverse polarity voltage peak can reach a value typically 15 times higher than the supply voltage, and as a consequence can disturb or destroy electronic devices.

To counteract this potentially damaging effect, relays coils can be suppressed with a Diode, a Varistor (voltage dependent resistor) or a RC (resistor/capacitor) module – dependent on the operating voltage. (See above for descriptions of the various Modules available.)

Whilst the above description is based on the working of a DC coil, the reverse polarity voltage peak on de-energisation applies similarly to AC coils. However, when energising AC coils there will also be a coil inrush current of 1.3 to 1.7 times the nominal coil current – dependent on coil size. If coils are fed via a transformer (and particularly if several are energised at the same time) then this may need to be taken into account when calculating the VA rating of the transformer.



finder[®]
SWITCH TO THE FUTURE

38
SERIES

Relay interface modules 0.1 - 2 - 3 - 5 - 6 - 8 - 16 A



Bottling plant



Packaging machines



Control panels



Traffic light controls



Vending machines



Programmable controllers







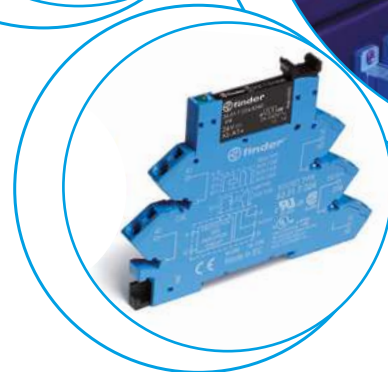
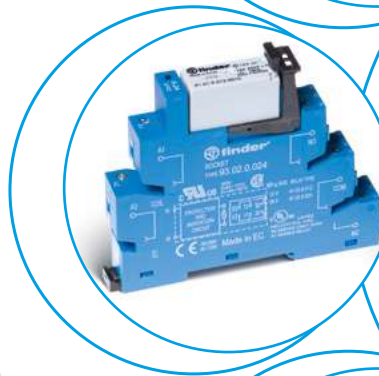
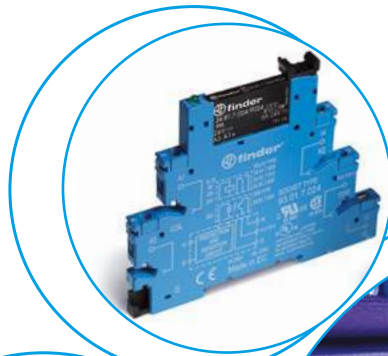

Panels for electrical distribution

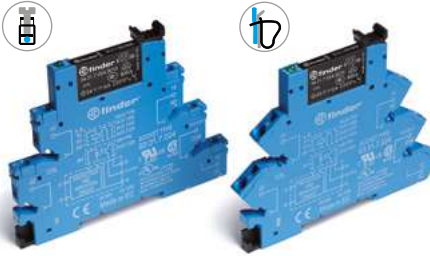

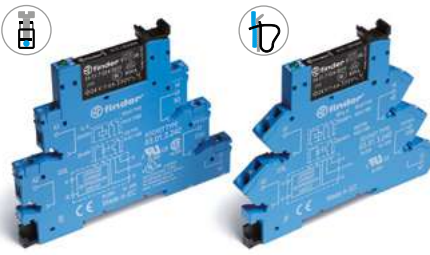
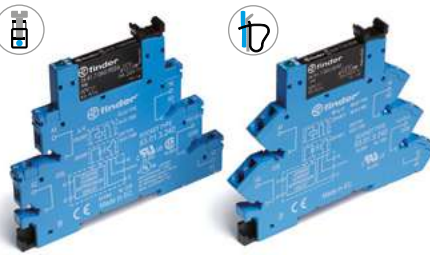
Labelling machines



<p>Common features</p> <ul style="list-style-type: none"> • Instant ejection of relay by plastic retaining clip • Integral coil indication and protection circuit • 35 mm rail (EN 60715) mounting 	<p>EMR Electromechanical Relays</p>	<p>SSR Solid State Relays</p>
<p>6.2 mm wide</p> <ul style="list-style-type: none"> • EMR - DC, AC or AC/DC coil versions • SSR - DC or AC/DC input versions • Screw and Screwless terminal options 	<p>38.51/38.61</p>  <ul style="list-style-type: none"> • 1 CO - 6 A/250 V AC <p>Page 1</p>	<p>38.81/38.91</p>  <ul style="list-style-type: none"> • Single solid state output: Options 0.1 A/48 V DC, 6 A/24 V DC, 2 A/240 V AC • Silent, high speed switching • Long electrical life <p>Page 2</p>
<p>6.2 mm wide</p> <ul style="list-style-type: none"> • Special coil/input leakage current suppression types • EMR - AC or AC/DC coil versions • SSR - AC or AC/DC input versions • Screw and Screwless terminal options 	<p>38.51.3... - 38.61.3...</p>  <ul style="list-style-type: none"> • 1 CO - 6 A/250 V AC <p>Page 1</p>	<p>38.81.3... - 38.91.3...</p>  <ul style="list-style-type: none"> • Single solid state output: Options 0.1 A/48 V DC, 6 A/24 V DC, 2 A/240 V AC • Silent, high speed switching • Long electrical life <p>Page 2</p>
<p>6.2 mm wide</p> <ul style="list-style-type: none"> • Timed Interface module • 4 functions & 4 time scales 0.1 s...6 h • EMR - AC/DC (12 or 24 V) supply versions • SSR - AC/DC (24 V) supply • Screw terminals 	<p>38.21</p>  <ul style="list-style-type: none"> • 1 CO - 6 A/250 V AC <p>Page 3</p>	<p>38.21...9024-8240</p>  <ul style="list-style-type: none"> • Single solid state output: Options 6 A/24 V DC, 2 A/240 V AC • Silent, high speed switching • Long electrical life <p>Page 3</p>
<p>14 mm wide</p> <ul style="list-style-type: none"> • 2 pole 8 A or 1 pole 16 A • EMR - DC or AC/DC coil versions • SSR - DC input versions • Screw and Screwless terminal options 	<p>38.01/38.52/38.11/38.62</p>  <ul style="list-style-type: none"> • 1 CO - 16 A/250 V AC • 2 CO - 8 A/250 V AC <p>Page 4</p>	<p>38.31/38.41</p>  <ul style="list-style-type: none"> • Single solid state output: Options 5 A/24 V DC, 3 A/240 V AC • Silent, high speed switching • Long electrical life <p>Page 5</p>

B

1 Pole - 6 A electromechanical relay interface modules, 6.2 mm wide.

Ideal interface for PLC and electronic systems

- Sensitive DC coil or AC/DC coil versions
- Integral coil indication and protection circuit
- Instant ejection of relay using plastic retaining clip
- UL Listing (certain relay/socket combinations)
- 35 mm rail (EN 60715) mounting

38.51/38.51.3
Screw terminal

38.61/38.61.3
Screwless terminal



* Special version for max ambient temperature +70 °C.

** Maximum ambient temperature limitations apply in the case of adjacent mounting of modules, where the coil is energised with a duty cycle of $\geq 50\%$ or where the ON time exceeds 1 hour:
 +55 °C: applies to groups limited to 2 adjacent modules and where each group is separated by an air gap ≥ 6.2 mm.
 +30 °C: applies to a group of more than 2 adjacent modules.

For outline drawing see page 13

Contact specification

Contact configuration

1 CO (SPDT)

1 CO (SPDT)

Rated current/
Maximum peak current

A

6/10

6/10

Rated voltage/
Maximum switching voltage

V AC

250/400

250/400

Rated load AC1

VA

1500

1500

Rated load AC15 (230 V AC)

VA

300

300

Single phase motor rating (230 V AC)

kW

0.185

0.185

Breaking capacity DC1: 30/110/220 V

A

6/0.2/0.12

6/0.2/0.12

Minimum switching load

mW (V/mA)

500 (12/10)

500 (12/10)

Standard contact material

AgNi

AgNi

Coil specification

Nominal voltage (U_N)

V AC/DC

12 - 24 - 48 - 60 - (110...125) - (220...240)**

(110...125)

—

V AC

(230...240)*

—

(230...240)

V DC

6 - 12 - 24 - 48 - 60 (non polarized)

—

—

Rated power AC/DC

VA (50 Hz)/W

See page 9

1/1

0.5/—

Operating range

AC/DC

(0.8...1.1) U_N

(94...138)V

—

AC

(184...264)V

—

(184...264)V

DC

(0.8...1.2) U_N

—

—

Holding voltage

AC/DC

0.6 U_N / 0.6 U_N

0.6 U_N / 0.6 U_N

Must drop-out voltage

AC/DC

0.1 U_N / 0.05 U_N

44 V

72 V

Technical data

Mechanical life AC/DC

cycles

$10 \cdot 10^6$

$10 \cdot 10^6$

Electrical life at rated load AC1

cycles

$60 \cdot 10^3$

$60 \cdot 10^3$

Operate/release time

ms

5/6

5/6

Insulation between coil and contacts (1.2/50 μ s)

kV

6 (8 mm)

6 (8 mm)

Dielectric strength between open contacts

V AC

1000

1000

Ambient temperature range ($U_N \leq 60$ V / > 60 V)

°C

-40...+70/-40...+55

-/-40...+55

Protection category

IP 20

IP 20

Approvals relay (according to type)



38.51/61

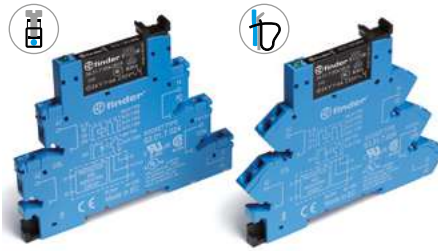

- 1 pole electromechanical relay
- Screw terminal and screwless terminal
- 35 mm rail (EN 60715) mounting

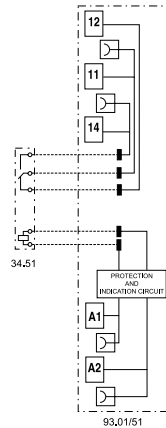

38.51.3/38.61.3

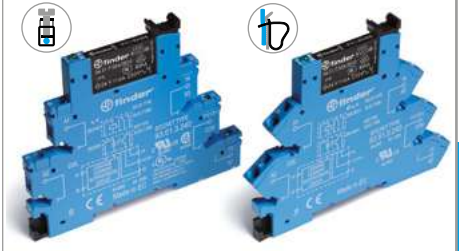

- Leakage current suppression
- 1 pole electromechanical relay
- Screw terminal and screwless terminal
- 35 mm rail (EN 60715) mounting

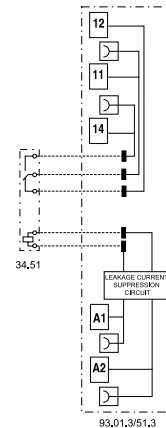

Single output - solid state relay interface modules, 6.2 mm wide.

Ideal interface for PLC and electronic systems

- DC, AC or AC/DC input versions
- Supplied with integral coil indication and protection circuit
- Silent, high switching speed and long electrical life
- Instant ejection of relay using plastic retaining clip
- UL Listing (certain relay/socket combinations)
- 35 mm rail (EN 60715) mounting

38.81/38.81.3
Screw terminal

38.91/38.91.3
Screwless terminal



38.81/38.91

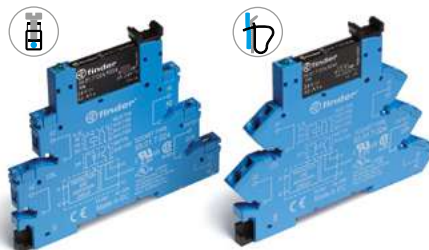

- AC or DC output switching
- SSR relay - DC input voltage
- Screw terminal and screwless terminal
- 35 mm rail (EN 60715) mounting

38.81.3/38.91.3

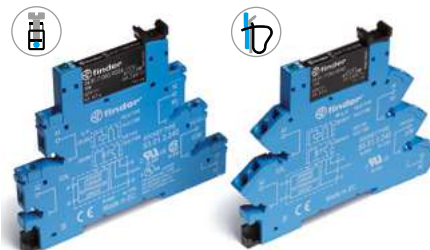

- Leakage current suppression
- AC or DC output
- SSR relay - AC or AC/DC input voltage
- Screw terminal and screwless terminal
- 35 mm rail (EN 60715) mounting

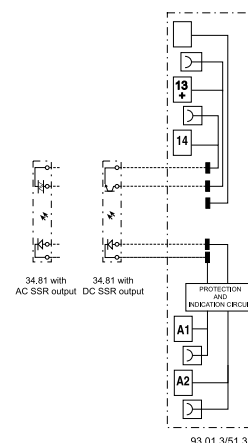
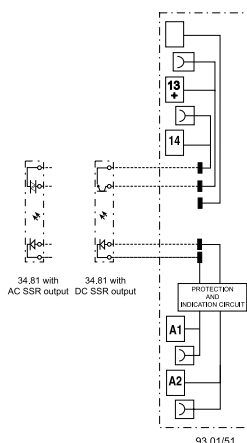

For outline drawing see page 13

Output specification

		1 NO (SPST-NO)			1 NO (SPST-NO)		
Contact configuration							
Rated current/ Maximum peak current (10 ms)	A	6/50	0.1/0.5	2/80	6/50	0.1/0.5	2/80
Rated voltage/ Maximum blocking voltage	V	24/33 DC	48/53 DC	240/— AC	24/33 DC	48/53 DC	240/— AC
Switching voltage range	V	(1.5...33)DC	(1.5...53)DC	(12...275)AC	(1.5...33)DC	(1.5...53)DC	(12...275)AC
Repetitive peak off-state voltage	V _{pk}	—	—	800	—	—	800
Minimum switching current	mA	1	0.05	35	1	0.05	35
Max. "OFF-state" leakage current	mA	0.001	0.001	1.5	0.001	0.001	1.5
Max. "ON-state" voltage drop	V	0.4	1	1.6	0.4	1	1.6

Input specification

Nominal voltage (U _N)	V AC	—			230...240		
	V DC	6 - 24 - 60			—		
	V AC/DC	(110...125) - (220...240)			110...125		
Operating range	V DC	See page 10			See page 10		
Control current	mA	See page 10			See page 10		
Release voltage	V DC	See page 10			See page 10		

Technical data

Operate/release time: ON/OFF (DC input)	ms	0.2/0.6	0.04/0.11	12/12	0.2/0.6	0.04/0.11	12/12
Dielectric strength between input/output	V AC	2500			2500		
Ambient temperature range	°C	-20...+55			-20...+55		
Environmental protection		IP20			IP20		

Approvals relay (according to type)



**Slim timed interface module, 6.2 mm wide.
1 pole, 6 A - electromechanical relay
1 output, 2 A DC or AC - solid state relay**

- Electromechanical or solid state output
- Multi-functions timer
- AC/DC supply
- 4 time scales from 0.1 s to 6 h
- Instant ejection of relay using plastic retaining clip
- 6.2 mm wide, 35 mm rail (EN 60715) mounting

38.21
Screw terminal



- 1 pole electromechanical output relay
- 12 or 24 V AC/DC supply
- Screw terminal
- 35 mm rail (EN 60715) mounting

- DC or AC solid state output relays
- 24 V AC/DC supply voltage
- Screw terminal
- 35 mm rail (EN 60715) mounting

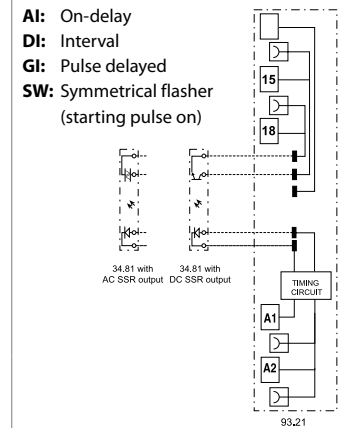
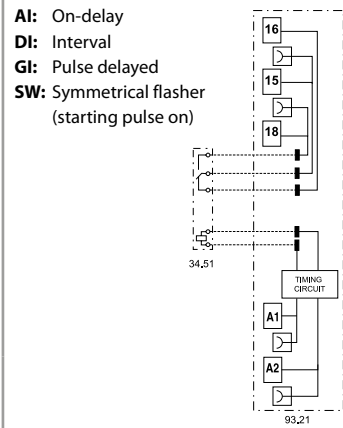

For outline drawing see page 13

Contact specification			
Contact configuration		1 CO (SPDT)	
Rated current/ Maximum peak current	A	6/10	
Rated voltage/ Maximum switching voltage	V AC	250/400	
Rated load AC1	VA	1500	
Breaking capacity DC1: 30/110/220 V	A	6/0.2/0.12	
Minimum switching load	mW (V/mA)	500 (12/10)	
Standard contact material		AgNi	
Output specification		DC output (...9024)	AC output (...8240)
Output configuration		1 NO (SPST-NO)	1 NO (SPST-NO)
Rated current/Maximum peak current	A	6/50	2/80
Rated voltage/ Maximum blocking voltage	V	(24/33)DC	(240/—)AC
Switching voltage range	V	(1.5...33)DC	(12...275)AC
Repetitive peak off-state voltage	V _{pk}	—	800
Minimum switching current	mA	1	35
Max. "OFF-state" leakage current	mA	0.001	1.5
Max. "ON-state" voltage drop	V	0.4	1.6
Supply specification			
Nominal voltage (U _N)	V AC (50/60 Hz)/DC	12 - 24	
Rated power	VA/W	0.5	
Operating range	AC	(0.8...1.1)U _N	
	DC	(0.8...1.1)U _N	
Technical data			
Specified time range		(0.1...3)s, (3...60)s, (1...20)min, (0.3...6)h	
Repeatability	%	± 1	
Recovery time	ms	≤ 50	
Setting accuracy-full range	%	5%	
Ambient temperature	°C	-40...+70	
Protection category		IP 20	
Approvals relay (according to type)			

Electromechanical relay interface modules, 14 mm wide.

38.01 and 38.11 - 1 Pole 16 A
38.52 and 38.62 - 2 Pole 8 A

Ideal interface for PLC and electronic systems

- Sensitive DC coil or AC/DC coil versions
- Integral coil indication and protection circuit
- Instant ejection of relay using plastic retaining clip
- UL Listing (certain relay/socket combinations)
- 35 mm rail (EN 60715) mounting

B

38.01/52
Screw terminal



38.11/62
Screwless terminal



38.01/38.11



- Screw terminal and screwless terminal
- 1 pole electromechanical relay
- 35 mm rail (EN 60715) mounting

38.52/38.62

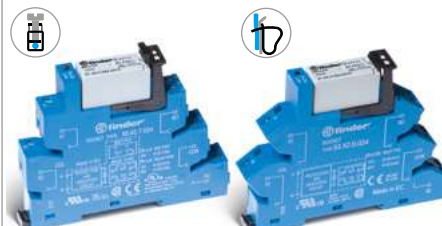

- Screw terminal and screwless terminal
- 2 pole electromechanical relay
- 35 mm rail (EN 60715) mounting

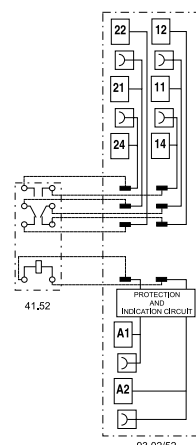
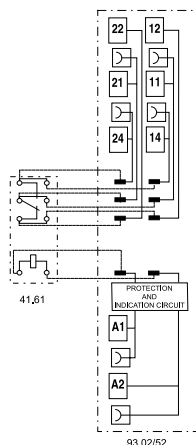

* For currents > 10 A, contact terminals must be connected in parallel (21 with 11, 24 with 14, 22 with 12).

For outline drawing see page 13

Contact specification

Contact configuration		1 CO (SPDT)	2 CO (DPDT)
Rated current/Maximum peak current	A	16*/30	8/15
Rated voltage/Maximum switching voltage	V AC	250/400	250/400
Rated load AC1	VA	4000	2000
Rated load AC15 (230 V AC)	VA	750	400
Single phase motor rating (230 V AC)	kW	0.5	0.3
Breaking capacity DC1: 30/110/220 V	A	16/0.3/0.12	8/0.3/0.12
Minimum switching load	mW (V/mA)	300 (5/5)	300 (5/5)
Standard contact material		AgNi	AgNi

Coil specification

Nominal voltage (U _N)	V AC/DC	24 - 60 - (110...125) - (220...240)	24 - 60 - (110...125) - (220...240)
	V AC	230...240	230...240
	V DC	12 - 24 - 60	12 - 24 - 60
Rated power AC/DC	VA (50 Hz)/W	See page 9	See page 9
Operating range	AC/DC	0.8...1.1	0.8...1.1
	DC	(0.8...1.2)U _N	(0.8...1.2)U _N
Holding voltage	AC/DC	0.6 U _N / 0.6 U _N	0.6 U _N / 0.6 U _N
Must drop-out voltage	AC/DC	0.1 U _N / 0.05 U _N	0.1 U _N / 0.05 U _N

Technical data

Mechanical life AC/DC	cycles	10 · 10 ⁶	10 · 10 ⁶
Electrical life at rated load AC1	cycles	50 · 10 ³	60 · 10 ³
Operate/release time	ms	8/10	8/10
Insulation between coil and contacts (1.2/50 μs)	kV	6 (8 mm)	6 (8 mm)
Dielectric strength between open contacts	V AC	1000	1000
Ambient temperature range (U _N ≤ 60 V / > 60 V)	°C	-40...+70 / -40...+55	-40...+70 / -40...+55
Protection category		IP 20	IP 20

Approvals relay (according to type)



Single output - solid state relay interface modules, 14 mm wide.

Ideal interface for PLC and electronic systems

- DC input versions
- Supplied with integral coil indication and protection circuit
- Silent, high switching speed and long electrical life
- Instant ejection of relay using plastic retaining clip
- UL Listing (certain relay/socket combinations)
- 35 mm rail (EN 60715) mounting

38.31
Screw terminal



38.41
Screwless terminal



38.31/38.41



- Screw terminal and screwless terminal
- AC or DC output switching
- SSR relay - DC input voltage
- 35 mm rail (EN 60715) mounting

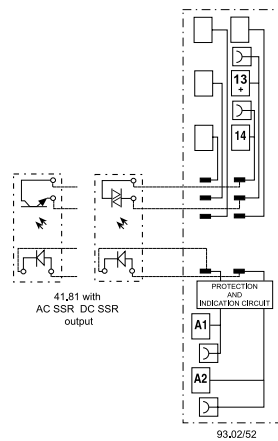

For outline drawing see page 13

Output specification

Contact configuration	1 NO (SPST-NO)	1 NO (SPST-NO)
Rated current/ Maximum peak current (10 ms)	A	5/40
Rated voltage/ Maximum blocking voltage	V	(24/35)DC
Switching voltage range	V	(1.5...24)DC
Repetitive peak off-state voltage	V _{pk}	600
Minimum switching current	mA	1
Max. "OFF-state" leakage current	mA	0.01
Max. "ON-state" voltage drop	V	0.3

Input specification

Nominal voltage (U _N)	V AC/DC	24
	V DC	12 - 24
Operating range	V DC	See page 10
Control current	mA	See page 10
Release voltage	V DC	See page 10

Technical data

Operate/release time: ON/OFF (DC input)	ms	0.05/0.25
Dielectric strength between input/output	V AC	2500
Ambient temperature range	°C	-20...+55
Environmental protection		IP20

Approvals relay (according to type)



B

Ordering information

Electromechanical relay - 1 or 2 Pole

Example: 38 series screw terminal relay interface module, 1 CO (SPDT), sensitive 12 V DC coil.

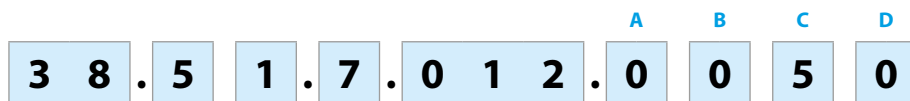

B

Series

Type

- 0 = Electromechanical 16 A relay, with screw terminal
- 1 = Electromechanical 16 A relay, with screwless terminal
- 2 = Timer multifunction (AI, DI, GI, SW), with screw terminal
- 5 = Electromechanical relay, with screw terminal
- 6 = Electromechanical relay, with screwless terminal

No. of poles

- 1 = 1 pole, 6 or 16 A
- 2 = 2 pole, 8 A

Coil version

- 0 = AC (50/60 Hz)/DC
- 3 = Leakage current suppression for (110...125)V AC/DC - (230...240)V AC
- 7 = Sensitive DC, (6, 12, 24, 48, 60)V only
- 8 = AC (50/60 Hz)

Coil voltage

See coil specifications

D: Special versions

0 = Standard

C: Options

- 5 = Standard DC
- 6 = Standard AC or AC/DC

B: Contact circuit

0 = CO (nPDT)

A: Contact material

- 0 = AgNi Standard
- 4 = AgSnO₂
- 5 = AgNi + Au

Selecting features and options: only combinations in the same row are possible.

Type	Coil version	A	B	C	D
38.01/11	7	0 - 4	0	5	0
38.01/11	0 - 8	0 - 4	0	6	0
38.51/61	7	0 - 4 - 5	0	5	0
38.51/61	0 - 3 - 8	0 - 4 - 5	0	6	0
38.52/62	7	0 - 5	0	5	0
38.52/62	0 - 8	0 - 5	0	6	0
38.21	0	0	0	6	0

Ordering information

Solid state relay - Single output - 6.2 & 14 mm wide

Example: 38 series screw terminal SSR relay interface module, 6.2 mm wide, 6 A output, 24 V DC input.

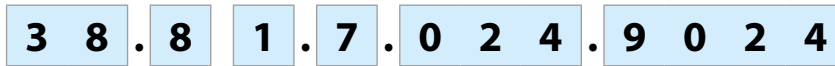

Series

Type

- 21 = Timer SSR 6.2 mm wide, with screw terminal
- 31 = SSR 14 mm wide, with screw terminal
- 41 = SSR 14 mm wide, with screwless terminal
- 81 = SSR 6.2 mm wide, with screw terminal
- 91 = SSR 6.2 mm wide, with screwless terminal

Input version

- 0 = AC/DC
- 3 = Leakage current suppression for (110...125)V AC/DC and (230...240)V AC SSR only
- 7 = DC, (6, 24, 60)V SSR only

Input voltage

See input specifications

Output version

- 9024 = 6 A - 24 V DC (38.21, 38.81 & 38.91)
- 9024 = 5 A - 24 V DC (38.31 & 38.41)
- 7048 = 0.1 A - 48 V DC (38.81 & 38.91)
- 8240 = 2 A - 240 V AC (38.21, 38.81 & 38.91)
- 8240 = 3 A - 240 V AC (38.31 & 38.41)

B

Selecting features and options: only combinations in the same row are possible.

Type	Input version	Output version
38.81/91	7	9024 - 7048 - 8240
38.81/91	0 - 3	9024 - 7048 - 8240
38.31/41	0 - 7	9024 - 8240
38.21	0	9024 - 8240

Technical data - 1 & 2 Pole Electromechanical Relays

Insulation

Insulation according to EN 61810-1	insulation rated voltage	V	250	400
	rated impulse withstand voltage	kV	4	4
	pollution degree		3	2
	overvoltage category		III	III

Insulation between coil and contacts (1.2/50 μ s)	kV	6 (8 mm)
Dielectric strength between open contacts	V AC	1000

Conducted disturbance immunity

Burst (5...50)ns, 5 kHz, on A1 - A2 according to EN 61000-4-4	level 4 (4 kV)
Surge (1.2/50 μ s) on A1 - A2 (differential mode) according to EN 61000-4-5	level 3 (2 kV)

Other data

		1 Pole 6 A	1 Pole 16 A - 2 Pole 8 A
Bounce time: NO/NC	ms	1/6	2/5
Vibration resistance (10...55)Hz: NO/NC	g	10/5	15/2
Power lost to the environment	without contact current	W	0.2 (12 V) - 0.9 (240 V)
	with rated current	W	0.5 (24 V) - 0.9 (240 V)
			1.3 (24 V) - 1.7 (240 V)

Terminals

Wire strip length	mm	10	10		
⊖ Screw torque	Nm	0.5	—		
Max. wire size		solid cable	stranded cable	solid cable	stranded cable
	mm ²	1 x 2.5 / 2 x 1.5	1 x 2.5 / 2 x 1.5	1 x 2.5	1 x 2.5
	AWG	1 x 14 / 2 x 16	1 x 14 / 2 x 16	1 x 14	1 x 14
		38.01 / 38.52	38.11 / 38.62		
Wire strip length	mm	10	10		
⊖ Screw torque	Nm	0.5	—		
Max. wire size		solid cable	stranded cable	solid cable	stranded cable
	mm ²	1 x 2.5 / 2 x 1.5	1 x 2.5 / 2 x 1.5	1 x 2.5	1 x 2.5
	AWG	1 x 14 / 2 x 16	1 x 14 / 2 x 16	1 x 14	1 x 14

Contact specification - 1 & 2 Pole Electromagnetic Relays

F 38 - Electrical life (AC) v contact current, 1 Pole 6 A

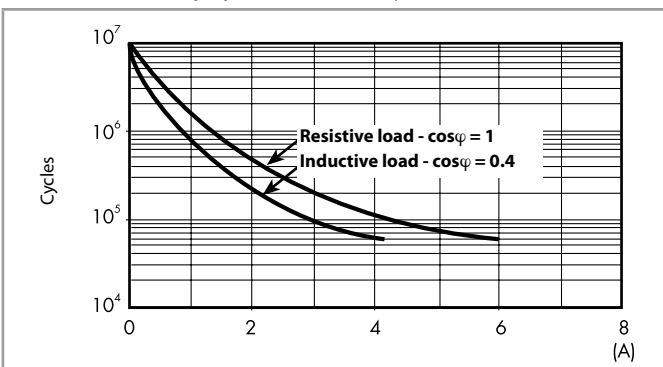

F 38 - Electrical life (AC) v contact current, 1 Pole 16 A and 2 Pole 8 A

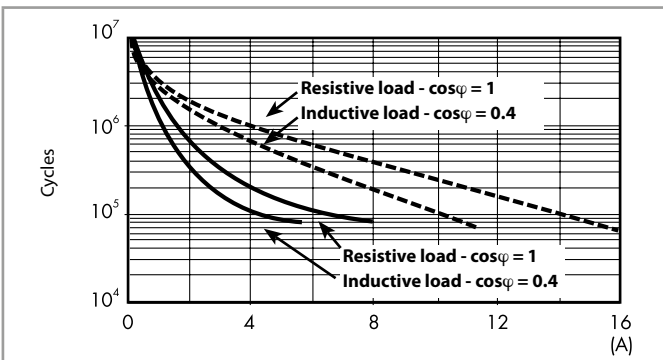

— : 2 Pole 8 A
 - - - : 1 Pole 16 A

H 38 - Maximum DC1 breaking capacity, 1 Pole 6 A

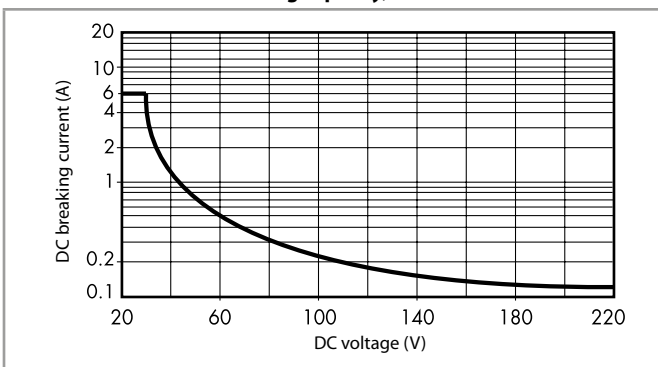

H 38 - Maximum DC1 breaking capacity, 1 Pole 16 A and 2 Pole 8 A

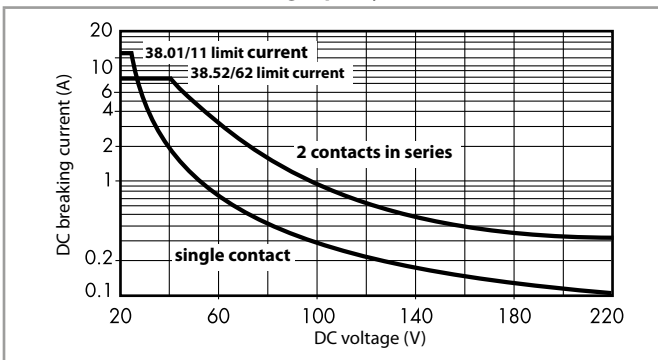

- When switching a resistive load (DC1) having voltage and current values under the curve, an electrical life of $\geq 60 \cdot 10^3$ (1 Pole) or $\geq 80 \cdot 10^3$ (2 Pole) can be expected.
- In the case of DC13 loads, the connection of a diode in parallel with the load will permit a similar electrical life as for a DC1 load. Note: the release time for the load will be increased.

Coil specifications - 1 Pole 6 A Electromechanical Relay

Coil data sensitive DC, 1 Pole

Nominal voltage U_N	Coil code	Operating range		Rated coil consumption I at U_N	Power consumption P at U_N
		U_{min}	U_{max}		
V		V	V	mA	W
6	7.006	4.8	7.2	35	0.2
12	7.012	9.6	14.4	15.2	0.2
24	7.024	19.2	28.8	10.4	0.3
48	7.048	38.4	57.6	6.3	0.3
60	7.060	48	72	7	0.4

Coil data AC/DC, 1 Pole

Nominal voltage U_N	Coil code	Operating range		Rated coil consumption I at U_N	Power consumption P at U_N
		U_{min}	U_{max}		
V		V	V	mA	VA/W
12	0.012	9.6	13.2	16	0.2/0.2
24	0.024	19.2	26.4	12	0.3/0.2
48	0.048	38.4	52.8	6.9	0.3/0.3
60	0.060	48	66	7	0.5/0.5
110...125	0.125	88	138	5(*)	0.6/0.6(*)
220...240	0.240	176	264	4(*)	1/0.9(*)

(*) Rated coil consumption and power consumption values relate to $U_N = 125$ and 240 V.

Coil data AC, 1 Pole (indicated for max ambient temperature +70 °C)

Nominal voltage U_N	Coil code	Operating range		Rated coil consumption I at U_N	Power consumption P at U_N
		U_{min}	U_{max}		
V		V	V	mA	VA/W
(230...240) AC	8.240	184	264	3	0.7/0.3

Coil data, leakage current suppression types, 1 Pole

Nominal voltage U_N	Coil code	Operating range		Rated coil consumption I at U_N	Power consumption P at U_N
		U_{min}	U_{max}		
V		V	V	mA	VA/W
(110...125) AC/DC	3.125	94	138	8(*)	1/1(*)
(230...240) AC	3.240	184	264	7(*)	1.7/0.5(*)

(*) Rated coil consumption and power consumption values relate to $U_N = 125$ and 240 V.

The 38 Series interface modules (supply version 3) have built-in leakage current suppression to address industry concerns of the contacts not dropping-out when there is residual current in the circuit; at (110...125)V AC and (230...240)V AC.

This problem can occur, for example, when connecting the interface modules to PLCs with triac outputs or when connecting via relatively long cables.

Coil specifications - 1 Pole 16 A and 2 Pole 8 A Electromechanical Relay

Coil data sensitive DC, 1 Pole 16 A and 2 Pole 8 A

Nominal voltage U_N	Coil code	Operating range		Rated coil consumption I at U_N	Power consumption P at U_N
		U_{min}	U_{max}		
V		V	V	mA	W
12	7.012	9.6	14.4	41	0.5
24	7.024	19.2	28.8	19.5	0.5
60	7.060	48	72	8	0.5

Coil data AC/DC, 1 Pole 16 A and 2 Pole 8 A

Nominal voltage U_N	Coil code	Operating range		Rated coil consumption I at U_N	Power consumption P at U_N
		U_{min}	U_{max}		
V		V	V	mA	W
24	0.024	19.2	26.4	20	0.5/0.5
60	0.060	48	66	7.1	0.5/0.5
110...125	0.125	88	138	4.6	0.6/0.6
220...240	0.240	184	264	3.8	0.9/0.9

Coil data AC, 1 Pole 16 A and 2 Pole 8 A

Nominal voltage U_N	Coil code	Operating range		Rated coil consumption I at U_N	Power consumption P at U_N
		U_{min}	U_{max}		
V		V	V	mA	VA/W
230...240	8.230	184	264	5.3	1.2/0.6

Coil specification - 1 & 2 Pole Electromagnetic Relays

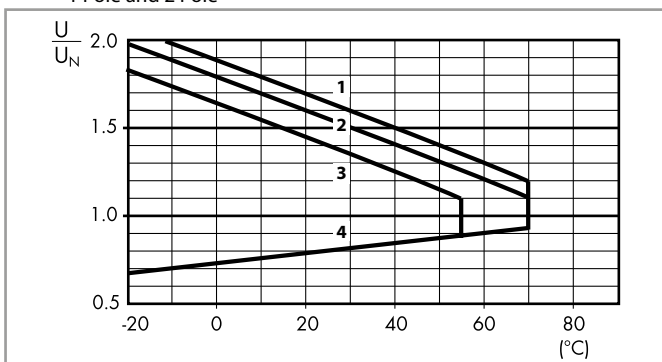

R 38 - DC coil operating range v ambient temperature

1 Pole and 2 Pole



- 1 - Max. permitted coil voltage at nominal load (DC coil).
- 2 - Max. permitted coil voltage at nominal load (AC/DC coils $U \leq 60$ V).
- 3 - Max. permitted coil voltage at nominal load (AC/DC coils $U > 60$ V).
- 4 - Min pick-up voltage with coil at ambient temperature.

Technical data - Solid State Relays

Other data		38.81/38.91		38.31/38.41	
Power lost to the environment	without output current	W	0.25 (24 V DC)	0.5	
	with rated current	W	0.4	2.2 (DC output)/3 (AC output)	
Terminals		38.81		38.91	
Wire strip length	mm	10		10	
 Screw torque	Nm	0.5		—	
Max. wire size		solid cable	stranded cable	solid cable	stranded cable
	mm ²	1 x 2.5 / 2 x 1.5	1 x 2.5 / 2 x 1.5	1 x 2.5	1 x 2.5
	AWG	1 x 14 / 2 x 16	1 x 14 / 2 x 16	1 x 14	1 x 14
		38.31		38.41	
Wire strip length	mm	10		10	
 Screw torque	Nm	0.5		—	
Max. wire size		solid cable	stranded cable	solid cable	stranded cable
	mm ²	1 x 2.5 / 2 x 1.5	1 x 2.5 / 2 x 1.5	1 x 2.5	1 x 2.5
	AWG	1 x 14 / 2 x 16	1 x 14 / 2 x 16	1 x 14	1 x 14

Input specifications - Solid State Relays type 38.81 and 38.91 - 6.2 mm wide

Input data DC

Nominal voltage U _N	Supply code	Operating range		Release voltage U	Rated coil consumption I at U _N	Power consumption P
		U _{min}	U _{max}			
V		V	V	V	mA	W
6	7.006	5	7.2	2.4	7	0.2
24	7.024	16.8	30	10	10.5	0.3
60	7.060	35.6	72	20	6.5	0.4

Input data AC/DC

Nominal voltage U _N	Supply code	Operating range		Release voltage U	Rated coil consumption I at U _N	Power consumption P
		U _{min}	U _{max}			
V		V	V	V	mA	VA/W
110...125	0.125	88	138	22	5.5*	0.7/0.7
220...240	0.240	184	264	44	3.5*	1/0.9

(*) Rated coil consumption and power consumption values relate to U_N = 125 and 240 V.

Input data - Leakage current suppression types

Nominal voltage U _N	Supply code	Operating range		Release voltage U	Rated coil consumption I at U _N	Power consumption P at U _N
		U _{min}	U _{max}			
V		V	V	V	mA	W
110...125 AC/DC	3.125	94	138	44	8(*)	1/1(*)
230...240 AC	3.240	184	264	72	6.5(*)	1.6/0.6(*)

(*) Rated coil consumption and power consumption values relate to U_N = 125 and 240 V.

The 38 Series interface modules (supply version 3) have built-in leakage current suppression to address industry concerns of the contacts not dropping-out when there is residual current in the circuit; at (110...125)V AC and (230...240)V AC.

This problem can occur, for example, when connecting the interface modules to PLCs with triac outputs or when connecting via relatively long cables.

Input specification - Solid State Relay types 38.31 and 38.41 - 14 mm wide

Input data DC

Nominal voltage U _N	Supply code	Operating range		Release voltage U	Rated coil consumption I at U _N	Power consumption P
		U _{min}	U _{max}			
V		V	V	V	mA	W
12	7.012	9.6	18	5	9	0.2
24	7.024	16.8	30	5	12	0.3

Input data AC/DC

Nominal voltage U _N	Supply code	Operating range		Release voltage U	Rated coil consumption I at U _N	Power consumption P
		U _{min}	U _{max}			
V		V	V	V	mA	W
24	0.024	16.8	30	9	16.5	0.3

Output specification - Solid State Relays

L 34-1 - Output DC current v ambient temperature

38.x1.x.xxx.9024 (only 38.81/91/21)

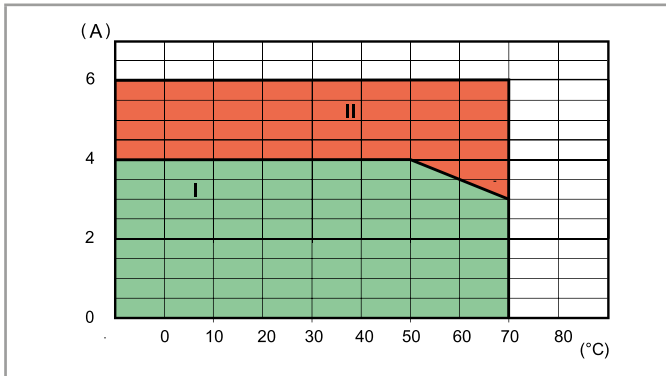

L 34 - Output AC current v ambient temperature

38.x1.x.xxx.8240 (only 38.81/91/21)

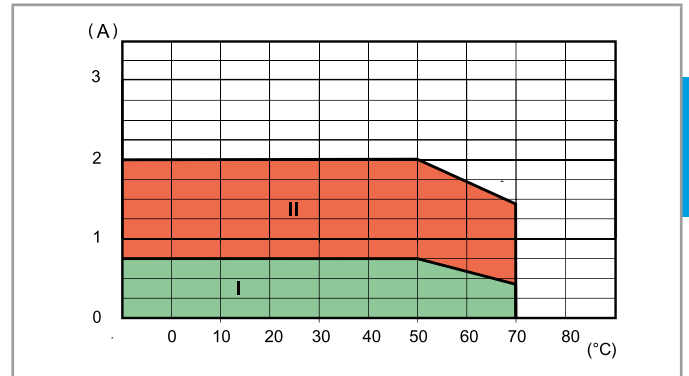

I: SSR installed as a group (without gap between sockets)

II: SSR installed individually in free air, or with a gap ≥ 9 mm, which implies a not significant influence from nearby components

Max recommended switching frequency (Cycles/Hour, with 50% Duty-cycle) at ambient temperature 50°C, single mounting (only 38.81/91/21)

Load	38.x1.x.xxx. 9024	38.x1.x.xxx. 8240	38.x1.x.xxx. 7048
24 V 6 A DC1	180 000	—	—
24 V 3 A DC L/R = 10 ms	5000	—	—
24 V 2 A DC L/R = 40 ms	3600	—	—
24 V 1 A DC L/R = 40 ms	6500	—	—
24 V 0.8 A DC L/R = 40 ms	9000	—	—
24 V 1.5 A DC L/R = 80 ms	3250	—	—
230 V 2 A AC1	—	60 000	—
230 V 1.25 A AC15	—	3600	—
48 V 0.1 A DC1	—	—	60 000

Additional technical data - Timed Interface Module

EMC specifications

Type of test		Reference standard	
Electrostatic discharge	contact discharge	EN 61000-4-2	4 kV
	air discharge	EN 61000-4-2	8 kV
Radio-frequency electromagnetic field (80 ÷ 1000 MHz)		EN 61000-4-3	10 V/m
Fast transients (burst) (5-50 ns, 5 kHz) on Supply terminals		EN 61000-4-4	4 kV
Surges (1.2/50 µs) on Supply terminals	common mode	EN 61000-4-5	4 kV
	differential mode	EN 61000-4-5	4 kV
Radio-frequency common mode (0.15 ÷ 80 MHz) on Supply terminals		EN 61000-4-6	10 V
Radiated and conducted emission		EN 55022	class B

Other data

		EMR	SSR
Power lost to the environment	without contact current	W 0.1	0.1
	with rated current	W 0.6	0.5

Terminals

		38.21	
Wire strip length	mm	10	
Screw torque	Nm	0.5	
Max. wire size		solid cable	stranded cable
	mm ²	1 x 2.5 / 2 x 1.5	1 x 2.5 / 2 x 1.5
	AWG	1 x 14 / 2 x 16	1 x 14 / 2 x 16

Times scales

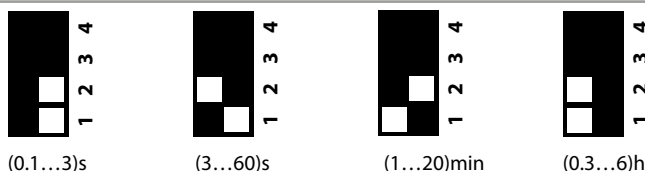

Functions

LED	Supply voltage	NO contact/output
	OFF	Open
	ON	Open (time in progress)
	ON	Closed

Wiring diagram

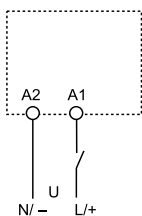

U = Supply voltage

= Output contact

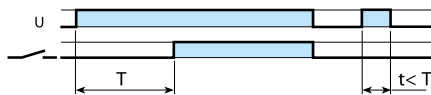

(AI) On-delay.

Apply power to timer. Output contacts transfer after preset time has elapsed. Reset occurs when power is removed.

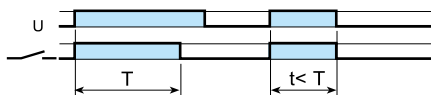
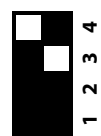

(DI) Interval.

Apply power to timer. Output contacts transfer immediately. After the preset time has elapsed, contacts reset.

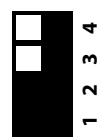

(GI) Pulse delayed.

Apply power to timer. Output contacts transfer after preset time has elapsed. Reset occurs after a fixed time of 0.5 s.

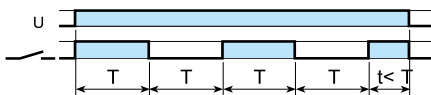
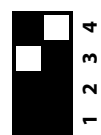

(SW) Symmetrical flasher (starting pulse on).

Apply power to timer. Output contacts transfer immediately and cycle between ON and OFF for as long as power is applied. The ratio is 1:1 (time on = time off).

Outline drawings

38.21
38.51 / 38.51.3
38.81 / 38.81.3
Screw terminal

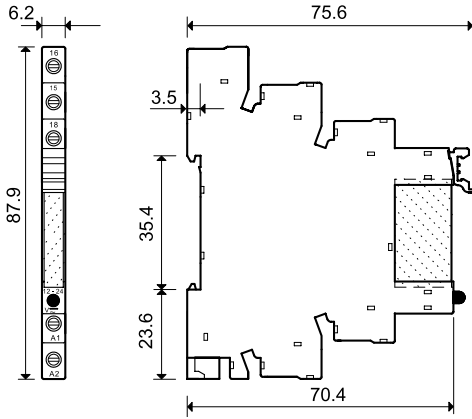

38.01
38.31
38.52
Screw terminal

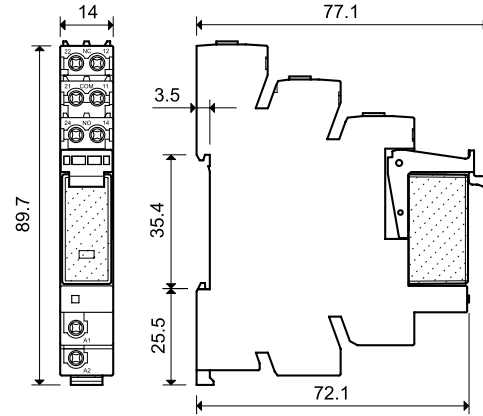

38.61 / 38.61.3
38.91 / 38.91.3
Screwless terminal

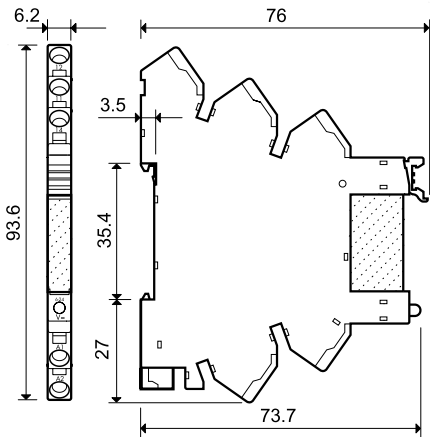

38.11
38.41
38.62
Screwless terminal

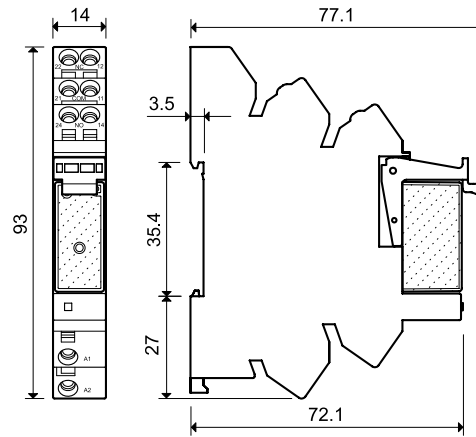

Electromechanical Relay & Socket Combinations

Screw terminal - 1 Pole relay 6 A

Interface Module Code	Coil voltage	Relay	Socket
38.51.0.012.0060	12 V AC/DC	34.51.7.012.0010	93.01.0.024
38.51.0.024.0060	24 V AC/DC	34.51.7.024.0010	93.01.0.024
38.51.0.048.0060	48 V AC/DC	34.51.7.048.0010	93.01.0.060
38.51.0.060.0060	60 V AC/DC	34.51.7.060.0010	93.01.0.060
38.51.0.125.0060	(110...125)V AC/DC	34.51.7.060.0010	93.01.0.125
38.51.0.240.0060	(220...240)V AC/DC	34.51.7.060.0010	93.01.0.240
38.51.3.125.0060	(110...125)V AC/DC	34.51.7.060.0010	93.01.3.125
38.51.3.240.0060	(230...240)V AC	34.51.7.060.0010	93.01.3.240
38.51.7.006.0050	6 V DC	34.51.7.005.0010	93.01.7.024
38.51.7.012.0050	12 V DC	34.51.7.012.0010	93.01.7.024
38.51.7.024.0050	24 V DC	34.51.7.024.0010	93.01.7.024
38.51.7.048.0050	48 V DC	34.51.7.048.0010	93.01.7.060
38.51.7.060.0050	60 V DC	34.51.7.060.0010	93.01.7.060
38.51.8.240.0060	(230...240)V AC	34.51.7.060.0010	93.01.8.240

Screwless terminal - 1 Pole relay 6 A

Interface Module Code	Coil voltage	Relay	Socket
38.61.0.012.0060	12 V AC/DC	34.51.7.012.0010	93.51.0.024
38.61.0.024.0060	24 V AC/DC	34.51.7.024.0010	93.51.0.024
38.61.0.125.0060	(110...125)V AC/DC	34.51.7.060.0010	93.51.0.125
38.61.0.240.0060	(220...240)V AC/DC	34.51.7.060.0010	93.51.0.240
38.61.3.125.0060	(110...125)V AC/DC	34.51.7.060.0010	93.51.3.125
38.61.3.240.0060	(230...240)V AC	34.51.7.060.0010	93.51.3.240
38.61.7.012.0050	12 V DC	34.51.7.012.0010	93.51.7.024
38.61.7.024.0050	24 V DC	34.51.7.024.0010	93.51.7.024
38.61.8.240.0060	(230...240)V AC	34.51.7.060.0010	93.51.8.240

Screw terminal - 1 Pole relay 16 A

Interface Module Code	Coil voltage	Relay	Socket
38.01.7.012.0050	12 V DC	41.61.9.012.0010	93.02.7.024
38.01.7.024.0050	24 V DC	41.61.9.024.0010	93.02.7.024
38.01.7.060.0050	60 V DC	41.61.9.060.0010	93.02.7.060
38.01.0.024.0060	24 V AC/DC	41.61.9.024.0010	93.02.0.024
38.01.0.060.0060	60 V AC/DC	41.61.9.060.0010	93.02.0.060
38.01.0.125.0060	125 V AC/DC	41.61.9.110.0010	93.02.0.125
38.01.0.240.0060	240 V AC/DC	41.61.9.110.0010	93.02.0.240
38.01.8.230.0060	230 V AC	41.61.9.110.0010	93.02.8.230

Screwless terminal - 1 Pole relay 16 A

Interface Module Code	Coil voltage	Relay	Socket
38.11.7.012.0050	12 V DC	41.61.9.012.0010	93.52.7.024
38.11.7.024.0050	24 V DC	41.61.9.024.0010	93.52.7.024
38.11.7.060.0050	60 V DC	41.61.9.060.0010	93.52.7.060
38.11.0.024.0060	24 V AC/DC	41.61.9.024.0010	93.52.0.024
38.11.0.060.0060	60 V AC/DC	41.61.9.060.0010	93.52.0.060
38.11.0.125.0060	125 V AC/DC	41.61.9.110.0010	93.52.0.125
38.11.0.240.0060	240 V AC/DC	41.61.9.110.0010	93.52.0.240
38.11.8.230.0060	230 V AC	41.61.9.110.0010	93.52.8.230

Screw terminal - 2 Pole relay 8 A

Interface Module Code	Coil voltage	Relay	Socket
38.52.0.024.0060	24 V AC/DC	41.52.9.024.0010	93.02.0.024
38.52.0.060.0060	60 V AC/DC	41.52.9.060.0010	93.02.0.060
38.52.0.125.0060	(110...125)V AC/DC	41.52.9.110.0010	93.02.0.125
38.52.0.240.0060	(220...240)V AC/DC	41.52.9.110.0010	93.02.0.240
38.52.7.012.0050	12 V DC	41.52.9.012.0010	93.02.7.024
38.52.7.024.0050	24 V DC	41.52.9.024.0010	93.02.7.024
38.52.7.060.0050	60 V DC	41.52.9.060.0010	93.02.7.060
38.52.8.230.0060	(230...240)V AC	41.52.9.110.0010	93.02.8.230

Screwless terminal - 2 Pole relay 8 A

Interface Module Code	Coil voltage	Relay	Socket
38.62.0.024.0060	24 V AC/DC	41.52.9.024.0010	93.52.0.024
38.62.0.060.0060	60 V AC/DC	41.52.9.060.0010	93.52.0.060
38.62.0.125.0060	(110...125)V AC/DC	41.52.9.110.0010	93.52.0.125
38.62.0.240.0060	(220...240)V AC/DC	41.52.9.110.0010	93.52.0.240
38.62.7.012.0050	12 V DC	41.52.9.012.0010	93.52.7.024
38.62.7.024.0050	24 V DC	41.52.9.024.0010	93.52.7.024
38.62.7.060.0050	60 V DC	41.52.9.060.0010	93.52.7.060
38.62.8.230.0060	(230...240)V AC	41.52.9.110.0010	93.52.8.230

B

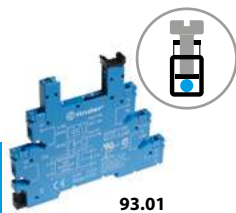

93.01

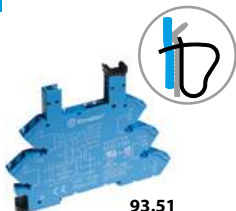

93.51



93.02

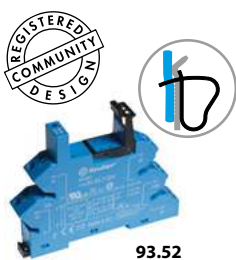

93.52

Approvals
(according to type):



 Certain relay/socket combinations

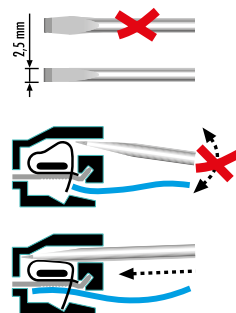

Solid State Relay & Socket Combinations - 6.2 mm wide



93.01

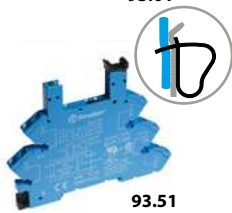

93.51

Approvals
(according to type):



Certain relay/socket combinations

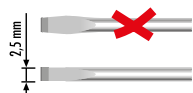

Screw terminal

Interface Module Code	Input voltage	Relay	Socket
38.81.7.006.xxxx	6 V DC	34.81.7.005.xxxx	93.01.7.024
38.81.7.024.xxxx	24 V DC	34.81.7.024.xxxx	93.01.7.024
38.81.7.060.xxxx	60 V DC	34.81.7.060.xxxx	93.01.7.060
38.81.0.125.xxxx	(110...125)V AC/DC	34.81.7.060.xxxx	93.01.0.125
38.81.0.240.xxxx	(220...240)V AC/DC	34.81.7.060.xxxx	93.01.0.240
38.81.3.125.xxxx	(110...125)V AC/DC	34.81.7.060.xxxx	93.01.3.125
38.81.3.240.xxxx	(230...240)V AC	34.81.7.060.xxxx	93.01.3.240

Screwless terminal

Interface Module Code	Input voltage	Relay	Socket
38.91.7.006.xxxx	6 V DC	34.81.7.005.xxxx	93.51.7.024
38.91.7.024.xxxx	24 V DC	34.81.7.024.xxxx	93.51.7.024
38.91.7.060.xxxx	60 V DC	34.81.7.060.xxxx	93.51.7.060
38.91.0.125.xxxx	(110...125)V AC/DC	34.81.7.060.xxxx	93.51.0.125
38.91.0.240.xxxx	(220...240)V AC/DC	34.81.7.060.xxxx	93.51.0.240
38.91.3.125.xxxx	(110...125)V AC/DC	34.81.7.060.xxxx	93.51.3.125
38.91.3.240.xxxx	(230...240)V AC	34.81.7.060.xxxx	93.51.3.240

Example: .xxxx
.9024
.7048
.8240

Solid State Relay & Socket Combinations - 14 mm wide

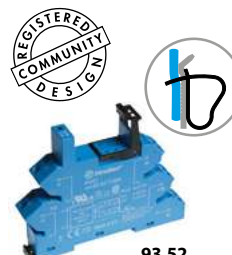

93.52

Approvals
(according to type):



Screw terminal

Interface Module Code	Input voltage	Relay	Socket
38.31.0.024.xxxx	24 V AC/DC	41.81.7.024.xxxx	93.02.0.024
38.31.7.012.xxxx	12 V DC	41.81.7.012.xxxx	93.02.7.024
38.31.7.024.xxxx	24 V DC	41.81.7.024.xxxx	93.02.7.024

Screwless terminal

Interface Module Code	Input voltage	Relay	Socket
38.41.0.024.xxxx	24 V AC/DC	41.81.7.024.xxxx	93.52.0.024
38.41.7.012.xxxx	12 V DC	41.81.7.012.xxxx	93.52.7.024
38.41.7.024.xxxx	24 V DC	41.81.7.024.xxxx	93.52.7.024

SSR / EMR & Timer Socket Combinations

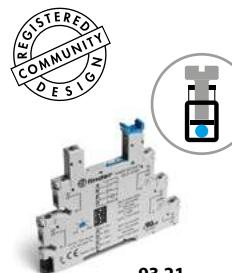

93.21

Approvals
(according to type):



Screw terminal

Interface Module Code	Input / Coil voltage	Relay	Socket
38.21.0.012.0060	12 V AC/DC	34.51.7.012.0010	93.21.0.024
38.21.0.024.0060	24 V AC/DC	34.51.7.024.0010	93.21.0.024
38.21.0.024.xxxx	24 V AC/DC	34.81.7.024.xxxx	93.21.0.024

Accessories



093.20

B

Approvals
(according to type):



20-way jumper link for 38.21/51/61/81/91	093.20 (blue)	093.20.0 (black)	093.20.1 (red)
Rated values	36 A - 250 V		

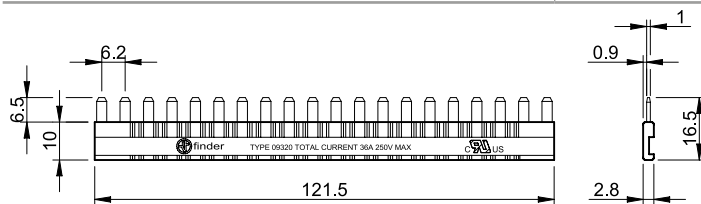

093.08

Approvals
(according to type):



8-way jumper link for 38.01/11/31/41/52/62	093.08 (blue)	093.08.0 (black)	093.08.1 (red)
Rated values	10 A - 250 V		

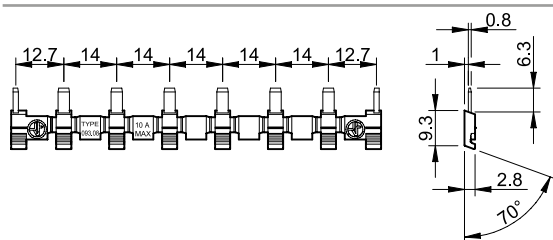

093.01

Plastic separator	093.01
--------------------------	--------

Thickness 2 mm, required at the start and the end of a group of interfaces.

Can be used for visual separation group, must be used for:

- protective separation of different voltages of neighbouring PLC interfaces according to VDE 0106-101
- protection of cut jumper links

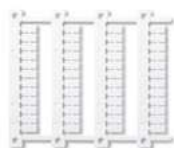

NEW

093.48

Sheet of marker tags for 38.21/51/61/81/91, plastic, 48 tags, 6 x 10 mm	093.48
--	--------

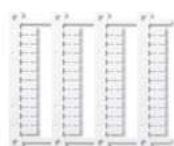

060.48

Sheet of marker tags (CEMBRE Thermal transfer printers) for 38.01/11/31/41/52/62 types (48 tags), 6 x 12 mm	060.48
--	--------



finder[®]
SWITCH TO THE FUTURE

39
SERIES

MasterINTERFACE - Relay interface modules 0.1 - 2 - 6 A



Packaging machines



Bottling plant



Traffic light controls



Carousel warehouses



Control panels



Panels for electrical distribution



Labelling machines



Hoists and cranes

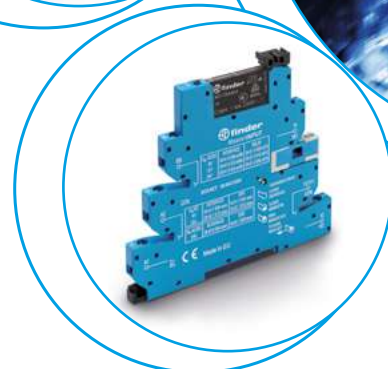
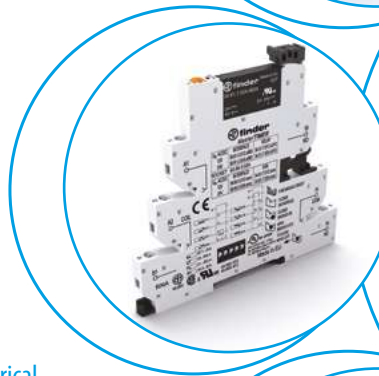
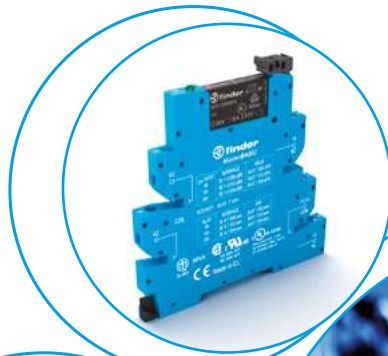

Common features

- Space saving 6.2 mm wide
- Connections for 16-way jumper link
- Integral coil indication and protection circuit
- Secure retention and easy ejection by plastic clip
- Dual screw head (blade+cross) terminals and Push-in terminals versions
- 35 mm rail mounting (EN 60715)

MasterBASIC

- For general use in any type of system
- **EMR: 6 to 24 and 125 V AC/DC, 230 V AC supply**
- **SSR: 6 to 24 V DC, 125 V AC/DC, 230 V AC supply**
- Screw terminal and Push-in terminal

MasterBASIC - EMR ATEX

- Available on request - See page 16

MasterPLUS

- Accepts the output fuse module, for the easy and space efficient protection of output circuits
- **EMR: 6 to 125 V AC/DC, 125 and 220 V DC, 230 V AC and 24...240 V AC/DC supply**
- **SSR: 24 - 125 V AC/DC, 6 to 220 V DC, 230 V AC and 24...240 V AC/DC supply**
- **Special 125 V AC/DC and 230 V AC leakage current suppression types (39.31.3, 39.61.3 EMR and 39.30.3, 39.60.3 SSR)**
- Screw terminal and Push-in terminal

MasterINPUT

- Jumper link option for the quick and easy distribution of supply voltage to proximity switches and similar input devices
- **EMR: 6 to 24 V and 125 V AC/DC, 230 V AC supply**
- **SSR: 6 - 24 V DC, 24 - 125 V AC/DC, 230 V AC supply**
- Screw terminal and Push-in terminal

MasterOUTPUT

- Jumper link option for the quick and easy distribution of supply voltage to output side and its connection to electromagnetic valves and similar output devices
- **EMR: 6 to 24 V and 125 V AC/DC, 230 V AC supply**
- **SSR: 6 to 24 V DC, 125 V AC/DC, 230 V AC supply**
- Screw terminal and Push-in terminal

MasterTIMER

- Timer adjustment via top mounted rotary knob accessible after assembly
- Control signal terminal
- DIP-switch for selection of 4 time scales and 8 functions
- Output with fuse module option
- **EMR and SSR: 12 to 24 V AC/DC supply**
- Screw terminal and Push-in terminal

**EMR
Electromechanical Relays**

- **1 CO 6 A/250 V AC**
- High switching capability

**SSR
Solid State Relays**

- 1 solid state output (options **0.1 A/48 V DC, 6 A/24 V DC, 2 A/240 V AC**)
- Silent, high speed switching, long electrical life

39.11/39.01



Page 6

39.10/39.00



Page 7

39.31 - 39.31.3/39.61 - 39.61.3



Page 8

39.30 - 39.30.3/39.60 - 39.60.3



Page 9

39.41/39.71



Page 10

39.40/39.70



Page 11

39.21/39.51



Page 12

39.20/39.50



Page 13

39.81/39.91



Page 14

39.80/39.90



Page 15

MasterBASIC

39.11 - 39.10 - 39.01 - 39.00

- For general interface use in any type of system and application.
- Can be used for input interface applications between auxiliary contacts, sensors etc. and controllers, PLC's or motors. Or for output interface between PLC's controllers and relays, solenoids etc.

MasterPLUS

39.31 - 39.30 - 39.31.3 - 39.30.3 - 39.61 - 39.60 - 39.61.3 - 39.60.3

- This special version provides extra protection for the output circuit thanks to the replaceable fuse module.
- For general interface use in any type of system and application.
- Can be used for input interface applications between auxiliary contacts, sensors etc. and controllers, PLC's or motors. Or for output interface between PLC's controllers and relays, solenoids etc.

B

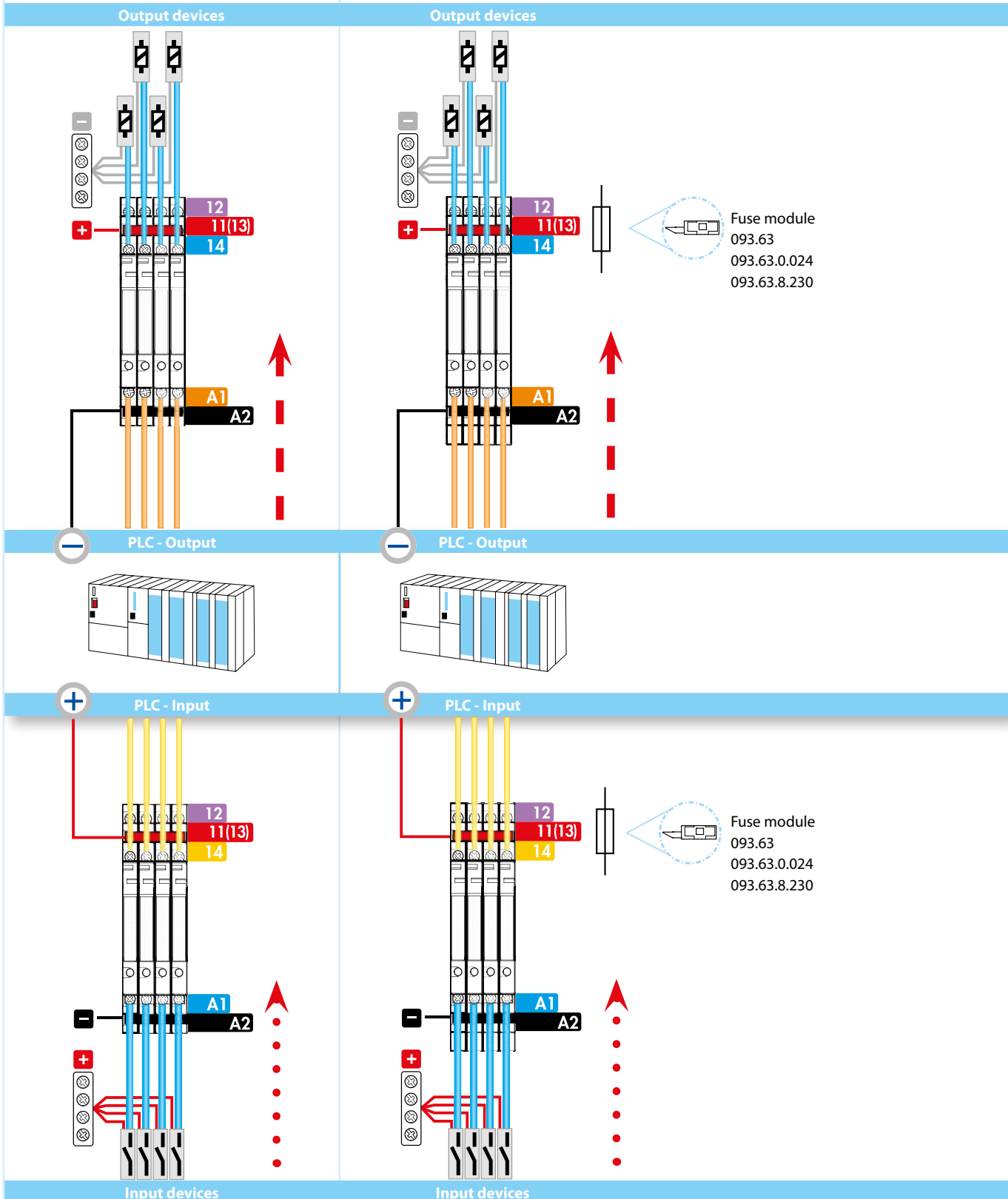

MasterINPUT

39.41 - 39.40 - 39.71 - 39.70

- These models allow the full termination of input device to the interface without the need for additional terminals - saving component cost, time and panel space.
- Quick and easy distribution of supply voltage through the jumper link on the Bus-Bar (BB) connection.
- Ideal for interface applications between the auxiliary contacts, sensors, limit switches and Controllers or PLC's.

MasterOUTPUT

39.21 - 39.20 - 39.51 - 39.50

- These models allow the full termination of output device to the interface without the need for additional terminals - saving component cost, time and panel space.
- Quick and easy distribution of supply voltage through the jumper link on the Bus-Bar (BB) connection.
- Ideal for interface applications between the PLC's or Controllers and output devices such as electromagnetic valves or motors etc..

MasterTIMER

39.81 - 39.80 - 39.91 - 39.90

- Slim and Multifunction Timed Interface modules.

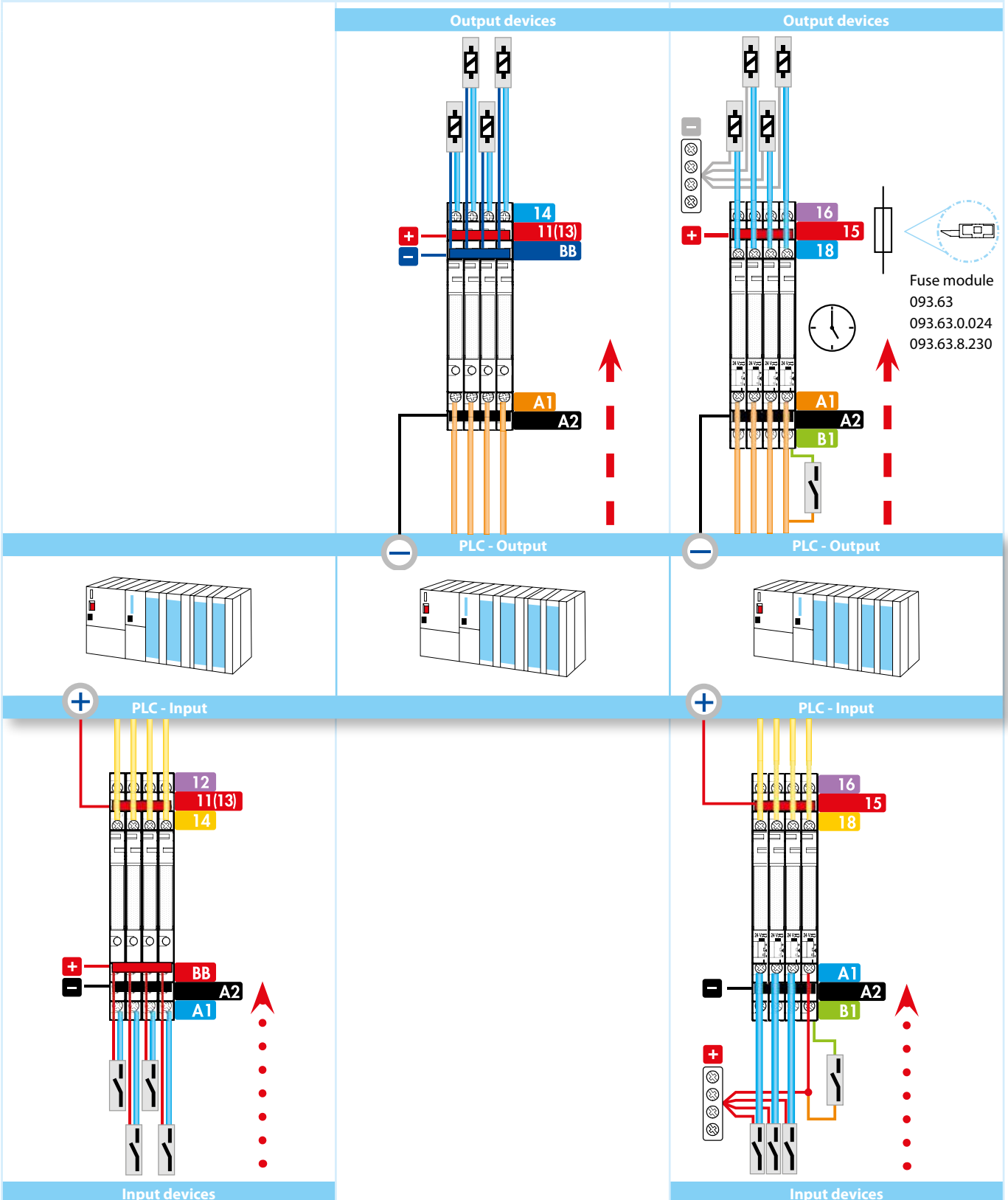

MasterBASIC - EMR

1 Pole interface module, 6.2 mm wide, ideal for PLC and electronic systems

- Common connection possible with optional jumper links (terminals A1, A2 and 11)
- UL Listing (certain relay/socket combinations)

B



- 6 A electromechanical relay
- 6 to 24 and 125 V AC/DC and 230 V AC supply
- Screw terminal and push-in terminal
- 35 mm rail (EN 60715) mounting

39.11
Screw terminal



39.01
Push-in terminal

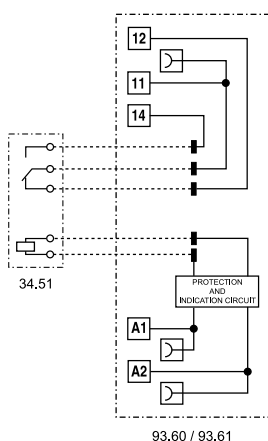

For outline drawing see page 25, 26

Contact specification

Contact configuration		1 CO (SPDT)
Rated current/ Maximum peak current	A	6/10
Rated voltage/ Maximum switching voltage	V AC	250/400
Rated load AC1	VA	1500
Rated load AC15 (230 V AC)	VA	300
Single phase motor rating (230 V AC)	kW	0.185
Breaking capacity DC1: 30/110/220 V	A	6/0.2/0.12
Minimum switching load	mW (V/mA)	500 (12/10)
Standard contact material		AgNi

Supply specification

Nominal voltage (U_N)	V AC/DC	6 - 12 - 24 - 110...125
	V AC (50/60 Hz)	220...240
Rated power	VA (50 Hz)/W	See page 20
Operating range		$(0.8...1.1)U_N$
Holding voltage		$0.6 U_N$
Must drop-out voltage		$0.1 U_N$

Technical data

Mechanical life AC/DC	cycles	$10 \cdot 10^6$
Electrical life at rated load AC1	cycles	$60 \cdot 10^3$
Operate/release time	ms	5/6
Insulation between coil and contacts (1.2/50 μ s)	kV	6 (8 mm)
Dielectric strength between open contacts	V AC	1000
Ambient temperature range	$^{\circ}$ C	-40...+70
Protection category		IP 20

Approvals relay (according to type)



MasterBASIC - SSR

1 Pole interface module, 6.2 mm wide, ideal for PLC and electronic systems

- Common connection possible with optional jumper links (terminals A1, A2 and 13+)
- UL Listing (certain relay/socket combinations)



- 0.1, 2 or 6 A solid state relay
- 6 to 24 and 125 V AC/DC and 230 V AC supply
- Screw terminal and push-in terminal
- 35 mm rail (EN 60715) mounting

39.10
Screw terminal



39.00
Push-in terminal

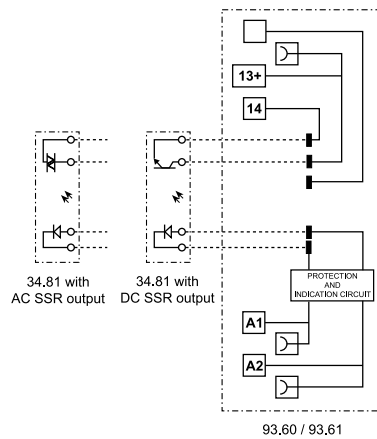

For outline drawing see page 25, 26

Output specification (SSR)		39.x0.x.xxx.9024	39.x0.x.xxx.7048	39.x0.x.xxx.8240
Contact configuration		1 NO (SPST-NO)		
Rated current/ Maximum peak current (10 ms)	A	6/50	0.1/0.5	2/80
Rated voltage/ Maximum blocking voltage	V	24/33 DC	48/53 DC	240/— AC
Switching voltage range	V	(1.5...33) DC	(1.5...53) DC	(12...275) AC
Repetitive peak off-state voltage	V _{pk}	—	—	800
Minimum switching current	mA	1	0.05	35
Max. "OFF-state" leakage current	mA	0.001	0.001	1.5
Max. "ON-state" voltage drop	V	0.4	1	1.6
Supply specification				
Nominal voltage (U _N)	V AC/DC	110...125		
	V AC (50/60 Hz)	220...240		
	V DC	6 - 12 - 24		
Rated power	VA (50 Hz)/W	See page 21		
Operating range		(0.8...1.1)U _N		
Must drop-out voltage		0.1 U _N		
Technical data				
Operate/release time	ms	0.2/0.6	0.04/0.6	12/12
Dielectric strength between input/output	V AC	3000		
Ambient temperature range	°C	-20...+55		
Protection category		IP 20		
Approvals relay (according to type)				



MasterPLUS - EMR

1 Pole interface modules, 6.2 mm wide, ideal for PLC and electronic systems

- Accepts output fuse module **093.63**, **093.63.0.024**, **093.63.8.230** (for 5 x 20 mm fuses) for quick and easy load protection, see page 30
- Common connection possible with optional jumper links (terminals A1, A2 and 11)
- UL Listing (certain relay/socket combinations)

B



- 6 A electromechanical relay
- 6 to 125 V AC/DC, 125 and 220 V DC, 230 V AC, 24...240 V AC/DC supply
- Screw terminal and push-in terminal
- 35 mm rail (EN 60715) mounting



- 6 A electromechanical relay
- Leakage current suppression version, 125 V AC/DC and 230 V AC supply
- Screw terminal and push-in terminal

39.31/39.31.3
Screw terminal



39.61/39.61.3
Push-in terminal

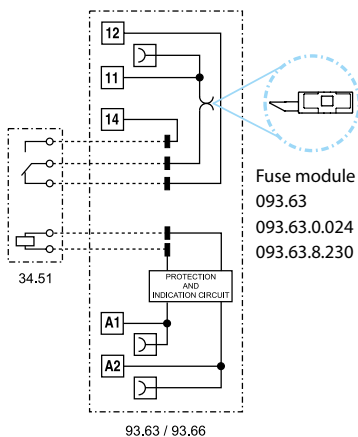

For outline drawing see page 25, 26

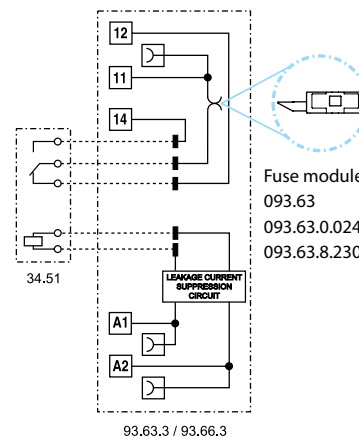

Contact specification

Contact configuration		1 CO (SPDT)	1 CO (SPDT)
Rated current/ Maximum peak current	A	6/10	6/10
Rated voltage/ Maximum switching voltage	V AC	250/400	250/400
Rated load AC1	VA	1500	1500
Rated load AC15 (230 V AC)	VA	300	300
Single phase motor rating (230 V AC)	kW	0.185	0.185
Breaking capacity DC1: 30/110/220 V	A	6/0.2/0.12	6/0.2/0.12
Minimum switching load	mW (V/mA)	500 (12/10)	500 (12/10)
Standard contact material		AgNi	AgNi

Supply specification

Nominal voltage (U _N)	V AC/DC	6 - 12 - 24 - 60 - 110...125 - 24...240	110...125
	V AC (50/60 Hz)	220...240	220...240
	V DC	110...125 - 220	—
Rated power	VA (50 Hz)/W	See page 20	See page 20
Operating range		(0.8...1.1)U _N	(0.8...1.1)U _N
Holding voltage		0.6 U _N	0.6 U _N
Must drop-out voltage		0.1 U _N	0.3 U _N

Technical data

Mechanical life AC/DC	cycles	10 · 10 ⁶	10 · 10 ⁶
Electrical life at rated load AC1	cycles	60 · 10 ³	60 · 10 ³
Operate/release time	ms	5/6	5/6
Insulation between coil and contacts (1.2/50 μs)	kV	6 (8 mm)	6 (8 mm)
Dielectric strength between open contacts	V AC	1000	1000
Ambient temperature range	°C	-40...+70 (+55 for 220 V DC)	-40...+70
Protection category		IP 20	IP 20

Approvals relay (according to type)



MasterPLUS - SSR

1 Pole interface modules, 6.2 mm wide, ideal for PLC and electronic systems

- Accepts output fuse module **093.63**, **093.63.0.024**, **093.63.8.230** (for 5 x 20 mm fuses) for quick and easy load protection, see page 30
- Common connection possible with optional jumper links (terminals A1, A2 and 13+)
- UL Listing (certain relay/socket combinations)



- 0.1, 2 or 6 A solid state relay
- 24 - 125 V AC/DC, 6 to 220 V DC and 230 V AC, 24...240 V AC/DC supply
- Screw terminal and push-in terminal
- 35 mm rail (EN 60715) mounting



- 0.1, 2 or 6 A solid state relay
- Leakage current suppression version, 125 V AC DC and 230 V AC supply
- Screw terminal and push-in terminal

39.30/39.30.3
Screw terminal



39.60/39.60.3
Push-in terminal

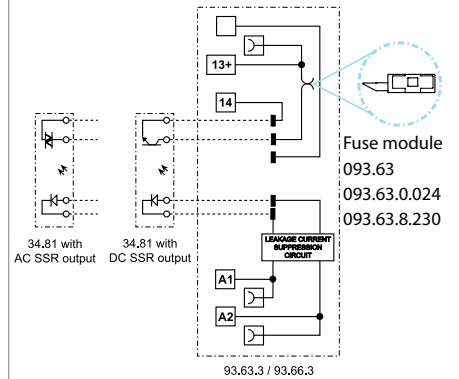
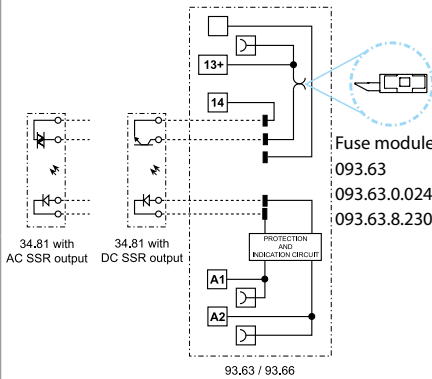

For outline drawing see page 25, 26

Output specification (SSR)		39.x0.x.xxx.9024	39.x0.x.xxx.7048	39.x0.x.xxx.8240	39.x0.3.xxx.9024	39.x0.3.xxx.7048	39.x0.3.xxx.8240
Contact configuration		1 NO (SPST-NO)			1 NO (SPST-NO)		
Rated current/ Maximum peak current (10 ms)	A	6/50	0.1/0.5	2/80	6/50	0.1/0.5	2/80
Rated voltage/ Maximum blocking voltage	V	24/33 DC	48/53 DC	240/— AC	24/33 DC	48/53 DC	240/— AC
Switching voltage range	V	(1.5...33) DC	(1.5...53)DC	(12...275) AC	(1.5...33) DC	(1.5...53)DC	(12...275) AC
Repetitive peak off-state voltage	V _{pk}	—	—	800	—	—	800
Minimum switching current	mA	1	0.05	35	1	0.05	35
Max. "OFF-state" leakage current	mA	0.001	0.001	1.5	0.001	0.001	1.5
Max. "ON-state" voltage drop	V	0.4	1	1.6	0.4	1	1.6
Supply specification							
Nominal voltage (U _N)	V AC/DC	24 - 110...125 - 24...240			110...125		
	V AC (50/60 Hz)	220...240			220...240		
	V DC	6 - 12 - 24 - 60 - 110...125 - 220			—		
Rated power	VA (50 Hz)/W	See page 21			See page 21		
Operating range		(0.8...1.1)U _N			(0.8...1.1)U _N		
Must drop-out voltage		0.1 U _N			0.3 U _N		
Technical data							
Operate/release time	ms	0.2/0.6	0.04/0.6	12/12	0.2/0.6	0.04/0.6	12/12
Dielectric strength between input/output	V AC	3000			3000		
Ambient temperature range	°C	-20...+55			-20...+55		
Protection category		IP 20			IP 20		
Approvals relay (according to type)							

MasterINPUT - EMR

1 Pole interface module, 6.2 mm wide, ideal for PLC and electronic systems

- Jumper link option for the quick and easy distribution of supply voltage to proximity switches and similar input devices (Bus-bar connection BB)
- Gold plated output contact as standard, for better compatibility with low energy PLC inputs
- UL Listing (certain relay/socket combinations)



- 6 A electromechanical relay
- 6 - 12 - 24 - 125 V AC/DC and 230 V AC supply
- Screw terminal and push-in terminal
- 35 mm rail (EN 60715) mounting

39.41
Screw terminal



39.71
Push-in terminal

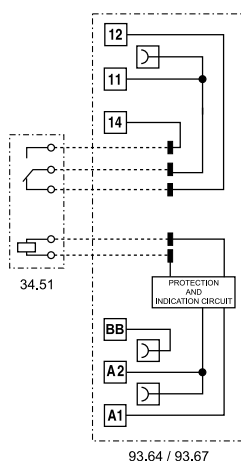

For outline drawing see page 25, 26

Contact specification

Contact configuration		1 CO (SPDT)
Rated current/ Maximum peak current	A	6/10
Rated voltage/ Maximum switching voltage	V AC	250/400
Rated load AC1	VA	1500
Rated load AC15 (230 V AC)	VA	300
Single phase motor rating (230 V AC)	kW	0.185
Breaking capacity DC1: 30/110/220 V	A	6/0.2/0.12
Minimum switching load	mW (V/mA)	50 (5/2)
Standard contact material		AgNi + Au

Supply specification

Nominal voltage (U_N)	V AC/DC	6 - 12 - 24 - 110...125
	V AC (50/60 Hz)	220...240
Rated power	VA (50 Hz)/W	See page 20
Operating range		$(0.8...1.1)U_N$
Holding voltage		$0.6 U_N$
Must drop-out voltage		$0.1 U_N$

Technical data

Mechanical life AC/DC	cycles	$10 \cdot 10^6$
Electrical life at rated load AC1	cycles	$60 \cdot 10^3$
Operate/release time	ms	5/6
Insulation between coil and contacts (1.2/50 μ s)	kV	6 (8 mm)
Dielectric strength between open contacts	V AC	1000
Ambient temperature range	$^{\circ}$ C	-40...+70
Protection category		IP 20

Approvals relay (according to type)



MasterINPUT - SSR

1 Pole interface modules, 6.2 mm wide, ideal for PLC and electronic systems

- Jumper link option for the quick and easy distribution of supply voltage to proximity switches and similar input devices (Bus-bar connection BB)
- UL Listing (certain relay/socket combinations)



- 0.1, 2 or 6 A solid state relay
- 6 - 12 - 24 V DC, 24 - 125 V AC/DC and 230 V AC supply
- Screw terminal and push-in terminal
- 35 mm rail (EN 60715) mounting

39.40
Screw terminal



39.70
Push-in terminal

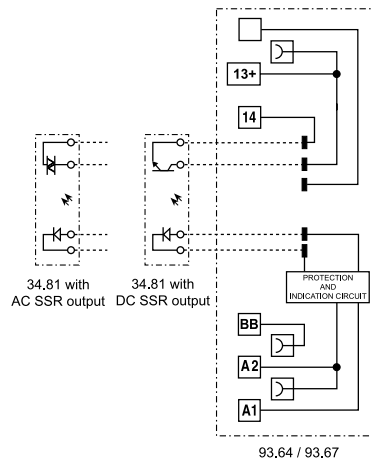

For outline drawing see page 25, 26

Output specification (SSR)		39.x0.x.xxx.9024	39.x0.x.xxx.7048	39.x0.x.xxx.8240
Contact configuration		1 NO (SPST-NO)		
Rated current/ Maximum peak current (10 ms)	A	6/50	0.1/0.5	2/80
Rated voltage/ Maximum blocking voltage	V	24/33 DC	48/53 DC	240/— AC
Switching voltage range	V	(1.5...33) DC	(1.5...53) DC	(12...275) AC
Repetitive peak off-state voltage	V _{pk}	—	—	800
Minimum switching current	mA	1	0.05	35
Max. "OFF-state" leakage current	mA	0.001	0.001	1.5
Max. "ON-state" voltage drop	V	0.4	1	1.6
Supply specification				
Nominal voltage (U _N)	V AC/DC	24 - 110...125		
	V AC (50/60 Hz)	220...240		
	V DC	6 - 12 - 24		
Rated power	VA (50 Hz)/W	See page 21		
Operating range		(0.8...1.1)U _N		
Must drop-out voltage		0.1 U _N		
Technical data				
Operate/release time	ms	0.2/0.6	0.04/0.6	12/12
Dielectric strength between input/output	V AC	3000		
Ambient temperature range	°C	-20...+55		
Protection category		IP 20		
Approvals relay (according to type)				

MasterOUTPUT - EMR

1 Pole interface modules, 6.2 mm wide, ideal for PLC and electronic systems

- Jumper link option for the quick and easy distribution of supply voltage to output side (Bus-bar connection BB) and its connection to electromagnetic valves and similar output devices
- UL Listing (certain relay/socket combinations)

B



- 6 A electromechanical relay
- 6 - 12 - 24 - 125 V AC/DC and 230 V AC supply
- Screw terminal and push-in terminal
- 35 mm rail (EN 60715) mounting

39.21
Screw terminal



39.51
Push-in terminal

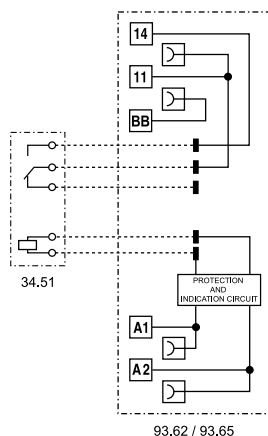

For outline drawing see page 25, 26

Contact specification

Contact configuration		1 NO (SPST-NO)
Rated current/ Maximum peak current	A	6/10
Rated voltage/ Maximum switching voltage	V AC	250/400
Rated load AC1	VA	1500
Rated load AC15 (230 V AC)	VA	300
Single phase motor rating (230 V AC)	kW	0.185
Breaking capacity DC1: 30/110/220 V	A	6/0.2/0.12
Minimum switching load	mW (V/mA)	500 (12/10)
Standard contact material		AgNi

Supply specification

Nominal voltage (U _N)	V AC/DC	6 - 12 - 24 - 110...125
	V AC (50/60 Hz)	220...240
Rated power	VA (50 Hz)/W	See page 20
Operating range		(0.8...1.1)U _N
Holding voltage		0.6 U _N
Must drop-out voltage		0.1 U _N

Technical data

Mechanical life AC/DC	cycles	10 · 10 ⁶
Electrical life at rated load AC1	cycles	60 · 10 ³
Operate/release time	ms	5/6
Insulation between coil and contacts (1.2/50 μs)	kV	6 (8 mm)
Dielectric strength between open contacts	V AC	1000
Ambient temperature range	°C	-40...+70
Protection category		IP 20

Approvals relay (according to type)



MasterOUTPUT - SSR

1 Pole interface modules, 6.2 mm wide, ideal for PLC and electronic systems

- Jumper link option for the quick and easy distribution of supply voltage to output side (Bus-bar connection BB) and its connection to electromagnetic valves and similar output devices
- UL Listing (certain relay/socket combinations)



- 0.1, 2 or 6 A solid state relay
- 6 to 24 V DC, 125 V AC/DC and 230 V AC supply
- Screw terminal and push-in terminal
- 35 mm rail (EN 60715) mounting

39.20
Screw terminal



39.50
Push-in terminal

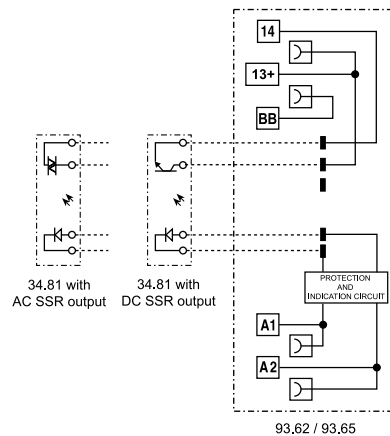

For outline drawing see page 25, 26

Output specification (SSR)		39.x0.x.xxx.9024	39.x0.x.xxx.7048	39.x0.x.xxx.8240
Contact configuration		1 NO (SPST-NO)		
Rated current/ Maximum peak current (10 ms)	A	6/50	0.1/0.5	2/80
Rated voltage/ Maximum blocking voltage	V	24/33 DC	48/53 DC	240/— AC
Switching voltage range	V	(1.5...33) DC	(1.5...53) DC	(12...275) AC
Repetitive peak off-state voltage	V _{pk}	—	—	800
Minimum switching current	mA	1	0.05	35
Max. "OFF-state" leakage current	mA	0.001	0.001	1.5
Max. "ON-state" voltage drop	V	0.4	1	1.6
Supply specification				
Nominal voltage (U _N)	V AC/DC	110...125		
	V AC (50/60 Hz)	220...240		
	V DC	6 - 12 - 24		
Rated power	VA (50 Hz)/W	See page 21		
Operating range		(0.8...1.1)U _N		
Must drop-out voltage		0.1 U _N		
Technical data				
Operate/release time	ms	0.2/0.6	0.04/0.6	12/12
Dielectric strength between input/output	V AC	3000		
Ambient temperature range	°C	-20...+55		
Protection category		IP 20		
Approvals relay (according to type)				

MasterTIMER - EMR

Slim timed interface module, 6.2 mm wide, ideal for space-saving timing solutions in panels

- Timer adjustment via top mounted rotary knob, accessible after assembly
- Control signal terminal
- DIP-switch for selection of 4 time scales and 8 functions
- Accepts output fuse module **093.63**, **093.63.0.024**, **093.63.8.230** (for 5 x 20 mm fuses) for quick and easy load protection, see page 30
- Common connection possible with optional jumper links (terminals A1, A2 and 15)
- UL Listing (certain relay/socket combinations)

B



- 6 A electromechanical relay
- 12 - 24 V AC/DC supply
- Screw terminal and push-in terminal
- 35 mm rail (EN 60715) mounting

39.81
Screw terminal



39.91
Push-in terminal

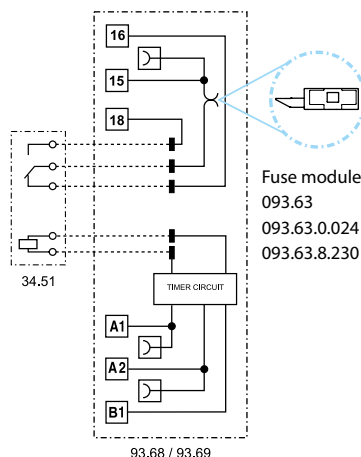

- AI:** On-delay
- DI:** Interval
- GI:** Pulse (0.5 s) delayed
- SW:** Symmetrical flasher (starting pulse on)
- BE:** Off-delay with control signal
- CE:** On- and off-delay with control signal
- DE:** Interval with control signal on
- EE:** Interval with control signal off

For outline drawing see page 25, 26

Contact specification

Contact configuration		1 CO (SPDT)
Rated current/ Maximum peak current	A	6/10
Rated voltage/ Maximum switching voltage	V AC	250/400
Rated load AC1	VA	1500
Rated load AC15 (230 V AC)	VA	300
Single phase motor rating (230 V AC)	kW	0.185
Breaking capacity DC1: 30/110/220 V	A	6/0.2/0.12
Minimum switching load	mW (V/mA)	500 (12/10)
Standard contact material		AgNi

Supply specification

Nominal voltage (U _N)	V AC/DC	12 - 24
Rated power AC/DC	VA (50 Hz)/W	See page 20
Operating range		(0.8...1.1)U _N
Holding voltage		0.6 U _N
Must drop-out voltage		0.1 U _N

Technical data

Specified time range		(0.1...3)s, (3...60)s, (1...20)min, (0.3...6)h
Repeatability	%	± 1
Recovery time	ms	≤ 50
Minimum control impulse	ms	50
Setting accuracy - full range	%	5
Electrical life at rated load AC1	cycles	60 · 10 ³
Ambient temperature range	°C	-20...+50
Protection category		IP 20

Approvals relay (according to type)





MasterTIMER - SSR

Slim timed interface module, 6.2 mm wide, ideal for space-saving timing solutions in panels

- Timer adjustment via top mounted rotary knob; accessible after assembly
- Start terminal
- DIP-switch for selection of 4 time scales and 8 functions
- Accepts output fuse module **093.63**, **093.63.0.024**, **093.63.8.230** (for 5 x 20 mm fuses) for quick and easy load protection, see page 30
- Common connection possible with optional jumper links (terminals A1, A2 and 15+)
- UL Listing (certain relay/socket combinations)



- 0.1, 2 or 6 A solid state relay
- 12 - 24 V AC/DC supply
- Screw terminal and push-in terminal
- 35 mm rail (EN 60715) mounting

39.80
Screw terminal



39.90
Push-in terminal

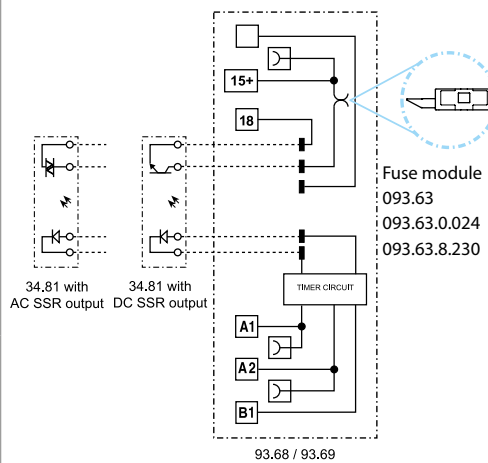

- AI:** On-delay
- DI:** Interval
- GI:** Pulse (0.5 s) delayed
- SW:** Symmetrical flasher (starting pulse on)
- BE:** Off-delay with control signal
- CE:** On- and off-delay with control signal
- DE:** Interval with control signal on
- EE:** Interval with control signal off

For outline drawing see page 25, 26

Output specification (SSR)		39.x0.x.xxx.9024	39.x0.x.xxx.7048	39.x0.x.xxx.8240
Contact configuration		1 NO (SPST-NO)		
Rated current/ Maximum peak current (10 ms)	A	6/50	0.1/0.5	2/80
Rated voltage/ Maximum blocking voltage	V	24/33 DC	48/53 DC	240/— AC
Switching voltage range	V	(1.5...33) DC	(1.5...53) DC	(12...275) AC
Repetitive peak off-state voltage	V _{pk}	—	—	800
Minimum switching current	mA	1	0.05	35
Max. "OFF-state" leakage current	mA	0.001	0.001	1.5
Max. "ON-state" voltage drop	V	0.4	1	1.6
Supply specification				
Nominal voltage (U _N)	V AC/DC	12 - 24		
Rated power	VA (50 Hz)/W	See page 21		
Operating range		(0.8...1.1)U _N		
Holding voltage		0.6 U _N		
Must drop-out voltage		0.1 U _N		
Technical data				
Specified time range		(0.1...3)s, (3...60)s, (1...20)min, (0.3...6)h		
Repeatability	%	± 1		
Recovery time	ms	≤ 50		
Minimum control impulse	ms	50		
Setting accuracy - full range	%	5		
Ambient temperature range	°C	-20...+50		
Protection category		IP 20		
Approvals relay (according to type)				



MasterBASIC - EMR ATEX

1 Pole interface module, 6.2 mm wide, ideal for PLC and electronic systems

ATEX compliant (EX nA nC)

- Electromechanical relay
- AC, DC and AC/DC Version
- Screw terminal and Push-in terminal
- UL Listed
- Cadmium free contacts
- Complies with:
 - EN 60079-0: 2012 and EN 60079-15:2010
 - 94/9/CE and 2014/34/UE
- Common connection possible with optional jumper links (terminals A1, A2 and 11) and multipole connector **MasterADAPTER**
- 35 mm rail (EN 60715) mounting



- 1 CO 6 A
- Screw terminal and push-in terminal
- 35 mm rail (EN 60715) mounting
- ATEX compliant

39.11
Screw terminal



39.01
Push-in terminal

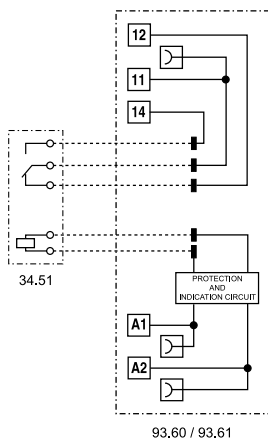

For outline drawing see page 25, 26

Contact specification

Contact configuration		1 CO (SPDT)
Rated current/ Maximum peak current	A	6/10
Rated voltage/ Maximum switching voltage	V AC	250/400
Rated load AC1	VA	1500
Rated load AC15 (230 V AC)	VA	300
Single phase motor rating (230 V AC)	kW	0.185
Breaking capacity DC1: 30/110/220 V	A	6/0.2/0.12
Minimum switching load	mW (V/mA)	500 (12/10)
Standard contact material		AgNi

Coil specification

Nominal voltage (U _N)	V AC/DC	6 - 12 - 24 - 110...125 - 24...240
	V AC (50/60 Hz)	230...240
	V DC	6 - 12 - 24
Rated power AC/DC	VA (50 Hz)/W	See page 20
Operating range		(0.8...1.1)U _N
Holding voltage		0.6 U _N
Must drop-out voltage		0.1 U _N

Technical data

Mechanical life AC/DC	cycles	10 · 10 ⁶
Electrical life at rated load AC1	cycles	60 · 10 ³
Operate/release time	ms	5/6
Insulation between coil and contacts (1.2/50 μs)	kV	6 (8 mm)
Dielectric strength between open contacts	V AC	1000
Ambient temperature range	°C	-40...+70
Protection category		IP 20

Approvals relay (according to type)



Ordering information ATEX versions

Example: 39 series, screw terminals interface module, electromechanical relay output, 1 CO 6 A, 24 V DC, ATEX Version.

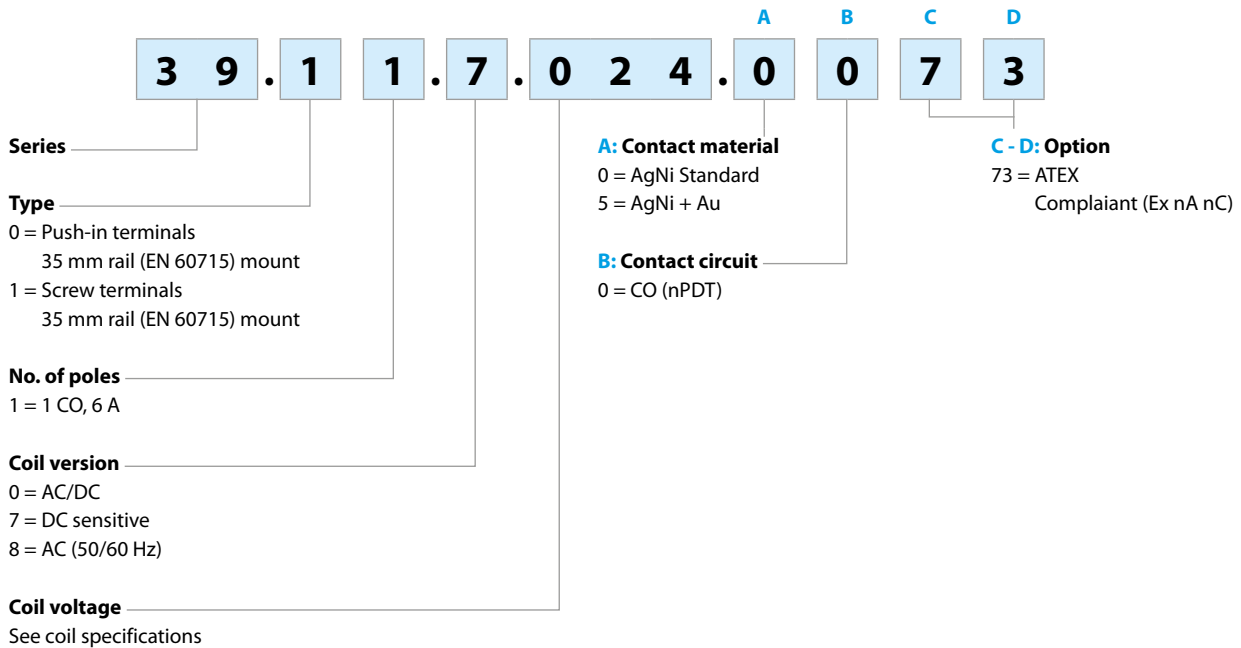

Other data ATEX versions

Max current @ 70 °C	Single piece mount		> 8 piece mount
	Type 39.11/01	A	6
Type 39.11/01 (110...125)V AC/DC only	A	6	4
Terminals	Screw terminals		Push-in Terminals
Wire strip length	mm	10	8
Screw torque	Nm	0.5	—
Min. wire size	solid and stranded cable		solid and stranded cable
	mm ²	0.5	0.5
	AWG	21	21
Max. wire size	solid and stranded cable		solid and stranded cable
	mm ²	1 x 2.5	1 x 2.5
	AWG	1 x 14	1 x 14

Markings - ATEX versions - ATEX, II 3G Ex nA nC IIC Gc

MARKING	
	Specific marking of explosion protection
II	Component for surface plant (different from mines)
3	Category 3: normal level of protection
GAS	G Explosive atmosphere due to presence of combustible gas vapour or mist
	Ex nA Non-sparking equipment
	Ex nC Sealed device (type of protection for category 3G)
	IIC Gas group
	Gc Equipment Protection Level
-40 °C ≤ Ta ≤ +70 °C Ambient temperature	
EPT 15 ATEX 0194 U EPT: laboratory which issues the CE type certificate 15: year of issue of certificate 0194: number of CE type certificate U: ATEX component	

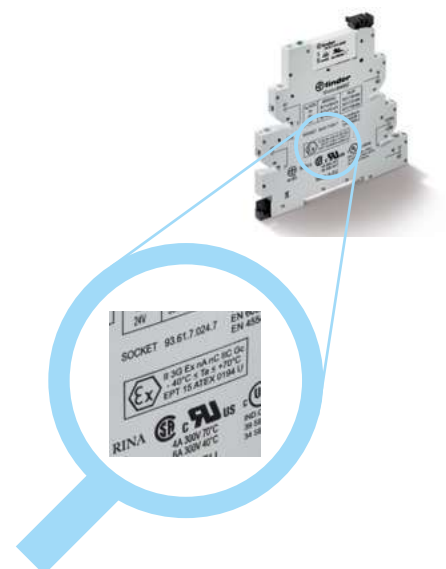

Ordering information

Example: *MasterPLUS* 39 series screw terminal interface module, electromechanical relay output, 1 CO (SPDT), 24 V AC/DC coil.



B

- Series**
- Type**
- 1 = *MasterBASIC*, screw terminal
 - 0 = *MasterBASIC*, push-in terminal
 - 3 = *MasterPLUS*, screw terminal, fuse-protectable output
 - 6 = *MasterPLUS*, push-in terminal, fuse-protectable output
 - 4 = *MasterINPUT*, screw terminal
 - 7 = *MasterINPUT*, push-in terminal
 - 5 = *MasterOUTPUT*, screw terminal
 - 8 = *MasterOUTPUT*, push-in terminal
 - 8 = *MasterTIMER* multifunction, screw terminal, fuse-protectable output
 - 9 = *MasterTIMER* multifunction, push-in terminal, fuse-protectable output

- No. of poles**
- 1 = 1 CO (only EMR, except 39.21/51, 1 NO)
 - 0 = 1 NO (only SSR)

- Coil version, EMR / Input version, SSR**
- 0 = AC (50/60 Hz)/DC
 - 3 = Leakage current suppression AC (50/60 Hz)
 - 7 = DC sensitive
 - 8 = AC (50/60 Hz)

- Coil voltage, EMR/ Input voltage, SSR**
- See page 20

- D: Special Version, EMR**
- 0 = Standard
- C: Options, EMR**
- 6 = Standard
- B: Contact circuit, EMR**
- 0 = CO (except 39.21/51, 1 NO)
- A: Contact material, EMR**
- 0 = AgNi Standard
 - 4 = AgSnO₂
 - 5 = AgNi + Au
- ABCD: Output version, SSR**
- 7048 = 0.1 A - 48 V DC
 - 8240 = 2 A - 230 V AC
 - 9024 = 6 A - 24 V DC

EMR - Selecting features and options: only combinations in the same row are possible.
Preferred selections for best availability are shown in **bold**.

Type	Coil version	A	B	C	D
39.11/01	0.006 - 0.012	0 - 4 - 5	0	6	0
	0.024 - 0.125 - 8.230				
39.31/61	0.006 - 0.012	0 - 4 - 5	0	6	0
	0.024 - 0.060				
	0.125 - 0.240 - 8.230				
	7.125 - 7.220				
39.41/71	0.006 - 0.012	0 - 4 - 5	0	6	0
	0.024 - 0.125				
	8.230				
39.21/51	0.006 - 0.012	0 - 4 - 5	0	6	0
	0.024 - 0.125				
	8.230				
39.81/91	0.012 - 0.024	0	0	6	0

SSR - Selecting features and options: only combinations in the same row are possible.
Preferred selections for best availability are shown in **bold**.

Type	Input version	Output version, ABCD
39.10/00	7.006 - 7.012	7048 - 8240 - 9024
	7.024 - 0.125 - 8.230	
39.30/60	7.006 - 7.012	7048 - 8240 - 9024
	7.024 - 7.060	
	7.125 - 7.220	
	0.024 - 0.125 - 0.240	
	8.230	
39.40/70	7.006 - 7.012	7048 - 8240 - 9024
	7.024 - 0.024 - 0.125	
	8.230	
39.20/50	7.006 - 7.012	7048 - 8240 - 9024
	7.024 - 0.125	
39.80/90	0.012 - 0.024	7048 - 8240 - 9024

Technical data

Insulation according to EN 61810-1			
Nominal voltage of supply system	V AC	230/400	
Rated insulation voltage	V AC	250	400
Pollution degree		3	2
Insulation between coil and contact set			
Type of Insulation		Reinforced	
Overvoltage category		III	
Rated impulse voltage	kV (1.2/50) μ s	6	
Dielectric strength	V AC	4000	
Insulation between open contacts (EMR)			
Type of disconnection		Micro-disconnection	
Dielectric strength	V AC/kV (1.2/50) μ s	1000/1.5	

Conducted disturbance immunity	$U_N \leq 60$ V	$U_N = 125$ V	$U_N = 230$ V	
Fast transients (burst 5/50 ns, 5 kHz) according to EN 61000-4-4 at supply terminals	kV	4	4	4
Voltage pulses (surge 1.2/50 μ s) according to EN 61000-4-5 at supply terminals (differential mode)	kV	0.8	2	4

Other data			
Bounce time (EMR): NO/NC	ms	1/6	
Vibration resistance (EMR, 10...55 Hz): NO/NC	g	10/15	
Power lost to the environment	without contact current	W	0.2 (24 V) - 0.4 (230 V)
	with rated current	W	0.6 (24 V) - 0.9 (230 V)

Terminals			
		Screw terminal	Push-in terminal
Wire strip length	mm	10	8
Screw torque	Nm	0.5	—
		Solid and stranded cable	Solid and stranded cable
Min. wire size	mm ²	1 x 0.5	1 x 0.5
	AWG	1 x 21	1 x 21
Max. wire size	mm ²	1 x 2.5	1 x 2.5
	AWG	1 x 14	1 x 14

Contact specification (EMR)

F 39 - Electrical life (AC) v contact current

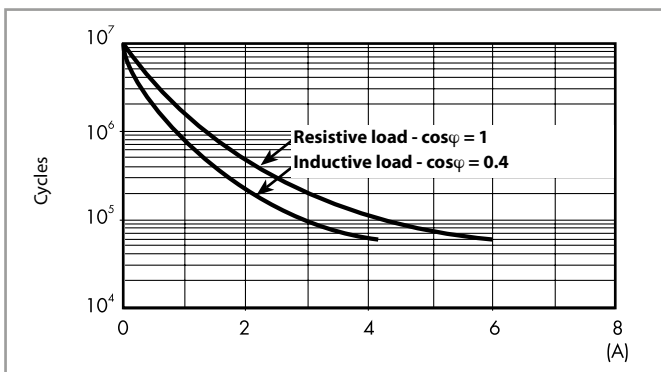

H 39 - Maximum DC1 breaking capacity

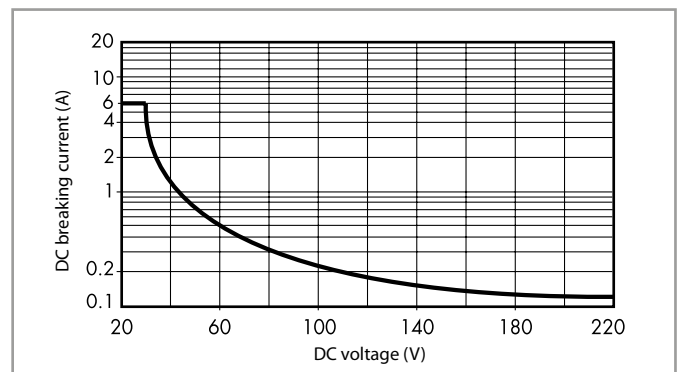

- When switching a resistive load (DC1) having voltage and current values under the curve, an electrical life of $\geq 60 \cdot 10^3$ can be expected.
- In the case of DC13 loads, the connection of a diode in parallel with the load will permit a similar electrical life as for a DC1 load.
Note: the release time for the load will be increased.

Coil specifications - Electromechanical Relay

Coil data DC, type 39.31/61

Nominal voltage U_N	Coil code	Operating range		Must drop-out voltage U_r	Rated input current at U_N I_N	Rated power at U_N at U_N
		U_{min}	U_{max}			
V		V	V	V	mA	W
125 (110...125)	7.125	88	138	12.5	4.6	0.6
220	7.220	176	242	22	3.0	0.6

Coil data AC/DC, type 39.11/21/31/41/01/51/61/71

Nominal voltage U_N	Coil code	Operating range		Must drop-out voltage U_r	Rated input current at U_N I_N	Rated power at U_N at U_N
		U_{min}	U_{max}			
V		V	V	V	mA	VA/W
6	0.006	4.8	6.6	0.6	35	0.2/0.2
12	0.012	9.6	13.2	1.5	15	0.2/0.2
24	0.024	19.2	26.4	2.4	11	0.25/0.25
60 ⁽¹⁾	0.060	48	66	6.0	5.7	0.35/0.35
125 (110...125)	0.125	88	138	12.5	5.6	0.7/0.7
240 (24...240) ⁽²⁾	0.240	20.4	264	2.4	19	1.5/0.3

⁽¹⁾ 60 V AC/DC for type 39.31/61 only

⁽²⁾ 24...240 V AC/DC for type 39.31/61 only

Coil data AC, type 39.11/21/31/41/01/51/61/71

Nominal voltage U_N	Coil code	Operating range		Must drop-out voltage U_r	Rated input current at U_N I_N	Rated power at U_N at U_N
		U_{min}	U_{max}			
V		V	V	V	mA	VA/W
230 (230...240)	8.230	184	264	23	4.3	1/0.4

Coil data leakage current suppression versions, type 39.31.3/61.3

Nominal voltage U_N	Coil code	Operating range		Must drop-out voltage U_r	Rated input current at U_N I_N	Rated power at U_N at U_N
		U_{min}	U_{max}			
V		V	V	V	mA	VA/W
125 (110...125)	3.125	88	138	44	8.4	1.1/1
230 (230...240)	3.230	184	264	72	5.9	1.4/0.5

The 39 Series interface modules (supply version 3) have built-in leakage current suppression to address industry concerns of the contacts not dropping-out when there is residual current in the circuit; at (110...125)V AC/DC and (230...240)V AC.

This problem can occur, for example, when connecting the interface modules to PLC's with triac outputs or when connecting via relatively long cables.

Coil data AC/DC timer, type 39.81/91

Nominal voltage U_N	Coil code	Operating range (AC/DC)		Must drop-out voltage U_r	Rated input current at U_N		Rated power at U_N	
		U_{min}	U_{max}		DC	AC	DC	AC
V		V	V	V	mA	mA	W	VA/W
12	0.012	9.6	13.2	1.2	15	23	0.2	0.3/0.2
24	0.024	19.2	26.4	2.4	11	19	0.25	0.4/0.3

Input specifications - Solid State Relay

Input data DC, type 39.10/20/30/40/00/50/60/70

Nominal voltage U_N	Input code	Operating range		Must drop-out voltage U_r	Rated input current at U_N		Rated power at U_N
		U_{min}	U_{max}		I_N		
V		V	V	V	mA	W	
6	7.006	4.8	6.6	0.6	7.5	0.2	
12	7.012	9.6	13.2	1.2	20.7	0.25	
24	7.024	19.2	26.4	2.4	10.5	0.25	
60 ⁽¹⁾	7.060	38	66	6.0	6.4	0.4	
125 ⁽¹⁾ (110...125)	7.125	88	138	12.5	4.6	0.6	
220 ⁽¹⁾	7.220	176	242	22	3.0	0.6	

⁽¹⁾ 60 V DC, 125 V DC and 220 V DC for type 39.30/60 only

Input data AC/DC, type 39.10/20/30/40/00/50/60/70

Nominal voltage U_N	Input code	Operating range		Must drop-out voltage U_r	Rated input current at U_N		Rated power at U_N
		U_{min}	U_{max}		I_N		
V		V	V	V	mA	VA/W	
24 ⁽²⁾	0.024	19.2	26.4	2.4	17.5	0.4/0.3	
125 (110...125)	0.125	88	138	12.5	5.5	0.7/0.7	
240 (24...240) ⁽³⁾	0.240	20.4	264	2.4	17.5	1.5/0.3	

⁽²⁾ 24 V AC/DC for type 39.30/40/60/70 only

⁽³⁾ 24...240 V AC/DC for type 39.30/60 only

Input data AC, type 39.10/20/30/40/00/50/60/70

Nominal voltage U_N	Input code	Operating range		Must drop-out voltage U_r	Rated input current at U_N		Rated power at U_N
		U_{min}	U_{max}		I_N		
V		V	V	V	mA	VA/W	
230 (230...240)	8.230	184	264	23	4.2	1/0.4	

Input data leakage current suppression versions, type 39.30.3/60.3

Nominal voltage U_N	Input code	Operating range		Must drop-out voltage U_r	Rated input current at U_N		Rated power at U_N
		U_{min}	U_{max}		I_N		
V		V	V	V	mA	VA/W	
125 (110...125)	3.125	88	138	44	8.4	1.1/1	
230 (230...240)	3.230	184	264	72	5.9	1.4/0.5	

The 39 Series interface modules (supply version 3) have built-in leakage current suppression to address industry concerns of the contacts not dropping-out when there is residual current in the circuit; at (110...125)V AC/DC and (230...240)V AC.

This problem can occur, for example, when connecting the interface modules to PLC's with triac outputs or when connecting via relatively long cables.

Input data AC/DC timer, type 39.80/90

Nominal voltage U_N	Input code	Operating range (AC/DC)		Must drop-out voltage U_r	Rated input current at U_N		Rated power at U_N	
		U_{min}	U_{max}		DC	AC	DC	AC
V		V	V	V	mA	mA	W	VA/W
12	0.012	9.6	13.2	1.2	15	23	0.2	0.3/0.2
24	0.024	19.2	26.4	2.4	11	19	0.25	0.4/0.3

Output specification - Solid State Relays

L 34-1 - Output DC current v ambient temperature

39.xx.x.xxx.9024

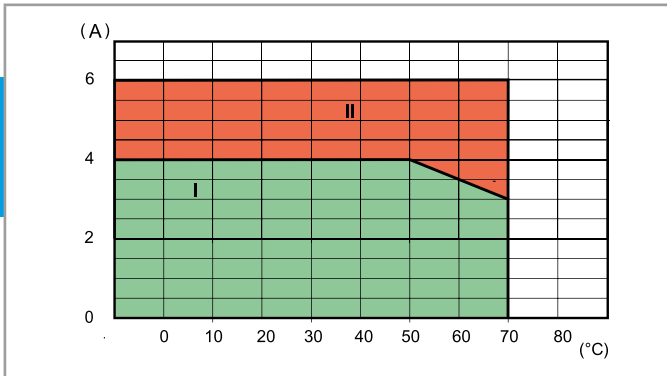

L 34 - Output AC current v ambient temperature

39.xx.x.xxx.8240

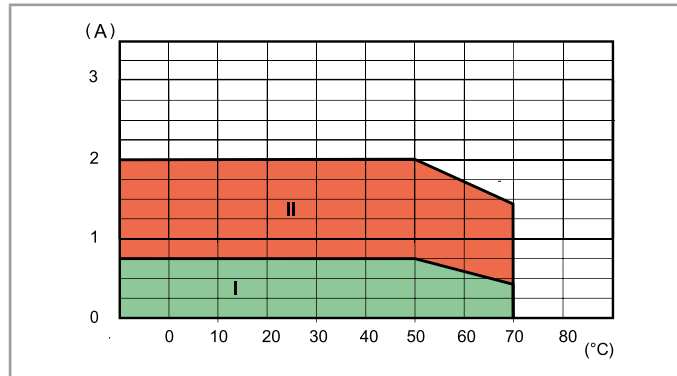

I: SSR installed as a group (without gap between sockets)

II: SSR installed individually in free air, or with a gap ≥ 9 mm, which implies a not significant influence from nearby components

Max recommended switching frequency (Cycles/Hour, with 50% Duty-cycle) at ambient temperature 50°C, single mounting

Load	39.xx.x.xxx.9024	39.xx.x.xxx.8240	39.xx.x.xxx.7048
24 V 6 A DC1	180 000	—	—
24 V 3 A DC L/R = 10 ms	5000	—	—
24 V 2 A DC L/R = 40 ms	3600	—	—
24 V 1 A DC L/R = 40 ms	6500	—	—
24 V 0.8 A DC L/R = 40 ms	9000	—	—
24 V 1.5 A DC L/R = 80 ms	3250	—	—
230 V 2 A AC1	—	60 000	—
230 V 1.25 A AC15	—	3600	—
48 V 0.1 A DC1	—	—	60 000

B

Timer specifications

EMC specifications

Type of test	Reference standard		
Electrostatic discharge	contact discharge	EN 61000-4-2	4 kV
	air discharge	EN 61000-4-2	8 kV
Radio-frequency electromagnetic field	(80 ÷ 1000 MHz)	EN 61000-4-3	10 V/m
	(1400 ÷ 2700 MHz)	EN 61000-4-3	10 V/m
Fast transients (burst) (5-50 ns, 5 and 100 kHz)	on Supply terminals	EN 61000-4-4	4 kV
	on control signal terminals	EN 61000-4-4	4 kV
Surges (1.2/50 µs) on supply and control signal terminals	common mode	EN 61000-4-5	2 kV
	differential mode	EN 61000-4-5	0.8 kV
Radio-frequency common mode (0.15 ÷ 80 MHz)	on Supply terminals	EN 61000-4-6	10 V
	on control signal terminals	EN 61000-4-6	3 V
Radiated and conducted emission	EN 55022	class B	

Other data

Bounce time (EMR): NO/NC	ms	1/6
Vibration resistance (EMR, 10...55 Hz): NO/NC	g	10/15
Power lost to the environment	without contact current	W 0.3
	with rated current	W 0.8

Terminals

		Screw terminal	Push-in terminal
		Wire strip length	mm 10
Screw torque	Nm	0.5	—
		Solid and stranded cable	Solid and stranded cable
Min. wire size	mm ²	1 x 0.5	1 x 0.5
	AWG	1 x 21	1 x 21
Max. wire size	mm ²	1 x 2.5	1 x 2.5
	AWG	1 x 14	1 x 14

Times scales



Functions

LED	Supply voltage	NO contact/output
	OFF	Open
	ON	Open
	ON	Open (timing to close in progress)
	ON	Closed

Wiring diagram

U = Supply voltage

S = Signal switch

= Output contact

Without control signal

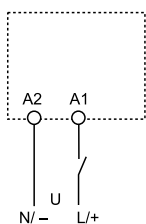

(AI) On-delay
Apply power to timer. Output contacts transfer after preset time has elapsed. Reset occurs when power is removed.

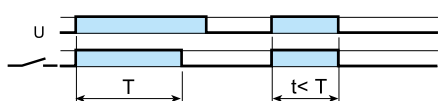

(DI) Interval
Apply power to timer. Output contacts transfer immediately. After the preset time has elapsed, contacts reset.

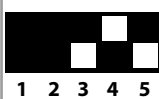

(GI) Pulse (0.5 s) delayed
Apply power to timer. Output contacts transfer after preset time has elapsed. Reset occurs after a fixed time of 0.5 s.

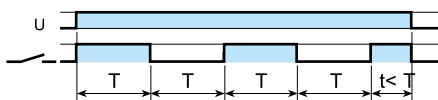
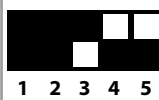

(SW) Symmetrical flasher (starting pulse on)
Apply power to timer. Output contacts transfer immediately and cycle between ON and OFF for as long as power is applied. The ratio is 1:1 (time on = time off).

With control signal

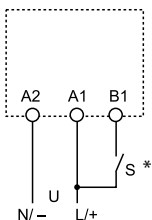

* With DC supply, positive polarity has to be connected to B1, terminal (according to EN 60204-1).

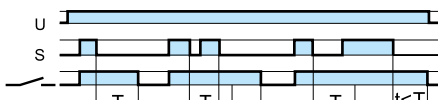

(BE) Off-delay with control signal
Power is permanently applied to the timer. The output contacts transfer immediately on closure of the Signal Switch (S). Opening the Signal Switch initiates the preset delay, after which time the output contacts reset.

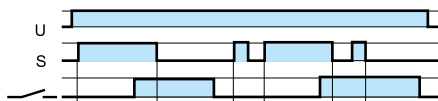

(CE) On- and off-delay with control signal
Power is permanently applied to the timer. Closing the Signal Switch (S) initiates the preset delay, after which time the output contacts transfer. Opening the Signal Switch initiates the same preset delay, after which time the output contacts reset.

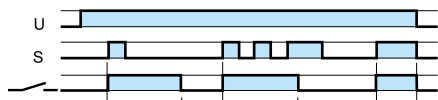

(DE) Interval with control signal on
Power is permanently applied to the timer. On momentary or maintained closure of Signal Switch (S), the output contacts transfer, and remain so for the duration of the preset delay, after which they reset.

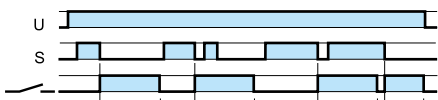

(EE) Interval with control signal off
Power is permanently applied to the timer. On opening of the Signal Switch (S) the output contacts transfer, and remain so for the duration of the preset delay, after which they reset.

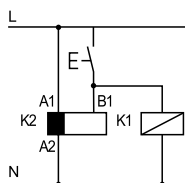

• Possible to control an external load, such as another relay coil or timer, connected to the control signal terminal B1.

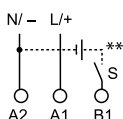

** A voltage other than the supply voltage can be applied to the command Start (B1), example:
A1 - A2 = 24 V AC
B1 - A2 = 12 V DC

Outline drawings - Screw terminal sockets

39.10/39.20
39.11/39.21
Screw terminal

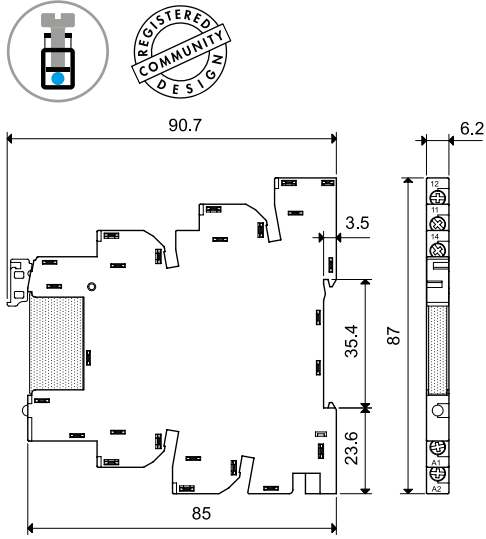

39.30/39.30.3
39.31/39.31.3
Screw terminal

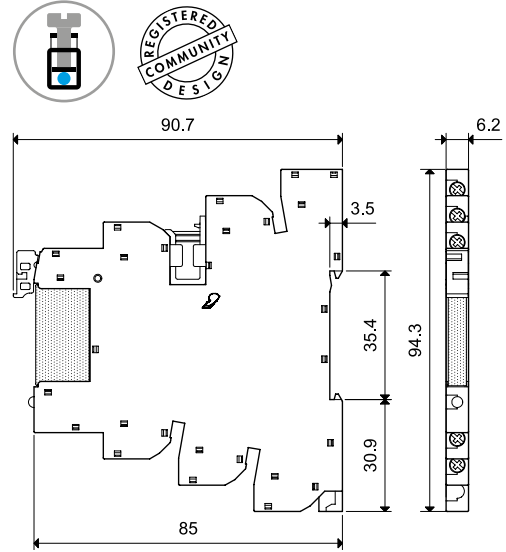

39.40
39.41
Screw terminal

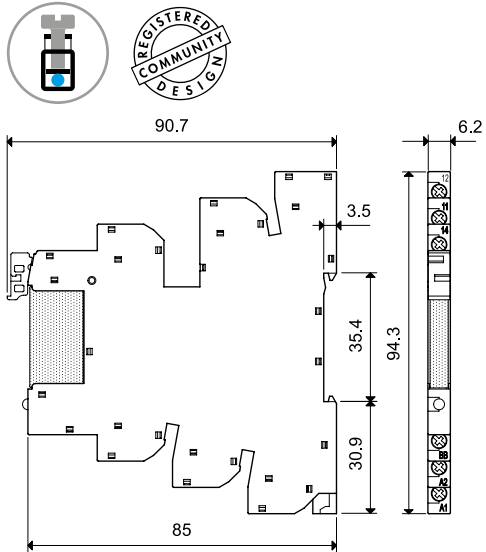

39.80
39.81
Screw terminal

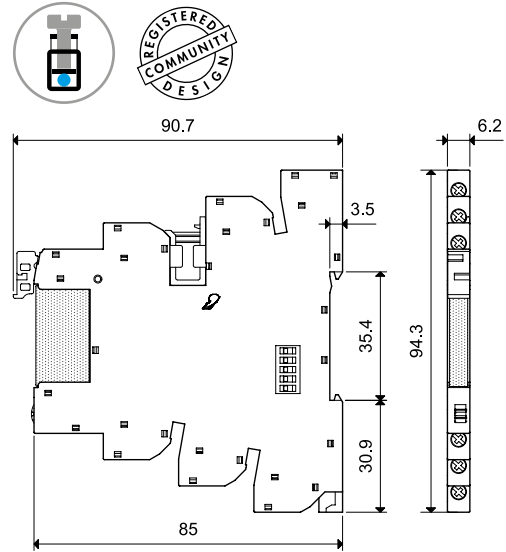

B

Outline drawings - Push-in terminal sockets

39.00/39.01
39.50/39.51
Push-in terminal

39.60/39.60.3
39.61/39.61.3
Push-in terminal

B

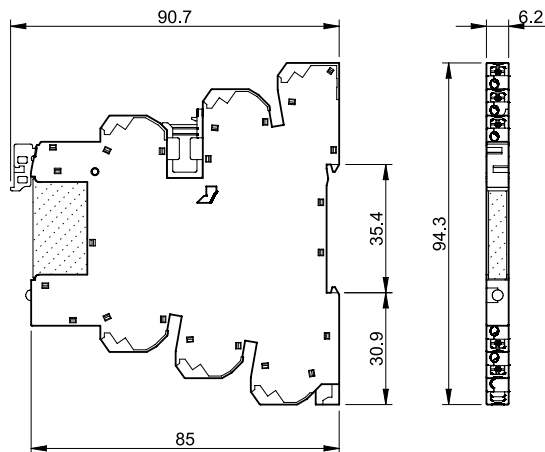
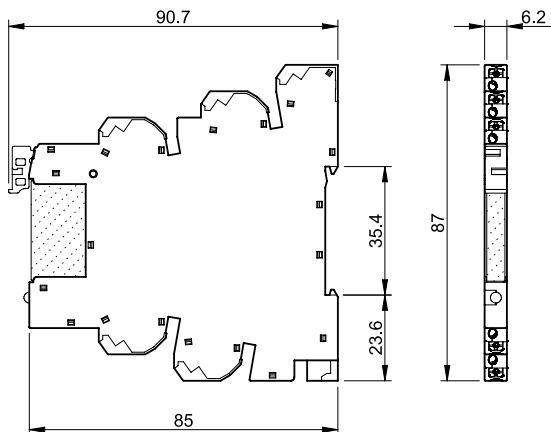

39.70
39.71
Push-in terminal

39.90
39.91
Push-in terminal

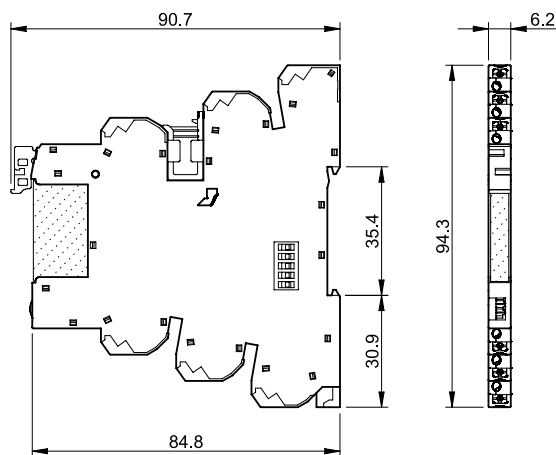
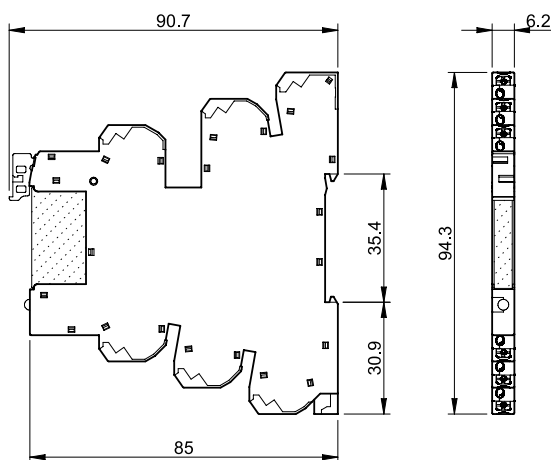

Main features

Push-in terminals

The push-in terminals permit the quick connection of solid wires or ferrules by their simple insertion into the terminal (A). It is possible to open the terminal to extract the wire by first pushing down on the push-button using a screwdriver (C). For stranded cable it is necessary first to open the terminal using the push button, both for the extraction (C) and insertion (B). It is possible at any time to check the connection via the test aperture, using a 2 mm diameter test probe (D).

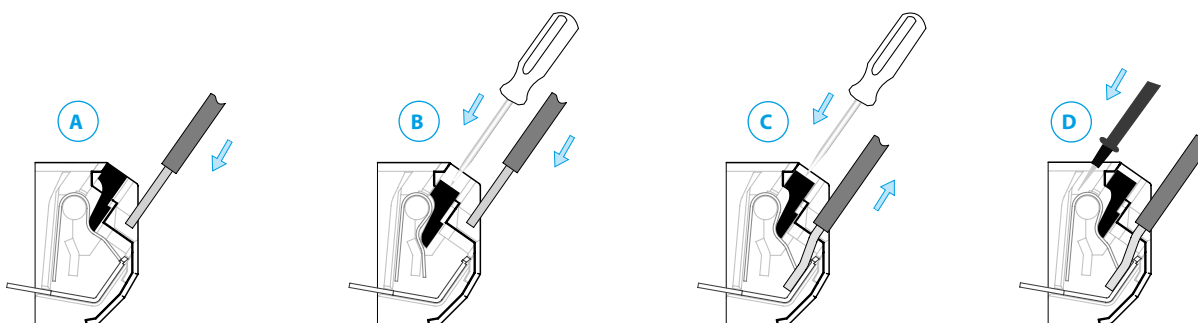

Electromechanical Relay (1 Pole 6 A) & Screw Socket Combinations

Interface Module Code	Coil voltage	Relay	Socket
MasterBASIC			
39.11.0.006.0060	6 V AC/DC	34.51.7.005.0010	93.61.7.024
39.11.0.012.0060	12 V AC/DC	34.51.7.012.0010	93.61.7.024
39.11.0.024.0060	24 V AC/DC	34.51.7.024.0010	93.61.7.024
39.11.0.125.0060	(110...125)V AC/DC	34.51.7.060.0010	93.61.0.125
39.11.8.230.0060	(230...240)V AC	34.51.7.060.0010	93.61.8.230
MasterPLUS			
39.31.0.006.0060	6 V AC/DC	34.51.7.005.0010	93.63.7.024
39.31.0.012.0060	12 V AC/DC	34.51.7.012.0010	93.63.7.024
39.31.0.024.0060	24 V AC/DC	34.51.7.024.0010	93.63.7.024
39.31.0.060.0060	60 V AC/DC	34.51.7.060.0010	93.63.7.060
39.31.0.125.0060	(110...125)V AC/DC	34.51.7.060.0010	93.63.0.125
39.31.0.240.0060	(24...240)V AC/DC	34.51.7.024.0010	93.63.0.240
39.31.8.230.0060	(230...240)V AC	34.51.7.060.0010	93.63.8.230
39.31.7.125.0060	(110...125)V DC	34.51.7.060.0010	93.63.7.125
39.31.7.220.0060	220 V DC	34.51.7.060.0010	93.63.7.220
39.31.3.125.0060	(110...125)V AC/DC	34.51.7.060.0010	93.63.3.125
39.31.3.230.0060	(230...240)V AC	34.51.7.060.0010	93.63.3.230
MasterINPUT			
39.41.0.006.5060	6 V AC/DC	34.51.7.005.5010	93.64.7.024
39.41.0.012.5060	12 V AC/DC	34.51.7.012.5010	93.64.7.024
39.41.0.024.5060	24 V AC/DC	34.51.7.024.5010	93.64.7.024
39.41.0.125.5060	(110...125)V AC/DC	34.51.7.060.5010	93.64.0.125
39.41.8.230.5060	(230...240)V AC	34.51.7.060.5010	93.64.8.230
MasterOUTPUT 1 NO, 6 A only			
39.21.0.006.0060	6 V AC/DC	34.51.7.005.0010	93.62.7.024
39.21.0.012.0060	12 V AC/DC	34.51.7.012.0010	93.62.7.024
39.21.0.024.0060	24 V AC/DC	34.51.7.024.0010	93.62.7.024
39.21.0.125.0060	(110...125)V AC/DC	34.51.7.060.0010	93.62.0.125
39.21.8.230.0060	(230...240)V AC	34.51.7.060.0010	93.62.8.230
MasterTIMER			
39.81.0.012.0060	12 V AC/DC	34.51.7.012.0010	93.68.0.024
39.81.0.024.0060	24 V AC/DC	34.51.7.024.0010	93.68.0.024

Solid State Relay (1 Pole 0.1, 2 or 6 A) & Screw Socket Combinations

Interface Module Code	Input voltage	Relay	Socket
MasterBASIC			
39.10.7.006.xxxx	6 V DC	34.81.7.005.xxxx	93.61.7.024
39.10.7.012.xxxx	12 V DC	34.81.7.012.xxxx	93.61.7.024
39.10.7.024.xxxx	24 V DC	34.81.7.024.xxxx	93.61.7.024
39.10.0.125.xxxx	(110...125)V AC/DC	34.81.7.060.xxxx	93.61.0.125
39.10.8.230.xxxx	(230...240)V AC	34.81.7.060.xxxx	93.61.8.230
MasterPLUS			
39.30.7.006.xxxx	6 V DC	34.81.7.005.xxxx	93.63.7.024
39.30.7.012.xxxx	12 V DC	34.81.7.012.xxxx	93.63.7.024
39.30.7.024.xxxx	24 V DC	34.81.7.024.xxxx	93.63.7.024
39.30.7.060.xxxx	60 V DC	34.81.7.060.xxxx	93.63.7.060
39.30.7.125.xxxx	(110...125)V DC	34.81.7.060.xxxx	93.63.7.125
39.30.7.220.xxxx	220 V DC	34.81.7.060.xxxx	93.63.7.220
39.30.0.024.xxxx	24 V AC/DC	34.81.7.024.xxxx	93.63.0.024
39.30.0.125.xxxx	(110...125)V AC/DC	34.81.7.060.xxxx	93.63.0.125
39.30.0.240.xxxx	(24...240)V AC/DC	34.81.7.024.xxxx	93.63.0.240
39.30.8.230.xxxx	(230...240)V AC	34.81.7.060.xxxx	93.63.8.230
39.30.3.125.xxxx	(110...125)V AC/DC	34.81.7.060.xxxx	93.63.3.125
39.30.3.230.xxxx	(230...240)V AC	34.81.7.060.xxxx	93.63.3.230
MasterINPUT			
39.40.7.006.xxxx	6 V DC	34.81.7.005.xxxx	93.64.7.024
39.40.7.012.xxxx	12 V DC	34.81.7.012.xxxx	93.64.7.024
39.40.7.024.xxxx	24 V DC	34.81.7.024.xxxx	93.64.7.024
39.40.0.024.xxxx	24 V AC/DC	34.81.7.024.xxxx	93.64.0.024
39.40.0.125.xxxx	(110...125)V AC/DC	34.81.7.060.xxxx	93.64.0.125
39.40.8.230.xxxx	(230...240)V AC	34.81.7.060.xxxx	93.64.8.230
MasterOUTPUT			
39.20.7.006.xxxx	6 V DC	34.81.7.005.xxxx	93.62.7.024
39.20.7.012.xxxx	12 V DC	34.81.7.012.xxxx	93.62.7.024
39.20.7.024.xxxx	24 V DC	34.81.7.024.xxxx	93.62.7.024
39.20.0.125.xxxx	(110...125)V AC/DC	34.81.7.060.xxxx	93.62.0.125
39.20.8.230.xxxx	(230...240)V AC	34.81.7.060.xxxx	93.62.8.230
MasterTIMER			
39.80.0.012.xxxx	12 V AC/DC	34.81.7.012.xxxx	93.68.0.024
39.80.0.024.xxxx	24 V AC/DC	34.81.7.024.xxxx	93.68.0.024

Electromechanical Relay (1 Pole 6 A) & Push-in Socket Combinations

Interface Module Code	Coil voltage	Relay	Socket
MasterBASIC			
39.01.0.006.0060	6 V AC/DC	34.51.7.005.0010	93.60.7.024
39.01.0.012.0060	12 V AC/DC	34.51.7.012.0010	93.60.7.024
39.01.0.024.0060	24 V AC/DC	34.51.7.024.0010	93.60.7.024
39.01.0.125.0060	(110...125)V AC/DC	34.51.7.060.0010	93.60.0.125
39.01.8.230.0060	(230...240)V AC	34.51.7.060.0010	93.60.8.230
MasterPLUS			
39.61.0.006.0060	6 V AC/DC	34.51.7.005.0010	93.66.7.024
39.61.0.012.0060	12 V AC/DC	34.51.7.012.0010	93.66.7.024
39.61.0.024.0060	24 V AC/DC	34.51.7.024.0010	93.66.7.024
39.61.0.060.0060	60 V AC/DC	34.51.7.060.0010	93.66.7.060
39.61.0.125.0060	(110...125)V AC/DC	34.51.7.060.0010	93.66.0.125
39.61.0.240.0060	(24...240)V AC/DC	34.51.7.024.0010	93.66.0.240
39.61.8.230.0060	(230...240)V AC	34.51.7.060.0010	93.66.8.230
39.61.7.125.0060	(110...125)V DC	34.51.7.060.0010	93.66.7.125
39.61.7.220.0060	220 V DC	34.51.7.060.0010	93.66.7.220
39.61.3.125.0060	(110...125)V AC/DC	34.51.7.060.0010	93.66.3.125
39.61.3.230.0060	(230...240)V AC	34.51.7.060.0010	93.66.3.230
MasterINPUT			
39.71.0.006.5060	6 V AC/DC	34.51.7.005.5010	93.67.7.024
39.71.0.012.5060	12 V AC/DC	34.51.7.012.5010	93.67.7.024
39.71.0.024.5060	24 V AC/DC	34.51.7.024.5010	93.67.7.024
39.71.0.125.5060	(110...125)V AC/DC	34.51.7.060.5010	93.67.0.125
39.71.8.230.5060	(230...240)V AC	34.51.7.060.5010	93.67.8.230
MasterOUTPUT 1 NO, 6 A only			
39.51.0.006.0060	6 V AC/DC	34.51.7.005.0010	93.65.7.024
39.51.0.012.0060	12 V AC/DC	34.51.7.012.0010	93.65.7.024
39.51.0.024.0060	24 V AC/DC	34.51.7.024.0010	93.65.7.024
39.51.0.125.0060	(110...125)V AC/DC	34.51.7.060.0010	93.65.0.125
39.51.8.230.0060	(230...240)V AC	34.51.7.060.0010	93.65.8.230
MasterTIMER			
39.91.0.012.0060	12 V AC/DC	34.51.7.012.0010	93.69.0.024
39.91.0.024.0060	24 V AC/DC	34.51.7.024.0010	93.69.0.024

Solid State Relay (1 Pole 0.1, 2 or 6 A) & Push-in Socket Combinations

Interface Module Code	Input voltage	Relay	Socket
MasterBASIC			
39.00.7.006.xxxx	6 V DC	34.81.7.005.xxxx	93.60.7.024
39.00.7.012.xxxx	12 V DC	34.81.7.012.xxxx	93.60.7.024
39.00.7.024.xxxx	24 V DC	34.81.7.024.xxxx	93.60.7.024
39.00.0.125.xxxx	(110...125)V AC/DC	34.81.7.060.xxxx	93.60.0.125
39.00.8.230.xxxx	(230...240)V AC	34.81.7.060.xxxx	93.60.8.230
MasterPLUS			
39.60.7.006.xxxx	6 V DC	34.81.7.005.xxxx	93.66.7.024
39.60.7.012.xxxx	12 V DC	34.81.7.012.xxxx	93.66.7.024
39.60.7.024.xxxx	24 V DC	34.81.7.024.xxxx	93.66.7.024
39.60.7.060.xxxx	60 V DC	34.81.7.060.xxxx	93.66.7.060
39.60.7.125.xxxx	(110...125)V DC	34.81.7.060.xxxx	93.66.7.125
39.60.7.220.xxxx	220 V DC	34.81.7.060.xxxx	93.66.7.220
39.60.0.024.xxxx	24 V AC/DC	34.81.7.024.xxxx	93.66.0.024
39.60.0.125.xxxx	(110...125)V AC/DC	34.81.7.060.xxxx	93.66.0.125
39.60.0.240.xxxx	(24...240)V AC/DC	34.81.7.024.xxxx	93.66.0.240
39.60.8.230.xxxx	(230...240)V AC	34.81.7.060.xxxx	93.66.8.230
39.60.3.125.xxxx	(110...125)V AC/DC	34.81.7.060.xxxx	93.66.3.125
39.60.3.230.xxxx	(230...240)V AC	34.81.7.060.xxxx	93.66.3.230
MasterINPUT			
39.70.7.006.xxxx	6 V DC	34.81.7.005.xxxx	93.67.7.024
39.70.7.012.xxxx	12 V DC	34.81.7.012.xxxx	93.67.7.024
39.70.7.024.xxxx	24 V DC	34.81.7.024.xxxx	93.67.7.024
39.70.0.024.xxxx	24 V AC/DC	34.81.7.024.xxxx	93.67.0.024
39.70.0.125.xxxx	(110...125)V AC/DC	34.81.7.060.xxxx	93.67.0.125
39.70.8.230.xxxx	(230...240)V AC	34.81.7.060.xxxx	93.67.8.230
MasterOUTPUT			
39.50.7.006.xxxx	6 V DC	34.81.7.005.xxxx	93.65.7.024
39.50.7.012.xxxx	12 V DC	34.81.7.012.xxxx	93.65.7.024
39.50.7.024.xxxx	24 V DC	34.81.7.024.xxxx	93.65.7.024
39.50.0.125.xxxx	(110...125)V AC/DC	34.81.7.060.xxxx	93.65.0.125
39.50.8.230.xxxx	(230...240)V AC	34.81.7.060.xxxx	93.65.8.230
MasterTIMER			
39.90.0.012.xxxx	12 V AC/DC	34.81.7.012.xxxx	93.69.0.024
39.90.0.024.xxxx	24 V AC/DC	34.81.7.024.xxxx	93.69.0.024

Example: .xxxx
.9024
.7048
.8240

MasterBASIC ATEX version, Screw Socket Combinations

Interface Module Code	Coil voltage	Relay	Socket
<i>MasterBASIC ATEX</i>			
39.11.0.006.0073	6 V AC/DC	34.51.7.005.0000	93.61.0.024.7
39.11.0.012.0073	12 V AC/DC	34.51.7.012.0000	93.61.0.024.7
39.11.0.024.0073	24 V AC/DC	34.51.7.024.0000	93.61.0.024.7
39.11.0.125.0073	(110...125)V AC/DC	34.51.7.060.0000	93.61.0.125.7
39.11.0.240.0073	(24...240)V AC/DC	34.51.7.024.0000	93.61.0.240.7
39.11.8.230.0073	(230...240)V AC	34.51.7.060.0000	93.61.8.230.7
39.11.7.006.0073	6 V DC	34.51.7.005.0000	93.61.7.024.7
39.11.7.012.0073	12 V DC	34.51.7.012.0000	93.61.7.024.7
39.11.7.024.0073	24 V DC	34.51.7.024.0000	93.61.7.024.7

MasterBASIC ATEX version, Push-in Socket Combinations

Interface Module Code	Input voltage	Relay	Socket
<i>MasterBASIC ATEX</i>			
39.01.0.006.0073	6 V AC/DC	34.51.7.005.0000	93.60.0.024.7
39.01.0.012.0073	12 V AC/DC	34.51.7.012.0000	93.60.0.024.7
39.01.0.024.0073	24 V AC/DC	34.51.7.024.0000	93.60.0.024.7
39.01.0.125.0073	(110...125)V AC/DC	34.51.7.060.0000	93.60.0.125.7
39.01.0.240.0073	(24...240)V AC/DC	34.51.7.024.0000	93.60.0.240.7
39.01.8.230.0073	(230...240)V AC	34.51.7.060.0000	93.60.8.230.7
39.01.7.006.0073	6 V DC	34.51.7.005.0000	93.60.7.024.7
39.01.7.012.0073	12 V DC	34.51.7.012.0000	93.60.7.024.7
39.01.7.024.0073	24 V DC	34.51.7.024.0000	93.60.7.024.7

B

Accessories



Output fuse module for 39.31/30/81/80/61/60/91/90 types	093.63	093.63.0.024	093.63.8.230
--	--------	--------------	--------------

- For 5 x 20 mm fuses up to 6 A, 250 V
- Type 093.63 - Easy visibility of the fuse condition through the window
- Type 093.63.0.024 - (6...24)V AC/DC with LED fuse status indicator
- Type 093.63.8.230 - (110...240)V AC with LED fuse status indicator
- Quick connection to socket

Notes

Safety: Because the output circuit can be reinstated (point 3 below), even with the fuse removed, it is important not to consider the removal of the fuse as a "safety disconnect". Always isolate elsewhere before working on the circuit.

UL: According to UL508A, the fuse module cannot be installed in power circuits (in which it is mandatory that a fuse certified according to UL category JDDZ be fitted). However, where the MasterInterface is connected as an output interface to a PLC no such restrictions apply, and the fuse module can be usefully employed.

Type 093.63

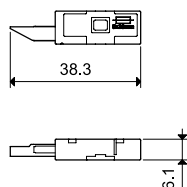

Type 093.63.0.24 / 093.63.8.230

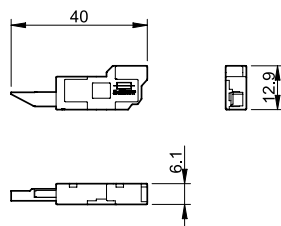

B 093.63
Approvals
(according to type):
CE ENEC cULUS



093.63.0.024
093.63.8.230

Multi-state fuse module

- 0.** As delivered, the socket comes without a fuse module. However, the absent fuse is internally replaced with an electrical link - which allows the interface relay to be used without a fuse module.
In this state, the peg/indicator is visually hidden and the connection is protected by a special cap.

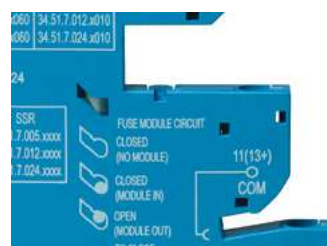

- 1.** With fuse module inserted after removing the cap, the fuse is positioned electrically in series with the common output terminal of the interface module (11 for EMR versions, 13+ for SSR versions, 15 for EMR timer, 15+ for SSR timer).
This state is indicated by the peg/indicator.

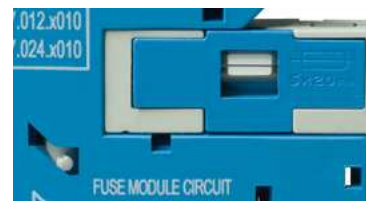

- 2.** If the fuse module is extracted (for example; because the fuse element has blown) the output circuit will be locked open, as this will generally be the "safe option".
This state is indicated by the peg/indicator.

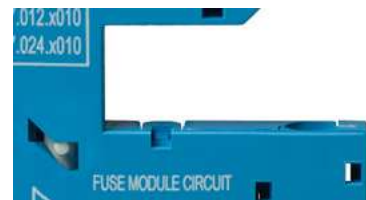

- 3.** In order to reinstate the output circuit it is necessary to either re-insert the fuse module (complete with functional fuse), or alternatively, return the peg/indicator to position 0 by gently applying pressure in the direction of the arrow.



Accessories



093.16



093.16.0



093.16.1

Approvals
(according to type):



16-way jumper link	093.16 (blue)	093.16.0 (black)	093.16.1 (red)
Rated values	6 A - 250 V		
Possibility of multiple connection, side by side			

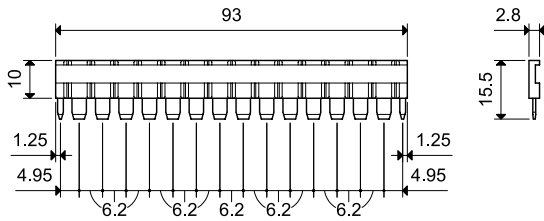

093.60

Dual-purpose plastic separator (1.8 mm or 6.2 mm separation)	093.60
---	--------

1. By breaking off the protruding ribs (by hand), the separator becomes only 1.8 mm thick; useful for the visual separation of different groups of interfaces, or necessary for the protective separation of different voltages of neighbouring interfaces, or for the protection of cut ends of jumper links.

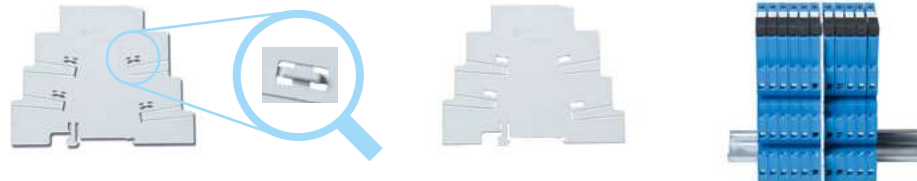

2. Leaving the ribs in place provides 6.2 mm separation. Simply cutting (with scissors) the relevant segment(s) permits the interconnection across the separator of 2 different groups of interface relays, using the standard jumper link.

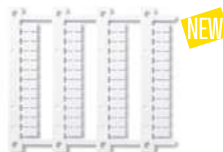
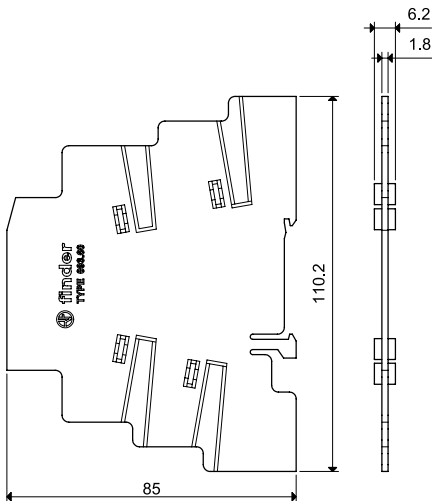

NEW

093.48

Sheet of marker tags, plastic, 48 tags, 6 x 10 mm	093.48
--	--------

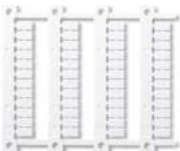

060.48

Sheet of marker tags (CEMBRE Thermal transfer printers), 48 tags, 6 x 12 mm	060.48
--	--------

Accessories



Terminal doubler (for Push-in sockets only)	093.62
Total load	6 A - 300 V
Max. wire size	Solid and stranded cable
	mm ² 2 x 1.5 AWG 2 x 16

B



093.68.14.1

Approvals
(according to type):



MasterADAPTER	093.68.14.1
The MasterADAPTER permits the easy connection of A1/A2 terminals of up to 8 MasterINTERFACE modules to PLC outputs via a 14-Pole ribbon cable, plus simple 2-wire power supply connection ATEX Version.	

Technical data	
Rated current (per signal path)	A 1
Minimum required supply power	W 3
Nominal voltage (U _N)	V DC 24
Operating range	(0.8...1.1)U _N
Control logic	Positive switching (to A1)
Power supply status indication	Green LED
Ambient temperature range	°C -40...+70

Terminals for 24 V control logic	
Type of connector	14 pole, according to IEC 60603-13
ATEX version	II 3G Ex nA IIC Gc

Terminals for 24 V power supply	
Wire strip length	mm 9.5
Screw torque	Nm 0.5
Max. wire size	solid wire
	mm ² 1 x 4 / 2 x 1.5 AWG 1 x 12 / 2 x 16
	stranded wire
	mm ² 1 x 2.5 / 2 x 1.5 AWG 1 x 14 / 2 x 16



Connected **MasterADAPTER**

Wiring diagram

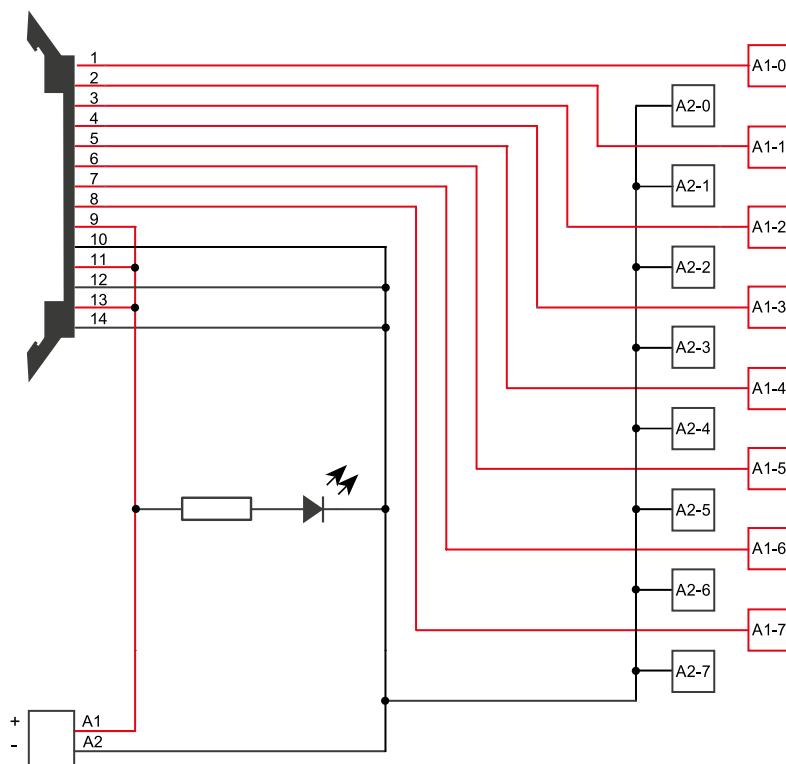



finder[®]
SWITCH TO THE FUTURE

48
SERIES

Relay Interface Modules 8 - 10 - 16 A



Control panels



Carousel
warehouses



Medical and
dentistry



Shipyards



Elevators and
lifts



Panels for electrical
distribution



Building
automation



Hoists and cranes

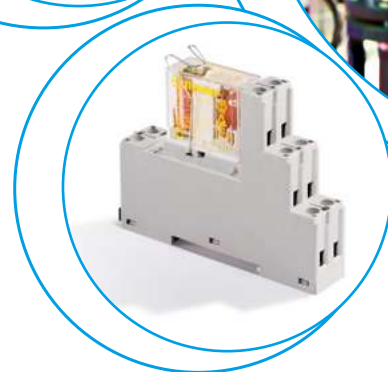
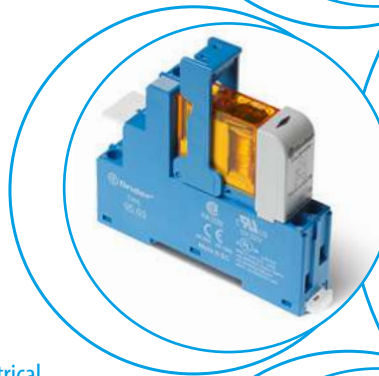

2 CO forcibly guided contacts relay interface modules, 15.8 mm wide

Type 48.12

- 2 CO 8 A
- Screw terminals
- Relay with forcibly guided contacts according to EN 61810-3 Type B (previously EN 50205)
- 35 mm rail (EN 60715) mounting
- Cadmium-free contact material

48.12
Screw terminal



NEW 48.12



- 2 CO 8 A
- Forcibly guided contacts relay
- Screw terminals

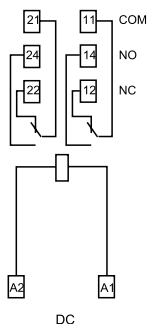

According to EN 61810-3 only 1 NO and 1 NC (11-14 and 21-22 or 11-12 and 21-24) shall be used as forcibly guided contacts.

For outline drawing see page 11

Contact specification

Contact configuration		2 CO (DPDT)
Rated current/Maximum peak current	A	8/15
Rated voltage/Maximum switching voltage	V AC	250/400
Rated load AC1	VA	2000
Rated load AC15 (230 V AC)	VA	500
Single phase motor rating (230 V AC)	kW	0.37
Breaking capacity DC1: 30/110/220 V	A	8/0.65/0.2
Minimum switching load	mW (V/mA)	500 (10/10)
Standard contact material		AgNi+Au

Coil specification

Nominal voltage (U _N)	V AC (50/60 Hz)	—
	V DC	12 - 24
Rated power AC/DC	VA (50 Hz)/W	—/0.7
Operating range	AC	—
	DC	(0.75...1.2)U _N
Holding voltage	AC/DC	—/0.4 U _N
Must drop-out voltage	AC/DC	—/0.1 U _N

Technical data

Mechanical life AC/DC	cycles	—/10 · 10 ⁶
Electrical life at rated load AC1	cycles	100 · 10 ³
Operate/release time	ms	10/4
Insulation between coil and contacts (1.2/50 μs)	kV	6 (8 mm)
Dielectric strength between open contacts	V AC	1500
Ambient temperature range	°C	-40...+70
Protection category		IP 20

Approvals relay (according to type)



B

1 CO relay interface modules,
15.8 mm wide

Ideal interface for PLC and electronic systems

Type 48.P3

- 1 CO 10 A
- Push-in terminals

Type 48.31

- 1 CO 10 A
- Screw terminals

- AC coils or DC sensitive coils
- Supply status indication and EMC coil suppression module as standard
- Identification label
- UL Listing (certain relay/socket combinations)
- 35 mm rail (EN 60715) mounting
- Cadmium-free contact material

48.P3
Push-in terminal



48.31
Screw terminal



48.P3



- 1 CO 10 A
- Push-in terminals

48.31



- 1 CO 10 A
- Screw terminals

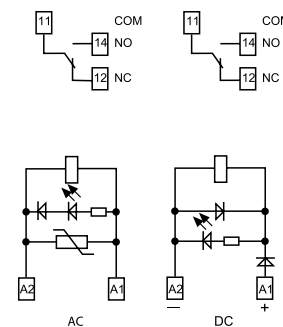
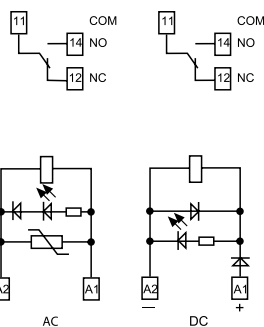

For outline drawing see page 11

Contact specification

Contact configuration		1 CO (SPDT)	1 CO (SPDT)
Rated current/Maximum peak current	A	10/20	10/20
Rated voltage/Maximum switching voltage	V AC	250/400	250/400
Rated load AC1	VA	2500	2500
Rated load AC15 (230 V AC)	VA	500	500
Single phase motor rating (230 V AC)	kW	0.37	0.37
Breaking capacity DC1: 30/110/220 V	A	10/0.3/0.12	10/0.3/0.12
Minimum switching load	mW (V/mA)	300 (5/5)	300 (5/5)
Standard contact material		AgNi	AgNi

Coil specification

Nominal voltage (U _N)	V AC (50/60 Hz)	12 - 24 - 110 - 120 - 230	12 - 24 - 110 - 120 - 230
	V DC	12 - 24 - 125	12 - 24 - 125
Rated power AC/sens. DC	VA (50 Hz)/W	1.2/0.5	1.2/0.5
Operating range	AC	(0.8...1.1)U _N	(0.8...1.1)U _N
	sens. DC	(0.73...1.5)U _N	(0.73...1.5)U _N
Holding voltage	AC/DC	0.8 U _N / 0.4 U _N	0.8 U _N / 0.4 U _N
Must drop-out voltage	AC/DC	0.2 U _N / 0.1 U _N	0.2 U _N / 0.1 U _N

Technical data

Mechanical life	cycles	10 · 10 ⁶	10 · 10 ⁶
Electrical life at rated load AC1	cycles	200 · 10 ³	200 · 10 ³
Operate/release time	ms	7/4 (AC) - 12/12 (DC)	7/4 (AC) - 12/12 (DC)
Insulation between coil and contacts (1.2/50 μs)	kV	6 (8 mm)	6 (8 mm)
Dielectric strength between open contacts	V AC	1000	1000
Ambient temperature range	°C	-40...+70	-40...+70
Protection category		IP 20	IP 20

Approvals relay (according to type)



**2 CO relay interface modules,
15.8 mm wide**
Ideal interface for PLC and electronic systems

Type 48.P5

- 2 CO 8 A
- Push-in terminals

Type 48.52

- 2 CO 8 A
- Screw terminals

- AC coils or DC sensitive coils
- Supply status indication and EMC coil suppression module as standard
- Identification label
- UL Listing (certain relay/socket combinations)
- 35 mm rail (EN 60715) mounting
- Cadmium-free contact material

48.P5

Push-in terminal



48.52

Screw terminal



For outline drawing see page 11

Contact specification

Contact configuration		2 CO (DPDT)	2 CO (DPDT)
Rated current/Maximum peak current	A	8/15	8/15
Rated voltage/ Maximum switching voltage	V AC	250/250	250/250
Rated load AC1	VA	2000	2000
Rated load AC15 (230 V AC)	VA	400	400
Single phase motor rating (230 V AC)	kW	0.3	0.3
Breaking capacity DC1: 30/110/220 V	A	8/0.3/0.12	8/0.3/0.12
Minimum switching load	mW (V/mA)	300 (5/5)	300 (5/5)
Standard contact material		AgNi	AgNi

Coil specification

Nominal voltage (U_N)	V AC (50/60 Hz)	12 - 24 - 110 - 120 - 230	12 - 24 - 110 - 120 - 230
	V DC	12 - 24 - 125	12 - 24 - 125
Rated power AC/sens. DC	VA (50 Hz)/W	1.2/0.5	1.2/0.5
Operating range	AC	$(0.8 \dots 1.1) U_N$	$(0.8 \dots 1.1) U_N$
	sens. DC	$(0.73 \dots 1.5) U_N$	$(0.73 \dots 1.5) U_N$
Holding voltage	AC/DC	$0.8 U_N / 0.4 U_N$	$0.8 U_N / 0.4 U_N$
Must drop-out voltage	AC/DC	$0.2 U_N / 0.1 U_N$	$0.2 U_N / 0.1 U_N$

Technical data

Mechanical life	cycles	$10 \cdot 10^6$	$10 \cdot 10^6$
Electrical life at rated load AC1	cycles	$100 \cdot 10^3$	$100 \cdot 10^3$
Operate/release time	ms	7/4 (AC) - 12/12 (DC)	7/4 (AC) - 12/12 (DC)
Insulation between coil and contacts (1.2/50 μ s)	kV	6 (8 mm)	6 (8 mm)
Dielectric strength between open contacts	V AC	1000	1000
Ambient temperature range	$^{\circ}$ C	-40...+70	-40...+70
Protection category		IP 20	IP 20

Approvals relay (according to type)



- 2 CO 8 A
- Push-in terminals

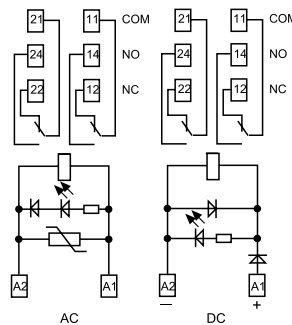

- 2 CO 8 A
- Screw terminals

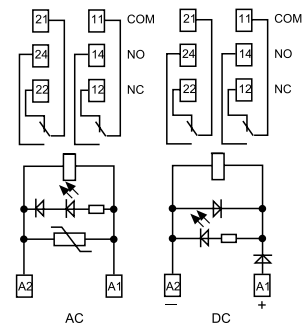

**1 CO relay interface modules,
15.8 mm wide**
Ideal interface for PLC and electronic systems

Type 48.P6

- 1 CO 16 A
- Push-in terminals

Type 48.61

- 1 CO 16 A
- Screw terminals

- AC coils or DC sensitive coils
- Supply status indication and EMC coil suppression module as standard
- Identification label
- UL Listing (certain relay/socket combinations)
- 35 mm rail (EN 60715) mounting
- Cadmium-free contact material available

48.P6
Push-in terminal



48.61
Screw terminal



For outline drawing see page 11

Contact specification

Contact configuration		1 CO (SPDT)
Rated current/Maximum peak current	A	16*/30
Rated voltage/Maximum switching voltage	V AC	250/400
Rated load AC1	VA	4000
Rated load AC15 (230 V AC)	VA	750
Single phase motor rating (230 V AC)	kW	0.55
Breaking capacity DC1: 30/110/220 V	A	16/0.3/0.12
Minimum switching load	mW (V/mA)	500 (10/5)
Standard contact material		AgCdO

Coil specification

Nominal voltage (U _N)	V AC (50/60 Hz)	12 - 24 - 110 - 120 - 230
	V DC	12 - 24 - 125
Rated power AC/sens. DC	VA (50 Hz)/W	1.2/0.5
Operating range	AC	(0.8...1.1)U _N
	sens. DC	(0.8...1.5)U _N
Holding voltage	AC/DC	0.8 U _N / 0.4 U _N
Must drop-out voltage	AC/DC	0.2 U _N / 0.1 U _N

Technical data

Mechanical life	cycles	10 · 10 ⁶
Electrical life at rated load AC1	cycles	100 · 10 ³
Operate/release time	ms	7/4 (AC) - 12/12 (DC)
Insulation between coil and contacts (1.2/50 μs)	kV	6 (8 mm)
Dielectric strength between open contacts	V AC	1000
Ambient temperature range	°C	-40...+70
Protection category		IP 20

Approvals relay (according to type)

48.P6

- 1 CO 16 A
- Push-in terminals

* For currents > 10 A, contact terminals must be connected in parallel (21 with 11, 24 with 14, 22 with 12).

Contact configuration	1 CO (SPDT)
Rated current/Maximum peak current	16*/30
Rated voltage/Maximum switching voltage	250/400
Rated load AC1	4000
Rated load AC15 (230 V AC)	750
Single phase motor rating (230 V AC)	0.55
Breaking capacity DC1: 30/110/220 V	16/0.3/0.12
Minimum switching load	500 (10/5)
Standard contact material	AgCdO
Nominal voltage (U _N)	V AC (50/60 Hz): 12 - 24 - 110 - 120 - 230 V DC: 12 - 24 - 125
Rated power AC/sens. DC	VA (50 Hz)/W: 1.2/0.5
Operating range	AC: (0.8...1.1)U _N sens. DC: (0.8...1.5)U _N
Holding voltage	0.8 U _N / 0.4 U _N
Must drop-out voltage	0.2 U _N / 0.1 U _N
Mechanical life	cycles: 10 · 10 ⁶
Electrical life at rated load AC1	cycles: 100 · 10 ³
Operate/release time	ms: 7/4 (AC) - 12/12 (DC)
Insulation between coil and contacts (1.2/50 μs)	kV: 6 (8 mm)
Dielectric strength between open contacts	V AC: 1000
Ambient temperature range	°C: -40...+70
Protection category	IP 20
Approvals relay (according to type)	CE, EAC, RINA, UL, etc.

48.61

- 1 CO 16 A
- Screw terminals

* For currents > 10 A, contact terminals must be connected in parallel (21 with 11, 24 with 14, 22 with 12).

Contact configuration	1 CO (SPDT)
Rated current/Maximum peak current	16*/30
Rated voltage/Maximum switching voltage	250/400
Rated load AC1	4000
Rated load AC15 (230 V AC)	750
Single phase motor rating (230 V AC)	0.55
Breaking capacity DC1: 30/110/220 V	16/0.3/0.12
Minimum switching load	500 (10/5)
Standard contact material	AgCdO
Nominal voltage (U _N)	V AC (50/60 Hz): 12 - 24 - 110 - 120 - 230 V DC: 12 - 24 - 125
Rated power AC/sens. DC	VA (50 Hz)/W: 1.2/0.5
Operating range	AC: (0.8...1.1)U _N sens. DC: (0.8...1.5)U _N
Holding voltage	0.8 U _N / 0.4 U _N
Must drop-out voltage	0.2 U _N / 0.1 U _N
Mechanical life	cycles: 10 · 10 ⁶
Electrical life at rated load AC1	cycles: 100 · 10 ³
Operate/release time	ms: 7/4 (AC) - 12/12 (DC)
Insulation between coil and contacts (1.2/50 μs)	kV: 6 (8 mm)
Dielectric strength between open contacts	V AC: 1000
Ambient temperature range	°C: -40...+70
Protection category	IP 20
Approvals relay (according to type)	CE, EAC, RINA, UL, etc.

**2 CO relay interface modules,
15.8 mm wide**
Ideal interface for PLC and electronic systems

Type 48.P8

- 2 CO 10 A
- Push-in terminals

Type 48.62

- 2 CO 10 A
- Screw terminals

- DC sensitive coils
- Supply status indication and EMC coil suppression module as standard
- Identification label
- UL Listing (certain relay/socket combinations)
- 35 mm rail (EN 60715) mounting
- Cadmium-free contact material

48.P8
Push-in terminal



48.62
Screw terminal



48.P8



- 2 CO 10 A
- Push-in terminals

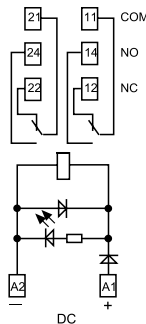

48.62



- 2 CO 10 A
- Screw terminals

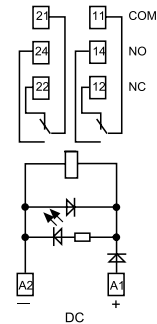

For outline drawing see page 11

Contact specification

Contact configuration		2 CO (DPDT)	2 CO (DPDT)
Rated current/Maximum peak current	A	10/20	10/20
Rated voltage/ Maximum switching voltage	V AC	250/400	250/400
Rated load AC1	VA	2500	2500
Rated load AC15 (230 V AC)	VA	500	500
Single phase motor rating (230 V AC)	kW	0.37	0.37
Breaking capacity DC1: 30/110/220 V	A	10/0.3/0.12	10/0.3/0.12
Minimum switching load	mW (V/mA)	300 (5/5)	300 (5/5)
Standard contact material		AgNi	AgNi

Coil specification

Nominal voltage (U _N)	V AC (50/60 Hz)	—	—
	V DC	12 - 24 - 125	12 - 24 - 125
Rated power AC/sens. DC	VA (50 Hz)/W	—/0.5	—/0.5
Operating range	AC	—	—
	sens. DC	(0.8...1.5)U _N	(0.8...1.5)U _N
Holding voltage	AC/DC	—/0.4 U _N	—/0.4 U _N
Must drop-out voltage	AC/DC	—/0.1 U _N	—/0.1 U _N

Technical data

Mechanical life	cycles	20 · 10 ⁶	20 · 10 ⁶
Electrical life at rated load AC1	cycles	100 · 10 ³	100 · 10 ³
Operate/release time	ms	12/12 (DC)	12/12 (DC)
Insulation between coil and contacts (1.2/50 µs)	kV	6 (8 mm)	6 (8 mm)
Dielectric strength between open contacts	V AC	1000	1000
Ambient temperature range	°C	-40...+70	-40...+70
Protection category		IP 20	IP 20

Approvals relay (according to type)



Ordering information

Example: 48 series, 35 mm rail (EN 60715) mount, Push-in terminal relay interface module, 2 CO 8 A contacts, 24 V sensitive DC coil, green LED + diode, 99.02 coil indication.

B

4 8 . P 5 . 7 . 0 2 4 . 0 0 5 0

Series

Type

Screw terminal

- 1 = 35 mm rail (EN 60715) mount, forcibly guided contacts relay
- 3 = 35 mm rail (EN 60715) mount
- 5 = 35 mm rail (EN 60715) mount
- 6 = 35 mm rail (EN 60715) mount

Push-in terminal

- P = 35 mm rail (EN 60715) mount

Type

Screw terminal

- 1 = for 48.31, 1 pole, 10 A
48.61, 1 pole, 16 A
- 2 = for 48.12 (DC only), 48.52, 2 poles, 8 A
48.62 (DC only), 2 poles, 10 A

Push-in terminal

- 3 = for 48.P3, 1 pole, 10 A
- 5 = for 48.P5, 2 pole, 8 A
- 6 = for 48.P6, 1 pole, 16 A
- 8 = for 48.P8 (DC only), 2 pole, 10 A

Coil version

- 7 = Sensitive DC
- 8 = AC (50/60 Hz)
- 9 = DC (for 48.12 only)

Coil voltage

See coil specifications

Technical data

A: Contact material

- 0 = Standard AgNi for 48.P3/P5/P8/31/52/62 AgCdO, Standard for 48.P6/61
- 4 = AgSnO₂, for 48.P6/P8/61/62 only
- 5 = AgNi + Au, for 48.12 and 48.P3/P5/31/52 only

B: Contact circuit

- 0 = CO (nPDT)

D: Special versions

- 0 = Standard
- 7 = Standard (for 48.12 only)

C: Options

- 0 = Standard (for 48.12 only)
- 5 = Standard for DC: green LED + diode (polarity +A1)
- 6 = Standard for AC: green LED + Varistor

Selecting features and options: only combinations in the same row are possible.
Preferred selections for best availability are shown in **bold**.

Type	Coil version	A	B	C	D
48.12	DC	5	0	0	7
48.P3/P5/31/52	AC	0 - 5	0	6	0
48.P3/P5/31/52	Sensitive DC	0 - 5	0	5	0
48.P6/61	AC	0 - 4	0	6	0
48.P6/61	Sensitive DC	0 - 4	0	5	0
48.P8/62	Sensitive DC	0 - 4	0	5	0

Insulation		48.12/31/61/P3/P6	48.52/P5	48.12/31/61/62/P3/P6/P8	
Insulation according to EN 61810-1	insulation rated voltage	V 250	250	400	
	rated impulse withstand voltage	kV 4	4	4	
	pollution degree	3	2	2	
	overvoltage category	III	III	III	
Insulation between coil and contacts (1.2/50 μs)		kV 6 (8 mm)			
Dielectric strength between open contacts		V AC 1000; 1500 (48.12)			
Dielectric strength between adjacent contacts		V AC 2000 (48.P5/52); 2500 (48.12/P6)			
Insulation between coil terminals					
Rated impulse voltage (surge) differential mode (according to EN 61000-4-5)		kV(1.2/50 μs) 2			
Other data					
Bounce time: NO/NC		ms 2/5; 2/10 (48.12)			
Vibration resistance (10...200)Hz: NO/NC		g 20/5 (for 1 pole)		15/3; 20/6 (48.12) for 2 pole	
Power lost to the environment	without contact current	W 0.7			
	with rated current	W 1.2 (48.12/31/P3)	1.3 (48.52/P5)	1.2 (48.61/62/P6/P8)	
Wire strip length		mm 8			
 Screw torque (only for 48.12/31/52/61/81)		Nm 0.5			
Min. wire size	Screw terminal		Push-in terminal		
		solid cable	stranded cable	solid cable	stranded cable
	mm ²	0.5	0.5	0.5	0.5
	AWG	21	21	21	21
Max. wire size	Screw terminal		Push-in terminal		
		solid cable	stranded cable	solid cable	stranded cable
	mm ²	1 x 6 / 2 x 2.5	1 x 4 / 2 x 2.5	2 x 1.5 / 1 x 2.5	2 x 1.5 / 1 x 2.5
	AWG	1 x 10 / 2 x 14	1 x 12 / 2 x 14	2 x 16 / 1 x 14	2 x 16 / 1 x 14

B

Contact specification

F 48 - Electrical life (AC) v contact current
Types 48.P3/P6/31/61

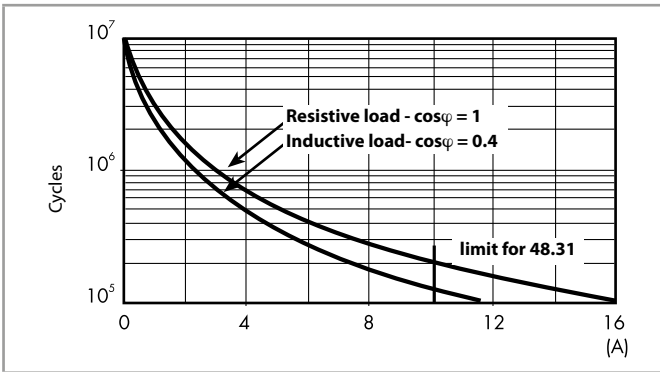

F 48 - Electrical life (AC) v contact current
Types 48.P8/62

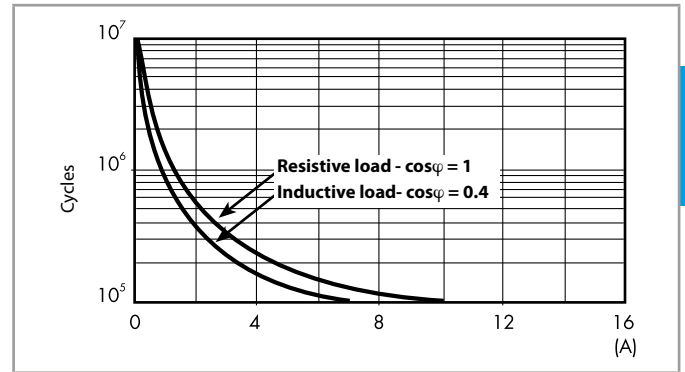

F 48 - Electrical life (AC) v contact current
Types 48.P5/52

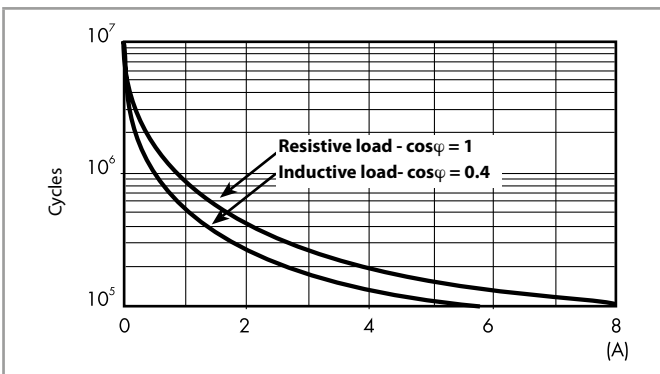

F 48 - Electrical life (AC) v contact current
Type 48.12

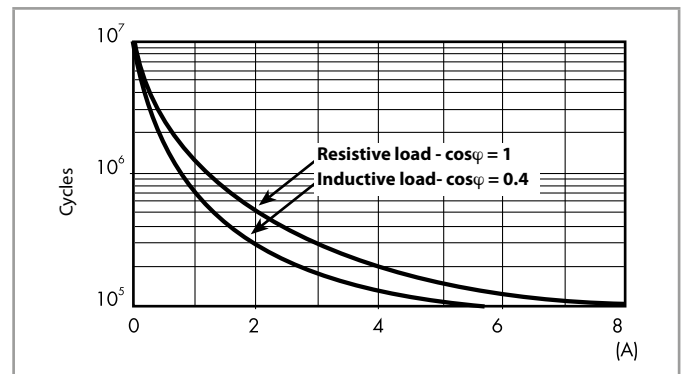

H 48 - Maximum DC1 breaking capacity
Types 48.P3/P5/P6/31/52/61

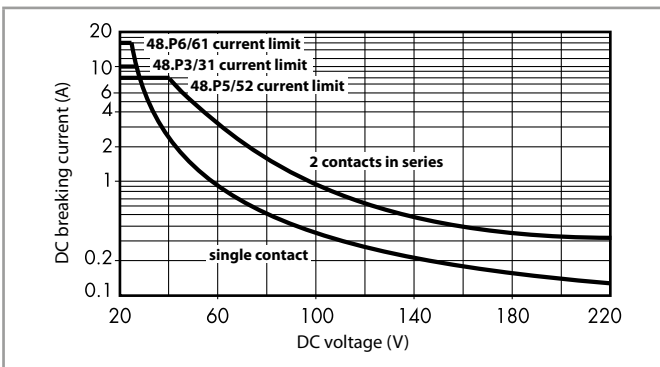

H 48 - Maximum DC1 breaking capacity
Types 48.P8/62

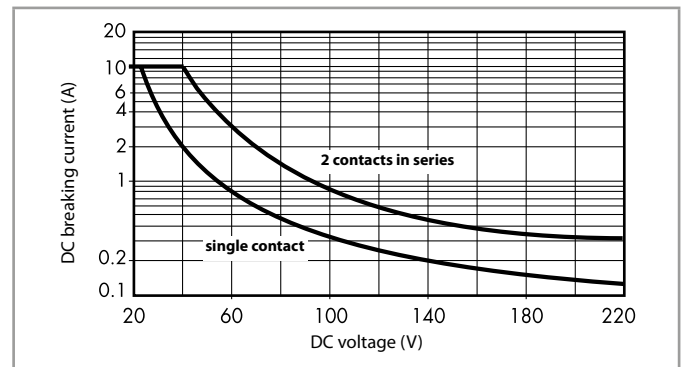

H 48 - Maximum DC1 breaking capacity
Type 48.12

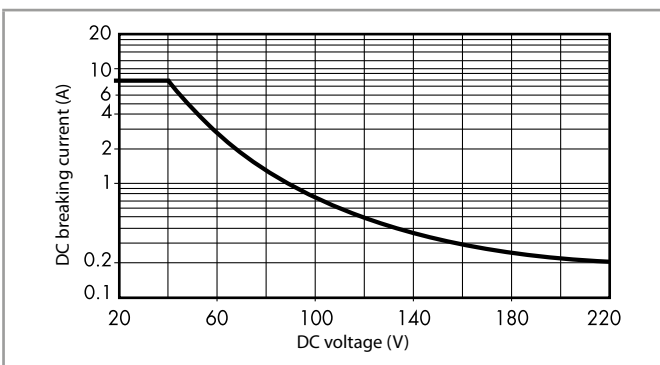

- When switching a resistive load (DC1) having voltage and current values under the curve, an electrical life of $\geq 100 \cdot 10^3$ can be expected.
- In the case of DC13 loads, the connection of a diode in parallel with the load will permit a similar electrical life as for a DC1 load.
Note: the release time for the load will be increased.

Coil specifications

DC coil data (0.5 W sensitive)

Nominal voltage U_N	Coil code	Operating range		Rated coil consumption I at U_N
		U_{min}^*	U_{max}	
V		V	V	mA
12	7.012	8.8	18	41
24	7.024	17.5	36	22.2
125	7.125	91	188	4

* $U_{min} = 0.8 U_N$ for 48.61, 48.62, 48.P6, 48.P8

AC coil data

Nominal voltage U_N	Coil code	Operating range		Rated coil consumption I at U_N (50 Hz)
		U_{min}	U_{max}	
V		V	V	mA
12	8.012	9.6	13.2	90.5
24	8.024	19.2	26.4	46
110	8.110	88	121	10.1
120	8.120	96	132	11.8
230	8.230	184	253	7.0

DC coil data, 2 pole relay - Type 48.12

Nominal voltage U_N	Coil code	Operating range		Resistance R	Rated coil consumption I at U_N
		U_{min}	U_{max}		
V		V	V	Ω	mA
12	9.012	9	14.4	205	58.5
24	9.024	18	28.8	820	29.3

R 48 - DC coil operating range v ambient temperature

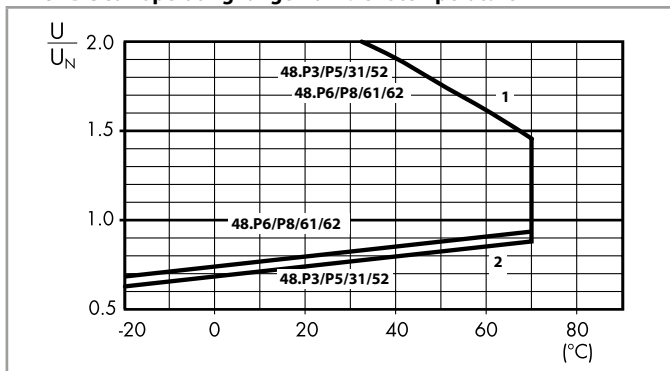

- 1 - Max. permitted coil voltage.
- 2 - Min. pick-up voltage with coil at ambient temperature.

R 48 - AC coil operating range v ambient temperature

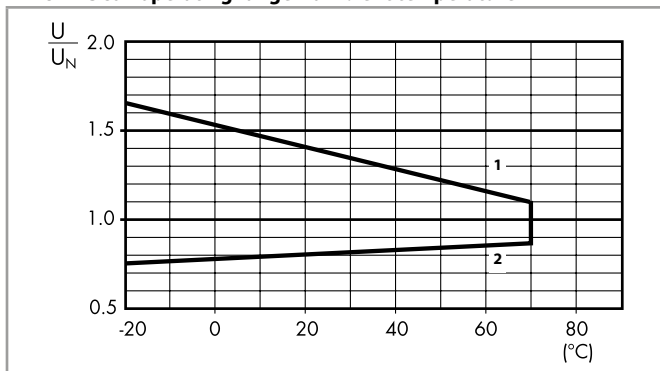

- 1 - Max. permitted coil voltage.
- 2 - Min. pick-up voltage with coil at ambient temperature.

R 48 - DC coil operating range v ambient temperature

Type 48.12

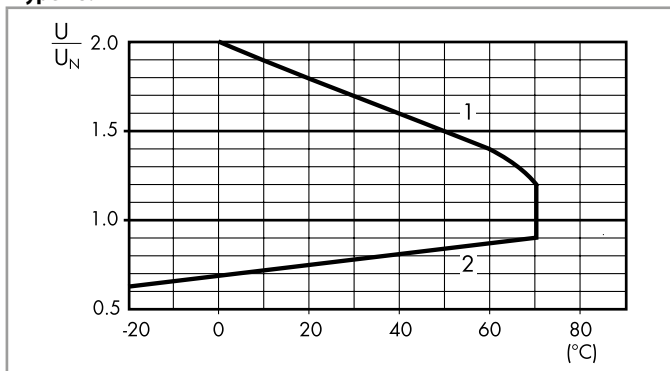

- 1 - Max. permitted coil voltage.
- 2 - Min. pick-up voltage with coil at ambient temperature.

Combinations

Code	Type of socket	Type of relay	Module	Retaining clip
48.12	95.05.7	50.12	—	095.71
48.31	95.03	40.31	99.02	095.01
48.52	95.05	40.52	99.02	095.01
48.61	95.05	40.61	99.02	095.01
48.62	95.05	44.62	99.02	095.01
48.P3	95.P3	40.31	99.02	095.91.3
48.P5	95.P5	40.52	99.02	095.91.3
48.P6	95.P5	40.61	99.02	095.91.3
48.P8	95.P5	44.62	99.02	095.91.3

B

Outline drawing

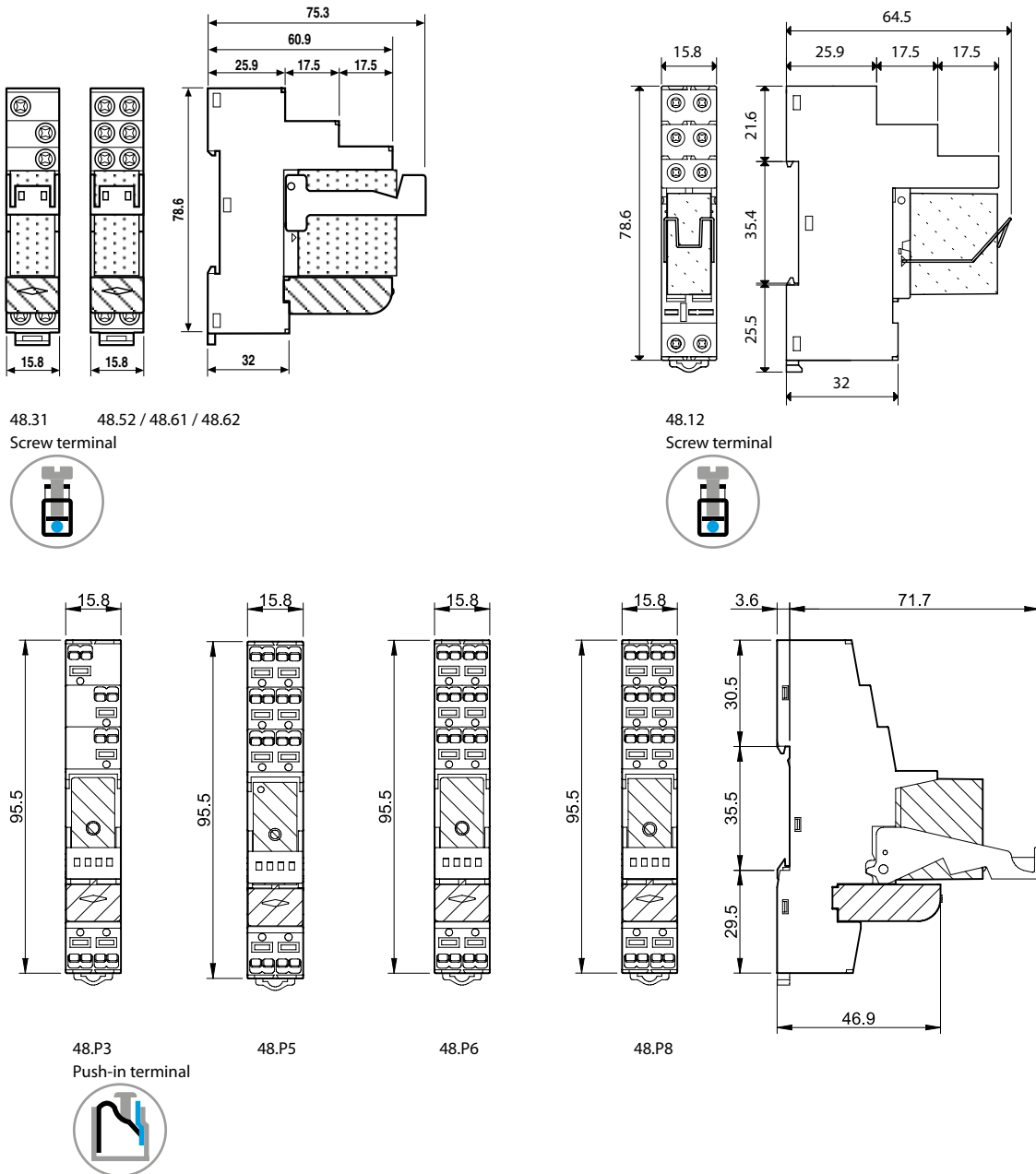

Accessories



097.58

8-way jumper link for type 48.P3/P5/P6/P8	097.58
Rated values	10 A - 250 V

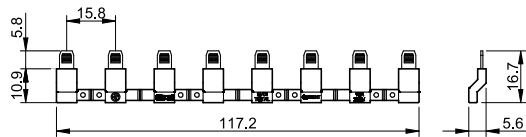

2-way jumper link for type 48.P3/P5/P6/P8	097.52
Rated values	10 A - 250 V

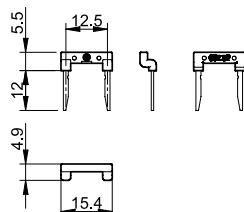

097.52

2-way jumper link for type 48.P3/P5/P6/P8	097.42
Rated values	10 A - 250 V

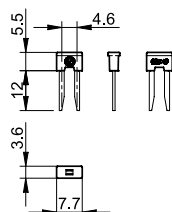

097.42

Marker tag holder for type 48.P3/P5/P6/P8 and 48.12/31/52/61/62	097.00
--	--------

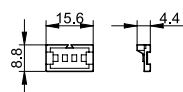

097.00

8-way jumper link for screw terminal version	095.18 (blue)	095.18.0 (black)
Rated values	10 A - 250 V	

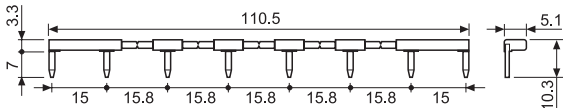

095.18



Sheet of marker tags (CEMBRE Thermal transfer printers) , plastic, 48 tags, 6 x 12 mm	060.48
--	--------

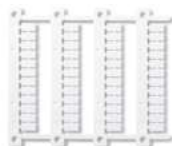

060.48

Packaging codes

How to code and identify retaining clip and packaging options for sockets.

Example:

4 8 . P 5 . 7 . 0 2 4 . 0 0 5 0 S P A

A Standard packaging
B Blister packaging

SP Plastic retaining clip



finder[®]
SWITCH TO THE FUTURE

4C
SERIES

Relay interface modules 8 - 10 - 16 A



Escalators



Road / tunnel
lighting



Hoists and
cranes



Carousel
warehouses



Control panels



Panels for electrical
distribution

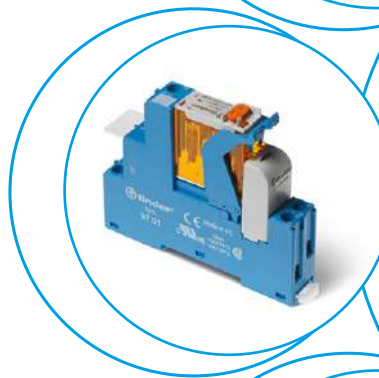

**1 & 2 CO relay interface modules,
15.8 mm wide with Push-in terminal**
Ideal interface for PLC and electronic systems

Type 4C.P1

- 1 CO 10 A

Type 4C.P2

- 2 CO 8 A

- AC coils or DC coils
- Supply status indication and coil suppression module as standard
- Identification label
- UL Listing (certain relay/socket combinations)
- 35 mm rail (EN 60715) mounting

4C.P1 / 4C.P2
Push-in terminals



- 1 CO 10 A
- Push-in terminals



- 2 CO 8 A
- Push-in terminals

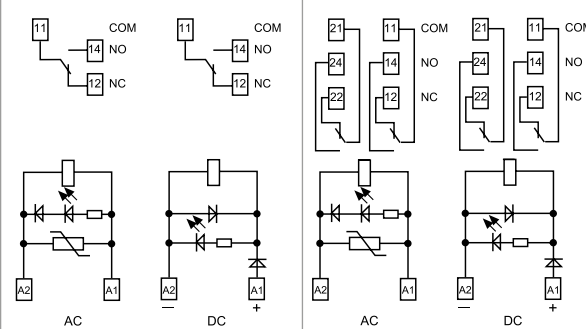

For outline drawing see page 7

Contact specification

Contact configuration		1 CO (SPDT)	2 CO (DPDT)
Rated current/Maximum peak current	A	10/25	8/15
Rated voltage/ Maximum switching voltage	V AC	250/440	250/440
Rated load AC1	VA	2500	2000
Rated load AC15 (230 V AC)	VA	750	350
Single phase motor rating (230 V AC)	kW	0.55	0.37
Breaking capacity DC1: 30/110/220 V	A	10/0.5/0.15	6/0.5/0.15
Minimum switching load	mW (V/mA)	300 (5/5)	300 (5/5)
Standard contact material		AgNi	AgNi

Coil specification

Nominal voltage (U_N)	V AC (50/60 Hz)	12 - 24 - 110 - 120 - 230	12 - 24 - 110 - 120 - 230
	V DC	12 - 24 - 125	12 - 24 - 125
Rated power AC/DC	VA (50 Hz)/W	1.2/0.5	1.2/0.5
Operating range	AC	$(0.8 \dots 1.1) U_N$	$(0.8 \dots 1.1) U_N$
	DC	$(0.73 \dots 1.1) U_N$	$(0.73 \dots 1.1) U_N$
Holding voltage	AC/DC	$0.8 U_N / 0.4 U_N$	$0.8 U_N / 0.4 U_N$
Must drop-out voltage	AC/DC	$0.2 U_N / 0.1 U_N$	$0.2 U_N / 0.1 U_N$

Technical data

Mechanical life AC/DC	cycles	$10 \cdot 10^6$	$10 \cdot 10^6$
Electrical life at rated load AC1	cycles	$100 \cdot 10^3$	$100 \cdot 10^3$
Operate/release time	ms	15/5 (AC) - 15/12 (DC)	10/3 (AC) - 10/10 (DC)
Insulation between coil and contacts (1.2/50 μ s)	kV	6 (8 mm)	6 (8 mm)
Dielectric strength between open contacts	V AC	1000	1000
Ambient temperature range	$^{\circ}$ C	-40...+70	-40...+70
Protection category		IP 20	IP 20

Approvals relay (according to type)



B

**1 & 2 CO relay interface modules,
15.8 mm wide with screw terminal**

Ideal interface for PLC and electronic systems

Type 4C.01

- 1 CO 16 A

Type 4C.02

- 2 CO 8 A

- AC coils or DC coils
- Supply status indication and coil suppression module as standard
- Identification label
- UL Listing (certain relay/socket combinations)
- 35 mm rail (EN 60715) mounting

4C.01 / 4C.02

Screw terminals



For outline drawing see page 7

Contact specification

Contact configuration		1 CO (SPDT)	2 CO (DPDT)
Rated current/Maximum peak current	A	16/25	8/15
Rated voltage/ Maximum switching voltage	V AC	250/440	250/440
Rated load AC1	VA	4000	2000
Rated load AC15 (230 V AC)	VA	750	350
Single phase motor rating (230 V AC)	kW	0.55	0.37
Breaking capacity DC1: 30/110/220 V	A	16/0.5/0.15	6/0.5/0.15
Minimum switching load	mW (V/mA)	300 (5/5)	300 (5/5)
Standard contact material		AgNi	AgNi

Coil specification

Nominal voltage (U _N)	V AC (50/60 Hz)	12 - 24 - 110 - 120 - 230	12 - 24 - 110 - 120 - 230
	V DC	12 - 24 - 125	12 - 24 - 125
Rated power AC/DC	VA (50 Hz)/W	1.2/0.5	1.2/0.5
Operating range	AC	(0.8...1.1)U _N	(0.8...1.1)U _N
	DC	(0.73...1.1)U _N	(0.73...1.1)U _N
Holding voltage	AC/DC	0.8 U _N / 0.4 U _N	0.8 U _N / 0.4 U _N
Must drop-out voltage	AC/DC	0.2 U _N / 0.1 U _N	0.2 U _N / 0.1 U _N

Technical data

Mechanical life AC/DC	cycles	10 · 10 ⁶	10 · 10 ⁶
Electrical life at rated load AC1	cycles	100 · 10 ³	100 · 10 ³
Operate/release time	ms	15/5 (AC) - 15/12 (DC)	10/3 (AC) - 10/10 (DC)
Insulation between coil and contacts (1.2/50 μs)	kV	6 (8 mm)	6 (8 mm)
Dielectric strength between open contacts	V AC	1000	1000
Ambient temperature range	°C	≤ 12 A: -40...+70 / >12 A: -40...+50	-40...+70
Protection category		IP 20	IP 20

Approvals relay (according to type)



4C.01



- 1 CO 16 A
- Screw terminals

4C.02



- 2 CO 8 A
- Screw terminals

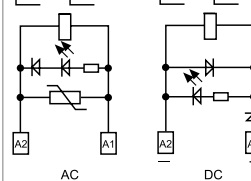
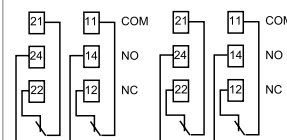
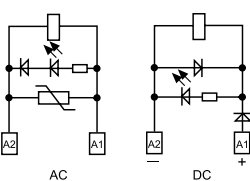

Ordering information

Example: 4C series, 35 mm rail (EN 60715) mount, Push-in terminal relay interface module, 1 CO 10 A contacts, 24 V DC coil, green LED + diode.

	4 C . P	1 . 9 . 0 2 4 . 0	A	B	C	D
<p>Series ———</p> <p>Type ——— 0 = 35 mm rail (EN 60715) mount screw terminal socket P = 35 mm rail (EN 60715) mount Push-in terminal socket</p> <p>No. of poles ——— 1 = 1 pole, 10/16 A 2 = 2 pole, 8 A</p> <p>Coil version ——— 8 = AC (50/60 Hz) 9 = DC</p> <p>Coil voltage ——— See coil specifications</p>		<p>A: Contact material 0 = AgNi 4 = AgSnO₂ 5 = AgNi + Au</p> <p>B: Contact circuit 0 = CO (nPDT)</p>			<p>D: Special versions 0 = Standard</p> <p>C: Options 5 = Standard for DC: green LED + diode (polarity +A1) 6 = Standard for AC: green LED + Varistor</p>	

Selecting features and options: only combinations in the same row are possible.
Preferred selections for best availability are shown in **bold**.

Type	Coil version	A	B	C	D
4C.02	AC	0 - 5	0	6	0
4C.P2	DC	0 - 5	0	5	0
4C.01	AC	0 - 4 - 5	0	6	0
4C.P1	DC	0 - 4 - 5	0	5	0

Technical data

Insulation

Insulation according to EN 61810-1	insulation rated voltage	V	250	440
	rated impulse withstand voltage	kV	4	4
	pollution degree		3	2
	overvoltage category		III	III
Insulation between coil and contacts (1.2/50 µs)	kV	6 (8 mm)		
Dielectric strength between open contacts	V AC	1000		
Dielectric strength between adjacent contacts	V AC	2000		

Conducted disturbance immunity

Burst (5...50)ns, 5 kHz, on A1 - A2 according to EN 61000-4-4	level 4 (4 kV)
Surge (1.2/50 µs) on A1 - A2 (differential mode) according to EN 61000-4-5	level 3 (2 kV)

Other data

Bounce time: NO/NC	ms	2/6 (4C.01/P1)	1/4 (4C.02/P2)
Vibration resistance (10...150)Hz: NO/NC	g	20/12	
Power lost to the environment	without contact current	W	0.6
	with rated current	W	1.6 (4C.01/P1) 2 (4C.02/P2)

Terminals

Wire strip length	mm	4C.01/4C.02		4C.P1/4C.P2	
Screw torque	Nm	0.8			
	Min. wire size	solid cable	stranded cable	solid cable	stranded cable
		mm ²	0.5	0.5	0.5
AWG	21	21	21	21	
Max. wire size	solid cable	stranded cable	solid cable	stranded cable	
	mm ²	1 x 6 / 2 x 2.5	1 x 4 / 2 x 2.5	2 x 1.5 / 1 x 2.5	2 x 1.5 / 1 x 2.5
	AWG	1 x 10 / 2 x 14	1 x 12 / 2 x 14	2 x 16 / 1 x 14	2 x 16 / 1 x 14



Contact specification

F 4C - Electrical life (AC) v contact current

Types 4C.02/P2

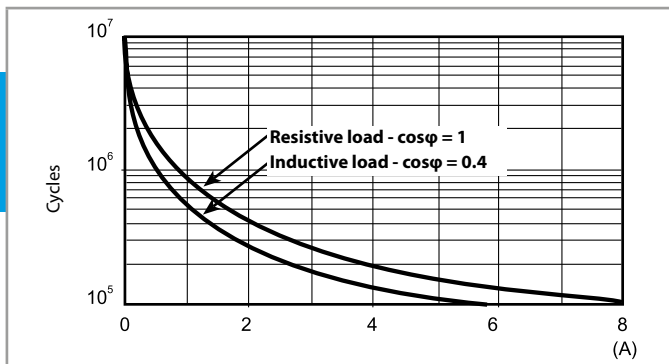

F 4C - Electrical life (AC) v contact current

Types 4C.01/P1

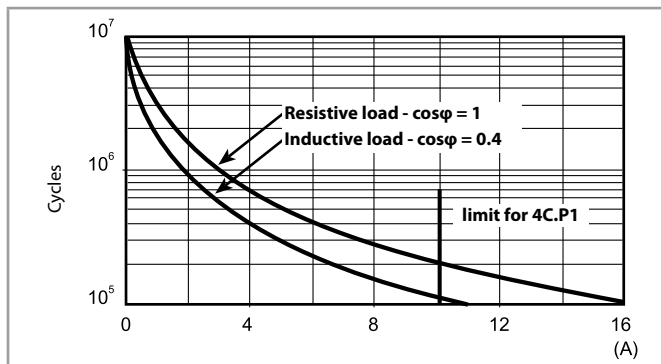

H 4C - Maximum DC1 breaking capacity

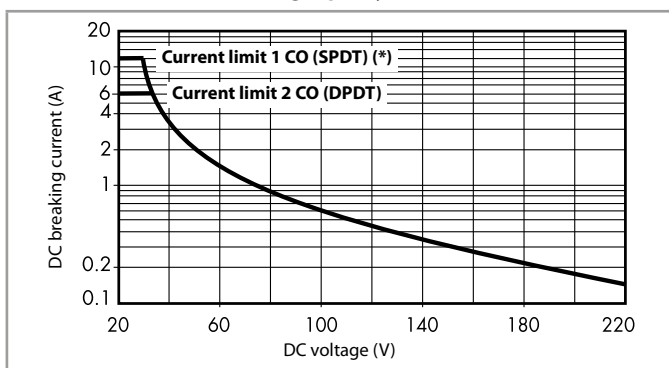

(*) Type 4C.01 = 12 A, Type 4C.P1 = 10 A

- When switching a resistive load (DC1) having voltage and current values under the curve, an electrical life of $\geq 100 \cdot 10^3$ can be expected.
- In the case of DC13 loads, the connection of a diode in parallel with the load will permit a similar electrical life as for a DC1 load. Note: the release time for the load will be increased.

Coil specifications

DC coil data

Nominal voltage U_N	Coil code	Operating range		Resistance R	Rated coil consumption I at U_N
		U_{min}	U_{max}		
V		V	V	Ω	mA
12	9.012	8.8	13.2	300	40
24	9.024	17.5	26.4	1200	20
125	9.125	91.2	138	32000	3.9

AC coil data

Nominal voltage U_N	Coil code	Operating range		Resistance R	Rated coil consumption I at U_N
		U_{min}	U_{max}		
V		V	V	Ω	mA
12	8.012	9.6	13.2	80	90
24	8.024	19.2	26.4	320	45
110	8.110	88	121	6900	9.4
120	8.120	96	132	9000	8.4
230	8.230	184	253	28000	5

R 4C - DC coil operating range v ambient temperature

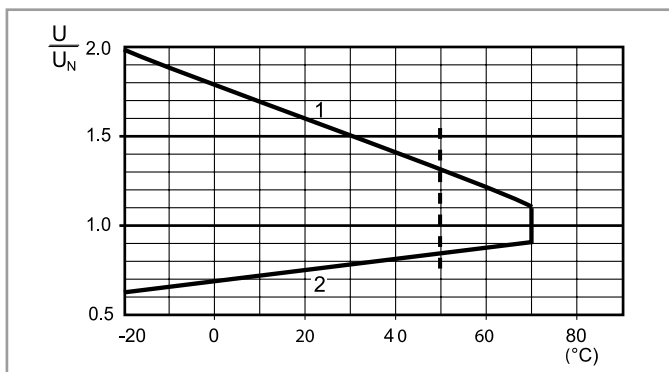

R 4C - AC coil operating range v ambient temperature

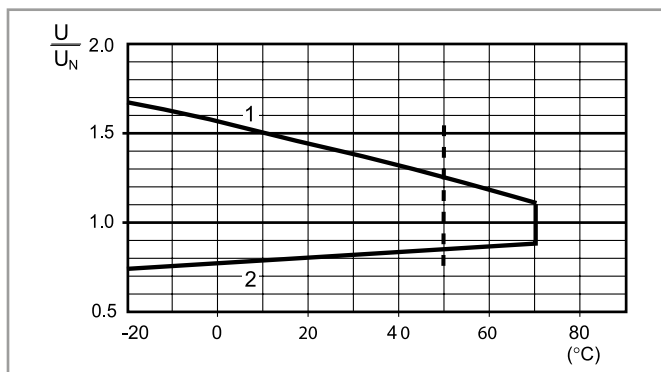

1 - Max. permitted coil voltage.

2 - Min. pick-up voltage with coil at ambient temperature.

1 - Max. permitted coil voltage.

2 - Min. pick-up voltage with coil at ambient temperature.

----- Temperature limit for 4C.01 with 16 A contact current.

Combinations

Code	Type of socket	Type of relay	Module	Retaining clip
4C.P1	97.P1	46.61	99.02	097.01
4C.P2	97.P2	46.52	99.02	097.01
4C.01	97.01	46.61	99.02	097.01
4C.02	97.02	46.52	99.02	097.01

Certain relay/socket combinations

Outline drawing

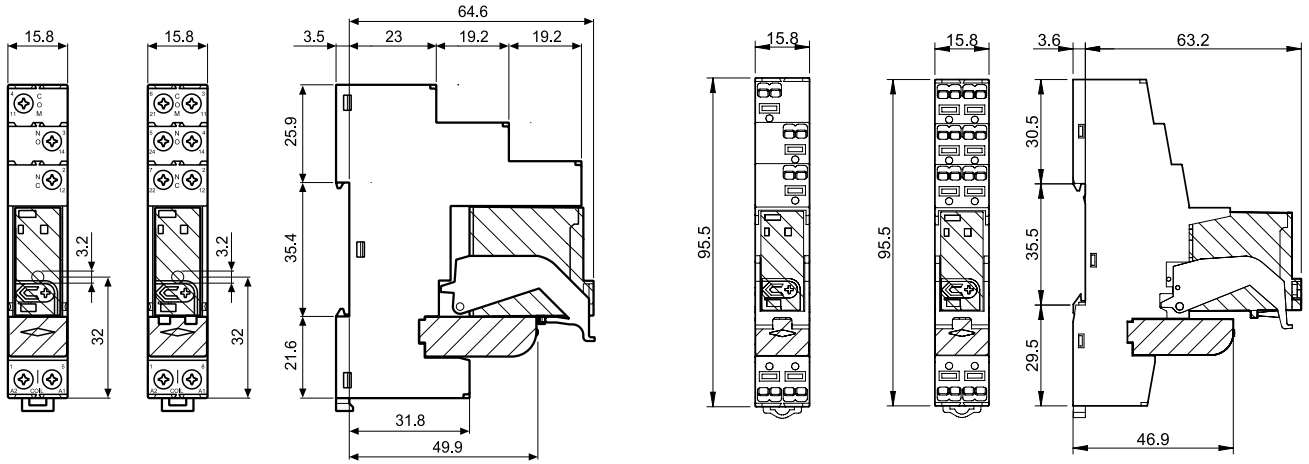

4C.01 / 4C.02
Screw terminals



4C.P1 / 4C.P2
Push-in terminals



Accessories



097.58

8-way jumper link for type 4C.P1 and 4C.P2	097.58
Rated values	10 A - 250 V

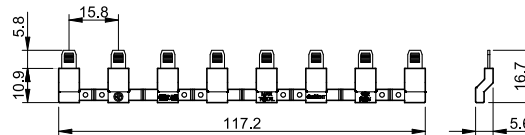

097.52

2-way jumper link for type 4C.P1 and 4C.P2	097.52
Rated values	10 A - 250 V

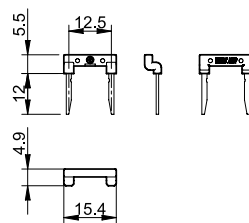

097.42

2-way jumper link for type 4C.P1 and 4C.P2	097.42
Rated values	10 A - 250 V

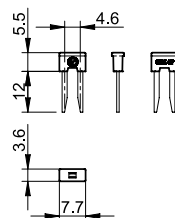

Accessories



097.00

Marker tag holder for type 4C.P1/P2/01/02	097.00
---	--------

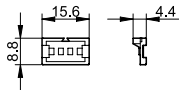

8-way jumper link for 4C.01 and 4C.02	095.18 (blue)
---------------------------------------	---------------

Rated values	10 A - 250 V
--------------	--------------

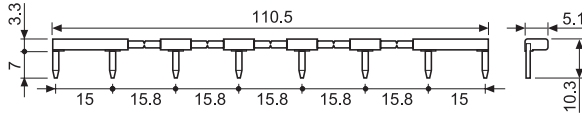

Sheet of marker tags (CEMBRE Thermal transfer printers), marker tag holder 097.00 or on the relay 46 series, plastic, 48 tags, 6 x 12 mm	060.48
--	--------

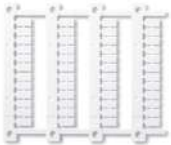

060.48



B

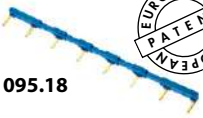

095.18

Packaging codes

How to code and identify retaining clip and packaging options for relay interface module.

Example:

4 C . P 1 . 9 . 0 2 4 . 0 0 5 0 S P A

A Standard packaging
B Blister packaging

SP Plastic retaining clip



finder[®]
SWITCH TO THE FUTURE

58
SERIES

Relay interface modules 6 - 7 - 10 A



Control panels



Packaging machines



Shipyards



Textile machines



Carousel warehouses



Panels for electrical distribution



Hoists and cranes



Wood-processing machines

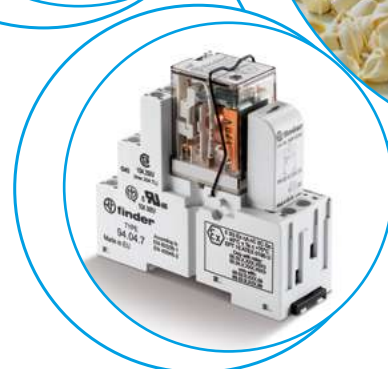
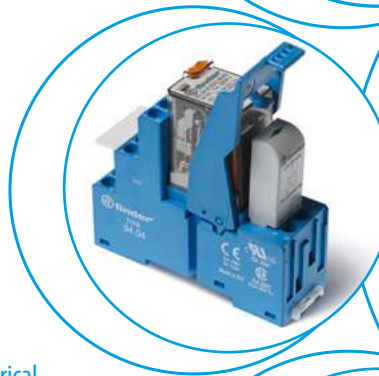

**3 & 4 CO relay interface modules,
31 mm wide with Push-in terminals**
Ideal interface for PLC and electronic systems

Type 58.P3

- 3 CO 10 A
- Push-in terminals

Type 58.P4

- 4 CO 7 A
- Push-in terminals

- AC coils or DC coils
- Supply status indication and EMC coil suppression module as standard
- Identification label
- Cadmium Free contacts
- UL Listing (certain relay/socket combinations)
- 35 mm rail (EN 60715) mounting

58.P3 / 58.P4
Push-in terminals



For outline drawing see page 9

Contact specification

Contact configuration		3 CO (3PDT)	4 CO (4PDT)
Rated current/Maximum peak current	A	10/20	7/15
Rated voltage/ Maximum switching voltage	V AC	250/400	250/250
Rated load AC1	VA	2500	1750
Rated load AC15 (230 V AC)	VA	500	350
Single phase motor rating (230 V AC)	kW	0.37	0.125
Breaking capacity DC1: 30/110/220 V	A	10/0.25/0.12	7/0.25/0.12
Minimum switching load	mW (V/mA)	300 (5/5)	300 (5/5)
Standard contact material		AgNi	AgNi

Coil specification

Nominal voltage (U _N)	V AC (50/60 Hz)	12 - 24 - 48 - 110 - 120 - 230	12 - 24 - 48 - 110 - 120 - 230
	V DC	12 - 24 - 48 - 125	12 - 24 - 48 - 125
Rated power AC/DC	VA (50 Hz)/W	1.5/1	1.5/1
Operating range	AC	(0.8...1.1)U _N	(0.8...1.1)U _N
	DC	(0.8...1.1)U _N	(0.8...1.1)U _N
Holding voltage	AC/DC	0.8 U _N / 0.5 U _N	0.8 U _N / 0.5 U _N
Must drop-out voltage	AC/DC	0.2 U _N / 0.1 U _N	0.2 U _N / 0.1 U _N

Technical data

Mechanical life AC/DC	cycles	20 · 10 ⁶ / 50 · 10 ⁶	20 · 10 ⁶ / 50 · 10 ⁶
Electrical life at rated load AC1	cycles	200 · 10 ³	150 · 10 ³
Operate/release time	ms	10/5 (AC) - 10/15 (DC)	11/3 (AC) - 11/15 (DC)
Insulation between coil and contacts (1.2/50 μs)	kV	3.6	3.6
Dielectric strength between open contacts	V AC	1000	1000
Ambient temperature range	°C	-40...+70	-40...+70
Protection category		IP 20	IP 20

Approvals relay (according to type)

NEW 58.P3



- 3 CO 10 A
- Push-in terminals

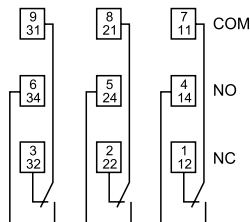

Example: AC

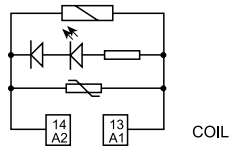

NEW 58.P4



- 4 CO 7 A
- Push-in terminals

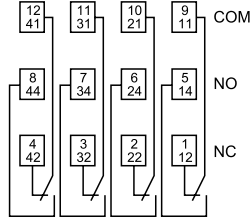

Example: DC

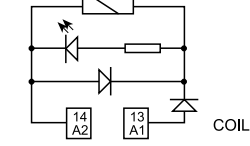

**2, 3 & 4 CO relay interface modules,
27 mm wide with Screw terminals**
Ideal interface for PLC and electronic systems

Type 58.32

- 2 CO 10 A
- Screw terminals

Type 58.33

- 3 CO 10 A
- Screw terminals

Type 58.34

- 4 CO 7 A
- Screw terminals

- AC coils or DC coils
- Supply status indication and EMC coil suppression module as standard
- Identification label
- Cadmium Free contacts
- UL Listing (certain relay/socket combinations)
- 35 mm rail (EN 60715) mounting

58.32 / 58.33 / 58.34
Screw terminals



For outline drawing see page 9

Contact specification

Contact configuration		2 CO (DPDT)	3 CO (3PDT)	4 CO (4PDT)
Rated current/Maximum peak current	A	10/20	10/20	7/15
Rated voltage/ Maximum switching voltage	V AC	250/400	250/400	250/250
Rated load AC1	VA	2500	2500	1750
Rated load AC15 (230 V AC)	VA	500	500	350
Single phase motor rating (230 V AC)	kW	0.37	0.37	0.125
Breaking capacity DC1: 30/110/220 V	A	10/0.25/0.12	10/0.25/0.12	7/0.25/0.12
Minimum switching load	mW (V/mA)	300 (5/5)	300 (5/5)	300 (5/5)
Standard contact material		AgNi	AgNi	AgNi

Coil specification

Nominal voltage (U _N)	V AC (50/60 Hz)	12 - 24 - 48 - 110 - 120 - 230	12 - 24 - 48 - 110 - 120 - 230	12 - 24 - 48 - 110 - 120 - 230
	V DC	12 - 24 - 48 - 125	12 - 24 - 48 - 125	12 - 24 - 48 - 125
Rated power AC/DC	VA (50 Hz)/W	1.5/1	1.5/1	1.5/1
Operating range	AC	(0.8...1.1)U _N	(0.8...1.1)U _N	(0.8...1.1)U _N
	DC	(0.8...1.1)U _N	(0.8...1.1)U _N	(0.8...1.1)U _N
Holding voltage	AC/DC	0.8 U _N / 0.5 U _N	0.8 U _N / 0.5 U _N	0.8 U _N / 0.5 U _N
Must drop-out voltage	AC/DC	0.2 U _N / 0.1 U _N	0.2 U _N / 0.1 U _N	0.2 U _N / 0.1 U _N

Technical data

Mechanical life AC/DC	cycles	20 · 10 ⁶ / 50 · 10 ⁶	20 · 10 ⁶ / 50 · 10 ⁶	20 · 10 ⁶ / 50 · 10 ⁶
Electrical life at rated load AC1	cycles	200 · 10 ³	200 · 10 ³	150 · 10 ³
Operate/release time	ms	10/5 (AC) - 10/15 (DC)	10/5 (AC) - 10/15 (DC)	11/3 (AC) - 11/15 (DC)
Insulation between coil and contacts (1.2/50 μs)	kV	3.6	3.6	3.6
Dielectric strength between open contacts	V AC	1000	1000	1000
Ambient temperature range	°C	-40...+70	-40...+70	-40...+70
Protection category		IP 20	IP 20	IP 20

Approvals relay (according to type)



58.32	58.33	58.34
<ul style="list-style-type: none"> • 2 CO 10 A • Screw terminals 	<ul style="list-style-type: none"> • 3 CO 10 A • Screw terminals 	<ul style="list-style-type: none"> • 4 CO 7 A • Screw terminals
<p>Example: AC</p>	<p>Example: DC</p>	<p>Example: AC</p>

2 & 4 CO relay interface modules, 27 mm wide with Screw terminals ATEX compliant (EX nA nC)

Type 58.32 - x0xx

- 2 CO 10 A
- Screw terminals

Type 58.34 - x0xx

- 4 CO 6 A
- Screw terminals

- AC coils or DC coils
- Supply status indication and EMC coil suppression module as standard
- Mechanical indicator - optional on 2 & 4 CO types
- Identification label
- Cadmium Free contacts
- UL Listed
- Complies with:
 - EN 60079-0:2012 and EN 60079-15:2010
 - 94/9/CE and 2014/34/UE
- 35 mm rail (EN 60715) mounting

58.32 / 58.34 - x0xx
Screw terminals



For outline drawing see page 9

Contact specification

Contact configuration		2 CO (DPDT)	4 CO (4PDT)
Rated current/Maximum peak current	A	10/20	6/15
Rated voltage/Maximum switching voltage	V AC	250/400	250/250
Rated load AC1	VA	2500	1500
Rated load AC15 (230 V AC)	VA	500	350
Single phase motor rating (230 V AC)	kW	0.37	0.125
Breaking capacity DC1: 30/110/220 V	A	10/0.25/0.12	6/0.25/0.12
Minimum switching load	mW (V/mA)	300 (5/5)	300 (5/5)
Standard contact material		AgNi	AgNi

Coil specification

Nominal voltage (U_N)	V AC (50/60 Hz)	12 - 24 - 48 - 110 - 120 - 230	12 - 24 - 48 - 110 - 120 - 230
	V DC	12 - 24 - 48 - 125	12 - 24 - 48 - 125
Rated power AC/DC	VA (50 Hz)/W	1.5/1	1.5/1
Operating range	AC	$(0.8 \dots 1.1) U_N$	$(0.8 \dots 1.1) U_N$
	DC	$(0.8 \dots 1.1) U_N$	$(0.8 \dots 1.1) U_N$
Holding voltage	AC/DC	$0.8 U_N / 0.5 U_N$	$0.8 U_N / 0.5 U_N$
Must drop-out voltage	AC/DC	$0.2 U_N / 0.1 U_N$	$0.2 U_N / 0.1 U_N$

Technical data

Mechanical life AC/DC	cycles	$20 \cdot 10^6 / 50 \cdot 10^6$	$20 \cdot 10^6 / 50 \cdot 10^6$
Electrical life at rated load AC1	cycles	$150 \cdot 10^3$	$150 \cdot 10^3$
Operate/release time	ms	11/3 (AC) - 11/15 (DC)	11/3 (AC) - 11/15 (DC)
Insulation between coil and contacts (1.2/50 μ s)	kV	3.6	3.6
Dielectric strength between open contacts	V AC	1000	1000
Ambient temperature range	$^{\circ}$ C	-40...+70	-40...+70
Protection category		IP 20	IP 20

Approvals relay (according to type)



NEW 58.32 - x0xx



- 2 CO 10 A
- Screw terminals
- ATEX compliant

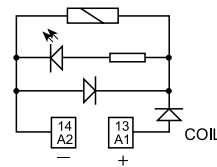
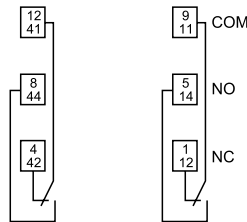

Example: DC

NEW 58.34 - x0xx



- 4 CO 6 A
- Screw terminals
- ATEX compliant

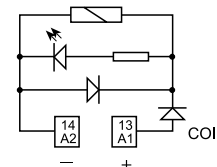
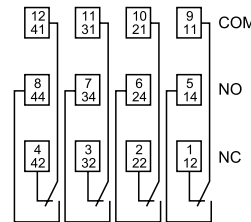

Example: DC

Ordering information

Example: 58 series, 35 mm rail (EN 60715) mounting, Push-in terminals interface module, 4 CO, 24 V DC coil, green LED + diode.

B Series 5 8 . P 4 . 9 . 0 2 4 . 0 0 5 0

Type
3 = Screw terminals
35 mm rail (EN 60715) mount
P = Push-in terminals
35 mm rail (EN 60715) mount

No. of poles
2 = 2 pole, 10 A
3 = 3 pole, 10 A
4 = 4 pole, 7 A

Coil version
8 = AC (50/60 Hz)
9 = DC

Coil voltage
See coil specifications

A: Contact material
0 = AgNi Standard
5 = AgNi + Au

B: Contact circuit
0 = CO (nPDT)

C: Options
5 = Standard DC: green LED + diode (polarity +A1)
6 = Standard AC: green LED + Varistor

D: Special versions
0 = Standard

Selecting features and options: only combinations in the same row are possible.
Preferred selections for best availability are shown in **bold**.

Type	Coil version	A	B	C	D
58.P3/P4/32/33/34	AC	0 - 5	0	6	0
58.P3/P4/32/33/34	DC	0 - 5	0	5	0

Ordering information ATEX versions

Example: 58 series, 35 mm rail (EN 60715), screw terminal interface module, 4 CO, 120 V AC, green LED, mechanical indicator, ATEX version

5 8 . 3 4 . 8 . 1 2 0 . 0 0 4 9

Series

Type
3 = Screw terminals
35 mm rail (EN 60715) mount

No. of poles
2 = 2 pole, 10 A
4 = 4 pole, 6 A

Coil version
8 = AC (50/60 Hz)
9 = DC

Coil voltage
See coil specifications

A: Contact material
0 = AgNi Standard
2 = AgCdO
5 = AgNi + Au

B: Contact circuit
0 = CO (nPDT)

C: Options
4 = Module 99 LED (AC/DC)
5 = Module 99 LED + Diode (DC)

D: Special versions
8 = ATEX compliant (Ex nA nC) without mechanical indicator
9 = ATEX compliant (Ex nA nC) with mechanical indicator

Technical data

Insulation					
Insulation according to EN 61810-1	insulation rated voltage	V	400 (2-3 pole)	250 (4 pole)	
	rated impulse withstand voltage	kV	3.6 (2-3 pole)	2.5 (4 pole)	
	pollution degree		2	2	
	overvoltage category		III	II	
Insulation between coil and contacts (1.2/50 µs)		kV	3.6		
Dielectric strength between open contacts		V AC	1000		
Dielectric strength between adjacent contacts		V AC	2000 (58.32,58.33, 58.P3)	1550 (58.34, 58.P4)	
Conducted disturbance immunity					
Burst (5...50)ns, 5 kHz, on A1 - A2 according to EN 61000-4-4			level 4 (4 kV)		
Surge (1.2/50 µs) on A1 - A2 (differential mode) according to EN 61000-4-5			level 4 (4 kV)		
Other data					
Bounce time: NO/NC		ms	1/3		
Vibration resistance (10...55)Hz: NO/NC		g	6/6		
Power lost to the environment	without contact current	W	1		
	with rated current	W	3 (58.32, 58.34, 58.P4)	4 (58.P3, 58.33)	
			58.32/33/34 (screw terminals)	58.P3/P4 (Push-in terminals)	
Wire strip length		mm	8		
Screw torque		Nm	0.5		
Min. wire size	solid cable	mm ²	0.5	0.5	
		AWG	21	21	
	stranded cable	mm ²	1 x 6 / 2 x 2.5	1 x 4 / 2 x 2.5	2 x 1.5 / 1 x 2.5
		AWG	1 x 10 / 2 x 14	1 x 12 / 2 x 14	2 x 16 / 1 x 14
Max. wire size	solid cable	mm ²	0.5	0.5	
		AWG	21	21	
	stranded cable	mm ²	1 x 6 / 2 x 2.5	1 x 4 / 2 x 2.5	2 x 1.5 / 1 x 2.5
		AWG	1 x 10 / 2 x 14	1 x 12 / 2 x 14	2 x 16 / 1 x 14

Other data ATEX versions

Max current @ 70 °C		Single piece mount	> 1 piece mount
Type 58.32	A	10	7
Type 58.34	A	6	5
Terminal			
Wire strip length		mm	8
Screw torque		Nm	0.5
Wire size	solid cable		stranded cable
	mm ²	1 x 2.5	2 x 1.5
	AWG	1 x 12	2 x 16

Markings - ATEX versions - ATEX, II 3G Ex nA nC IIC Gc

MARKING	
Specific marking of explosion protection	
II	
Component for surface plant (different from mines)	
3	
Category 3: normal level of protection	
GAS	G
	Explosive atmosphere due to presence of combustible gas vapour or mist
	Ex nA
	Non-sparking equipment
	Ex nC
Sealed device (type of protection for category 3G)	
IIC	
Gas group	
Gc	
Equipment Protection Level	
-40 °C ≤ Ta ≤ +70 °C	
Ambient temperature	
EPT 15 ATEX 0195 U	
EPT: laboratory which issues the CE type certificate	
15: year of issue of certificate	
0195: number of CE type certificate	
U: ATEX component	

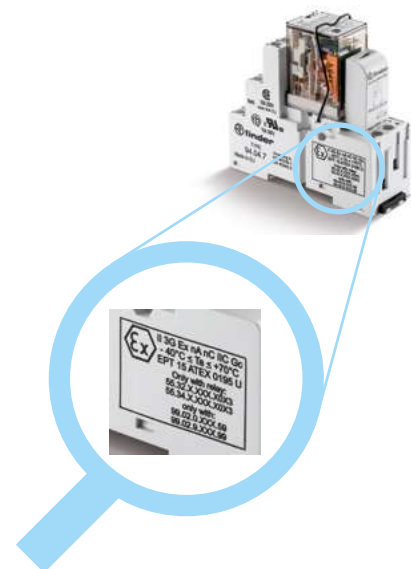

Contact specification

F 58 - Electrical life (AC) v contact current
2 & 3 pole relays

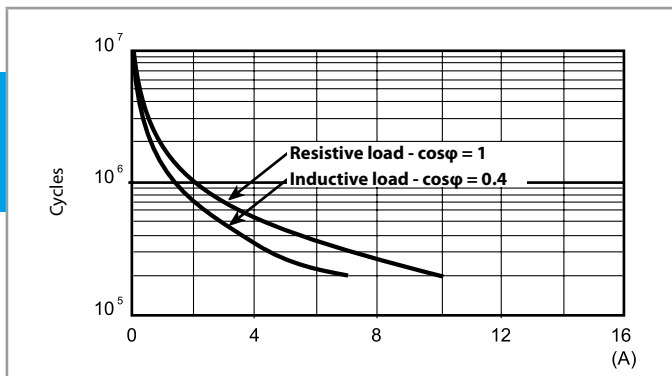

F 58 - Electrical life (AC) v contact current
4 pole relay

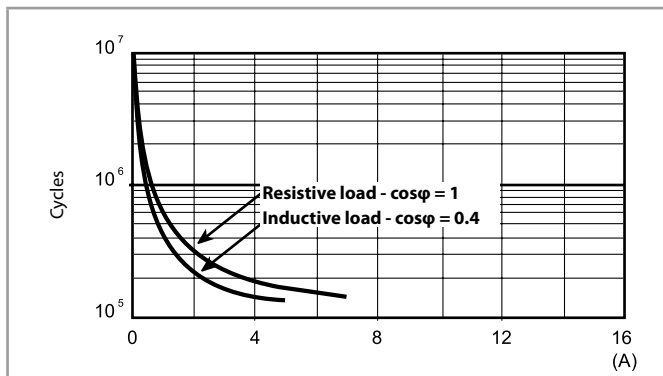

H 58 - Maximum DC1 breaking capacity

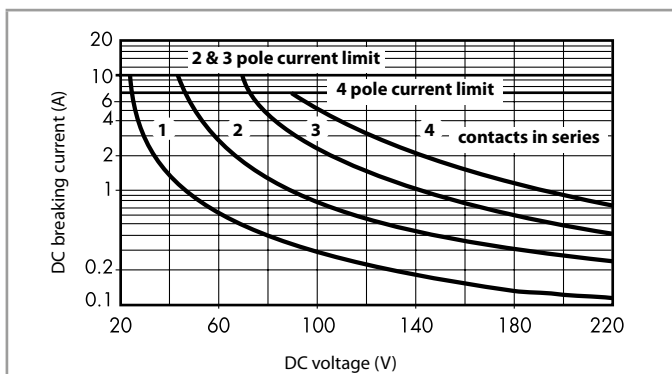

- When switching a resistive load (DC1) having voltage and current values under the curve, an electrical life of $\geq 100 \cdot 10^3$ can be expected.
- In the case of DC13 loads, the connection of a diode in parallel with the load will permit a similar electrical life as for a DC1 load.
Note: the release time for the load will be increased.

Coil specifications

DC coil data

Nominal voltage	Coil code	Operating range		Resistance	Rated coil absorption
		U_{min}	U_{max}		
U_N		V	V	R	I at U_N
V		V	V	Ω	mA
12	9.012	9.6	13.2	140	86
24	9.024	19.2	26.4	600	40
48	9.048	38.4	52.8	2400	20
125	9.125	100	138	17300	7.2

AC coil data

Nominal voltage	Coil code	Operating range		Resistance	Rated coil absorption
		U_{min}	U_{max}		
U_N		V	V	R	I at U_N (50 Hz)
V		V	V	Ω	mA
12	8.012	9.6	13.2	50	97
24	8.024	19.2	26.4	190	53
48	8.048	38.4	52.8	770	25
110	8.110	88	121	4000	12.5
120	8.120	96	132	4700	12
230	8.230	184	253	17000	6

R 58 - DC coil operating range v ambient temperature

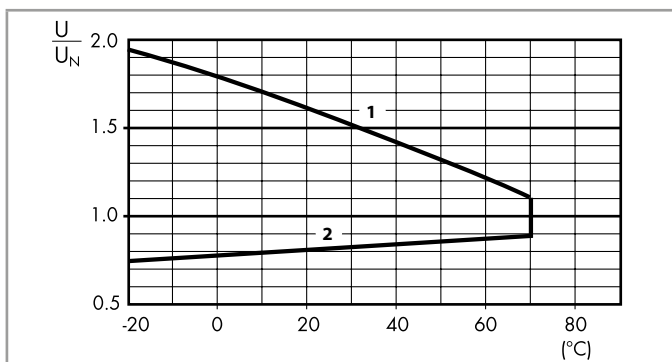

- 1 - Max. permitted coil voltage.
2 - Min. pick-up voltage with coil at ambient temperature.

R 58 - AC coil operating range v ambient temperature

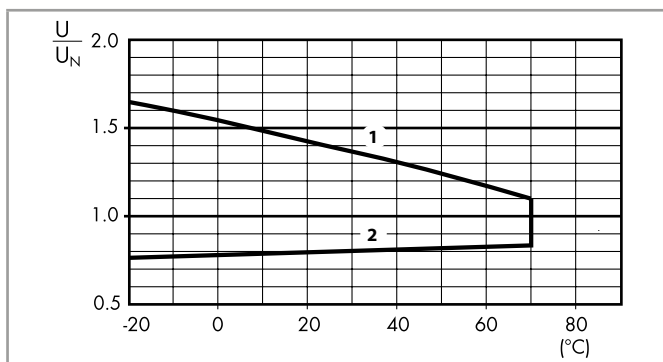

- 1 - Max. permitted coil voltage.
2 - Min. pick-up voltage with coil at ambient temperature.

Combinations

Certain relay/socket combinations

Code	Type of socket	Type of relay	Module	Retaining clip
58.P3	94.P3	55.33	99.02	094.91.3
58.P4	94.P4	55.34	99.02	094.91.3
58.32	94.02	55.32	99.02	094.91.3
58.33	94.03	55.33	99.02	094.91.3
58.34	94.04	55.34	99.02	094.91.3

Outline drawing

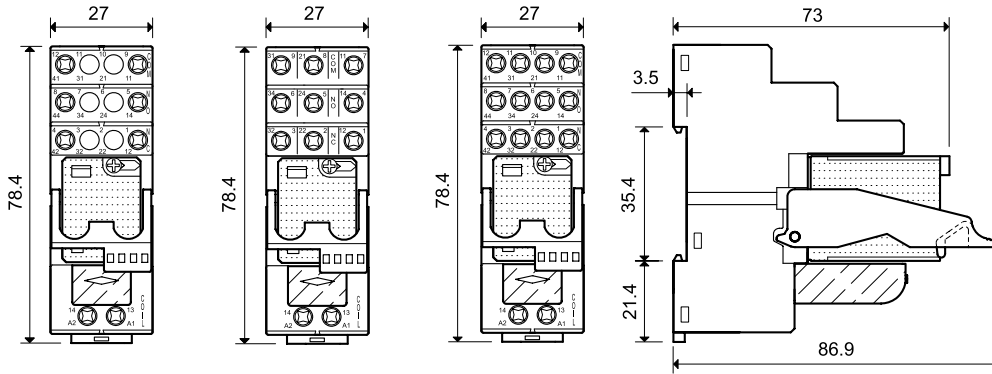

58.32
Screw terminals



58.33
Screw terminals



58.34
Screw terminals

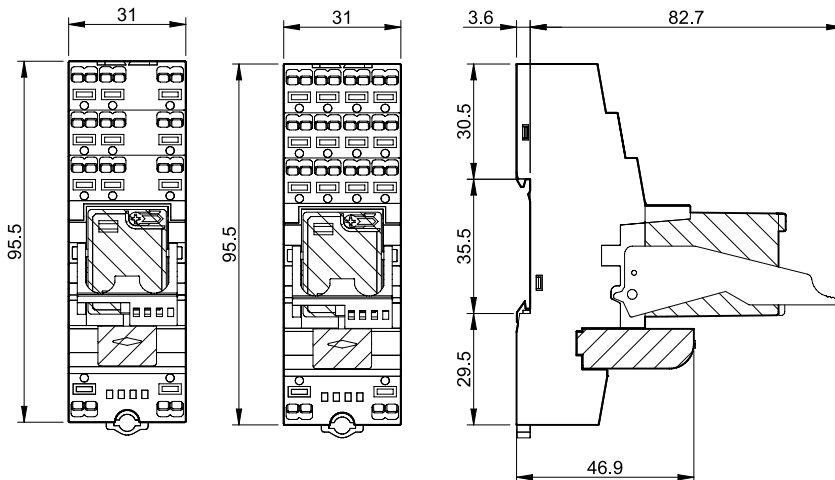

58.P3
Push-in terminal



58.P4
Push-in terminal



Accessories

2-way jumper link for type 58.P3 and 58.P4	094.52.1
Rated values	10 A - 250 V

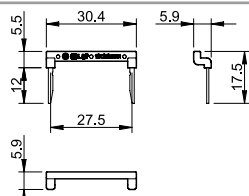

094.52.1

2-way jumper link for type 58.P3 and 58.P4	097.52
Rated values	10 A - 250 V

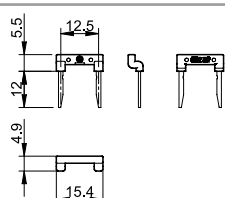

097.52

Marker tag holder for type 58.P3, 58.P4, 58.32, 58.33 and 58.34	097.00
--	--------

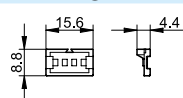

097.00

6-way jumper link for type 58.32, 58.33, 58.34	094.06 (blue)	094.06.0 (black)
Rated values	10 A - 250 V	

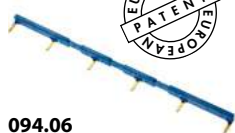
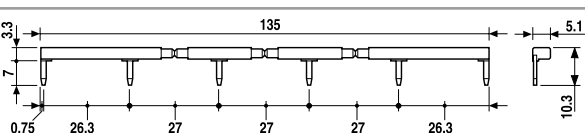

094.06

6-way jumper link for type 58.P3 and 58.P4	094.56 (blue)
Rated values	10 A - 250 V

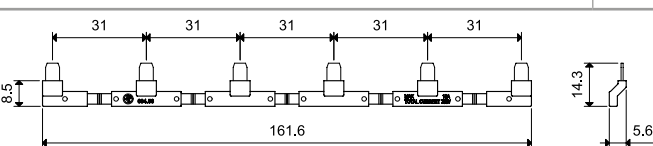

094.56

Sheet of marker tags, plastic, 48 tags, 6 x 12 mm	060.48
--	--------

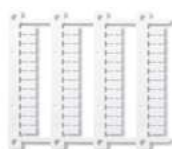

060.48

Packaging codes

How to code and identify retaining clip and packaging options for sockets.

Example:

5 8 . P 4 . 9 . 0 2 4 . 0 0 5 0 S P A

A Standard packaging
B Blister packaging

SP Plastic retaining clip
SM Metallic retaining clip
(58.32/33/34 - x0xx only)

Relay actuators & Status indicating modules



Panels for
electrical
distribution



Auto/Off/On output module 10 A

- Auto/Off/On output module intended to permit the automatic control of pumps, blowers or motor groups. Or, in the case of installation, maintenance or failure, to permit the load equipment to be turned "Off" or turned "On"
- Ideal interface for PLC and electronic systems
- Only 11.2 mm wide
- 3 function selector switch:
 - Auto: works as a monostable relay (following A3 input)
 - Off: relay permanently OFF
 - On: relay permanently ON
- 24 V AC/DC supply and module input
- 35 mm rail (EN 60715) mounting

Application examples:

- control of pumps, blowers or motor groups
- primarily suited to Industrial control systems

Wiring diagram

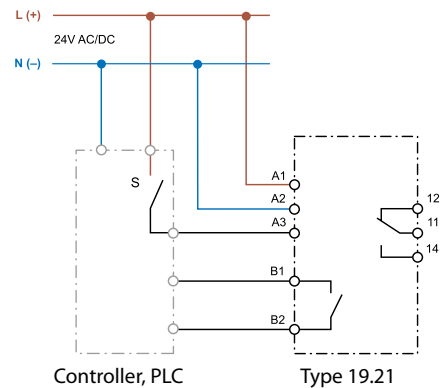

19.21.0.024.0000



- 1 CO output contact
- 11.2 mm wide
- Feedback contact

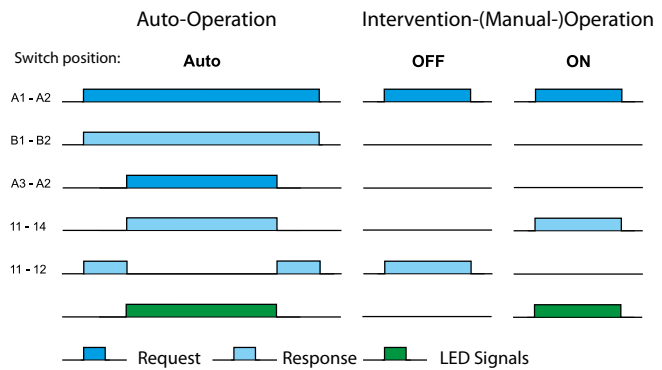

B1-B2 feedback to the controller signaling Auto-operation
A3-A2 "Auto" signal from Controller

For outline drawing see page 9

Contact specification

Contact configuration		1 CO (SPDT)
Rated current/Maximum peak current	A	10/15
Rated voltage/ Maximum switching voltage	V AC	250/400
Rated load AC1	VA	2500
Rated load AC15 (230 V AC)	VA	500
Single phase motor rating (230 V AC)	kW	0.44
Breaking capacity DC1 (24/110/220 V)	A	10/0.3/0.12
Minimum switching load	mW (V/mA)	300 (5/5)
Standard contact material		AgSnO ₂

Feedback contact specification (terminals B1-B2)

Contact configuration		1 NO (SPST-NO)
Maximum current	mA	300
Rated voltage	V AC/DC	24

Supply & Input specification

Nominal voltage (U _N)	V AC (50/60 Hz)	24
	V DC	24
Rated power	VA (50 Hz)/W	0.6/0.4
Operating range	AC	(0.8...1.1)U _N
	DC	(0.8...1.1)U _N

Technical data

Ambient temperature range	°C	-20...+50
Protection category		IP 20

Approvals (according to type)



Analogue override module - Auto/Hand (0...10)V

- Analogue output module intended to provide, by the selection switch on the front panel, a (0...10)V output, automatically or by hand.
- With the selector switch in position "A" (Automatic) the (0...10)V signal is derived from the controller.
- In position "H" (Hand) the controller signal is ignored and the (0...10)V signal is derived directly from the potentiometer setting on the face of the module
- The level of the (0...10)V output signal is displayed by 3 green LEDs, set at > 25%, > 50% and > 75%.
- 24 V AC/DC supply
- 35 mm rail (EN 60715) mounting

Application examples:

- permits the direct control of proportional valves under exceptional circumstances or where the automatic controller has failed

Wiring diagram

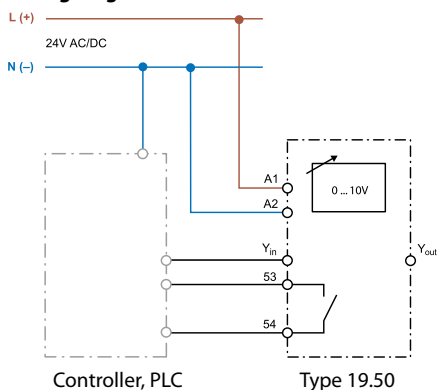

19.50.0.024.0000



- Analogue output (0...10)V, plus 1 feedback output contact
- 17.5 mm wide
- LED indicator

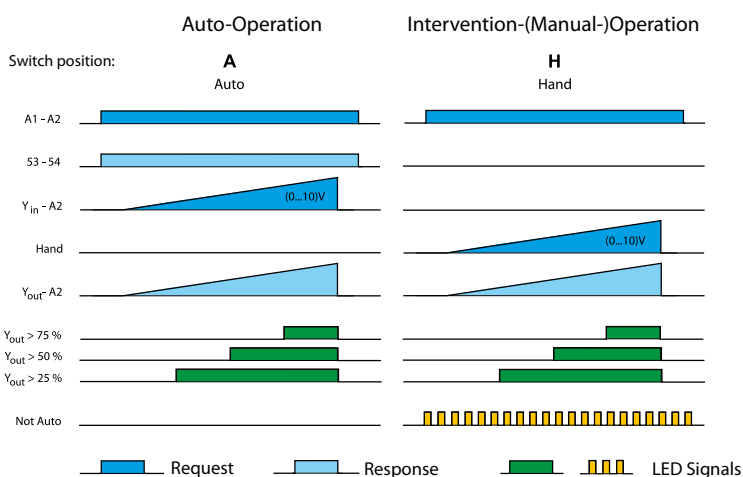

53-54 feedback to the controller signaling Auto-operation
 Y_{in}-A2 variable (0...10)V DC from the controller
 Hand (0...10)V DC value set by the potentiometer

For outline drawing see page 9

(0...10)V Signal specification (terminal Y-in)

Input control signal	V DC	0...10 (I _{max} 20 mA - short-circuit protected)
Green LED 25%		> 2.5 V
Green LED 50%		> 5 V
Green LED 75%		> 7.5 V

Feedback output specification (terminals 53-54)

Output configuration		1 NO (SPST-NO)
Maximum / Minimum current	mA	100/10
Rated voltage	V AC/DC	24

Supply & Input specification

Nominal voltage (U _N)	V AC (50/60 Hz)	24
	VDC	24
Rated power AC/DC	VA (50 Hz)/W	0.9/0.7
Operating range	AC	(0.8...1.1)U _N
	DC	(0.8...1.1)U _N

Technical data

Ambient temperature range	°C	-20...+50
Protection category		IP 20

Approvals (according to type)



Power relay module 16 A

- Suitable for Lamps load
- AgSnO₂ contacts for heavy duty, high inrush current loads
- DC supply (12 or 24 V)
- LED indicator
- Reinforced insulation between supply and contacts
- Cadmium Free contacts
- 35 mm rail (EN 60715) mounting

Wiring diagram

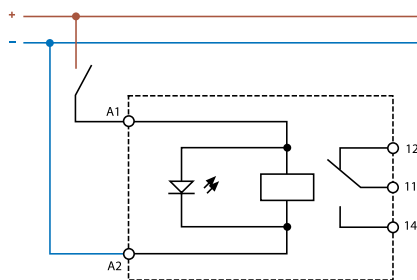

For outline drawing see page 9

Contact specification

Contact configuration		1 CO (SPDT)
Rated current/Maximum peak current	A	16/30 (120 A - 5 ms)
Rated voltage/ Maximum switching voltage	V AC	250/440
Rated load AC1	VA	4000
Rated load AC15 (230 V AC)	VA	750
Nominal lamp rating (230 V):		
incandescent/halogen W		2000
fluorescent tubes with electronic ballast W		1000
fluorescent tubes with electromechanical ballast W		750
CFL W		400
230 V LED W		400
halogen or LED with electronic ballast W		400
halogen or LED with electromechanical ballast W		800
Minimum switching load	mW	300 (5 V/ 5 mA)
Standard contact material		AgSnO ₂

Coil specification

Nominal voltage (U _N)	VDC	12 - 24
Rated power DC	W	0.5
Operating range		(0.8 ... 1.1)U _N

Technical data

Mechanical life AC/DC	cycles	10 · 10 ⁶
Electrical life at rated load AC1	cycles	80 · 10 ³
Operate/release time	ms	12/8
Ambient temperature range	°C	-20...+50
Protection category		IP 20

Approvals (according to type)



19.91.9.0xx.4000



- 1 Pole changeover contact
- 17.5 mm

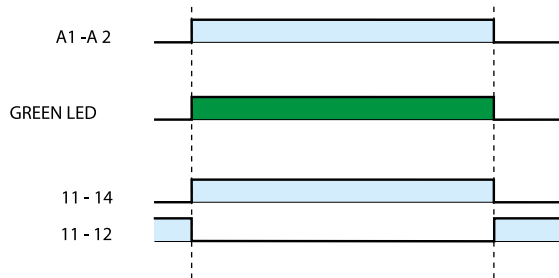

Switching actuator with KNX technology - 16 A**Compact and powerful switching actuator with 6 relay outputs**

- 6 output contacts rated 16 A 250 V AC, individually configurable NO or NC
- LED status indicator for each output
- Time functions (ON, OFF, Blink, Staircase)
- Independent logic and analog functions for each output (AND, OR, XOR, THRESHOLD, WINDOW)
- Scenario Management
- Output control area for manual control
- Supply voltage via KNX bus
- 35 mm rail (EN 60715) mounting

NEW 19.6K.9.030.4300



- Bistable relay ENEC approved (Maximum peak current up to 120 A)
- Suitable for lamp loads

19.6K
Screw terminal



For outline drawing see page 9

Contact specification

Contact configuration (via ETS)	V AC	NO - NC
Rated current/Maximum peak current	A	16/120 (5 ms)
Rated voltage/ Maximum switching voltage	V	250/400
Rated load AC1	VA	4000
Rated load AC15 (230 V AC)	VA	750
Single phase motor rating (230 V AC)	kW	0.5
Nominal lamp rating (230 V):		
incandescent/halogen W		2000
fluorescent lamp with electronic ballast W		1000
fluorescent lamp with electromechanical ballast W		750
CFL W		400
LED 230 V W		400
halogen or LV LED with electronic ballast W		400
halogen or LV LED with electromechanical ballast W		800
Standard contact material		AgSnO ₂

Supply specification

Supply voltage	VDC	30
Rated current	mA	12

Technical data

Mechanical life	cycles	10 · 10 ⁶
Electrical life at rated load AC1	cycles	100 · 10 ³
Ambient temperature range	°C	-5...+45
Protection category		IP 20

Approvals (according to type)



Ordering information

Example: 19 series Auto/Off/On override module, 1 CO (SPDT) 10 A contact, 24 V AC/DC supply.



Series

Type

- 21 = Auto/Off/On output module, 11.2 mm
- 50 = Analogue override module (0...10)V
- 91 = Power relay module
- 6K = KNX actuator, 6 poles 16 A

Supply version

- 0 = AC (50/60 Hz)/DC
- 9 = DC

Supply voltage

- 012 = 12 V
- 024 = 24 V
- 030 = KNX Bus

Contact circuit

- 0 = Standard
- 3 = NO (19.6K)

Contact material

- 0 = Standard for 19.21, 19.50
- 4 = Standard for 19.91, 19.6K

Codes / Module width

- 19.21.0.024.0000/11.2 mm
- 19.50.0.024.0000/17.5 mm
- 19.91.9.012.4000/17.5 mm
- 19.91.9.024.4000/17.5 mm
- 19.6K.9.030.4300/70 mm

Technical data

Insulation		19.21	19.50	19.91	
Dielectric strength (V AC)	between supply and contacts	3000	—	4000	
	between open contacts	1000	—	1000	
	between supply and feedback output	2000	1500	—	
EMC specifications					
Type of test		Reference standard	19.21/91	19.50	
Electrostatic discharge	contact discharge	EN 61000-4-2	4 kV		
	air discharge	EN 61000-4-2	8 kV		
Radiated electromagnetic field (80...1000 MHz)		EN 61000-4-3	30 V/m		
Fast transients (burst) (5-50 ns, 5 kHz)		EN 61000-4-4	4 kV		
Voltage pulses (1.2/50 µs)	common mode	EN 61000-4-5	2 kV	1 kV	
	on supply terminals	EN 61000-4-5	1 kV	0.5 kV	
Terminals		19.21/6K	19.50/91		
Screw torque	Nm	0.5			
		solid cable		0.8	
		stranded cable		0.8	
Max. wire size	mm ²	solid cable	stranded cable	solid cable	stranded cable
		1 x 6 / 2 x 2.5	1 x 4 / 2 x 1.5	1 x 6 / 2 x 4	1 x 4 / 2 x 2.5
		AWG 1 x 10 / 2 x 14	1 x 12 / 2 x 16	1 x 10 / 2 x 12	1 x 12 / 2 x 14
Wire strip length	mm	7		9	

Wiring diagrams - Application examples

Type 19.21

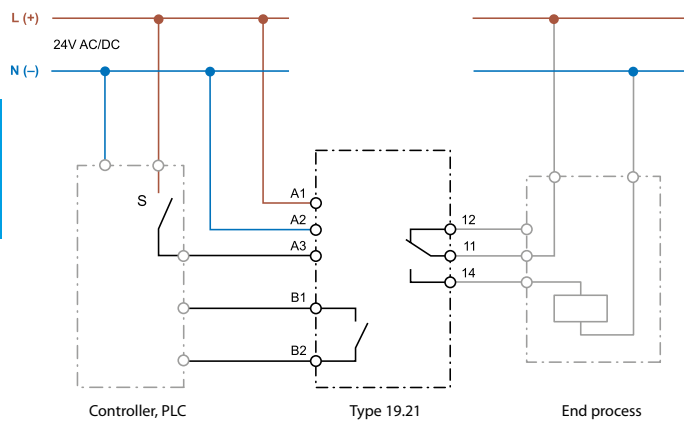

B

Type 19.50

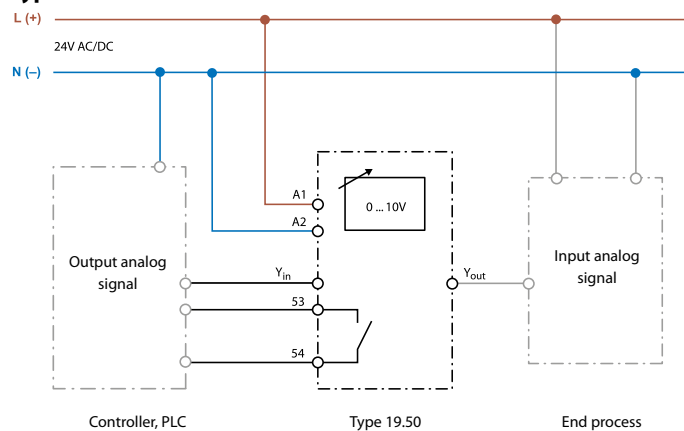

In selector position A (Automatic) the (0...10)V controller variable is transferred via Yin - A2 and Yout to the end process.
In selector position H (Hand) the (0...10)V value set by the regulator is transferred via Yout to the end process.

Type 19.6K

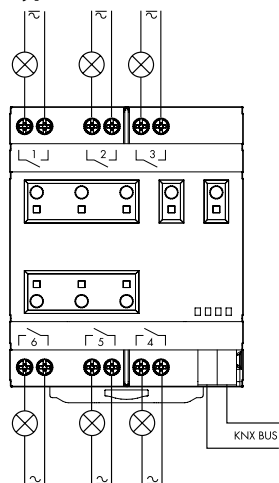

Outline drawings

Type 19.21
Screw terminal

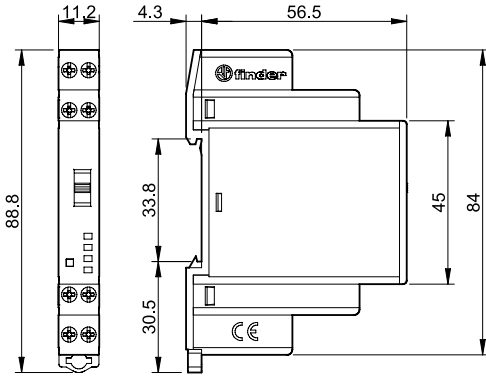

Type 19.50
Screw terminal

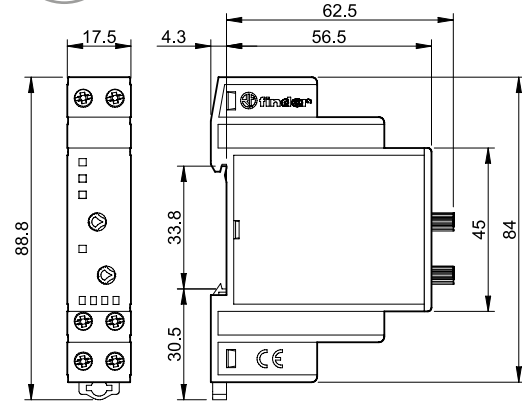

Type 19.91
Screw terminal

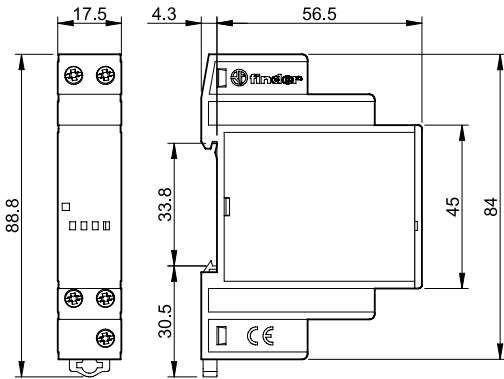

Type 19.6K
Screw terminal

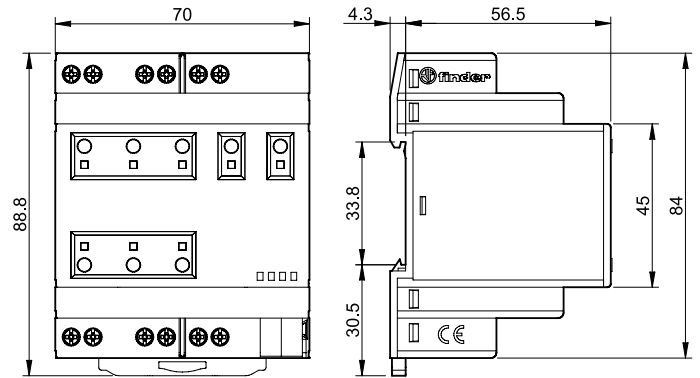

B

Accessories

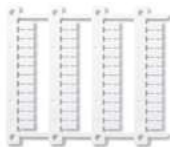

060.48

Sheet of marker tags (CEMBRE Thermal transfer printers) for 19.21/50/91/6K types
(48 tags), 6 x 12 mm

060.48

B



019.01

Identification tag, for 19.50 types, plastic, 1 tag, 17 x 25.5 mm

019.01



020.01

Adaptor for panel mounting, for 19.21/50/91 types, plastic, 17.5 mm wide

020.01

Application notes

Intervention Modules

The demand for security apparatus, heating, air conditioning or efficient energy use in offices, hotels, and private homes or in industrial space is growing constantly, leading to the installation of increasingly complex electronic systems. But what happens if these systems malfunction and a qualified service technician will only be available in a few hours, or even days?

With the use of carefully installed intervention modules, a trained caretaker or security guard can be in a position to recognize interruptions in service, and by manual intervention perform the necessary override actions to maintain system operation until a repair can be effected.

Digital Override control module

Auto-Off-On output module (Type 19.21)

Many processes or systems are automatically controlled by an electronic control system or by a Programmable Logic Controller.

In the event of an electronic system malfunction it is important, in order to avoid damage or downtime, to plan for the possibility of controlling the process manually. An Auto-Off-On Module can provide this, located between the output of the electronic system (Controller) and the process to be controlled (End Process) - bypassing the malfunctioning control unit in a planned way. For malfunctioning electronic systems, the process to be controlled can be manually switched On or Off, as needed, using the switch on the front of the unit. Under healthy functioning of the electronic system, the switch is left in the Auto position. In this configuration the process is controlled by the normal functioning of the electronic system and its output. It may be important to know (remotely) if the process is being controlled manually or automatically, in which case the feedback contact on the Auto-Off-On module 19.21 can provide this.

Analogue Override control module

Analogue output module (0...10)V (Type 19.50)

This module can be installed where there is need to give a manually adjustable analog signal (0...10)V priority over an analog signal from a electronic control unit or PLC, or to override and replace a malfunctioning signal.

The Analogue override module provides, by the selection switch on the front panel, a (0...10)V output signal either generated automatically or by hand. With the selector switch in position "A" (Automatic) the (0...10)V signal at Yout-A2 is derived from the controller signal applied to terminals Yin-A2. In position "H" (Hand) the controller signal is ignored and the (0...10)V signal is derived directly from the potentiometer setting on the module front panel.

Operation in switch position H is indicated by a blinking yellow LED, and by the opening of contact 51-52 – which could be used to report the override condition to the central control room.

The level of the (0...10)V output signal is displayed by 3 green LEDs, set at > 25%, > 50% and > 75%



finder[®]
SWITCH TO THE FUTURE

50
SERIES

PCB Relay with forcibly guided contacts 8 A



Hoists and cranes



Escalators



Medical and dentistry



Hospitals



Carousel warehouses



Elevators and lifts



Disabled lift



Wood-processing machines

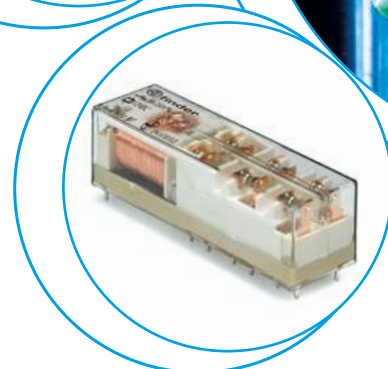

PCB Relay with forcibly guided contacts according to EN 61810-3 (previously EN 50205) Type B 2 CO contacts*

Type 50.12...1000
- 2 pole 8 A
- Contact AgNi

Type 50.12...5000
- 2 pole 8 A
- Contact AgNi + Au

- High physical separation between adjacent contacts
- Cadmium Free contact materials
- 8 mm, 6 kV (1.2/50 μs) isolation, coil-contacts
- Flux proof: RT II

50.12...1000



- For medium duty switching, suggested for DC loads
- 2 pole 8 A
- 5 mm pinning
- PCB mounting

50.12...5000



- For safety applications
- Gold plate contacts for low level switching capability
- 5 mm pinning
- PCB mounting

* According to EN 61810-3 only 1 NO and 1 NC (11-14 and 21-22 or 11-12 and 21-24) shall be used as forcibly guided contacts.

FOR UL RATINGS SEE:
"General technical information" page V

For outline drawing see page 7

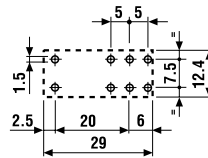
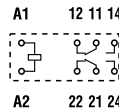

Copper side view

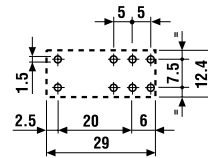
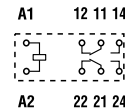

Copper side view

Contact specification

Contact configuration		2 CO (DPDT)	2 CO (DPDT)
Rated current/Maximum peak current	A	8/15	8/15
Rated voltage/Maximum switching voltage	V AC	250/400	250/400
Rated load AC1	VA	2000	2000
Rated load AC15 (230 V AC)	VA	500	500
Single phase motor rating (230 V AC)	kW	0.37	0.37
Breaking capacity DC1: 30/110/220 V	A	8/0.65/0.2	8/0.65/0.2
Minimum switching load	mW (V/mA)	500 (10/10)	50 (5/5)
Standard contact material		AgNi	AgNi + Au

Coil specification

Nominal voltage (U _N)	V AC (50/60 Hz)	—	—
	V DC	5 - 6 - 12 - 24 - 48 - 60 - 110 - 125	5 - 6 - 12 - 24 - 48 - 60 - 110 - 125
Rated power AC/DC	VA (50 Hz)/W	—/0.7	—/0.7
Operating range	AC (50 Hz)	—	—
	DC	(0.75...1.2)U _N	(0.75...1.2)U _N
Holding voltage	AC/DC	—/0.4 U _N	—/0.4 U _N
Must drop-out voltage	AC/DC	—/0.1 U _N	—/0.1 U _N

Technical data

Mechanical life AC/DC	cycles	—/10 · 10 ⁶	—/10 · 10 ⁶
Electrical life at rated load AC1	cycles	100 · 10 ³	100 · 10 ³
Operate/release time	ms	10/4	10/4
Insulation between coil and contacts (1.2/50 μs)	kV	6 (8 mm)	6 (8 mm)
Dielectric strength between open contacts	V AC	1500	1500
Ambient temperature range	°C	−40...+70	−40...+70
Environmental protection		RT II	RT II

Approvals (according to type)



PCB Relay with forcibly guided contacts according to EN 61810 (previously EN 50205) Type A
Type 50.14...4220/4310

- 4 pole 8 A (2 NO + 2 NC) or (3 NO + 1 NC)
- Contact AgSnO₂

Type 50.16...5420/5510

- 6 pole 8 A (4 NO + 2 NC) or (5 NO + 1 NC)
- Contact AgSnO₂ + Au
- High physical separation between adjacent contacts
- Cadmium Free contact materials
- DC coil 800 mW
- 8 mm, 6 kV (1.2/50 μs) isolation, coil-contacts
- PCB mounting
- Wash tight: RT III

50.14

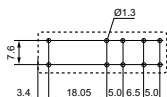
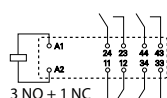
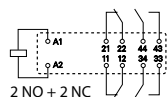

- For safety applications
- 4 pole 8 A
- PCB mounting



Copper side view

50.16

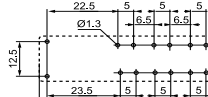
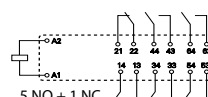
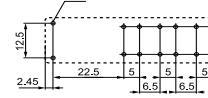
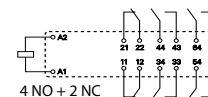
- For safety applications
- 6 pole 8 A
- PCB mounting



Copper side view

FOR UL RATINGS SEE:

"General technical information" page V

For outline drawing see page 7

Contact specification

Contact configuration		2 NO + 2 NC, 3 NO + 1 NC	4 NO + 2 NC, 5 NO + 1 NC
Rated current/Maximum peak current	A	8/15	8/15
Rated voltage/ Maximum switching voltage	V AC	250/400	250/400
Rated load AC1	VA	2000	2000
Rated load AC15 (230 V AC)	VA	700	1100
Single phase motor rating (230 V AC)	kW	0.37	0.37
Breaking capacity DC1: 30/110/220 V	A	8/0.6/0.2	8/0.6/0.2
Minimum switching load	mW (V/mA)	50 (5/10)	50 (5/10)
Standard contact material		AgSnO ₂	AgSnO ₂ + Au

Coil specification

Nominal voltage (U _N)	V AC (50/60 Hz)	—	—
	V DC	12 - 24 - 48 - 110	12 - 24 - 48 - 110
Rated power AC/DC	VA (50 Hz)/W	—/0.8	—/0.8
Operating range	AC (50 Hz)	—	—
	DC	(0.75...1.2)U _N	(0.75...1.2)U _N
Holding voltage	AC/DC	—/0.4 U _N	—/0.4 U _N
Must drop-out voltage	AC/DC	—/0.1 U _N	—/0.1 U _N

Technical data

Mechanical life AC/DC	cycles	—/10 · 10 ⁶	—/10 · 10 ⁶
Electrical life at rated load AC1	cycles	100 · 10 ³	100 · 10 ³
Operate/release time	ms	10/4	10/4
Insulation between coil and contacts (1.2/50 μs)	kV	6 (8 mm)	6 (8 mm)
Dielectric strength between open contacts	V AC	1500	1500
Ambient temperature range	°C	−40...+70	−40...+70
Environmental protection		RT III	RT III

Approvals (according to type)

Ordering information

Example: 50 series forcibly guided contacts, 2 CO (DPDT) 8 A contacts, 24 V DC coil.

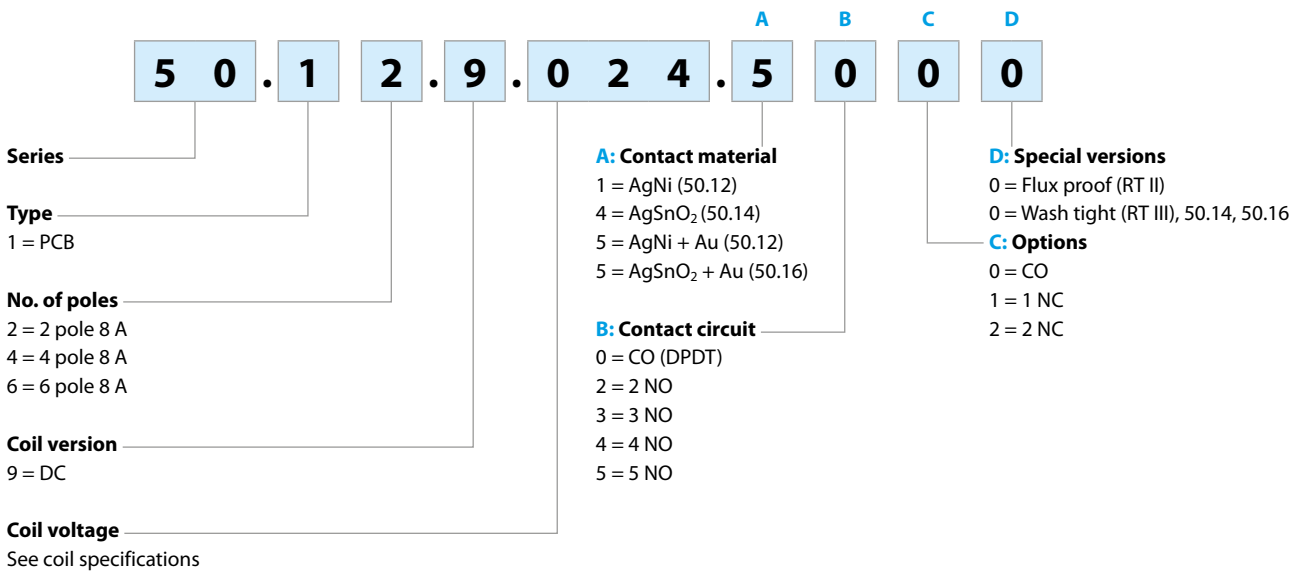

Technical data

Insulation according to EN 61810-1			
Nominal voltage of supply system	V AC	230/400	
Rated insulation voltage	V AC	250	400
Pollution degree		3	2
Insulation between coil and contact set			
Type of insulation		Reinforced (8 mm)	
Overvoltage category		III	
Rated impulse voltage	kV (1.2/50 µs)	6	
Dielectric strength	V AC	4000	
Insulation between adjacent contacts			
Type of insulation		Basic	
Overvoltage category		III	
Rated impulse voltage	kV (1.2/50 µs)	4	
Dielectric strength (50.12, 50.16)	V AC	3000	
Dielectric strength (50.14)	V AC	2500	
Insulation between open contacts			
Type of disconnection		Micro-disconnection	
Dielectric strength	V AC/kV (1.2/50 µs)	1500/2.5	
Insulation between coil terminals			
Rated impulse voltage (surge) differential mode (according to EN 61000-4-5)	kV(1.2/50 µs)	2	
Other data			
Bounce time: NO/NC	ms	2/10	
Vibration resistance (10...200)Hz: NO/NC	g	20/6	
Shock resistance NO/NC	g	20/5	
Power lost to the environment	without contact current	W	0.7
	with rated current	W	1.2
Recommended distance between relays mounted on PCB	mm	≥ 5	

Contact specification

F 50 - Electrical life (AC) v contact current (type 50.12)

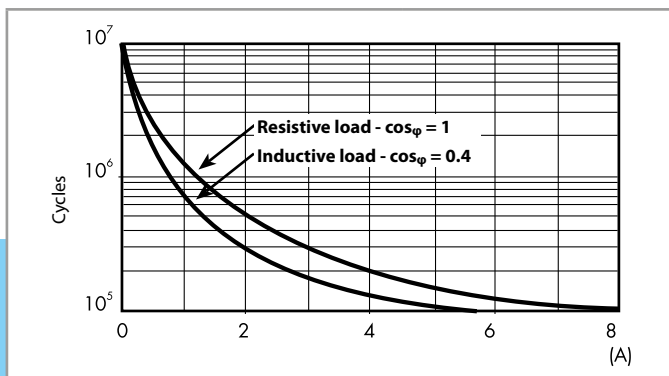

H 50 - Maximum DC1 breaking capacity (type 50.12)

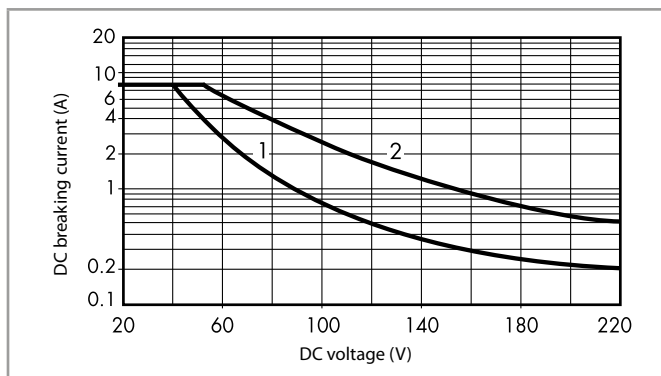

- When switching a resistive load (DC1) having voltage and current values under the curve, an electrical life of $\geq 100 \cdot 10^3$ can be expected.
- In the case of DC13 loads, the connection of a diode in parallel with the load will permit a similar electrical life as for a DC1 load.
Note: the release time for the load will be increased.

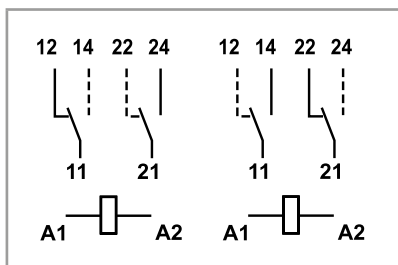

Alternative selection of NO and NC contacts to provide Forcibly guided (mechanically linked) contacts, in accordance with EN 61810-3 (type B).

Coil specifications

DC coil data (type 50.12)

Nominal voltage U_N V	Coil code	Operating range		Resistance R Ω	Rated coil consumption I at U_N mA
		U_{min} V	U_{max} V		
5	9.005	3.8	6	35	143
6	9.006	4.5	7.2	50	120
12	9.012	9	14.4	205	58.5
24	9.024	18	28.8	820	29.3
48	9.048	36	57.6	3280	14.4
60	9.060	45	72	5140	11.7
110	9.110	82.5	131	17250	6.4
125	9.125	93.7	150	22300	5.6

R 50 - DC coil operating range v ambient temperature

Standard coil (type 50.12)

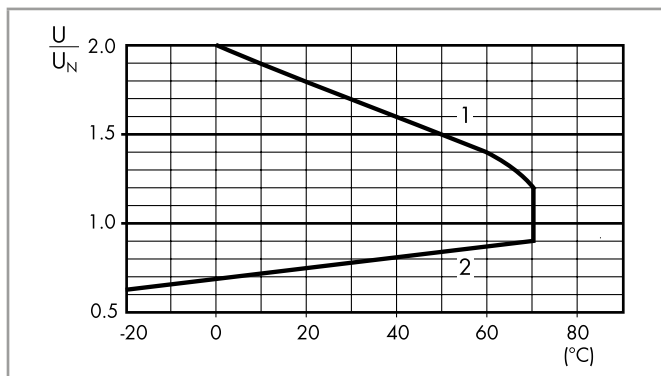

- 1 - Max. permitted coil voltage.
- 2 - Min. pick-up voltage with coil at ambient temperature.

DC coil data (type 50.14/16)

Nominal voltage U_N V	Coil code	Operating range		Resistance R Ω	Rated coil consumption I at U_N mA
		U_{min} V	U_{max} V		
12	9.012	9	14.4	180	66.6
24	9.024	18	28.8	720	33.3
48	9.048	36	57.6	2880	16.6
110	9.110	82.5	131	15125	7.7

Contact specification

F 50 - Electrical life (AC) v contact current (type 50.14)

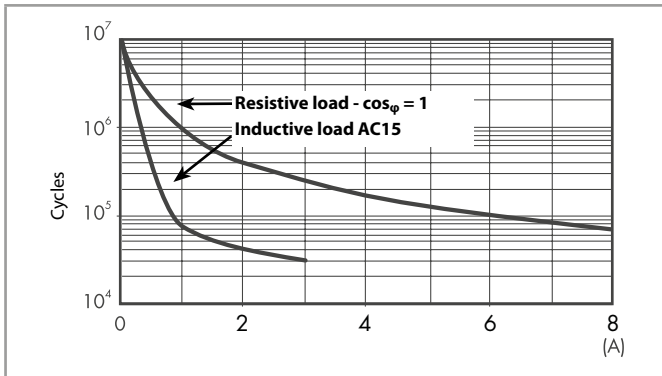

H 50 - Maximum DC1 breaking capacity (type 50.14)

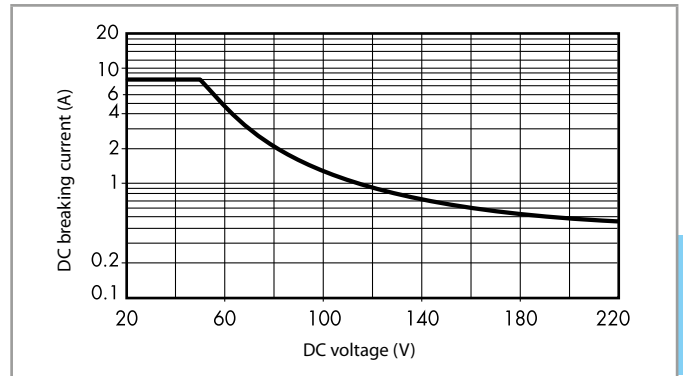

- When switching a resistive load (DC1) having voltage and current values under the curve, an electrical life of $\geq 100 \cdot 10^3$ can be expected.
 - In the case of DC13 loads, the connection of a diode in parallel with the load will permit a similar electrical life as for a DC1 load.
- Note: the release time for the load will be increased.

F 50 - Electrical life (AC) v contact current (type 50.16)

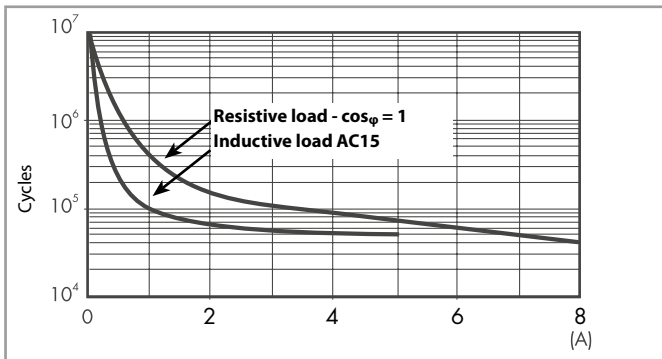

H 50 - Maximum DC1 breaking capacity (type 50.16)

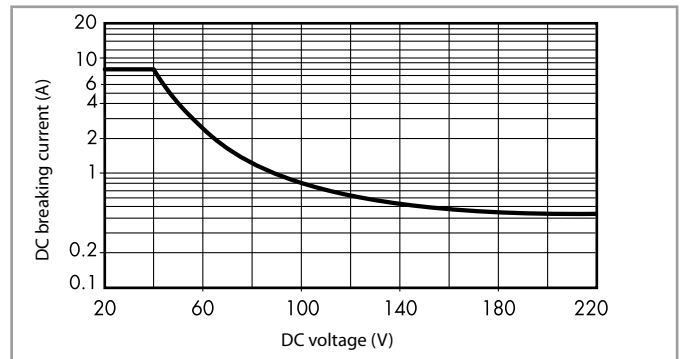

- When switching a resistive load (DC1) having voltage and current values under the curve, an electrical life of $\geq 100 \cdot 10^3$ can be expected.
 - In the case of DC13 loads, the connection of a diode in parallel with the load will permit a similar electrical life as for a DC1 load.
- Note: the release time for the load will be increased.

Outline drawings

Type 50.12...1000/50.12...5000

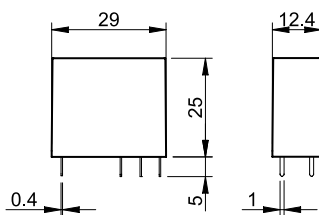

Type 50.14

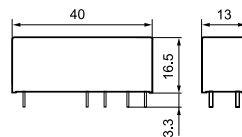

Type 50.16

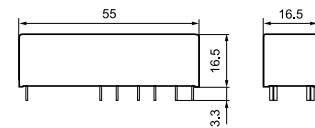



finder[®]
SWITCH TO THE FUTURE

7S
SERIES

Relay module with forcibly guided contacts 6 - 10 A



Disabled lift



Hoists and cranes



Wood-processing machines



Carousel warehouses



Escalators



Elevators and lifts



Industrial robots



Automatic car-washes



Relay module with forcibly guided contacts

Type 7S.12/32

- 2 pole 6 A (1 NO + 1 NC)

Type 7S.14/34

- 4 pole 6 A (2 NO + 2 NC and 3 NO + 1 NC)

Type 7S.16/36

- 6 pole 6 A (4 NO + 2 NC)

- For safety applications, with class A forcibly guided contact relays EN 61810-3 (previously EN 50205)
- For application up to SIL 2 evaluated according to EN 62061 (based on EN 61508 series)
- For functional reliability in machinery and plant engineering according to EN 13849-1
- For railway applications; materials compliant with fire and smoke characteristics EN 45545; mechanical and climatic characteristics compliant with EN 61373 and EN 50155
- DC and AC supply versions
- 24 and 110 V DC versions with extended operating range (0.7...1.25)U_N
- Coil status visual indication with LED
- 35 mm rail (EN 60715) mount

Screwless terminal

Screw terminal



For outline drawing see page 10

7S.12/32...5110 NEW



• 2 pole (1 NO + 1 NC)

7S.14/34...4xx0 NEW



• 4 pole :
(2 NO + 2 NC) type
7S.xxxxx.4220
(3 NO + 1 NC) type
7S.xxxxx.4310

7S.16/36...5420 NEW



• 6 pole (4 NO + 2 NC)

Contact specification				
Contact configuration		1 NO + 1 NC	2 NO + 2 NC, 3 NO + 1 NC	4 NO + 2 NC
Rated current/Max. peak current	A	6/15	6/15	6/15
Rated switching voltage	V AC (50/60 Hz)	250	250	250
Rated load AC1	VA	1500	1500	1500
Rated load AC15 (230 V AC)	VA	700	700	700
Breaking capacity DC1: 30/110/220 V	A	6/0.6/0.2	6/0.9/0.3	6/0.9/0.3
Breaking capacity DC13: 24 V	A	1	3	5
Minimum switching load	mW (V/mA)	60 (5/5)	60 (5/10)	60 (5/10)
Standard contact material		AgNi + Au	AgSnO ₂	AgSnO ₂ +Au
Coil specification				
Nominal voltage (U _N)	V AC (50/60 Hz)	110...125 - 230...240	110...125 - 230...240	110...125 - 230...240
	V DC	12 - 24	12 - 24 - 110	12 - 24 - 110
Rated power	VA (50 Hz)/W	2.3/1	2.3/1	2.3/1
Operating range	AC	(0.85...1.1)U _N	(0.85...1.1)U _N	(0.85...1.1)U _N
	DC	(0.8...1.2)U _N	(0.8...1.2)U _N	(0.8...1.2)U _N
	DC extended range (24 and 110 V only)	(0.7...1.25)U _N	(0.7...1.25)U _N	(0.7...1.25)U _N
Holding voltage	AC/DC	0.45 U _N / 0.45 U _N	0.55 U _N / 0.55 U _N	0.55 U _N / 0.55 U _N
Must drop-out voltage	AC/DC	0.1 U _N / 0.1 U _N	0.1 U _N / 0.1 U _N	0.1 U _N / 0.1 U _N
Technical data				
Mechanical life	cycles	10 · 10 ⁶	10 · 10 ⁶	10 · 10 ⁶
Electrical life at rated load AC1	cycles	100 · 10 ³	100 · 10 ³	100 · 10 ³
Operate/release time	ms	7/11	12/10	12/10
Insulation between coil and contacts (1.2/50 μs)	kV	6	6	6
Dielectric strength between open contacts	V AC	1500	1500	1500
Ambient temperature	°C	-40...+70	-40...+70	-40...+70
Protection category		IP 20	IP 20	IP 20
Approvals (according to type)				

Relay module with forcibly guided contacts

Type 7S.23

- 3 pole (2 NO + 1 NC)

- For safety applications, with class A forcibly guided contact relays EN 61810-3 (previously EN 50205)
- For application up to SIL 2 evaluated according to EN 62061 (based on EN 61508 series)
- For functional reliability in machinery and plant engineering according to EN 13849-1
- DC coil
- Camium free contacts
- 17.5 mm wide
- Coil status visual indication with LED
- 35 mm rail (EN 60715) mount

Screw terminal



NEW 7S.23



- 3 pole (2 NO + 1 NC)

For outline drawing see page 10

Contact specification

Contact configuration		2 NO + 1 NC
Rated current/Max. peak current	A	10/20
Rated switching voltage	V AC (50/60 Hz)	250
Rated load AC1	VA	2500
Rated load AC15 (230 V AC)	VA	500
Breaking capacity DC1: 30/110/220 V	A	6/0.6/0.2
Breaking capacity DC13: 24 V	A	1
Minimum switching load	mW (V/mA)	60 (5/5)
Standard contact material		AgNi + Au

Coil specification

Nominal voltage (U _N)	V DC	12 - 24 - 48 - 110
Rated power	VA (50 Hz)/W	2.3/1
Operating range	DC	(0.8...1.2)U _N
Holding voltage	DC	0.45 U _N
Must drop-out voltage	DC	0.1 U _N

Technical data

Mechanical life	cycles	10 · 10 ⁶
Electrical life at rated load AC1	cycles	100 · 10 ³
Operate/release time	ms	7/11
Insulation between coil and contacts (1.2/50 μs)	kV	6
Dielectric strength between open contacts	V AC	1500
Ambient temperature	°C	-40...+70
Protection category		IP 20

Approvals (according to type)



Ordering information

Example: 7S series Relay module with forcibly guided contacts, 6 contact (4 NO + 2 NC) 6 A, supply voltage 24 V DC.

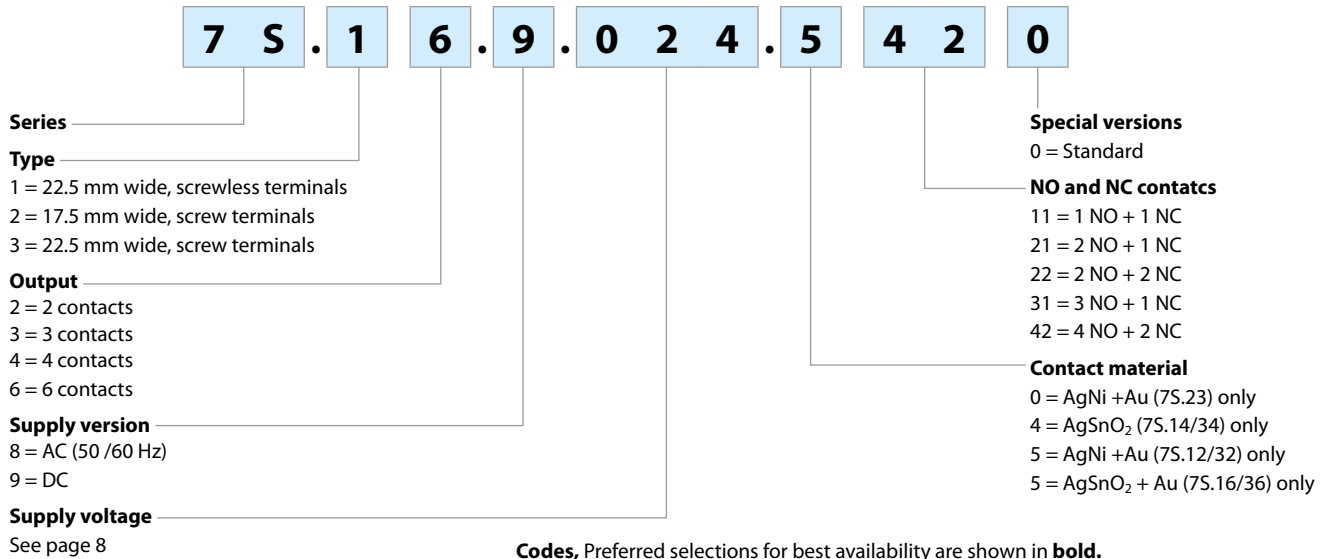

Codes, Preferred selections for best availability are shown in **bold**.

7S.12.9.012.5110	7S.14.9.012.4220	7S.16.9.012.5420
7S.12.9.024.5110	7S.14.9.012.4310	7S.16.9.024.5420
7S.12.8.120.5110	7S.14.9.024.4220	7S.16.9.110.5420
7S.12.8.230.5110	7S.14.9.024.4310	7S.16.8.120.5420
	7S.14.9.110.4220	7S.16.8.230.5420
7S.32.9.012.5110	7S.14.9.110.4310	
7S.32.9.024.5110	7S.14.8.120.4220	7S.36.9.012.5420
7S.32.8.120.5110	7S.14.8.120.4310	7S.36.9.024.5420
7S.32.8.230.5110	7S.14.8.230.4220	7S.36.9.110.5420
	7S.14.8.230.4310	7S.36.8.120.5420
		7S.36.8.230.5420
	7S.34.9.012.4220	
	7S.34.9.012.4310	7S.23.9.012.0210
	7S.34.9.024.4220	7S.23.9.024.0210
	7S.34.9.024.4310	7S.23.9.048.0210
	7S.34.9.110.4220	7S.23.9.110.0210
	7S.34.9.110.4310	
	7S.34.8.120.4220	
	7S.34.8.120.4310	
	7S.34.8.230.4220	
	7S.34.8.230.4310	

Technical data

Insulation according to EN 61810-1

Nominal voltage of supply system	V AC	230/400
Rated insulation voltage	V AC	250
Pollution degree		2

Insulation between coil and contact set

Type of Insulation		Reinforced
Overvoltage category		III
Rated impulse voltage	kV (1.2/50 μ s)	6
Dielectric strength	V AC	4000

Insulation between adjacent contacts

Type of Insulation		Basic
Overvoltage category		III
Rated impulse voltage	kV (1.2/50 μ s)	4
Dielectric strength	V AC	2500

Insulation between open contacts

Type of disconnection		Micro-disconnection
Dielectric strength	V AC/kV (1.2/50 μ s)	1500/2.5

Insulation between coil terminals

Rated impulse voltage (surge) differential mode (according to EN 61000-4-5)	kV(1.2/50 μ s)	1.5
--	--------------------	-----

Terminals

Min. wire size		Screw Terminal		Screwless Terminal	
		solid cable	stranded cable	solid cable	stranded cable
	mm ²	0.5	0.5	0.5	0.5
	AWG	21	21	21	21
Max. wire size		Screw Terminal		Screwless Terminal	
		solid cable	stranded cable	solid cable	stranded cable
	mm ²	1 x 6 / 2 x 2.5	1 x 4 / 2 x 2.5	1 x 1.5	1 x 1.5
	AWG	1 x 10 / 2 x 14	1 x 12 / 2 x 14	1 x 14	1 x 16
Wire strip length	mm	9			

Other data

		7S.12/32	7S.14/34	7S.16/36	7S.23
Bounce time: NO/NC	ms	2/8	2/10	2/10	2/15
Vibration resistance (10...200)Hz: NO/NC	g	10/5	20/6	20/6	10/2
Shock resistance: NO/NC	g	20/6	20/5	20/5	20/6
Power lost to the environment	without contact current	W	0.8	0.8	0.8
	with rated current	W	1.4	2.3	1.4

Contact specifications

Contact diagrams

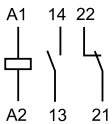
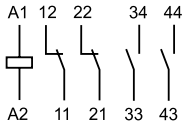
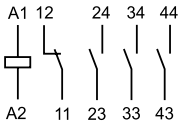
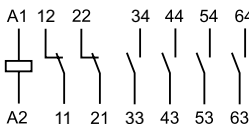
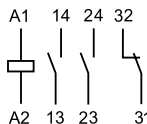
7S.12/7S.32	7S.14/34...4220	7S.14...4310	7S.16/36...5420	7S.23																																																																																																								
 <p>A1 14 22 A2 13 21</p>	 <p>A1 12 22 34 44 A2 11 21 33 43</p>	 <p>A1 12 24 34 44 A2 11 23 33 43</p>	 <p>A1 12 22 34 44 54 64 A2 11 21 33 43 53 63</p>	 <p>A1 14 24 32 A2 13 23 31</p>																																																																																																								
<table border="1" data-bbox="108 1883 228 2078"> <tr><td>21</td><td>22</td><td>14</td><td>13</td></tr> <tr><td> </td><td> </td><td> </td><td> </td></tr> <tr><td> </td><td> </td><td> </td><td> </td></tr> <tr><td> </td><td> </td><td> </td><td> </td></tr> <tr><td>A1</td><td>A1</td><td>A2</td><td>A2</td></tr> </table>	21	22	14	13													A1	A1	A2	A2	<table border="1" data-bbox="331 1883 451 2078"> <tr><td>43</td><td>44</td><td>21</td><td>22</td></tr> <tr><td> </td><td> </td><td> </td><td> </td></tr> <tr><td> </td><td> </td><td> </td><td> </td></tr> <tr><td> </td><td> </td><td> </td><td> </td></tr> <tr><td>33</td><td>34</td><td>11</td><td>12</td></tr> <tr><td>A1</td><td>A1</td><td>A2</td><td>A2</td></tr> </table>	43	44	21	22													33	34	11	12	A1	A1	A2	A2	<table border="1" data-bbox="608 1883 727 2078"> <tr><td>43</td><td>44</td><td>23</td><td>24</td></tr> <tr><td> </td><td> </td><td> </td><td> </td></tr> <tr><td> </td><td> </td><td> </td><td> </td></tr> <tr><td> </td><td> </td><td> </td><td> </td></tr> <tr><td>33</td><td>34</td><td>11</td><td>12</td></tr> <tr><td>A1</td><td>A1</td><td>A2</td><td>A2</td></tr> </table>	43	44	23	24													33	34	11	12	A1	A1	A2	A2	<table border="1" data-bbox="914 1883 1034 2078"> <tr><td>21</td><td>22</td><td>11</td><td>12</td></tr> <tr><td>63</td><td>64</td><td>43</td><td>44</td></tr> <tr><td> </td><td> </td><td> </td><td> </td></tr> <tr><td> </td><td> </td><td> </td><td> </td></tr> <tr><td>53</td><td>54</td><td>33</td><td>34</td></tr> <tr><td>A1</td><td>A1</td><td>A2</td><td>A2</td></tr> </table>	21	22	11	12	63	64	43	44									53	54	33	34	A1	A1	A2	A2	<table border="1" data-bbox="1262 1883 1321 2078"> <tr><td>23</td><td>24</td></tr> <tr><td>13</td><td>14</td></tr> <tr><td> </td><td> </td></tr> <tr><td> </td><td> </td></tr> <tr><td>A1</td><td>A2</td></tr> <tr><td>31</td><td>32</td></tr> </table>	23	24	13	14					A1	A2	31	32
21	22	14	13																																																																																																									
A1	A1	A2	A2																																																																																																									
43	44	21	22																																																																																																									
33	34	11	12																																																																																																									
A1	A1	A2	A2																																																																																																									
43	44	23	24																																																																																																									
33	34	11	12																																																																																																									
A1	A1	A2	A2																																																																																																									
21	22	11	12																																																																																																									
63	64	43	44																																																																																																									
53	54	33	34																																																																																																									
A1	A1	A2	A2																																																																																																									
23	24																																																																																																											
13	14																																																																																																											
A1	A2																																																																																																											
31	32																																																																																																											

F 7S12 - Electrical life (AC) v contact current - 7S.12

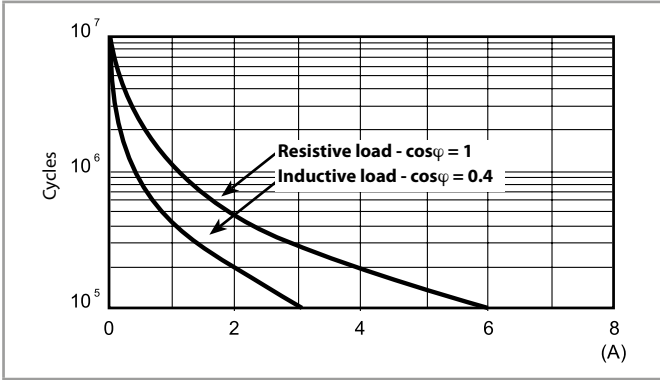

H 7S12* - Maximum DC breaking capacity - 7S.12

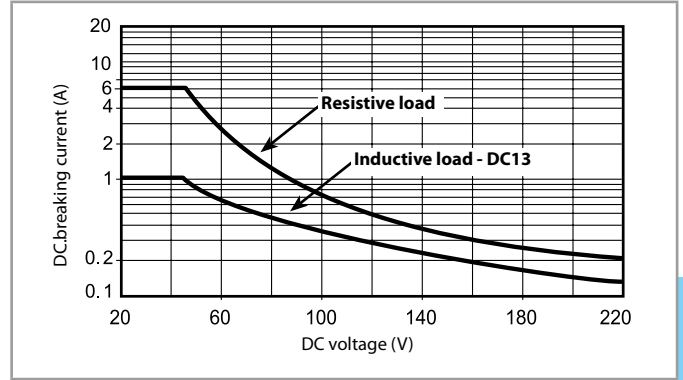

F 7S14 - Electrical life (AC) v contact current - 7S.14/34

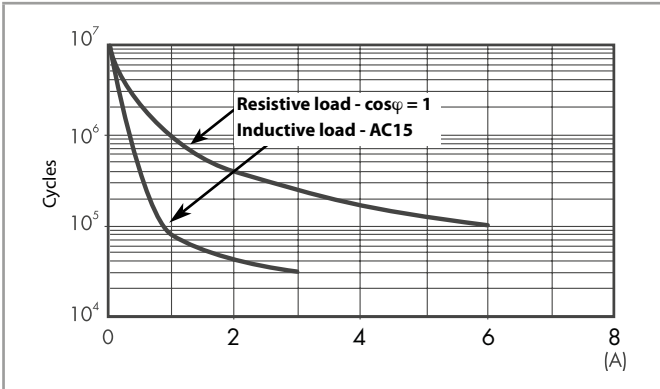

H 7S14* - Maximum DC breaking capacity - 7S.14/34

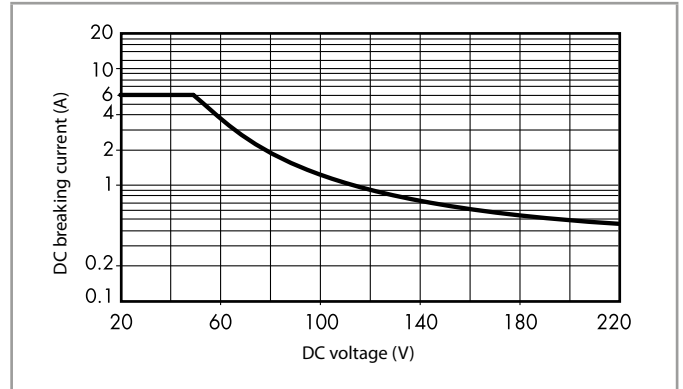

F 7S16 - Electrical life (AC) v contact current - 7S.16/36

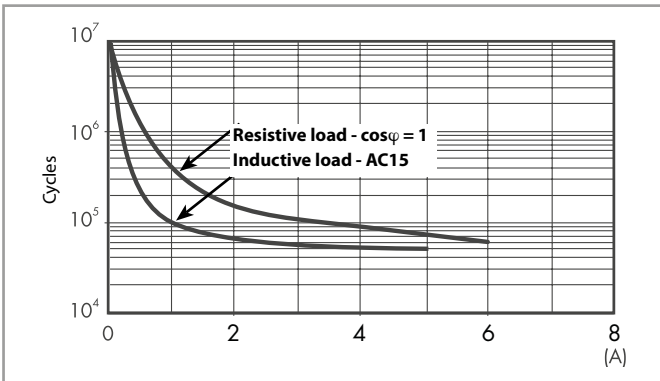

H 7S16* - Maximum DC breaking capacity - 7S.16/36

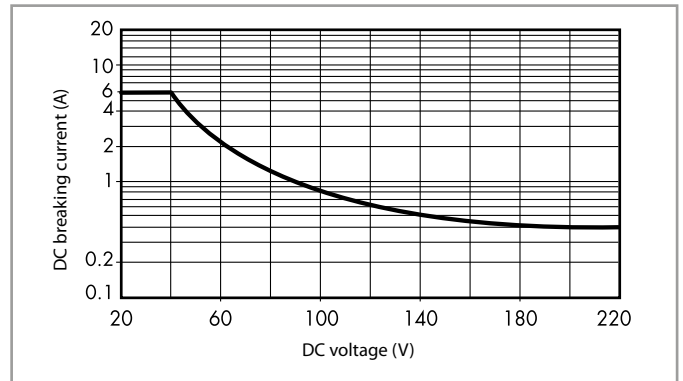

F 7S23 - Electrical life (AC) v contact current - 7S.23

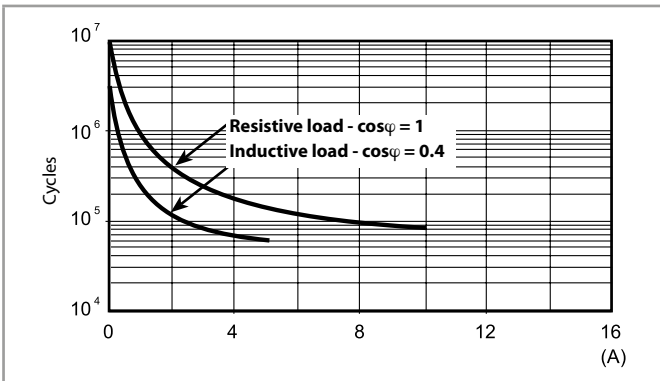

H 7S23* - Maximum DC breaking capacity - 7S.23

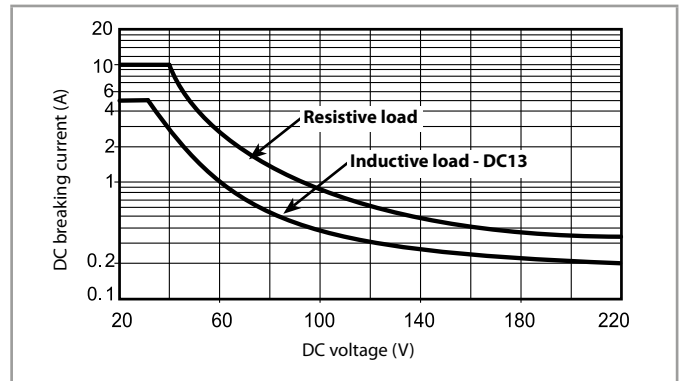

*When switching a load having voltage and current values under the curve, an electrical life of $\geq 100 \cdot 10^3$ can be expected.

Coil specifications

DC coil data - type 7S.12/32

Nominal voltage	Coil code	Operating range		Rated input current at U_N	Rated power at U_N
		U_{min}	U_{max}		
U_N		V	V	I_N	W
V		V	V	mA	W
12	9.012	9.6	14.4	55	0.7
24	9.024	16.8	30	38.2	0.9

AC coil data - type 7S.12/32

Nominal voltage	Coil code	Operating range		Rated input current at U_N	Rated power at U_N
		U_{min}	U_{max}		
U_N		V	V	I_N	VA/W
V		V	V	mA	VA/W
110...125	8.120	93	138	9.8	1.2/1.1
230...240	8.230	195	264	11.8	2.8/1.2

DC coil data - type 7S.14/34 / 7S.16/36

Nominal voltage	Coil code	Operating range		Rated input current at U_N	Rated power at U_N
		U_{min}	U_{max}		
U_N		V	V	I_N	W
V		V	V	mA	W
12	9.012	9.6	14.4	64.7	0.8
24	9.024	16.8	30	42.2	1
110	9.110	77	138	11.6	1.4

AC coil data - type 7S.14/34 / 7S.16/36

Nominal voltage	Coil code	Operating range		Rated input current at U_N	Rated power at U_N
		U_{min}	U_{max}		
U_N		V	V	I_N	VA/W
V		V	V	mA	VA/W
110...125	8.120	93	138	10.2	1.3/1.1
230...240	8.230	195	264	11.8	2.9/1.2

DC coil data - type 7S.23

Nominal voltage	Coil code	Operating range		Rated input current at U_N	Rated power at U_N
		U_{min}	U_{max}		
U_N		V	V	I_N	W
V		V	V	mA	W
12	9.012	9.6	14.4	47.1	0.6
24	9.024	16.8	30	26.6	0.6
48	9.048	33.6	60	16.2	0.8
110	9.110	77	138	8.8	1

R 7S - DC coil operating range v ambient temperature - 7S.12/32 / 7S.23 / 7S.14/34 / 7S.16/36

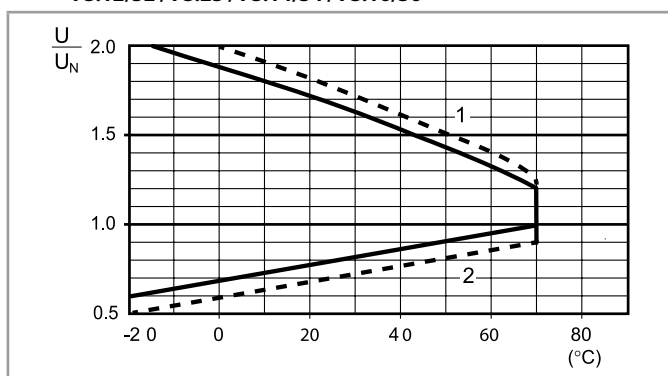

- 1 - Max. permitted coil voltage.
- 2 - Min. pick-up voltage with coil at ambient temperature.
- 24 and 110 V DC coils only (extended range)

R 7S - AC coil operating range v ambient temperature - 7S.12/32 / 7S.23 / 7S.14/34 / 7S.16/36

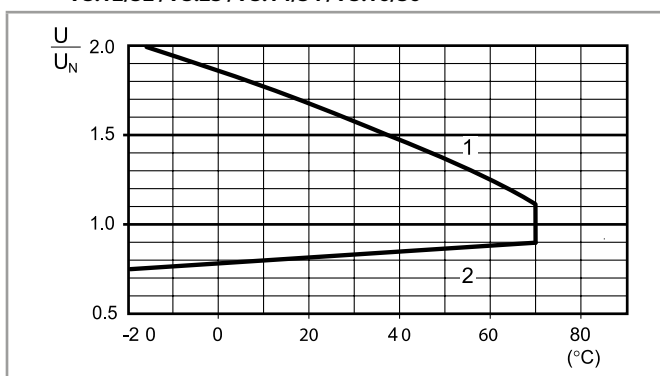

- 1 - Max. permitted coil voltage.
- 2 - Min. pick-up voltage with coil at ambient temperature.

Example wiring diagrams

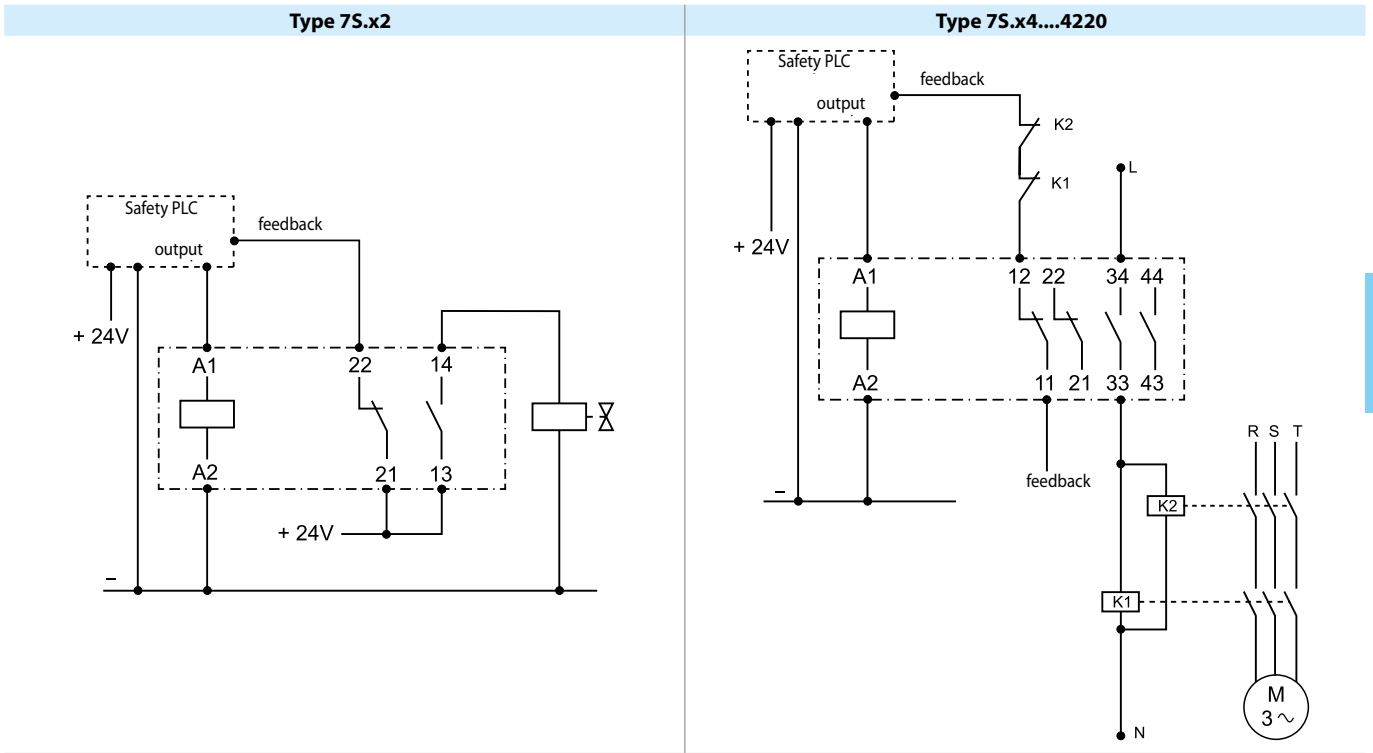

Outline drawings

75.12/14/16
Screwless terminal

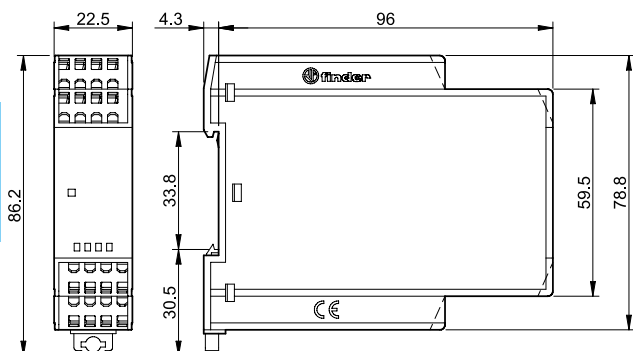

75.23
Screw terminal

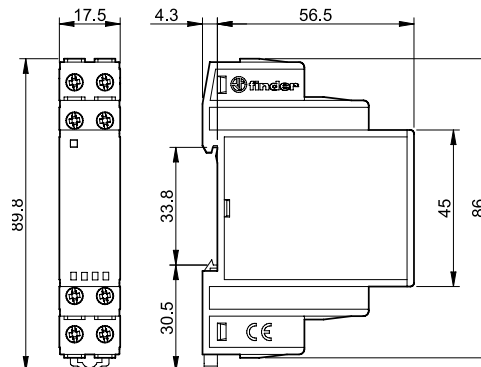

75.32
Screw terminal

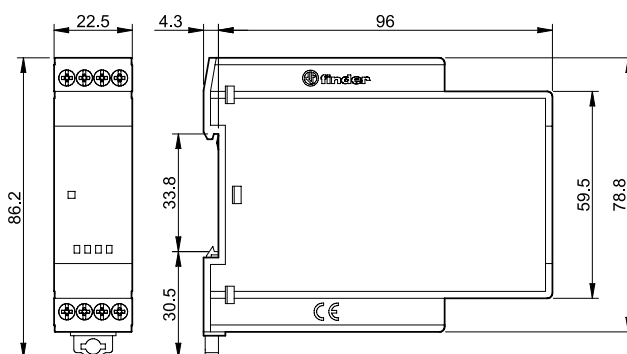

75.34
Screw terminal

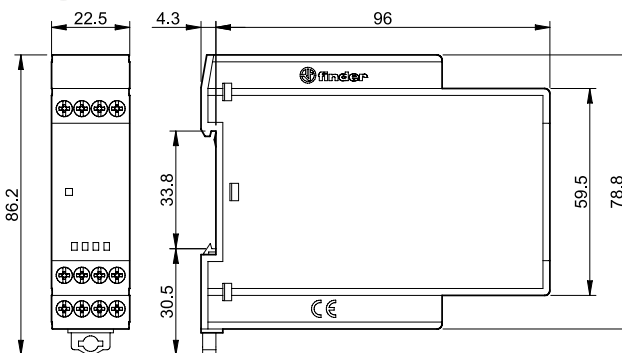

75.36
Screw terminal

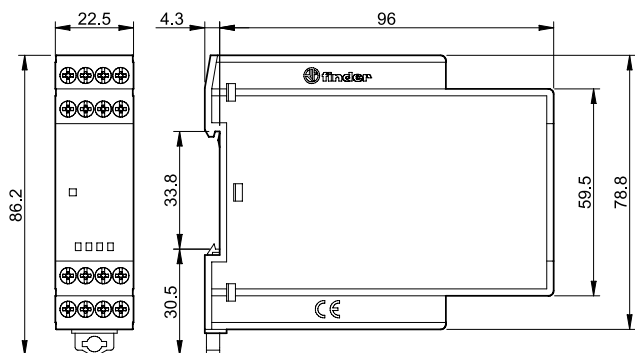

Accessories

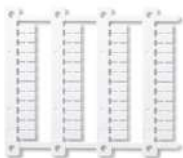

060.48

Sheet of marker tags, plastic, 48 tags, 6 x 12 mm, for CEMBRE thermal transfer printers

060.48



finder[®]
SWITCH TO THE FUTURE

Modular Solid State Relay 5 - 15 - 30 - 50 A

77
SERIES



Drying kilns



Heating and
cooling



Lighting control
in corridors (for
hotels, offices
and hospitals)



Bottling plant



Labelling
machines



Packaging
machines



5 A modular SSR, 1 NO AC output

- 17.5 mm housing
- 60 to 240 V AC output (with back to back SCR)
- 5 kV (1.2/50 μs) insulation between Input and Output
- Zero-crossing and random switch-on versions available
- High switching speed
- High endurance
- Silent switching
- Spark and bounce-free switching
- Low control power
- 3-phase general purpose
- 35 mm rail (EN 60715) mount

77.01

Screw terminal



* See L77-3 diagram page 13

** See L77-1 and L77-2 diagrams page 12

For outline drawing see page 16

Output specification

Output configuration	77.01.x.xxx.8050		77.01.x.xxx.8051	
Output configuration	1 NO (SPST-NO)		1 NO (SPST-NO)	
Rated current I _N /Max. peak current* (10 ms)	A 5/300*		A 5/300*	
Rated voltage	V AC (50/60 Hz) 230		V AC (50/60 Hz) 230	
Switching voltage range	V AC (50/60 Hz) 48...265		V AC (50/60 Hz) 48...265	
Repetitive peak off-state voltage	V _{pk} 800		V _{pk} 800	
Rated load AC7a (cos φ = 0.8)	A 5		A 5	
Rated load AC15	A 5		A 3	
Single phase motor rating (230 V AC)	kW —		kW 0.1	
Nominal lamp rating:				
230 V incandescent/halogen W	1000		800	
fluorescent tubes with electronic ballast W	1000		800	
fluorescent tubes with electromechanical ballast W	1000		800	
CFL W	800		400	
230 V LED W	800		400	
LV halogen or LED with electronic ballast W	800		400	
LV halogen or LED with electromechanical ballast W	1000		800	
Minimum switching current @ 230 V	mA 100		mA 100	
Typical "OFF-state" leakage current @ 230 V	mA 0.5		mA 3.5	
Max "ON-state" voltage drop @ 25 °C and 5 A/100 mA	V 0.85/1.5		V 0.85/1.5	
Power loss @ 5 A	W 4		W 4	

Input specification

Nominal voltage (U _N)	V AC (50/60 Hz)	24	230	24	230
	V DC	12...24	—	12...24	—
Rated power	VA (50 Hz)/W	0.6/0.5	3.6/0.3	0.6/0.5	3.6/0.3
Operating range	V AC (50/60 Hz)	16...32	90...265	16...32	90...265
	V DC	9.8...32	—	9.8...32	—
Must drop-out voltage	V AC (50/60 Hz)/DC	2.4	24	2.4	24

Technical data

Electrical life	cycles	10 · 10 ⁶		10 · 10 ⁶	
Operate/release time	ms	20/12		9/8	
Insulation between input and output (1.2/50 μs)	kV	5		5	
Ambient temperature	°C	-20...+70**		-20...+70**	
Protection category		IP 20		IP 20	

Approvals (according to type)



77.01.x.xxx.8050



Zero-crossing switch-on Suggested applications:

- Lamp inrush current reduction (CFL - Compact Fluorescent energy-saving Lamps and similar)
- Heater control
- Solenoid, contactor driver

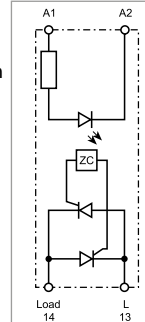

77.01.x.xxx.8051



Random switch-on Suggested applications:

- Finer control requiring short operate time (specially motor control)
- AC Input phase different from AC Output phase

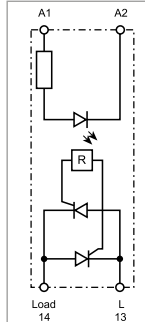

7 - 15 A modular SSR, 1 NO DC output

- 17.5 mm housing
- 2 versions, for 24 and 125 V DC mosfet output
- 4 kV (1.2/50 μ s) insulation between Input and Output
- Short circuit protection
- High switching speed
- High endurance
- Silent switching
- Spark and bounce-free switching
- Low control power
- Suitable for railway applications
- 35 mm rail (EN 60715) mount

77.01

Screw terminal



* See L77-12 and L77-13 diagrams page 10

For outline drawing see page 16

Output specification

Output configuration		1 NO (SPST-NO)	1 NO (SPST-NO)
Rated current I_N /Max. peak current (10 ms)	A	15/160	7/60
Rated voltage	V DC	24	125
Switching voltage range	V DC	16...32	43...140
Rated load DC13	A	5	2.5
DC motor rating	kW	0.2	—
Minimum switching current	mA	100	50
Typical "OFF-state" leakage current	mA	3	6
Max "ON-state" voltage drop @ 25 °C and I_N	V	0.06	0.2
Power loss @ I_N	W	1	1.5
Input specification			
Nominal voltage (U_N)	V DC	6...24	6...24
Rated power	W	0.5	0.5
Operating range	V DC	4...36	4...36
Must drop-out voltage	V DC	3	3
Technical data			
Electrical life	cycles	$10 \cdot 10^6$	$10 \cdot 10^6$
Operate/release time	ms	0.05/2	0.05/2
Insulation between input and output (1.2/50 μ s)	kV	4	4
Ambient temperature	°C	-20...+70*	-20...+70*
Protection category		IP 20	IP 20

Approvals (according to type)

**77.01.9.024.9024****24 V DC output switching
15 A rated****Applications in Energy,
Automation and Machines:**

- Control of electric, pneumatic and hydraulic electromagnetic valves
- Direct control of loads such as motors and electromagnets

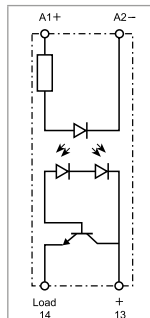
Simplified
circuit diagram**77.01.9.024.9125****110...125 V DC output
switching
7 A rated****Applications in Energy,
Automation and Machines:**

- Control of electric, pneumatic and hydraulic electromagnetic valves
- Direct control of loads such as motors and electromagnets

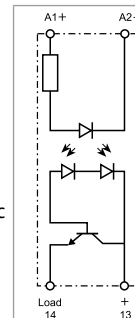
Simplified
circuit diagram

15 A modular SSR, 1 NO output

- 22.5 mm housing, heat-sink + plastic cover
- 24 to 277 V AC output (with triac)
- 6 kV (1.2/50 μ s) insulation between Input and Output
- Zero-crossing and random switch-on versions available
- High switching speed
- High endurance
- Silent switching
- Spark and bounce-free switching
- Low control power
- 3-phase general purpose
- "Relay-style" terminal arrangement (input and output terminals on opposite sides)
- 35 mm rail (EN 60715) mount

77.11
Screw terminal



* See L77-7 diagram page 13

** See L77-6 diagrams page 12

For outline drawing see page 16

Output specification

Output configuration	1 NO (SPST-NO)		1 NO (SPST-NO)	
Rated current I_N /Max. peak current* (10 ms) A	15/400*		15/400*	
Rated voltage V AC (50/60 Hz)	230		230	
Switching voltage range V AC (50/60 Hz)	19...305		19...305	
Repetitive peak off-state voltage V_{pk}	800		800	
Rated load AC7a (cos φ = 0.8, @ 25 °C) A	20		20	
Rated load AC15 A	15		15	
Single phase motor rating (230 V AC) kW	—		0.75	
Nominal lamp rating:				
230 V incandescent/halogen W	4000		2500	
fluorescent tubes with electronic ballast W	4000		2500	
fluorescent tubes with electromechanical ballast W	2000		1000	
CFL W	3000		1500	
230 V LED W	3000		1500	
LV halogen or LED with electronic ballast W	3000		1500	
LV halogen or LED with electromechanical ballast W	3000		1500	
Minimum switching current @ 250 V mA	100		100	
Typical "OFF-state" leakage current @ 250 V mA	1		1	
Max "ON-state" voltage drop @ 25 °C and 15 A V	1.55		1.55	
Power loss @ 15 A W	14		14	

Input specification

Nominal voltage (U_N)	V AC (50/60 Hz)	—	230	—	230
	V DC	24	—	24	—
Rated power VA (50 Hz)/W		0.4	7.5/0.9	0.4	7.5/0.9
Operating range	V AC (50/60 Hz)	—	40...305	—	40...305
	V DC	4...32	—	4...32	—
Must drop-out voltage V AC (50/60 Hz)/DC		—/2	6/—	—/2	6/—

Technical data

Electrical life cycles		10 · 10 ⁶		10 · 10 ⁶	
Operate/release time ms		< 10/< 10	< 10/< 30	< 1/< 10	< 2/< 25
Insulation between input and output (1.2/50 μ s) kV		6		6	
Ambient temperature °C		-20...+80**		-20...+80**	
Protection category		IP 20		IP 20	

Approvals (according to type)



77.11.x.xxx.8250



Zero-crossing switch-on

Suggested applications:

- Lamp inrush current reduction (CFL - Compact Fluorescent energy-saving Lamps and similar)
- Heater control
- Solenoid, contactor driver

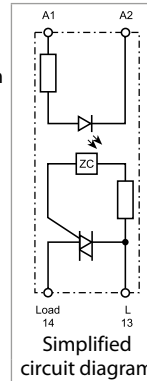

77.11.x.xxx.8251



Random switch-on

Suggested applications:

- Fine controls involving shorter time (specially motor control)

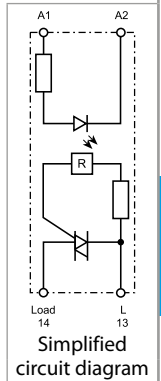

30 A modular SSR, 1 NO output

- 22.5 mm housing, heat-sink + plastic cover
- 60 to 440 V AC output (with back to back SCR)
- 6 kV (1.2/50 μ s) insulation between Input and Output
- Zero-crossing and random switch-on versions available
- High switching speed
- High endurance
- Silent switching
- Spark and bounce-free switching
- Low control power
- 3-phase general purpose
- "Relay-style" terminal arrangement (input and output terminals on opposite sides)
- 35 mm rail (EN 60715) mount

77.31

Screw terminal



* See L77-5 diagram page 13

** See L77-4 diagrams page 12

For outline drawing see page 16

Output specification

Output configuration	1 NO (SPST-NO)		1 NO (SPST-NO)	
Rated current I_N /Max. peak current* (10 ms) A	30/520*		30/520*	
Rated voltage V AC (50/60 Hz)	400		400	
Switching voltage range V AC (50/60 Hz)	48...480		48...480	
Repetitive peak off-state voltage V_{pk}	1100		1100	
Rated load AC7a (cos φ = 0.8) A	30		30	
Rated load AC15 A	20		20	
Single phase motor rating (230 V AC) kW	—		1.5	
Nominal lamp rating:				
230 V incandescent/halogen W	6000		4500	
fluorescent tubes with electronic ballast W	6000		4000	
fluorescent tubes with electromechanical ballast W	3000		1800	
CFL W	4000		2500	
230 V LED W	4000		2500	
LV halogen or LED with electronic ballast W	4000		2500	
LV halogen or LED with electromechanical ballast W	4000		2500	
Minimum switching current @ 400 V mA	300		300	
Typical "OFF-state" leakage current @ 400 V mA	1		1	
Max "ON-state" voltage drop @ 25 °C and 30 A V	0.85		0.85	
Power loss @ 30 A W	16		16	

Input specification

Nominal voltage (U_N)	V AC (50/60 Hz)	—	230	—	230
	V DC	24	—	24	—
Rated power @ U_{MAX}	VA (50 Hz)/W	0.4	7.5/0.9	0.4	7.5/0.9
Operating range	V AC (50/60 Hz)	—	40...280	—	40...280
	V DC	4...32	—	4...32	—
Must drop-out voltage	V AC (50/60 Hz)/DC	—/2	6/—	—/2	6/—

Technical data

Electrical life	cycles	10 · 10 ⁶		10 · 10 ⁶	
Operate/release time	ms	< 10/< 10	< 10/< 30	< 1/< 10	< 2/< 25
Insulation between input and output (1.2/50 μ s)	kV	6		6	
Ambient temperature	°C	-20...+80**		-20...+80**	
Protection category		IP 20		IP 20	

Approvals (according to type)**77.31.x.xxx.8050****Zero-crossing switch-on**
Suggested applications:

- Lamp inrush current reduction (CFL - Compact Fluorescent energy-saving Lamps and similar)
- Heater control
- Solenoid, contactor driver

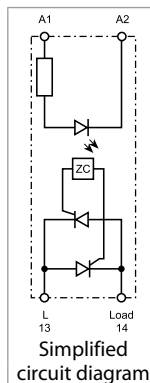
**77.31.x.xxx.8051****Random switch-on****Suggested applications:**

- Finer control requiring short operate time (specially motor control)

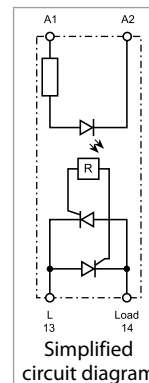

30 A modular SSR, 1 NO output

- 22.5 mm housing, heat-sink + plastic cover
- 60 to 440 V AC output (with back to back SCR)
- 6 kV (1.2/50 µs) insulation between Input and Output
- Zero-crossing and random switch-on versions available
- High switching speed
- High endurance
- Silent switching
- Spark and bounce-free switching
- Low control power
- 3-phase general purpose
- "Contactor-style" terminal arrangement (input and output terminals on adjacent sides)
- 35 mm rail (EN 60715) mount

77.31
Screw terminal



* See L77-5 diagram page 13
** See L77-4 diagrams page 12

For outline drawing see page 16

Output specification

Output configuration	1 NO (SPST-NO)		1 NO (SPST-NO)	
Rated current I_N /Max. peak current* (10 ms) A	30/520*		30/520*	
Rated voltage V AC (50/60 Hz)	400		400	
Switching voltage range V AC (50/60 Hz)	48...480		48...480	
Repetitive peak off-state voltage V_{pk}	1100		1100	
Rated load AC7a (cos φ = 0.8) A	30		30	
Rated load AC15 A	20		20	
Single phase motor rating (230 V AC) kW	—		1.5	
Nominal lamp rating:				
230 V incandescent/halogen W	6000		4500	
fluorescent tubes with electronic ballast W	6000		4000	
fluorescent tubes with electromechanical ballast W	3000		1800	
CFL W	4000		2500	
230 V LED W	4000		2500	
LV halogen or LED with electronic ballast W	4000		2500	
LV halogen or LED with electromechanical ballast W	4000		2500	
Minimum switching current @ 400 V mA	300		300	
Typical "OFF-state" leakage current @ 400 V mA	1		1	
Max "ON-state" voltage drop @ 25 °C and 30 A V	0.85		0.85	
Power loss @ 30 A W	16		16	

Input specification

Nominal voltage (U_N)	V AC (50/60 Hz)	—	230	—	230
	V DC	24	—	24	—
Rated power VA (50 Hz)/W		0.4	7.5/0.9	0.4	7.5/0.9
Operating range	V AC (50/60 Hz)	—	40...280	—	40...280
	V DC	4...32	—	4...32	—
Must drop-out voltage V AC (50/60 Hz)/DC		—/2	6/—	—/2	6/—

Technical data

Electrical life cycles		10 · 10 ⁶		10 · 10 ⁶	
Operate/release time ms		< 10/< 10	< 10/< 30	< 1/< 10	< 2/< 25
Insulation between input and output (1.2/50 µs) kV		6		6	
Ambient temperature °C		-20...+80**		-20...+80**	
Protection category		IP 20		IP 20	

Approvals (according to type)



77.31.x.xxx.8070



Zero-crossing switch-on

Suggested applications:

- Lamp inrush current reduction (CFL - Compact Fluorescent energy-saving Lamps and similar)
- Heater control
- Solenoid, contactor driver

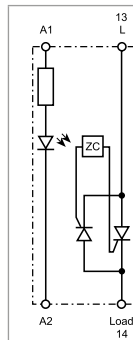

Simplified circuit diagram

77.31.x.xxx.8071



Random switch-on

Suggested applications:

- Fine controls involving shorter time (specially motor control)

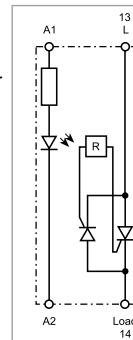

Simplified circuit diagram

25, 40 And 50 A panel SSR, "hockey puck" style

- "hockey puck" housing with cover
- 24 to 240 V AC output
- Zero-crossing version
- High switching speed
- High endurance
- Silent switching
- Spark and bounce-free switching
- Low control power
- 3-phase general purpose
- "Relay-style" terminal arrangement (input and output terminals on opposite sides)
- Mounting on heatsink with screws

77.x5
Screw terminal (plate clamp)



* See L77-11 diagrams page 13
** See L77-8, L77-9 and L77-10 diagrams page 13

For outline drawing see page 16

Output specification

Output configuration	1 NO (SPST-NO)	1 NO (SPST-NO)	1 NO (SPST-NO)
Rated current I_N /Max. peak current* (10 ms) A	25/300*	40/500*	50/520*
Rated voltage V AC (50/60 Hz)	230	230	230
Switching voltage range V AC (50/60 Hz)	21.6...280	21.6...280	21.6...280
Repetitive peak off-state voltage V_{pk}	600	600	600
Nominal lamp rating:			
230 V incandescent/halogen W	2000	4000	6000
fluorescent tubes with electronic ballast W	2000	4000	6000
fluorescent tubes with electromechanical ballast W	1000	2000	3000
CFL W	800	3000	4000
230 V LED W	800	3000	4000
LV halogen or LED with electronic ballast W	800	3000	4000
LV halogen or LED with electromechanical ballast W	1000	3000	4000
Minimum switching current @ 250 V mA	120	250	250
Typical "OFF-state" leakage current @ 250 V mA	10	10	10
Max "ON-state" voltage drop @ 25 °C and I_N V	1.6	1.6	1.6
Power loss @ I_N W	40	64	80

Input specification

Nominal voltage (U_N)	V AC (50/60 Hz)	—	230	—	230	—	230
	V DC	24	—	24	—	24	—
Rated power @ U_{MAX}	VA (50 Hz)/W	—/0.6	2.4/—	—/0.6	2.4/—	—/0.6	2.4/—
Operating range	V AC (50/60 Hz)	—	90...280	—	90...280	—	90...280
	V DC	3...32	—	3...32	—	3...32	—
Must drop-out voltage	V AC (50/60 Hz)/DC	—/1	10/—	—/1	10/—	—/1	10/—

Technical data

Electrical life	cycles	10 · 10 ⁶		10 · 10 ⁶		10 · 10 ⁶	
Operate/release time	ms	10/10	40/80	10/10	40/80	10/10	40/80
Insulation between input and output (1.2/50 μs)	kV	5.6		5.6		5.6	
Ambient temperature	°C	-30...+80**		-30...+80**		-30...+80**	
Protection category		IP 20		IP 20		IP 20	

Approvals (according to type)



77.25.x.xxx.8250



Zero-crossing switch-on

- Output: 25 A/230 V AC
- Suggested applications: heater control

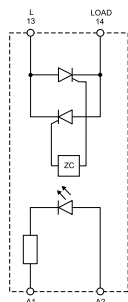

Simplified circuit diagram

77.45.x.xxx.8250



Zero-crossing switch-on

- Output: 40 A/230 V AC
- Suggested applications: heater control

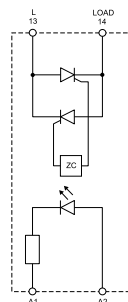

Simplified circuit diagram

77.55.x.xxx.8250



Zero-crossing switch-on

- Output: 50 A/230 V AC
- Suggested applications: heater control

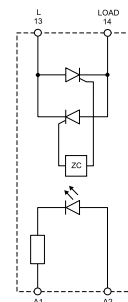

Simplified circuit diagram

25, 40 And 50 A panel SSR, "hockey puck" style

- "hockey puck" housing with cover
- 48 to 600 V AC output
- Zero-crossing version
- High switching speed
- High endurance
- Silent switching
- Spark and bounce-free switching
- Low control power
- 3-phase general purpose
- "Relay-style" terminal arrangement (input and output terminals on opposite sides)
- Mounting on heatsink with screws

77.x5

Screw terminal (plate clamp)



* See L77-11 diagrams page 13

** See L77-8, L77-9 and L77-10 diagrams page 13

For outline drawing see page 16

Output specification

Output configuration	1 NO (SPST-NO)		1 NO (SPST-NO)		1 NO (SPST-NO)	
Rated current I_N /Max. peak current* (10 ms) A	25/300*		40/500*		50/520*	
Rated voltage V AC (50/60 Hz)	600		600		600	
Switching voltage range V AC (50/60 Hz)	43.2...660		43.2...660		43.2...660	
Repetitive peak off-state voltage V_{pk}	1200		1200		1200	
Nominal lamp rating:						
230 V incandescent/halogen W	2000		4000		6000	
fluorescent tubes with electronic ballast W	2000		4000		6000	
fluorescent tubes with electromechanical ballast W	1000		2000		3000	
CFL W	800		3000		4000	
230 V LED W	800		3000		4000	
LV halogen or LED with electronic ballast W	800		3000		4000	
LV halogen or LED with electromechanical ballast W	1000		3000		4000	
Minimum switching current @ 250 V mA	120		250		250	
Typical "OFF-state" leakage current @ 250 V mA	10		10		10	
Max "ON-state" voltage drop @ 25 °C and I_N V	1.6		1.6		1.6	
Power loss @ I_N W	40		64		80	

Input specification

Nominal voltage (U_N)	V AC (50/60 Hz)	—	230	—	230	—	230
	V DC	24	—	24	—	24	—
Rated power @ U_{MAX}	VA (50 Hz)/W	—/0.6	2.4/—	—/0.6	2.4/—	—/0.6	2.4/—
	Operating range V AC (50/60 Hz)	—	90...280	—	90...280	—	90...280
Must drop-out voltage	V DC	4...32	—	4...32	—	4...32	—
	V AC (50/60 Hz)/DC	—/1	10/—	—/1	10/—	—/1	10/—

Technical data

Electrical life	cycles	10 · 10 ⁶		10 · 10 ⁶		10 · 10 ⁶	
Operate/release time	ms	10/10	40/80	10/10	40/80	10/10	40/80
Insulation between input and output (1.2/50 μs)	kV	5.6		5.6		5.6	
Ambient temperature	°C	-30...+80**		-30...+80**		-30...+80**	
Protection category		IP 20		IP 20		IP 20	

Approvals (according to type)



Ordering information

Example: 77 series modular SSR, 1 output 30 A AC, input voltage 230 V AC, relay style terminals arrangement, zero-crossing switch-on.

7 7 . 3 1 . 8 . 2 3 0 . 8 0 5 0

A B C D

<p>Series</p> <p>Type/rated current 0 = 5/7/15 A output (77.01) 1 = 15 A output (77.11) 2 = 25 A output (77.25) 3 = 30 A output (77.31) 4 = 40 A output (77.45) 5 = 50 A output (77.55)</p> <p>No. of poles/mounting 1 = 1 pole, modular housing (plastic or heat sink/plastic), DIN rail mounting 5 = 1 pole, heat-sink or directly panel mounting ("hockey puck")</p> <p>Input version 0 = DC/AC (50/60 Hz) 8 = AC (50/60 Hz) 9 = DC</p> <p>Supply voltage See "input specification"</p>	<p>D: Switch-on mode 0 = Zero-crossing 1 = Random</p> <p>C: Terminals arrangement 5 = "Relay style" (input and output on opposite sides) 7 = "Contactor style" (input and output on adjacent sides)</p> <p>AB: Output circuit (rated voltage) 80 = 230 V AC (77.01), 400 V AC (77.31) 82 = 230 V AC (77.11, 77.x5) 86 = 600 V AC (77.x5) 9024 = 24 V DC 9125 = 110...125 V DC</p>
---	--

<p>Codes/Module width</p> <p>77.01.8.230.8050/17.5 mm 5 A 77.01.0.024.8050/17.5 mm 5 A 77.01.8.230.8051/17.5 mm 5 A 77.01.0.024.8051/17.5 mm 5 A 77.01.9.024.9125/17.5 mm 7 A 77.01.9.024.9024/17.5 mm 15 A</p>	<p>77.11.8.230.8250/22.5 mm 15 A 77.11.9.024.8250/22.5 mm 15 A 77.11.8.230.8251/22.5 mm 15 A 77.11.9.024.8251/22.5 mm 15 A</p>	<p>77.31.8.230.8050/22.5 mm 30 A 77.31.9.024.8050/22.5 mm 30 A 77.31.8.230.8051/22.5 mm 30 A 77.31.9.024.8051/22.5 mm 30 A 77.31.8.230.8070/22.5 mm 30 A 77.31.9.024.8070/22.5 mm 30 A 77.31.8.230.8071/22.5 mm 30 A 77.31.9.024.8071/22.5 mm 30 A</p>	<p>77.25.8.230.8250/hockey puck 25 A 77.25.9.024.8250/hockey puck 25 A 77.25.8.230.8650/hockey puck 25 A 77.25.9.024.8650/hockey puck 25 A 77.45.8.230.8250/hockey puck 40 A 77.45.9.024.8250/hockey puck 40 A 77.45.8.230.8650/hockey puck 40 A 77.45.9.024.8650/hockey puck 40 A 77.55.8.230.8250/hockey puck 50 A 77.55.9.024.8250/hockey puck 50 A 77.55.8.230.8650/hockey puck 50 A 77.55.9.024.8650/hockey puck 50 A</p>
---	---	---	---

Technical data

		77.01.8xxx		77.01.9xxx		77.11		77.31		72.25/45/55			
		Dielectric strength	Impulse (1.2/50 µs)	Dielectric strength	Impulse (1.2/50 µs)	Dielectric strength	Impulse (1.2/50 µs)	Dielectric strength	Impulse (1.2/50 µs)	Dielectric strength	Impulse (1.2/50 µs)		
Between input and output		2500 V AC	5 kV	3000 V AC	4 kV	3000 V AC	6 kV	3000 V AC	6 kV	4000 V AC	5.6 kV		
Between input and ground (heat-sink)		—	—	—	—	3000 V AC	6 kV	3000 V AC	6 kV	4000 V AC	5.6 kV		
Between output and ground (heat-sink)		—	—	—	—	2500 V AC	4 kV	4000 V AC	6 kV	4000 V AC	5.6 kV		
EMC specifications		Reference standard		77.01.8xxx		77.01.9xxx		77.11		77.31		72.25/45/55	
				24 V AC/DC	230 V AC	24 V DC	24 V AC/DC	230 V AC	24 V AC/DC	230 V AC	24 V AC/DC	230 V AC	24 V AC/DC - 230 V AC
Electrostatic discharge	contact discharge	EN 61000-4-2		4 kV		4 kV		4 kV		4 kV		4 kV	
	air discharge	EN 61000-4-2		8 kV		8 kV		8 kV		8 kV		8 kV	
Radiated electromagnetic field (80...1000 MHz)		EN 61000-4-3		30 V/m		—		20 V/m		30 V/m		—	
Fast transients on supply terminals (burst 5/50 ns, 5 and 100 kHz)		EN 61000-4-4		1 kV	4 kV	2 kV	1 kV	3 kV	1 kV	3 kV	2 kV	2 kV	
Voltage pulses on supply terminals (surge 1.2/50 µs)	common mode	EN 61000-4-5		2 kV	4 kV	1 kV	3 kV	3 kV	3 kV	3 kV	3 kV	2 kV	
	differential mode	EN 61000-4-5		1 kV	4 kV	0.5 kV	0.5 kV	1.5 kV	0.5 kV	1.5 kV	1 kV	1 kV	
Radio-frequency common mode voltage (0.15...230 MHz) on supply terminals		EN 61000-4-6		—		10 V		10 V		10 V		—	
Terminals		77.01.8xxx		77.01.9xxx		77.11		77.31		72.25/45/55			
										Input	Output		
Screw torque		Nm		0.8		0.8		0.8		0.8		0.5	1.2
Max. wire size													
		mm ²		solid cable 1 x 6/ 2 x 4		stranded cable 1 x 4/ 2 x 25		solid cable 1 x 6/ 2 x 4		stranded cable 1 x 6/ 2 x 4		solid and stranded cable 1 (with ferrule) 4 (with ferrule) 10 (with fork tip)	
		AWG		1x10/ 2x12		1x12/ 2x14		1x10/ 2x12		1x10/ 2x12		18 (with ferrule) 12 (with ferrule) 8 (with fork tip)	
Wire strip length		mm		9		9		9		9		10	10
Other data													
Power lost to the environment without output current		W		0.5		0.5		0.9		0.9		0.6	
with rated current		W		4.0		4.0		14		16		40/64/80	

Input specification

77.01

Nominal voltage	Input code	Operating range				Must drop-out voltage (AC/DC)	Input current I_N at U_N
		AC		DC			
		U_{min}	U_{max}	U_{min}	U_{max}		
U_N		V	V	V	V	V	mA
24	0.024	16	32	9.8	32	2.4	25
24	9.024	—	—	4	32	3.0	18
230	8.230	90	265	—	—	24	15

77.11

Nominal voltage	Input code	Operating range				Must drop-out voltage (AC/DC)	Input current I_N at U_N
		AC		DC			
		U_{min}	U_{max}	U_{min}	U_{max}		
U_N		V	V	V	V	V	mA
24	9.024	—	—	4	32	2	11
230	8.230	40	305	—	—	6	25

77.31

Nominal voltage	Input code	Operating range				Must drop-out voltage (AC/DC)	Input current I_N at U_N
		AC		DC			
		U_{min}	U_{max}	U_{min}	U_{max}		
U_N		V	V	V	V	V	mA
24	9.024	—	—	4	32	2	11
230	8.230	40	280	—	—	6	25

77.x5.x.xxx.8250

Nominal voltage	Input code	Operating range				Must drop-out voltage (AC/DC)	Input current I_N at U_N
		AC		DC			
		U_{min}	U_{max}	U_{min}	U_{max}		
U_N		V	V	V	V	V	mA
24	9.024	—	—	3	32	1	22
230	8.230	90	280	—	—	10	20

77.x5.x.xxx.8650

Nominal voltage	Input code	Operating range				Must drop-out voltage (AC/DC)	Input current I_N at U_N
		AC		DC			
		U_{min}	U_{max}	U_{min}	U_{max}		
U_N		V	V	V	V	V	mA
24	9.024	—	—	4	32	1	25
230	8.230	90	280	—	—	10	10

Led indication

LED	Supply voltage
	OFF
	ON

LED (77.01.9.024.9xxx only)	Short circuit*
	NO
	YES

* To restore normal operation it is necessary to disconnect the power, resolve the short circuit and then restore power.

D

Output specification

L77-1 Output RMS current v ambient temperature
77.01.0.024.805x @ 32 V DC

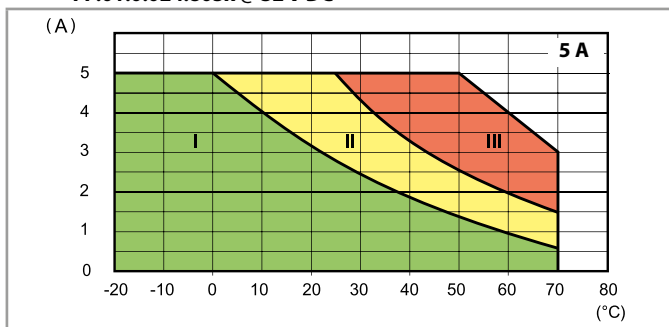

L77-2 Output RMS current v ambient temperature
77.01.8.230.805x @ 265 V AC

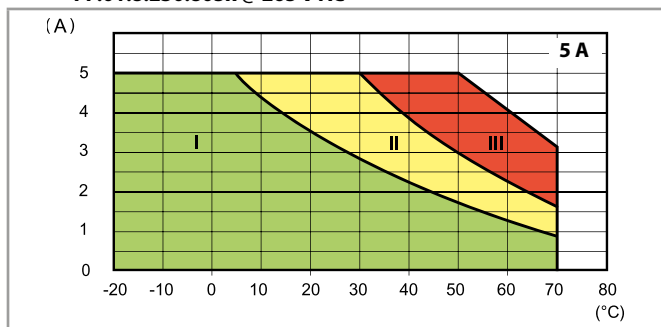

- I - Modular SSR installed as a group (without gap)
- II - Modular SSR installed as a group (9 mm gap between each SSR)
- III - Modular SSR installed individually in free air (without a significant influence from nearby components)

L77-12 Output DC current v ambient temperature
77.01.9.024.9024 @ 32 V DC

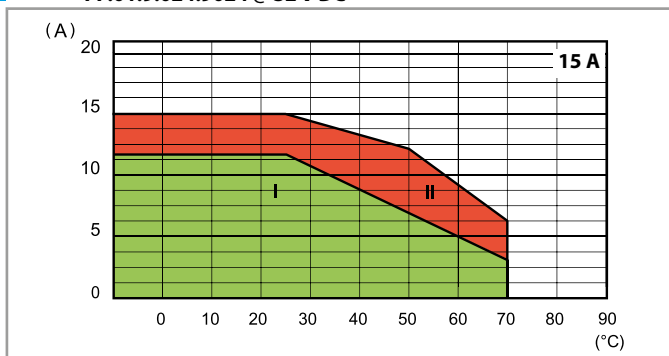

L77-13 Output DC current v ambient temperature
77.01.9.024.9125 @ 32 V DC

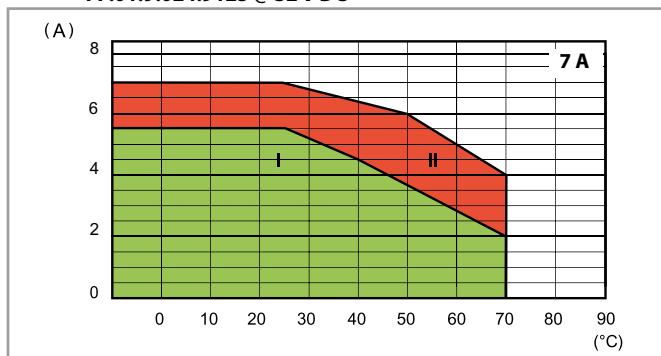

- I - Modular SSR installed as a group (without gap)
- II - Modular SSR installed individually in free air, or with a gap ≥ 9 mm, which implies a not significant influence from nearby components

L77-6 Output RMS current v ambient temperature
77.11.x.xxx.82xx

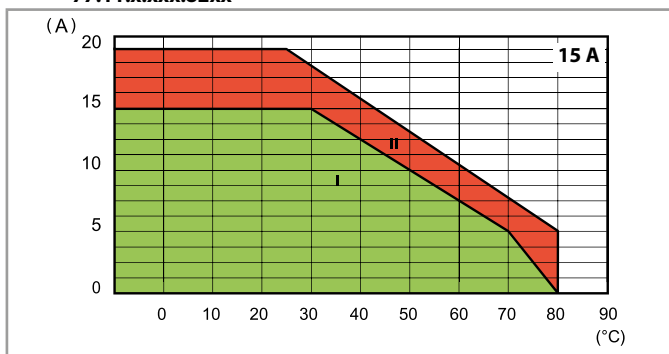

L77-4 Output RMS current v ambient temperature
77.31.x.xxx.80xx

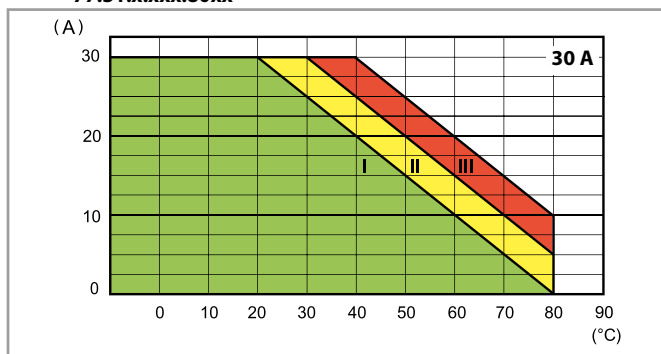

- I - Modular SSR installed as a group (without gap)
- II - Modular SSR installed as a group (20 mm gap between each SSR)
- III - Modular SSR installed individually in free air, or with a gap ≥ 40 mm, which implies a not significant influence from nearby components)

Output specification

L77-10 Output RMS current v ambient temperature
77.25.x.xxx.8x50

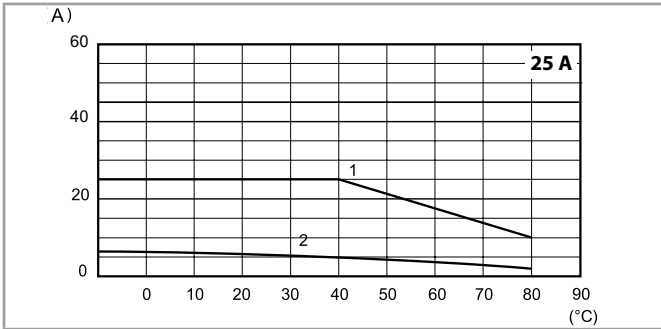

- 1 - Installation on 077.25 heat-sink (2 K/W)
- 2 - Installation individually in free-air

L77-9 Output RMS current v ambient temperature
77.45.x.xxx.8x50

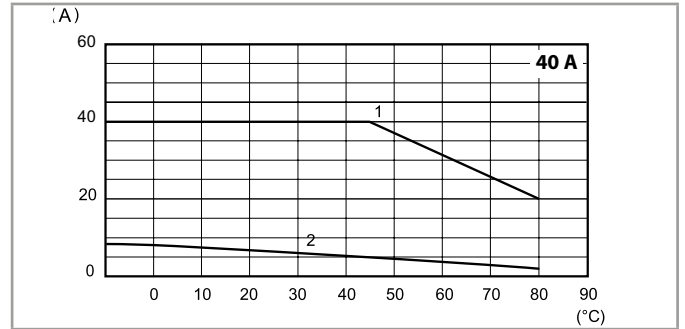

- 1 - Installation on 077.55 heat-sink (0.9 K/W)
- 2 - Installation individually in free-air

L77-8 Output RMS current v ambient temperature
77.55.x.xxx.8x50

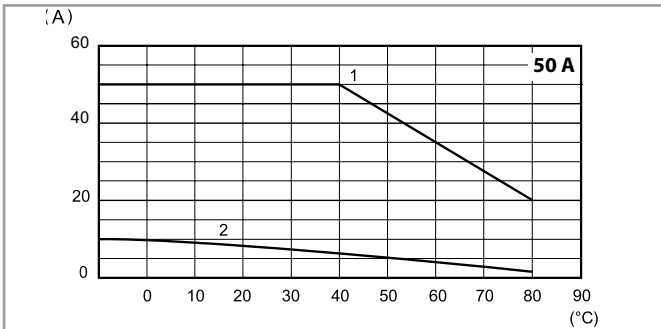

- 1 - Installation on 077.55 heat-sink (0.9 K/W)
- 2 - Installation individually in free-air

L77-3 Inrush peak current (AC) v inrush time
77.01.x.xxx.80xx

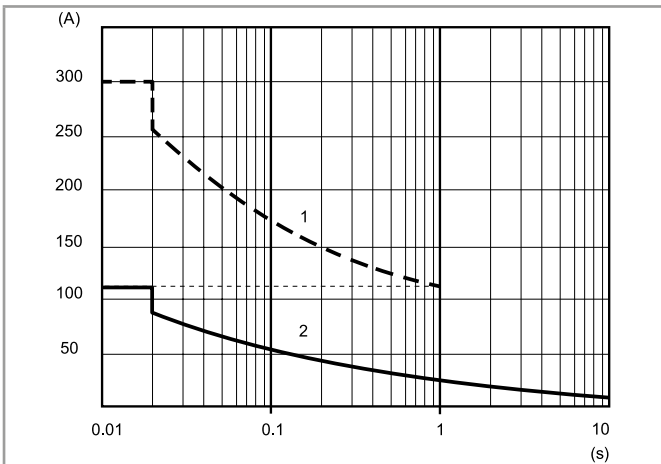

L77-7 Inrush peak current (AC) v inrush time
77.11.x.xxx.82xx

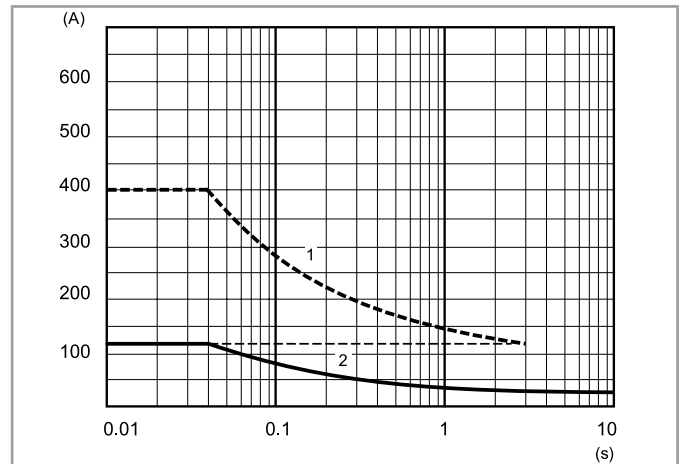

L77-5 Inrush peak current (AC) v inrush time
77.31.x.xxx.80xx

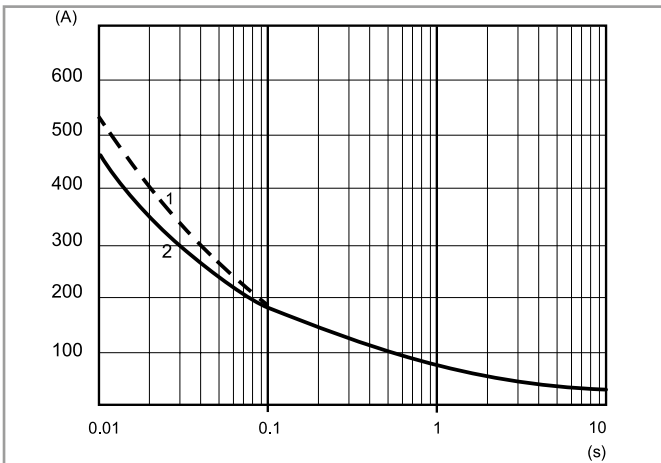

L77-11 Inrush peak current (AC) v inrush time
77x5.x.xxx.8x50

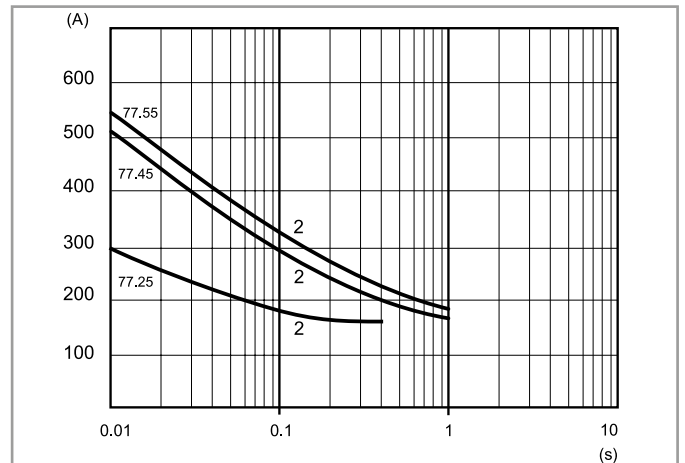

- 1 - "Cold" conditions (ambient temperature = 23 °C, no output current during the last 15 minutes)
- 2 - "Hot" conditions (ambient temperature = 50 °C, rated output current)



Output specification

Max recommended switching frequency (Cycles/Hour, with 50% Duty-cycle)							
Load	77.01.8xxx	77.01.9xxx	77.11	77.31	77.25	77.45	77.55
5 A 230 V (AC1)	5000	—	—	—	—	—	—
5 A 24 V DC L/R = 20 ms	—	3600	—	—	—	—	—
1 A (AC15)	10000	—	—	—	—	—	—
0.5 A (AC15)	20000	—	—	—	—	—	—
15 A 305 V $\cos \varphi = 0.8$	—	—	1800	—	—	—	—
15 A 305 V $\cos \varphi = 0.5$	—	—	1200	—	—	—	—
30 A 480 V $\cos \varphi = 0.8$	—	—	—	1800	—	—	—
30 A 480 V $\cos \varphi = 0.5$	—	—	—	1200	—	—	—
25 A 230 V $\cos \varphi = 0.7$	—	—	—	—	1800	—	—
40 A 230 V $\cos \varphi = 0.7$	—	—	—	—	—	1800	—
50 A 230 V $\cos \varphi = 0.7$	—	—	—	—	—	—	1800

Other data

	77.01.8xxx	77.01.9xxx	77.11	77.31	77.25	77.45	77.55
Critical rising voltage dv/dt without input control (gate open) @ $T_j = 125^\circ\text{C}$	> 1000 V/ μs	> 1000 V/ μs	> 500 V/ μs > 10 V/ μs (with di/dt = 20 A/ms)	> 1000 V/ μs	300 V/ μs (.8250) 500 V/ μs (.8650)	500 V/ μs (.8250) 1000 V/ μs (.8650)	1000 V/ μs (.8250) 1000 V/ μs (.8650)
Critical rising current di/dt @ $T_j = 125^\circ\text{C}$	> 50 A/ μs	> 50 A/ μs	> 50 A/ μs	> 150 A/ μs	—	—	—
I²t for fusing @ $t_p = 10\text{ ms}$	450 A ² s	450 A ² s	1000 A ² s*	1350 A ² s**	450 A ² s	1250 A ² s	1350 A ² s

Suggested fuse (depending on application) for short-circuit protection (Ultra-Fast acting types for semiconductors):

* 20 A, 660 V AC, 10 x 38 mm, 200 kA, 360 A²s.

** 30 A, 660 V AC, 10 x 38 mm, 200 kA, 1000 A²s.

Wiring diagrams

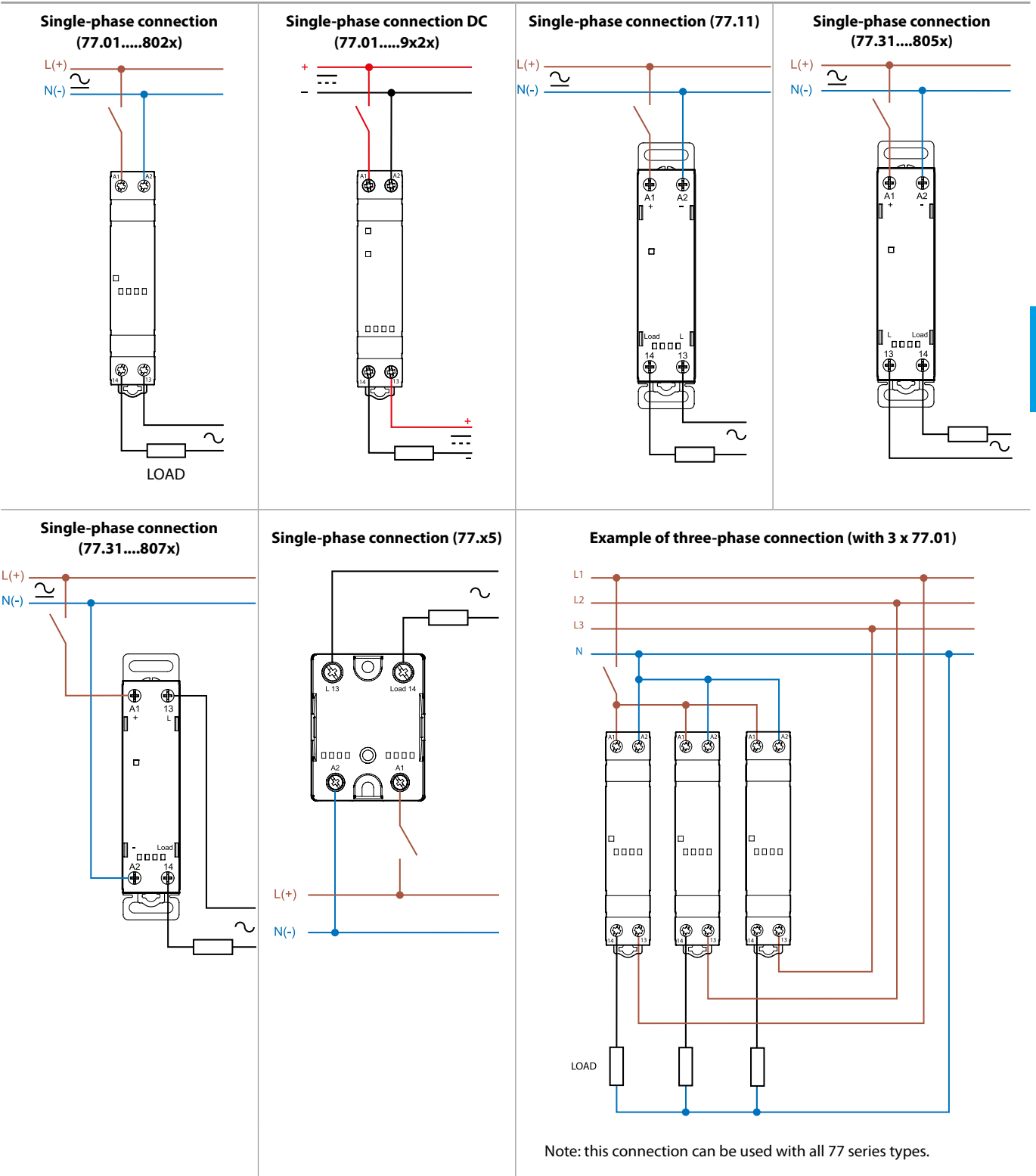

Outline drawings

77.01
Screw terminal

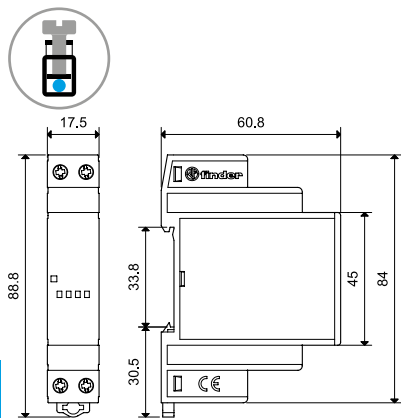

77.11/31
Screw terminal

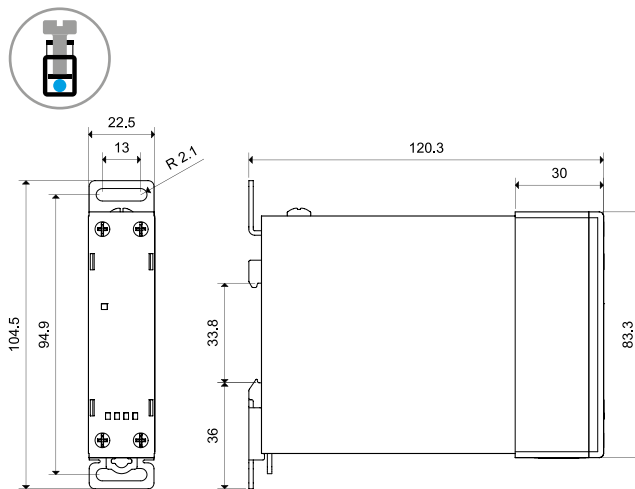

77.01 DC
Screw terminal

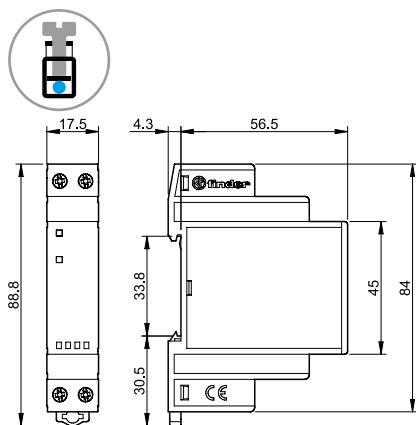

77.x5
Screw terminal (plate clamp)

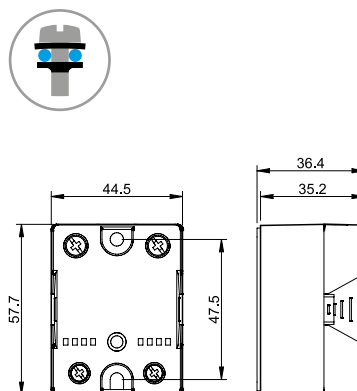

Accessories



Adaptor for panel mounting, plastic, 17.5 mm wide for 77.01 only

020.01

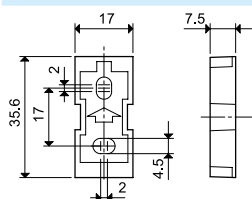

Separator for rail mounting, plastic, 9 mm wide

022.09

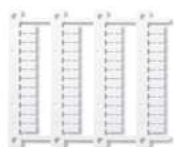
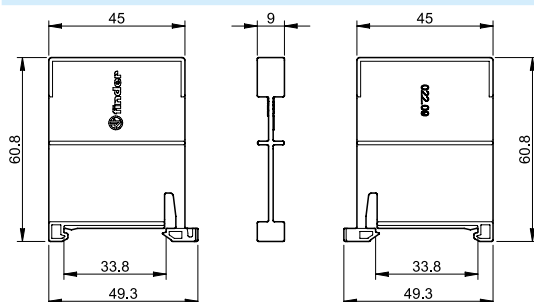

Sheet of marker tags (CEMBRE Thermal transfer printers) for all relays
(48 tags), 6 x 12 mm

060.48

060.48

Accessories



077.25

Heat-sink, anodized aluminium, 2 K/W, 65 x 100 mm, for 77.25 only

077.25

- Both the SSR and 35 mm rail clip mount to the heat-sink using M4 screws (supplied with heat-sink)
- Before assembling to the heat-sink, it is necessary to apply a thin and even layer of thermal conductive paste (not supplied) to the lower metal surface of the SSR

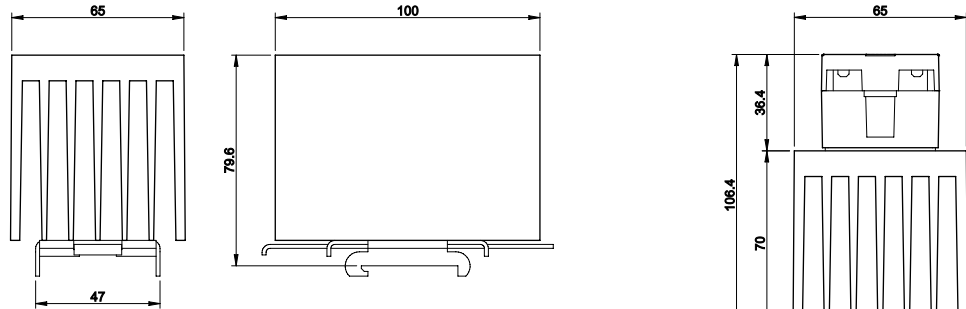

077.25 with 77.25



077.55

Heat-sink, anodized aluminium, 0,9 K/W, 111 x 100 mm, for 77.45 and 77.55

077.55

- Both the SSR and 35 mm rail clip mount to the heat-sink using M4 screws (supplied with heat-sink)
- Before assembling to the heat-sink, it is necessary to apply a thin and even layer of thermal conductive paste (not supplied) to the lower metal surface of the SSR

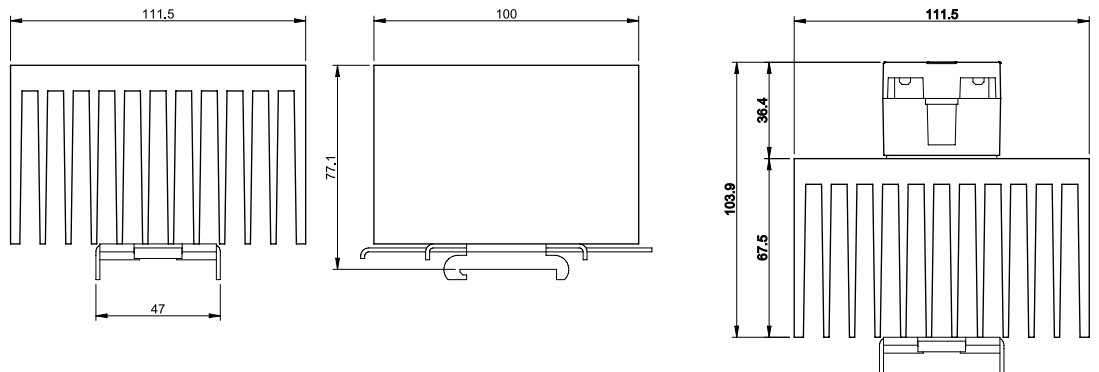

077.55 with 77.45/55





finder[®]
SWITCH TO THE FUTURE

Line monitoring relay

70
SERIES



Air
conditioners



Wood-
processing
machines



Hoists and
cranes



Escalators



Control panels
for pumps



Forced-air
ventilators



Electronic voltage monitoring relays for single and three-phase applications

- Multifunctional types, providing the flexibility of monitoring Undervoltage, Overvoltage, Window Mode, Phase rotation, Phase loss
- Positive safety logic - Make output contact opens if the relay detects an error
- All functions and values can be easily adjusted by the selector and trimmer on front face
- "Blade + cross" – both flat blade and cross head screw drivers can be used to adjust the regulators and the function selector
- Colored LEDs for clear & immediate visual indication
- 1 CO relay output, 6 or 10 A
- Modular housing, 17.5 or 35 mm wide
- 35 mm rail (EN 60715) mount
- Cd-free contact material

Screw terminal



For outline drawing see page 12

Contact specification

Contact configuration		1 CO (SPDT)	1 CO (SPDT)
Rated current/Maximum peak current	A	10/30	6/10
Rated voltage/Max. switching voltage	V AC	250/400	250/400
Rated load AC1	VA	2500	1500
Rated load AC15	VA	750	500
Single phase motor rating (230 V AC)	kW	0.5	0.185
Breaking capacity DC1: 30/110/220 V	A	10/0.3/0.12	6/0.2/0.12
Minimum switching load	mW (V/mA)	300 (5/5)	500 (12/10)
Standard contact material		AgNi	AgNi

Supply specification

Nominal system voltage (U _N)	V AC (50/60 Hz)	220...240	380...415
Rated power	VA (50 Hz)/W	2.6/0.8	11/0.9
Operating range	V AC (50/60 Hz)	130...280	220...510

Technical data

Electrical life at rated load AC1	cycles	80 · 10 ³	60 · 10 ³
Voltage detection level range	V	170...270	300...480
Asymmetry detection level range	%	—	—
Switch-off delay time (T on function diagrams)	s	0.5...60	0.5...60
Switch-on lock-out time	s	0.5	1
Switch-on hysteresis (H on function diagrams)	V	5 (L-N)	10 (L-L)
Power-on activation time	s	≈ 1	≈ 1
Insulation between supply and contacts (1.2/50 μs)	kV	4	4
Dielectric strength between open contacts	V AC	1000	1000
Ambient temperature	°C	-20...+60	-20...+60
Protection category		IP 20	IP 20

Approvals (according to type)



70.11



Single-phase (220...240)V voltage monitoring:

- Undervoltage
- Overvoltage
- Window mode (overvoltage + undervoltage)
- Voltage fault memory selectable

70.31



Three-phase (380...415)V voltage monitoring:

- Undervoltage
- Overvoltage
- Window mode (overvoltage + undervoltage)
- Voltage fault memory selectable
- Phase loss, even under phase regeneration
- Phase rotation

Electronic voltage monitoring relays for three-phase applications

- Multifunctional types, providing the flexibility of monitoring Undervoltage, Overvoltage, Window Mode, Phase rotation, Phase loss, Asymmetry and Neutral loss
- Phase loss monitoring, even under phase regeneration
- Positive safety logic - Make output contact opens if the relay detects an error
- All functions and values can be easily adjusted by the selector and trimmer on front face
- "Blade + cross" – both flat blade and cross head screw drivers can be used to adjust the regulators and the function selector
- Colored LEDs for clear & immediate visual indication
- 1 or 2 CO relay output, 6 or 8 A
- Modular housing, 35 mm wide
- 35 mm rail (EN 60715) mount
- Cd-free contact material

Screw terminal



For outline drawing see page 12

Contact specification

		70.41	70.42
Contact configuration		1 CO (SPDT)	2 CO (DPDT)
Rated current/Maximum peak current	A	6/10	8/15
Rated voltage/ Max. switching voltage	V AC	250/400	250/400
Rated load AC1	VA	1500	2000
Rated load AC15	VA	500	400
Single phase motor rating (230 V AC)	kW	0.185	0.3
Breaking capacity DC1: 30/110/220 V	A	6/0.2/0.12	8/0.3/0.12
Minimum switching load	mW (V/mA)	500 (12/10)	300 (5/5)
Standard contact material		AgNi	AgNi

Supply specification

		70.41	70.42
Nominal system voltage (U_N)	V AC (50/60 Hz)	380...415	380...415
Rated power	VA (50 Hz)/W	11/0.9	12.5/1
Operating range	V AC (50/60 Hz)	220...510	220...510

Technical data

		70.41	70.42
Electrical life at rated load AC1	cycles	$60 \cdot 10^3$	$60 \cdot 10^3$
Voltage detection level range	V	300...480	300...480
Asymmetry detection level range	%	4...25	5...25
Switch-off delay time (T on function diagrams)	s	0.5...60	0.5...60
Switch-on lock-out time	s	1	1
Switch-on hysteresis (H on function diagrams)	V	10 (L-L)	10 (L-L)
Power-on activation time	s	≈ 1	≈ 1
Insulation between supply and contacts (1.2/50 μ s)	kV	4	4
Dielectric strength between open contacts	V AC	1000	1000
Ambient temperature	$^{\circ}$ C	-20...+60	-20...+60
Protection category		IP 20	IP 20

Approvals (according to type)

70.41

Three-phase (380...415 V, with or without neutral) voltage monitoring:

- Window mode (overvoltage + undervoltage)
- Phase loss
- Phase rotation
- Asymmetry
- Neutral loss selectable

70.42

Three-phase (380...415 V, with neutral) voltage monitoring:

- Undervoltage
- Overvoltage
- Window mode (overvoltage + undervoltage)
- Voltage fault memory selectable
- Phase loss
- Phase rotation
- Asymmetry
- Neutral loss

Electronic phase loss and rotation monitoring relays for three-phase applications

- Universal voltage monitoring (U_N from 208 V to 480 V, 50/60 Hz)
- Phase loss monitoring, even under phase regeneration
- Positive safety logic - Make contact opens if the relay detects an error
- 2 versions:
1 CO relay output, 6 A (17.5 mm wide), and
2 CO relay output, 8 A (22.5 mm wide)
- 35 mm rail (EN 60715) mount
- European patent pending for the innovative principle at the root of the 3 phase monitoring and error survey system (70.61)

Screw terminal



For outline drawing see page 12

Contact specification

Contact configuration		1 CO (SPDT)	2 CO (DPDT)
Rated current/Maximum peak current	A	6/15	8/15
Rated voltage/ Max. switching voltage	V AC	250/400	250/400
Rated load AC1	VA	1500	2000
Rated load AC15	VA	250	400
Single phase motor rating (230 V AC)	kW	0.185	0.3
Breaking capacity DC1: 30/110/220 V	A	3/0.35/0.2	8/0.3/0.12
Minimum switching load	mW (V/mA)	500 (10/5)	300 (5/5)
Standard contact material		AgSnO ₂	AgNi

Supply specification

Nominal system voltage (U_N)	V AC (50/60 Hz)	208...480	208...480
Rated power	VA (50 Hz)/W	8/1	11/0.8
Operating range	V AC (50/60 Hz)	170...500	170...520

Technical data

Electrical life at rated load AC1	cycles	100 · 10 ³	60 · 10 ³
Switch-off delay time	s	0.5	0.5
Switch-on lock-out time	s	0.5	0.5
Power-on activation time	s	< 2	< 2
Insulation between supply and contacts (1.2/50 μs)	kV	5	5
Dielectric strength between open contacts	V AC	1000	1000
Ambient temperature	°C	-20...+60	-20...+60
Protection category		IP 20	IP 20

Approvals (according to type)



70.61



Three-phase (208...480)V
voltage monitoring:

- Phase loss
- Phase rotation

70.62



Three-phase (208...480)V
voltage monitoring:

- Phase loss
- Phase rotation

Ordering information

Example: 70 series, three-phase voltage monitoring relay, 1 output, supply voltage 380...415 V AC.

7 0 . 3 1 . 8 . 4 0 0 . 2 . 0 . 2 . 2

A B C D

Series

Type

- 1 = 1 phase AC line monitoring
- 3 = 3 phase AC line monitoring
- 4 = 3 phase + neutral AC line monitoring
- 6 = 3 phase loss and rotation monitoring

No. of poles

- 1 = 1 pole
- 2 = 2 pole

Supply version

- 8 = AC (50/60 Hz)

Supply voltage

- 230 = 220...240 V (70.11)
- 400 = 380...415 V (70.31/41/42)
- 400 = 208...480 V (70.61/62)

D: Fault memory option

- 0 = No fault memory
- 2 = Fault memory function selectable

C: Time delay setting

- 0 = Fixed switch-off delay
- 2 = Adjustable switch-off delay
- 3 = Adjustable switch-off delay and asymmetry

B: Contact circuit

- 0 = CO

A: Detection values

- 0 = Non-adjustable detection values
- 2 = 2 adjustable detection values

Codes

70.11.8.230.2022	70.42.8.400.2032
70.31.8.400.2022	70.61.8.400.0000
70.41.8.400.2030	70.62.8.400.0000

Monitoring and function overview

	70.11	70.31	70.41	70.42	70.61/62
Supply system type	Single phase system	3-phase systems	3-phase systems	3-phase systems	3-phase systems
Nominal voltage 50/60 Hz	V 220...240	380...415	380...415	380...415	208...480
Undervoltage with/without memory (selectable)	•	•	—	•	—
Overvoltage with/without memory (selectable)	•	•	—	•	—
Window Mode with/without memory (selectable)	•	•	—	•	—
Window Mode without memory	—	—	•	—	—
Phase loss	—	•	•	•	•
Phase rotation	—	•	•	•	•
Phase asymmetry	—	—	•	•	—
Neutral loss (selectable)	—	—	•	• (fixed)	—

Technical data

Insulation		70.11/31/41/42		70.61/62	
Between supply and contacts	dielectric strength	V AC	2500	3000	
	impulse (1.2/50 µs)	kV	4	5	
Between open contacts	dielectric strength	V AC	1000	1000	
	impulse (1.2/50 µs)	kV	1.5	1.5	
EMC specifications					
Type of test		Reference standard			
Electrostatic discharge	contact discharge	EN 61000-4-2		4 kV	
	air discharge	EN 61000-4-2		8 kV	
Radiated electromagnetic field	80...1000 MHz	EN 61000-4-3		10 V/m	
	1...2.8 GHz	EN 61000-4-3		5 V/m	
Fast transients (burst 5/50 ns, 5 and 100 kHz)	on supply terminals	EN 61000-4-4		4 kV	
Voltage pulses on supply terminals (surge 1.2/50 µs)	common mode	EN 61000-4-5		4 kV	
	differential mode	EN 61000-4-5		4 kV	
Radiofrequency common mode voltage (0.15...230 MHz)	on supply terminals	EN 61000-4-6		10 V	
Voltage dips	70% U _N	EN 61000-4-11		25 cycles	
Short interruptions		EN 61000-4-11		1 cycle	
Radiofrequency conducted emissions	0.15...30 MHz	CISPR 11		class B	
Radiated emissions	30...1000 MHz	CISPR 11		class B	
Terminals		solid cable		stranded cable	
Max. wire size	mm ²	1 x 6 / 2 x 4		1 x 4 / 2 x 2.5	
	AWG	1 x 10 / 2 x 12		1 x 12 / 2 x 14	
 Screw torque	Nm	0.8			
Wire strip length	mm	9			
Other data		70.11	70.31/41	70.42/61/62	
Power lost to the environment	without output current	W	0.8	0.9	
	with rated output current	W	2	1.2	
				1.4	

Functions

Output relay On (NO closed) when all OK: positive logic.

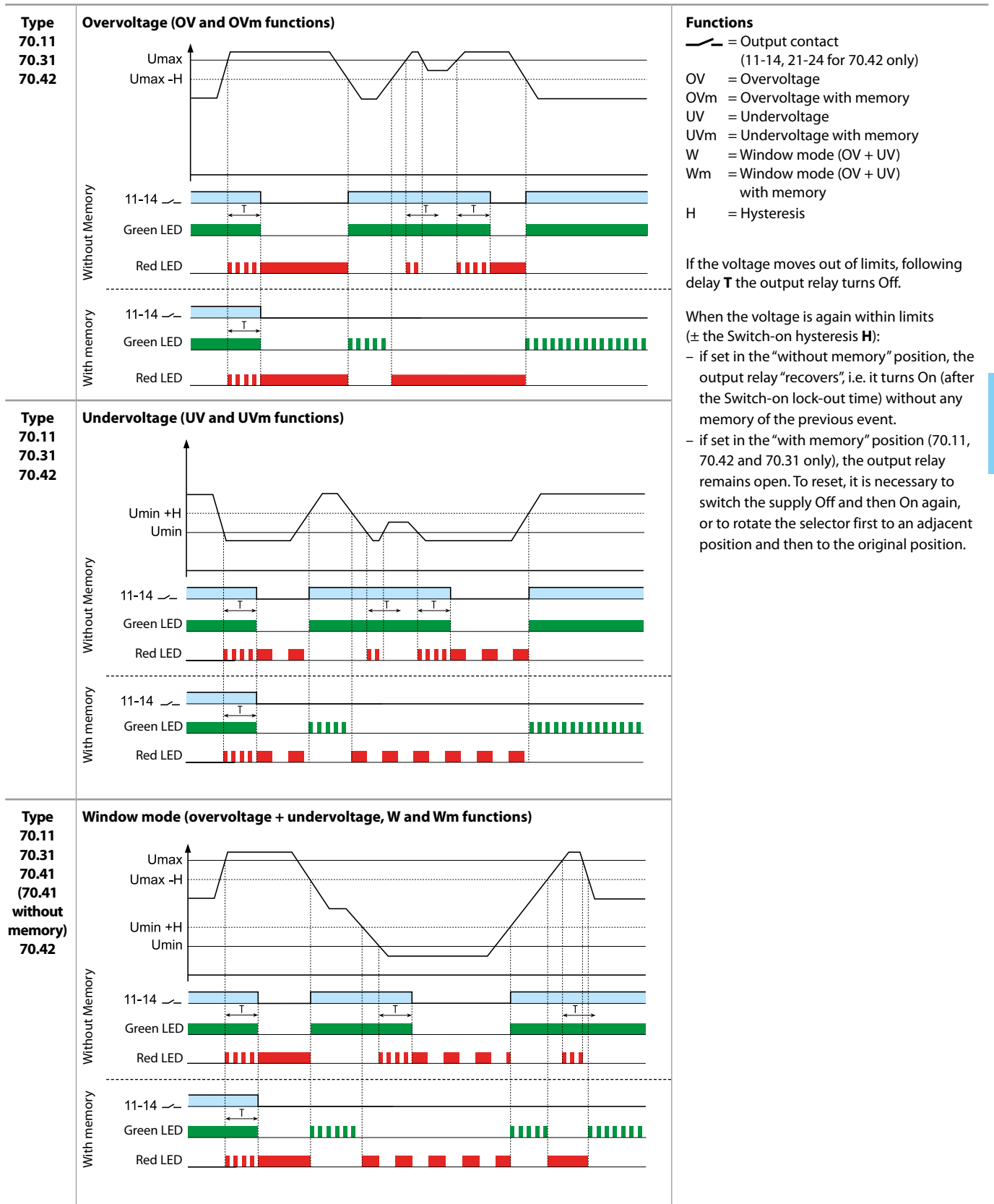

E

Functions

Output relay On (NO closed) when all OK: positive logic.

<p>Type 70.31 70.41 70.42 70.61 70.62</p>	<p>Phase loss and phase rotation</p>	<p>If the sequence (L1, L2, L3) is incorrect at power-on, the output relay will not turn-on.</p> <p>If a phase is lost, the output relay turns off immediately. When the phase is again active, the output relay turns on immediately.</p> <p>Phase loss monitoring possible even under regeneration up to 80% of the average of the other 2 phases.</p>
<p>E Type 70.41 70.42</p>	<p>Neutral loss and asymmetry</p>	<p>If the neutral is lost (and the Neutral control function is set), the output relay turns off immediately. When the neutral is again present, the output relay turns on immediately.</p> <p>If the asymmetry $(U_{max} - U_{min})/U_N$ is above the % set value, the output relay turns off after the set delay T. When the asymmetry is again below the % set value (with a fixed hysteresis of approximately 2%), the output relay turns on after the Switch-on lock-out time.</p>

Front view: function selector and regulators

<p>70.11</p> <p>Functions: OV, OVm, UV, UVm, W, Wm</p> <p>T_{off} delay: (0.5...60)sec</p> <p>U_{Max}: (220...270)V</p> <p>U_{Min}: (170...230)V</p>	<p>70.31</p> <p>Functions: OV, OVm, UV, UVm, W, Wm</p> <p>U_{Max}: (380...480)V</p> <p>U_{Min}: (300...400)V</p> <p>T_{off} delay: (0.5...60) sec</p>	<p>70.41</p> <p>N= With N-line monitoring N≠ Without N-line monitoring</p> <p>U_{Max}: (380...480)V</p> <p>$(4...25)\% U_N$</p> <p>U_{Min}: (300...400)V</p> <p>T_{off} delay: (0.5...60)sec</p>
<p>70.42</p> <p>Functions: OV, OVm, UV, UVm, W, Wm</p> <p>U_{Max}: (380...480)V</p> <p>$(5...25)\% U_N$</p> <p>U_{Min}: (300...400)V</p> <p>T_{off} delay: (0.5...60)sec</p>		

E

LED indication

Monitoring relay Type	LED	Supply system normal	Supply system abnormal (Voltage out of limits, switch-off delay time T running)	Supply system abnormal (Reason for switch-off, RESET necessary when "with Memory"* is selected)
		Contact 11 - 14 closed	Contact 11 - 14 closed	Contact 11-14 open
70.11.8.230.2022	• •		 	Overvoltage OV and OVm Undervoltage UV and UVm With Memory, following a failure a manual "RESET" ** is necessary
70.31.8.400.2022	• • •		 	Overvoltage OV and OVm Undervoltage UV and UVm Phase loss Phase rotation With Memory, following a failure a manual "RESET" ** is necessary
70.41.8.400.2030	• • •		 	Overvoltage OV Undervoltage UV Asymmetry Phase loss Neutral loss Phase rotation
70.42.8.400.2032	• • •		 	Overvoltage OV and OVm Undervoltage UV and UVm Asymmetry Phase loss Neutral loss Phase rotation With Memory, following a failure a manual "RESET" ** is necessary
70.61.8.400.0000	•			Phase rotation or Phase loss
70.62.8.400.0000	•			Phase loss Phase rotation

* The function "with Memory" is only available for type 70.11, 70.42 and 70.31.

** It is necessary to switch the supply OFF and then On again (U off U on) or to rotate the function selector first to an adjacent position and then to the original position.

Wiring diagrams

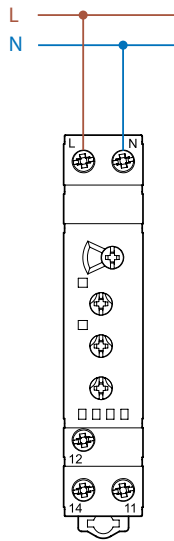

Type 70.11

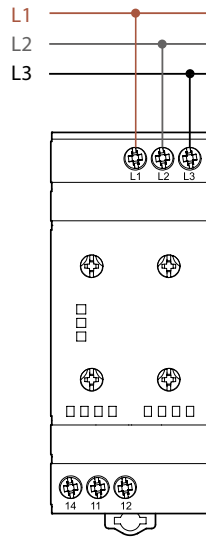

Type 70.31

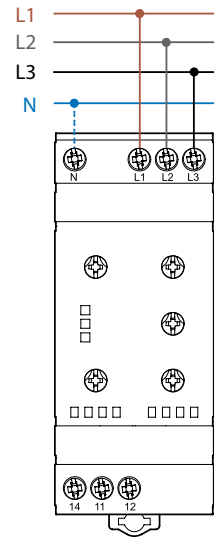

Type 70.41

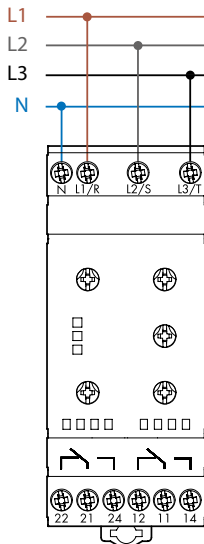

Type 70.42

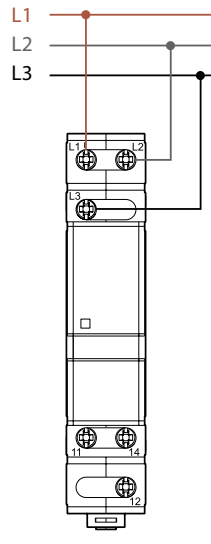

Type 70.61

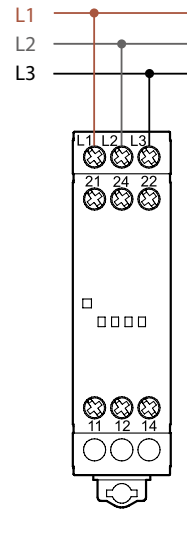

Type 70.62

E

Application example

The output contact switches the coil of the line contactor.

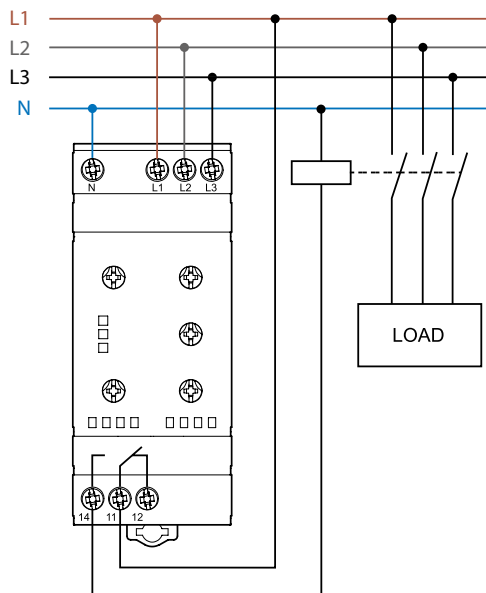

Outline drawings

70.11
Screw terminal

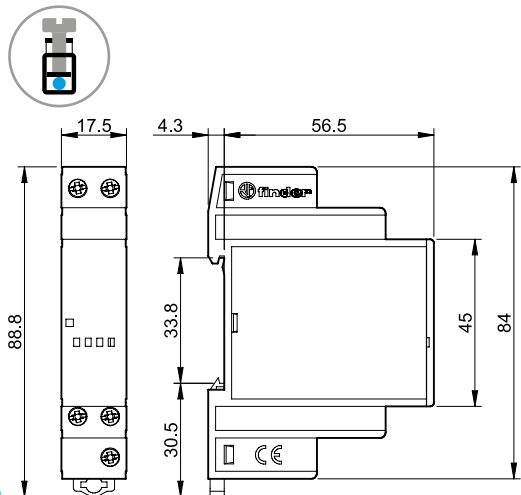

70.31
Screw terminal

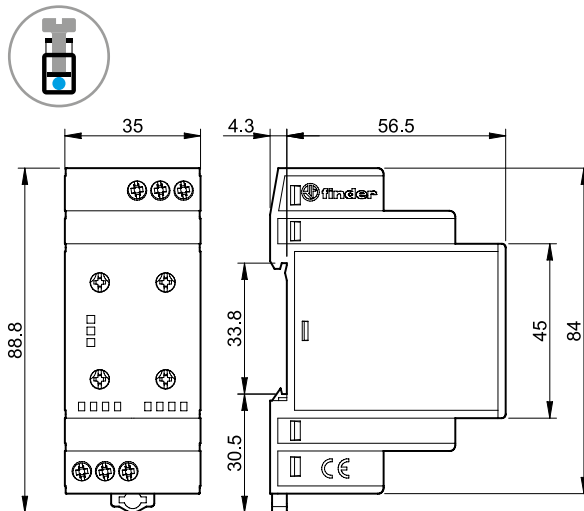

E 70.41
Screw terminal

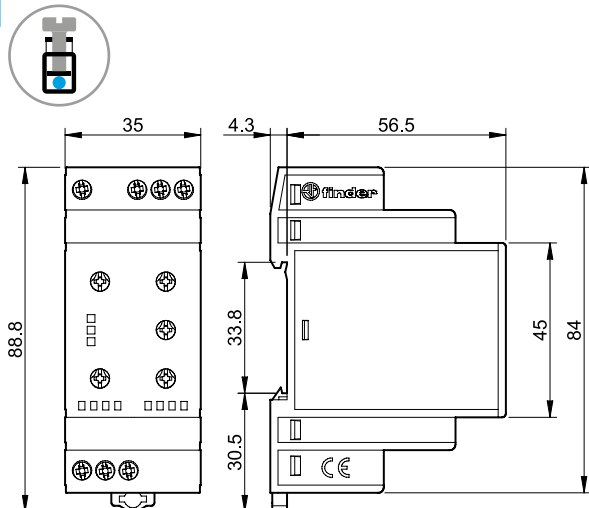

70.42
Screw terminal

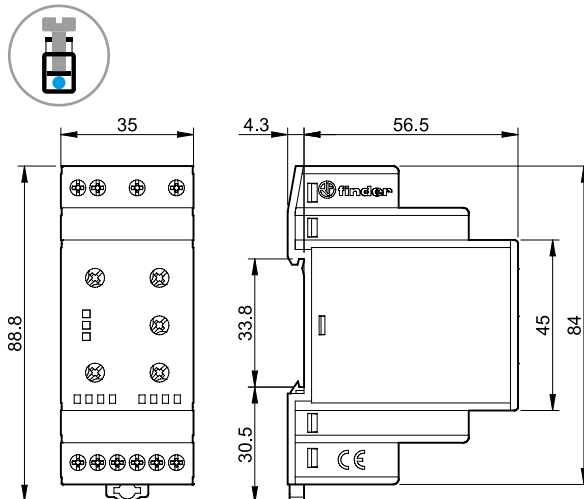

70.61
Screw terminal

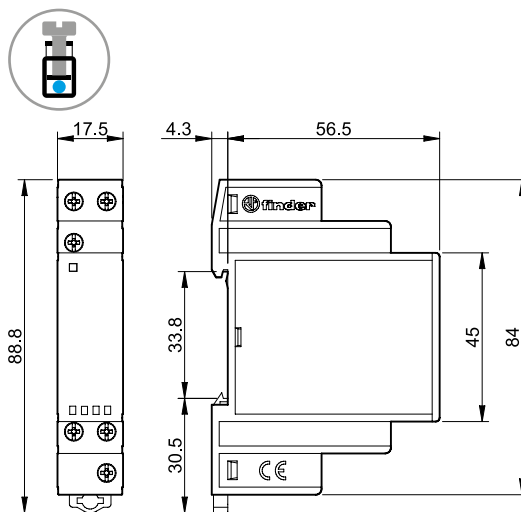

70.62
Screw terminal

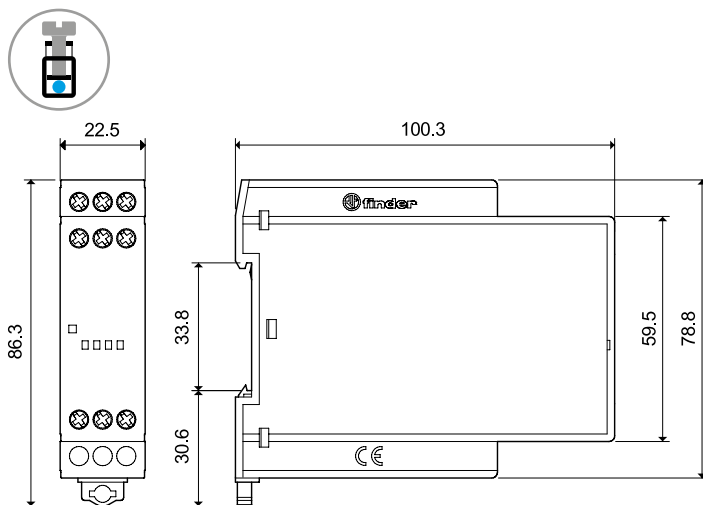

Accessories



020.01

Adaptor for panel mounting, plastic, 17.5 mm wide for 70.11 and 70.61

020.01

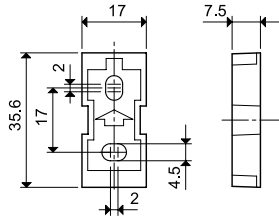

011.01

Adaptor for panel mounting, plastic, 35 mm wide for 70.31, 70.42 and 70.41

011.01

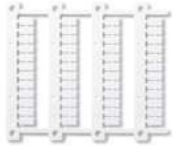
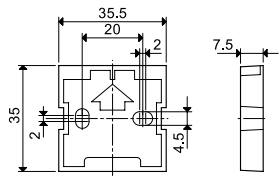

060.48

Sheet of marker tags (CEMBRE Thermal transfer printers) for relays types 70.11, 70.31, 70.41, 70.42 and 70.62 (48 tags), 6 x 12 mm

060.48



020.24

Sheet of marker tags, plastic, 24 tags, 9 x 17 mm for 70.61

020.24



019.01

Identification tag, plastic, 1 tag, 17 x 25.5 mm for 70.11, 70.31, 70.42 and 70.41

019.01



022.09

Separator for rail mounting, plastic, 9 mm wide

022.09

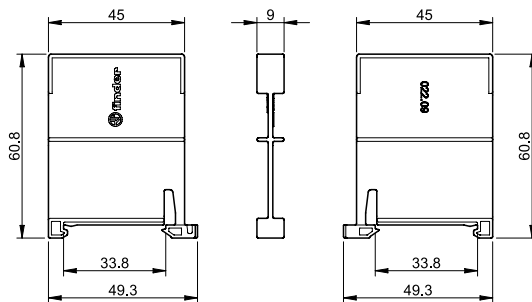



finder[®]
SWITCH TO THE FUTURE

Monitoring relays 10 A

71
SERIES



Industrial motors



Industrial refrigerators



Elevators and lifts



Textile machines



Labelling machines



Carousel warehouses



- 1 - Phase 230 V**
Over & Under voltage monitoring relays
- 71.11.8.230.0010**
- Fixed Over & Under voltage detection
- Link selectable 5 or 10 minute lock-out delay
- 71.11.8.230.1010**
- Adjustable Over & Under voltage detection
- Switch selectable 5 or 10 minute lock-out delay
- 35 mm rail (EN 60715) mounting
 - LED indication
 - Positive safety logic (healthy conditions - output relay energised)

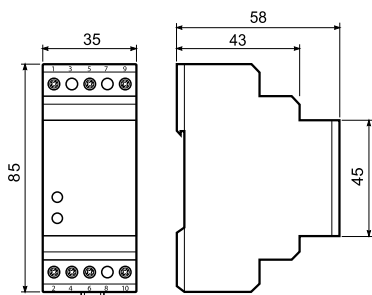

71.11.8.230.0010



- Fixed - Over/Under voltage limits, (0.75...1.2)U_N respectively
- Link selectable - 5 min or 10 min delay

71.11.8.230.1010



- Adjustable - symmetrical Over/Under voltage limits adjustable between ± 5% to ± 20% U_N
- Switch selectable - 5 min or 10 min delay

- Detects and trips on out-of-limits L-N voltage, and protects against excessive "starts/hour" through "power-on" and "lock-out" time delays.
- Typical applications - protection of compressor motors and high pressure discharge lamp circuitry.

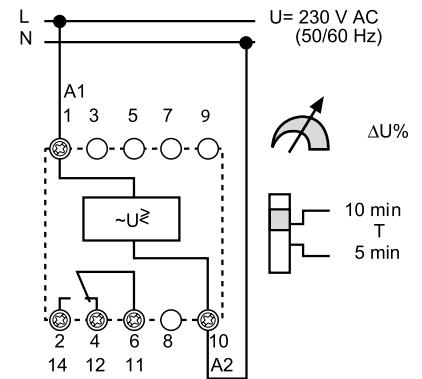
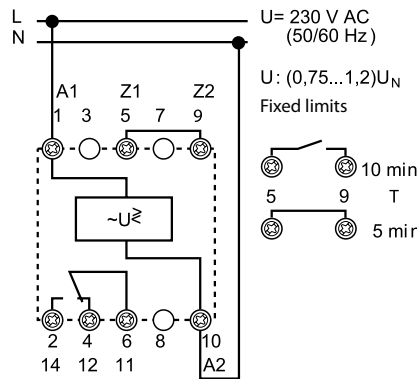

Contact specification

Contact configuration		1 CO (SPDT)	1 CO (SPDT)
Rated current/Maximum peak current	A	10/15	10/15
Rated voltage/Maximum switching voltage	V AC	250/400	250/400
Rated load AC1	VA	2500	2500
Rated load AC15 (230 V AC)	VA	500	500
Single phase motor rating (230 V AC)	kW	0.5	0.5
Breaking capacity DC1: 30/110/220 V	A	10/0.3/0.12	10/0.3/0.12
Minimum switching load	mW (V/mA)	300 (5/5)	300 (5/5)
Standard contact material		AgCdO	AgCdO

Supply specification

Nominal voltage (U _N)	V AC (50/60 Hz)	230	230
	V DC	—	—
Rated power AC/DC	VA (50 Hz)/W	4/—	4/—
Operating range	AC	(0.75...1.2)U _N	(0.8...1.2)U _N
	DC	—	—

Technical data

Electrical life at rated load AC1	cycles	100 · 10 ³	100 · 10 ³
Detection levels		Fixed (0.75...1.2)U _N	Adjustable (± 5...± 20)% U _N
Switch-on lock-out time/reaction time		(5 or 10)min/< 0.5 s	(5 or 10)min/< 0.5 s
Fault memory		—	—
Electrical isolation: Supply to Measuring circuits		None - circuits are electrically common	None - circuits are electrically common
Ambient temperature range	°C	-20...+55	-20...+55
Protection category		IP 20	IP 20

Approvals (according to type)



3 - Phase 400 V**Over & Under voltage monitoring relay****71.31.8.400.1010**

- Adjustable Over & Under voltage detection
- Switch selectable 5 or 10 minute lock-out delay

- 35 mm rail (EN 60715) mounting
- LED indication
- Positive safety logic (healthy conditions - output relay energised)

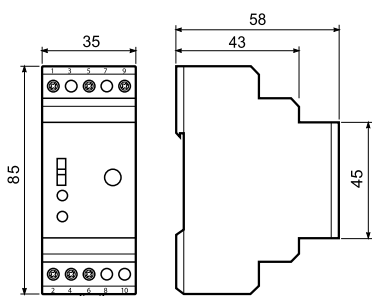
**71.31.8.400.1010**

- Adjustable - symmetrical Over/Under voltage limits adjustable between $\pm 5\%$ to $\pm 20\%$ U_N
- Switch selectable - 5 min or 10 min delay

- Detects and trips on out-of-limits L-L voltage, and protects against excessive "starts/hour" through "power-on" and "lock-out" time delays.
- Typical applications - protection of compressor motors and high pressure discharge lamp circuitry.

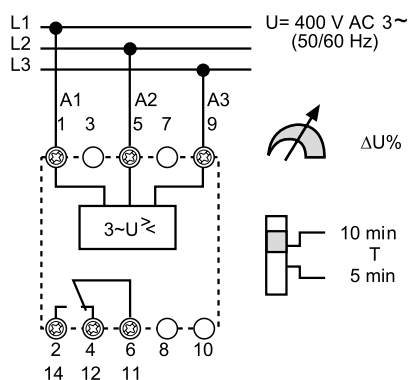
**Contact specification**

Contact configuration		1 CO (SPDT)
Rated current/Maximum peak current	A	10/15
Rated voltage/ Maximum switching voltage	V AC	250/400
Rated load AC1	VA	2500
Rated load AC15 (230 V AC)	VA	500
Single phase motor rating (230 V AC)	kW	0.5
Breaking capacity DC1: 30/110/220 V	A	10/0.3/0.12
Minimum switching load	mW (V/mA)	300 (5/5)
Standard contact material		AgCdO

Supply specification

Nominal voltage (U_N)	V AC (50/60 Hz)	400
	V DC	—
Rated power AC/DC	VA (50 Hz)/W	4/—
Operating range	AC	$(0.8 \dots 1.2)U_N$
	DC	—

Technical data

Electrical life at rated load AC1	cycles	$100 \cdot 10^3$
Detection levels	V (50/60 Hz)	Adjustable $(\pm 5 \dots \pm 20)\% U_N$
Switch-on lock-out time/reaction time		(5 or 10)min / < 0.5 s
Fault memory		—
Electrical isolation: Supply to Measuring circuits		None – circuits are electrically common
Ambient temperature range	$^{\circ}\text{C}$	$-20 \dots +55$
Protection category		IP 20

Approvals (according to type)

3 - Phase 400 V - Line monitoring relays

71.31.8.400.1021

- Over & Under voltage trip on-delay
- Fault memory

71.31.8.400.2000

- Phase asymmetry
- Phase rotation
- Phase loss

- 35 mm rail (EN 60715) mounting
- LED indication
- Positive safety logic (healthy conditions - output relay energised)

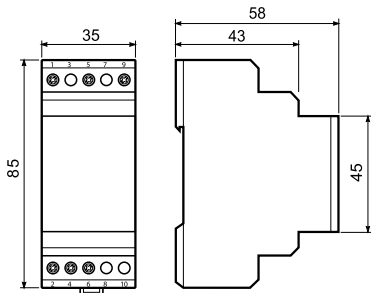

71.31.8.400.1021



- 3 phase 400 V - line voltage monitoring
- Detects over and under voltage
- Adjustable trip on-delay
- Switch selectable fault memory

- Under voltage trip level $(0.8 \dots 0.95)U_N$ - Adjustable
- Over voltage trip level $1.15 U_N$ - Fixed
- Trip delay time $(0.1 \dots 12)s$ adjustable
- Fault memory, switch selectable
- Fault acknowledgement by switch manipulation from ON to OFF and back to ON or power down

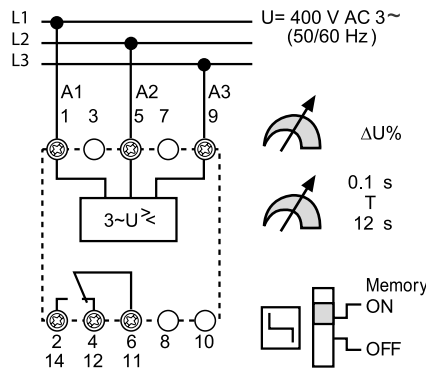

71.31.8.400.2000



- 3 phase asymmetry monitoring
- Phase rotation monitoring
- Phase loss monitoring

- Asymmetry between phases $(-5 \dots -20)\% U_N$ adjustable
- Detection of the supply voltage U to A1 (1) and/or A2 (5) $> 1.11 U_N$

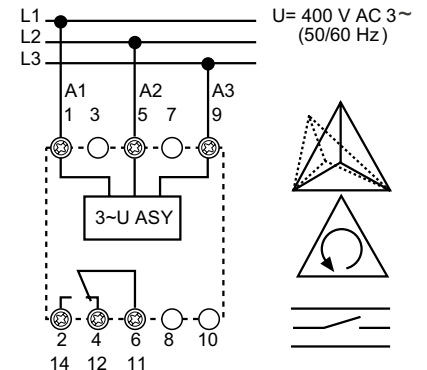

Contact specification

Contact configuration		1 CO (SPDT)	1 CO (SPDT)
Rated current/Maximum peak current	A	10/15	10/15
Rated voltage/ Maximum switching voltage	V AC	250/400	250/400
Rated load AC1	VA	2500	2500
Rated load AC15 (230 V AC)	VA	500	500
Single phase motor rating (230 V AC)	kW	0.5	0.5
Breaking capacity DC1: 30/110/220 V	A	10/0.3/0.12	10/0.3/0.12
Minimum switching load	mW (V/mA)	300 (5/5)	300 (5/5)
Standard contact material		AgCdO	AgCdO

Supply specification

Nominal voltage (U_N)	V AC (50/60 Hz)	400	400
	V DC	—	—
Rated power AC/DC	VA (50 Hz)/W	4/—	4/—
Operating range	AC	$(0.8 \dots 1.15)U_N$	$(0.8 \dots 1.15)U_N$
	DC	—	—

Technical data

Electrical life at rated load AC1	cycles	$100 \cdot 10^3$	$100 \cdot 10^3$
Detection level	$U_{min}/U_{max}/Asymmetry$	$(0.8 \dots 0.95)U_N / 1.15 U_N / —$	$0.8 U_N / 1.11 U_N / (-5 \dots -20)\% U_N$
Trip on-delay/reaction time		$(0.1 \dots 12)s / < 0.5 s$	$— / < 0.5 s$
Fault memory - selectable		Yes	—
Electrical isolation: Supply to Measuring circuits		None – circuits are electrically common	None – circuits are electrically common
Ambient temperature range	°C	$-20 \dots +55$	$-20 \dots +55$
Protection category		IP 20	IP 20

Approvals (according to type)



Universal voltage or current detecting and monitoring relay
71.41.8.230.1021 - Voltage monitoring
71.51.8.230.1021 - Current monitoring

- Zero voltage memory according to EN 60204-7-5
- Programmable for DC or AC detection level:
 - range detecting: upper and lower value
 - upper set point minus hysteresis range (5...50)% for switch on
 - lower set point plus hysteresis range (5...50)% for switch on
- Fault memory
- Electrical isolation between measuring and supply circuits
- Immune to supply interruptions of < 200 ms
- Wide detecting range:
 - voltage: DC (15...700)V, AC (15...480)V
- 35 mm rail (EN 60715) mounting

71.41.8.230.1021

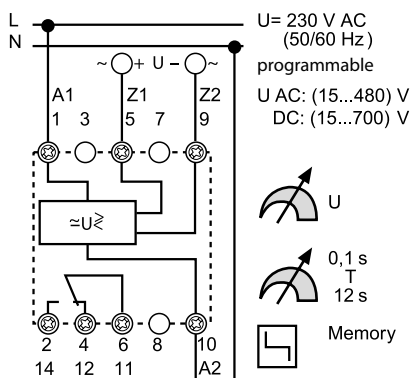

- Programmable universal voltage monitoring relay

- AC/DC voltage detection - adjustable
- AC (50/60 Hz) (15...480)V
- DC (15...700)V
- Switch-on hysteresis (5...50)%
- Switch-off delay (0.1...12)s

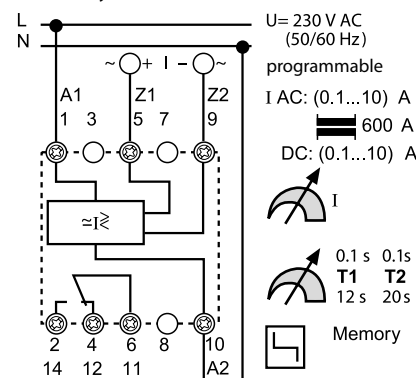

71.51.8.230.1021

- Programmable universal current monitoring relay
- Usable with current transformer 50/5, 100/5, 150/5, 250/5, 300/5, 400/5 or 600/5

- AC/DC current detection - adjustable
- AC (50/60 Hz) (0.1...10)A with current transformer to 600 A
- DC (0.1...10)A
- Switch-on hysteresis (5...50)%
- Switch-off delay (0.1...12)s
- Start delay (0.1...20)s

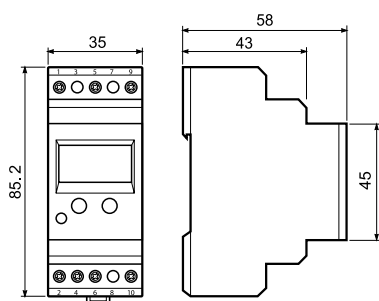

E

Contact specification

Contact configuration		1 CO (SPDT)	1 CO (SPDT)
Rated current/Maximum peak current	A	10/15	10/15
Rated voltage/ Maximum switching voltage	V AC	250/400	250/400
Rated load AC1	VA	2500	2500
Rated load AC15 (230 V AC)	VA	500	500
Single phase motor rating (230 V AC)	kW	0.5	0.5
Breaking capacity DC1: 30/110/220 V	A	10/0.3/0.12	10/0.3/0.12
Minimum switching load	mW (V/mA)	300 (5/5)	300 (5/5)
Standard contact material		AgCdO	AgCdO

Supply specification

Nominal voltage (U_N)	V AC (50/60 Hz)	230	230
	V DC	—	—
Rated power AC/DC	VA (50 Hz)/W	4/—	4/—
Operating range	AC	$(0.85...1.15)U_N$	$(0.85...1.15)U_N$
	DC	—	—

Technical data

Electrical life at rated load AC1	cycles	$100 \cdot 10^3$	$100 \cdot 10^3$
Detection levels	AC(50/60 Hz)/DC	$(15...480)V/(15...700)V$	$(0.1...10)A$ at transducer to 600 A/ $(0.1...10)A$
Switch-off/reaction/Start delay		$(0.1...12)s < 0.35 s / < 0.5 s$	$(0.1...12)s < 0.35 s / (0.1...20)s$
Switch-on level of the detecting level	%	5...50	5...50
Fault memory - programmable		Yes	Yes
Electrical isolation: Supply to Measuring circuits		Yes	Yes
Ambient temperature range	°C	-20...+55	-20...+55
Protection category		IP 20	IP 20

Approvals (according to type)

Thermistor temperature sensing relays for industrial applications

- 71.91 - 1 Pole, without fault memory**
- 71.92 - 2 Pole, with fault memory**

- Overload protection according EN 60204-7-3
- Positive safety logic - make contact opens if the measured value is outside of the acceptable range
- Industry standard module
- LED status indication
- 35 mm rail (EN 60715) mounting

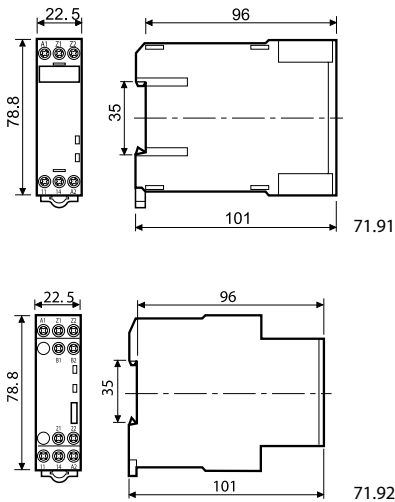

71.91.x.xxx.0300



- Thermistor relay
- 1 Pole normally open contact
- 24 V AC/DC, or 230 V AC supply
- Temperature detection with PTC
- PTC short circuit detection
- PTC wire breakage detection

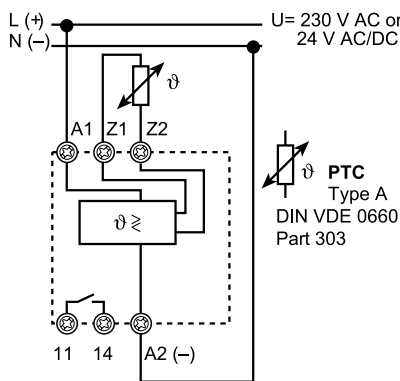

71.92.x.xxx.0001



- Thermistor relay with fault memory
- 2 Pole changeover contacts
- 24 V AC/DC, or 230 V AC supply
- Temperature detection with PTC
- Fault memory - switch selectable
- Reset by Reset button or supply interruption
- PTC short circuit detection
- PTC wire breakage detection

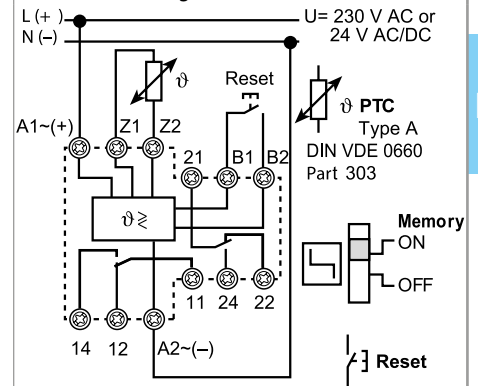

Contact specification

Contact configuration		1 NO (SPST-NO)	2 CO (DPDT)
Rated current/Maximum peak current	A	10/15	10/15
Rated voltage/			
Maximum switching voltage	V AC	250/400	250/400
Rated load AC1	VA	2500	2500
Rated load AC15 (230 V AC)	VA	500	500
Single phase motor rating (230 V AC)	kW	0.5	0.5
Breaking capacity DC1: 30/110/220 V	A	10/0.3/0.12	10/0.3/0.12
Minimum switching load	mW (V/mA)	300 (5/5)	300 (5/5)
Standard contact material		AgCdO	AgCdO
Supply specification			
Nominal voltage (U _N)	V AC (50/60 Hz)	230	230
	V AC/DC	24	24
Rated power AC/DC	VA (50 Hz)/W	1/0.5	1/0.5
Operating range	AC	(0.85...1.15)U _N	(0.85...1.15)U _N
	DC	—	—

Technical data

Electrical life at rated load AC1	cycles	100 · 10 ³	100 · 10 ³
PTC detecting: Short circuit/Temperature OK		< 20 Ω / > 20 Ω... < 3 kΩ	< 20 Ω / > 20 Ω... < 3 kΩ
Reset/PTC break		< 1.3 kΩ / > 3 kΩ	< 1.3 kΩ / > 3 kΩ
Delay time/activation time		— / < 0.5 s	— / < 0.5 s
Fault memory - switch selectable		—	Yes
Electrical isolation: Supply to Measuring circuits		Yes	Yes
Ambient temperature range	°C	-20...+55	-20...+55
Protection category		IP 20	IP 20

Approvals (according to type)



Ordering information

Example: Universal voltage monitoring relay with LCD display for AC/DC voltage detection, 1 CO (SPDT) contact rated 10 A 250 V, supply voltage 230 V, programmable delay time and fault memory.

7 1 . 4 1 . 8 . 2 3 0 . 1 0 2 1

Series

Type

- 1 = 1 phase AC line monitoring
- 3 = 3 phase AC line monitoring
- 4 = AC/DC universal- Voltage detection
- 5 = AC/DC universal- Current detection
- 9 = Thermistor relay (temperature monitoring with PTC thermistor)

No. of poles

- 1 = 1 CO (SPDT) types 71.11, 31, 41, 51
- 1 = 1 NO (SPST-NO) type 71.91
- 2 = 2 CO (DPDT) type 71.92

Supply version

- 0 = AC(50/60 Hz)/DC
- 8 = AC (50/60 Hz)

Supply voltage

- 024 = 24 V AC/DC
- 230 = 230 V
- 400 = 400 V

Additional functions

- 0 = Basic function
- 1 = Adjustable detection value
- 2 = Adjustable: Asymmetry, phase loss, phase rotation

Special versions

- 0 = No fault memory
- 1 = Fault memory

Options

- 0 = No delay time
- 1 = Two selectable delay times
- 2 = Adjustable delay times

Contact circuit

- 0 = CO (nPDT)
- 3 = NO (nPST-NO)

E

Technical data

Insulation				
Insulation according to EN 61810-1	insulation rated voltage	V	250	
	rated impulse withstand voltage	kV	4	
	pollution degree		3	
	over-voltage category		III	
Dielectric strength (A1, A2, A3, B1, B2), and contact terminals (11, 12, 14) and terminals (Z1, Z2)	V AC	2500		
	kV (1.2/50 µs)	6		
Dielectric strength at open contact	V AC	1000		
EMC specifications				
Type of test		Reference Standard		
Electrostatic discharge	contact discharge	EN 610004-2	8 kV	
	air discharge	EN 610004-2	8 kV	
Radio-frequency electromagnetic field (80...1000)MHz		EN 610004-3	3 V/m	
Fast transients (burst) (5-50 ns, 5 kHz) on (A1, A2, A3, B1, B2) and (Z1, Z2)		EN 610004-4	2 kV	
Surges (1.2/50 µs) on (A1, A2, A3, B1, B2) and (Z1, Z2)	common mode	EN 610004-5	4 kV	
	differential mode	EN 610004-5	4 kV	
Radio-frequency common mode (0.15 ÷ 80 MHz) to A1 - A2		EN 610004-6	10 V	
Radiated and conducted emission		EN 55022	class B	
Other data				
Voltage and current values at terminals Z1 Z2	Type 71.11	Link for time range	V / mA 230 V/—	
	Type 71.91, 71.92	PTC temperature measurement	V / mA 24 V/2.4	
Maximum length of wiring to the Supply terminals/ Measuring terminals	Type 71.11, 71.31	Contact bridge for time range	m 150/—	
	Type 71.41	Voltage measurement	m 150/50	
	Type 71.51	Current measurement	m 150/50	
(Wiring capacitance no greater than 10 nF/100 m)	Type 71.91, 71.92	PTC temperature measurement	m 50/50	
Measuring principle	Type 71.11, 71.31, 71.41, 71.51, 71.91, 71.92	The measured value is the arithmetical average of 500 individual measurements taken over a 100 ms period. Interruptions less than < 200 ms are ignored.		
Safety logic	Type 71.11, 71.31, 71.41, 71.51, 71.91, 71.92	Positive safety logic - When the value being monitored lies within the acceptable area, the make contact is closed.		
Reaction time (following the application of the supply voltage)	Type 71.11, 71.31, 71.41, 71.51, 71.91, 71.92	≤ 0.5 s		
Power lost to the environment	without contact load	W	4	
	with rated current	W	5	
Permitted storage temperature range		°C	-40...+85	
Protection category			IP 20	
Screw torque		Nm	0.8	
Max. wire size		solid cable	standed cable	
		mm ²	0.5...(2 x 2.5)	(2 x 1.5)
		AWG	20...(2 x 14)	(2 x 16)

E

Functions

Monitoring relay	Times										Times	Supply voltage			Module width		Contact conf.				
	1-phase 230 V, Under/Overvoltage	3-phase 400 V, Under/Overvoltage	3-phase 400 V, Phase/Symmetry	3-phase 400 V, Phase loss	3-phase 400 V, Phase	DC voltage (15...700)V Under and Over voltage monitoring	AC voltage (15...484)V Under and Over voltage monitoring	DC current (0.1...10)A Under and Over current monitoring	AC current (0.1...10)A (for to 600 A with current transformers) Under and Over current monitoring	Thermistor relay (PTC)		Adjustable	Fault memory for 71.41 and 71.51	Delay time 5/10 min	Delay time (0.1...12)s adjustable	Power-up activation time delay (0.1...20)s - starting inrush current suppression		24 V AC/DC	230 V AC	400 V AC	35 mm wide
E 71.11.8.230.0010	•											•				•					1 CO SPDT
71.11.8.230.1010	•									•		•				•					1 CO SPDT
71.31.8.400.1010		•								•		•				•					1 CO SPDT
71.31.8.400.1021		•								•	•		•			•					1 CO SPDT
71.31.8.400.2000			•	•	•					•						•					1 CO SPDT
71.41.8.230.1021	•					•	•			•	•		•			•					1 CO SPDT
71.51.8.230.1021							•	•		•	•		•	•		•					1 CO SPDT
71.91.0.024.0300									•	•					•				•		1 NO SPST-NO
71.91.8.230.0300									•	•					•				•		1 NO SPST-NO
71.92.0.024.0001									•	•	•				•				•		2 CO DPDT
71.92.8.230.0001									•	•	•				•				•		2 CO DPDT
Current transformer	Source as required																				

Explanation of relay marking and LED/LCD display

Monitoring relay without LCD-display

ON	LED green steady light: supply voltage is on and measuring system is active.
DEF	Default: the detected value is outside of the acceptable range (asymmetric is shown by the LED ASY). LED red flashing: delay time is running, see the function diagram. LED red steady light: output relay is off, contact 11-14 (6-2) is open.
ASY	Phase asymmetry is outside of the predefined range. LED steady light: output relay is turned off, contact 11-14 (6-2) is open.
LEVEL	Selected range as % value.
TIME	Delay time min (minutes) or s (seconds).
MEMORY ON	Fault memory switched on: the state of the output relay after the occurrence of a fault –contact 11-14 (6-2) open– will be maintained, monitored value returns to within acceptable limits. Fault reset is made by switch manipulation from ON to OFF to ON, or by power down (71.31.8.400.1021 & 71.92.x.xxx.0001), or by operating of the “RESET” (71.92.x.xxx.0001).
MEMORY OFF	Fault memory turned off: the state of the output contacts will only remain in the “fault” condition –contact 11-41 (6-2) open– while the monitored value is outside of the acceptable limits. When the monitored value returns within the acceptable limits the contact will revert to the energised state. Monitored equipment will start again automatically.

Monitoring relay with LCD-display

SET/RESET	Relay 71.41 and 71.51. Sets and resets the programmable values - see operating in the packing.		
SELECT	Relay 71.41 and 71.51. Selects the desired parameter for programming - see operating instructions.		
DEF	Default, LED red steady or flashing.		
PROG Modus	Enter the programming mode by simultaneously pressing the buttons “SET/RESET” and “SELECT” for 3 seconds. The word “prog” is shown for 1 second. “SELECT” allows the choice of “AC” or “DC”, and is confirmed with “SET/RESET”. Successively pressing the button “SELECT” brings up the choices of Up, or U_{pLo} . The appropriate choice is made by pressing the “SET/RESET” button. The next step will program the appropriate values and the selection of the fault memory function (which is selected with a “YES” or “NO”). If all programming steps are completed the display will read “end”.		
Short programmin instruction	After repeatedly pressing the “SET/RESET” button the measured value will be displayed, or “0” appears if nothing is connected to Z1 and Z2 (5 and 9). If the programming is broken off before “end” is shown in the display the previous program will remain unchanged after an interruption of the supply voltage.		
Program query	Pushing the “SELECT” button for at least 1 second, enters the “program inquiry mode”. The programmed mode and the values are shown on the repeated pressing of the “SELECT” button.		
Flashing M (memory)	Fault memory has had effect (fault acknowledgement and reset is made by a 1 second press of the “SET/RESET” button).		
LCD-display	V = volt A = amp Up = upper limit (with hysteresis in down direction) Lo = lower limit (with hysteresis in up direction) U_{pLo} = upper and lower limit - range detecting	Level = value Hys = hysteresis M = memory (fault) Yes = yes - with memory no = no - without memory	$t_1 = T_1$ - time during which short-time fluctuations are not taken into account $t_2 = T_2$ - (monitoring relay 71.51) the time during which inrush currents are not taken into account

E

LED/LCD status announcement/advice

Type	Starting mode	Normal operation	Abnormal mode	Reset	
71.11.8.230.0010 71.11.8.230.1010 71.31.8.400.1010	After connecting T = 5 or 10 min 11-14 open	Normal operation Set point is OK 11-14 is closed	Time T runs Set point is immaterial 11-14 is open Will close after T, if set point is OK	After expiry of T Set point is not OK 11-14 is open Will close, if set point is OK	
71.31.8.400.1021 Memory OFF 		Normal operation Set point is OK 11-14 is closed	Time T runs Set point is not OK 11-14 is closed	After expiry of T Set point is not OK 11-14 is open Will close, if set point is OK	
71.31.8.400.1021 Memory ON 		Normal operation Set point is OK 11-14 is closed	Time T runs Set point is not OK 11-14 is closed	After expiry of T Set point is not OK 11-14 is open Will not close at RESET	After expiry of T Set point is OK 11-14 is open Will close at RESET
71.31.8.400.2000		Normal operation Set point is OK 11-14 is closed	Supply voltage to A1(1) and/or A2(5) is missing 11-14 is open Will close if supply voltage restored and set point OK Incorrect phase rotation or phase failure or voltage A1(1) and/or A2(5) is > 1.11 U _N 11-14 is open Will close, if set point is OK	Phase asymmetry 11-14 is open 	
71.41.8.230.1021 Memory OFF		Measured value displayed Normal operation Set point is OK 11-14 is closed	Measured value displayed Time T runs, Set point is not OK 11-14 is closed	Measured value displayed After expiry of T Set point is not OK 11-14 is open Will close, if set point is OK	
71.41.8.230.1021 Memory ON		Measured value displayed Normal operation Set point is OK 11-14 is closed	Measured value displayed Time T runs, Set point is not OK 11-14 is closed	M in the display flashes Measured value displayed After expiry of T Set point is not OK 11-14 is open Will not close at RESET	M in the display - static Measured value displayed After expiry of T Set point is not OK 11-14 is open Will close at RESET
71.51.8.230.1021 Memory OFF	Measured value displayed Time T2 runs, Set point immaterial 11-14 is closed	Measured value displayed Normal operation Set point is OK 11-14 is closed	Measured value displayed Time T runs, Set point is not OK 11-14 is closed	Measured value displayed After expiry of T Set point is not OK 11-14 is open Will close, if set point is OK	
71.51.8.230.1021 Memory ON	Measured value displayed Time T2 runs, Set point immaterial 11-14 is closed	Measured value displayed Normal operation Set point is OK 11-14 is closed	Measured value displayed Time T runs, Set point is not OK 11-14 is closed	M in the display flashes Measured value displayed After expiry of T Set point is not OK 11-14 is open Will not close at RESET	M in the display - static Measured value displayed After expiry of T Set point is not OK 11-14 is open Will close at RESET
71.91.x.xxx.0300		Normal operation Set point is OK 11-14 is closed	Temperature to high or PTC line break or PTC short circuit 11-14 is open Will close, if set point is OK		
71.92.x.xxx.0001 Memory OFF		Normal operation Set point is OK 11-14 is closed	Temperature to high or PTC line break or PTC short circuit 11-14 is open Will close, if set point is OK		
71.92.x.xxx.0001 Memory ON 		Normal operation Set point is OK 11-14 is closed	Temperature to high or PTC line break or PTC short circuit 11-14 is open	Temperature is OK 11-14 is open Will close at RESET	

Functions

<p>Type 71.11.8.230.0010</p> <p>U = 230 V AC (50/60 Hz) U: (0,75...1,2)U_N Fixed limits</p> <p>10 min T 5 min</p>		<p>Switch off Immediately if monitored value is outside of the set points.</p> <p>Switch on After expiry of the time T and if monitored value is within the set points.</p> <p>C = output contact Normally open 11-14 (6-2) closed.</p>
<p>Type 71.11.8.230.1010</p> <p>U = 230 V AC (50/60 Hz) ΔU%</p> <p>10 min T 5 min</p>		<p>Switch off Immediately if monitored value is outside of the set points.</p> <p>Switch on After expiry of the time T and if monitored value is within the set points.</p> <p>C = output contact Normally open 11-14 (6-2) closed, all values within the set points.</p>
<p>Type 71.31.8.400.1010</p> <p>U = 400 V AC 3~ (50/60 Hz) ΔU%</p> <p>10 min T 5 min</p>		<p>Switch off Immediately if monitored value is outside of the set points.</p> <p>Switch on After expiry of the time T and if monitored value is within the set points.</p> <p>C = output contact Normally open 11-14 (6-2) closed.</p>
<p>Type 71.31.8.400.1021</p> <p>U = 400 V AC 3~ (50/60 Hz) ΔU% 0.1 s T 12 s</p> <p>Memory ON OFF</p>	<p>MEMORY OFF MEMORY ON</p> <p>* RESET MEMORY = By power-down or switch manipulation from ON to OFF to ON</p>	<p>Switch off If monitored value is outside of the set points and time T has elapsed.</p> <p>Switch on - MEMORY OFF Immediately monitored value returns within limits (off-set by 1% hysteresis).</p> <p>Switch on - MEMORY ON As above, but subject to the RESET operation having been actioned.</p> <p>RESET By Memory switch manipulation from ON to OFF and back to ON, or power down.</p> <p>C = output contact Normally open 11-14 (6-2) closed.</p>

Functions

Type 71.31.8.400.2000

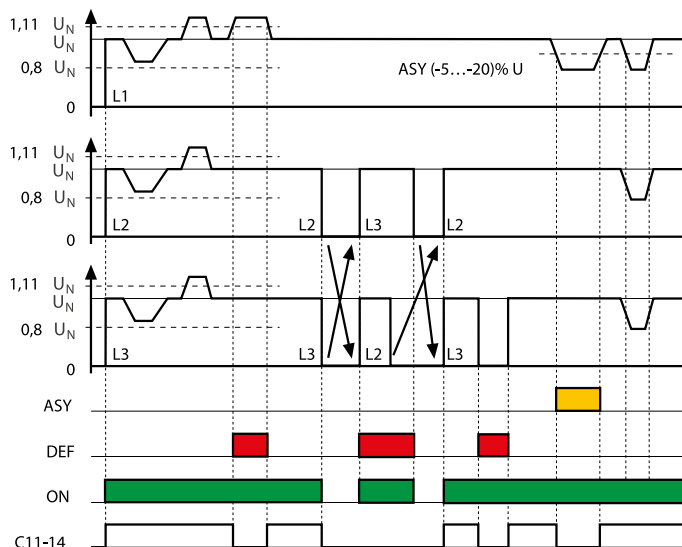
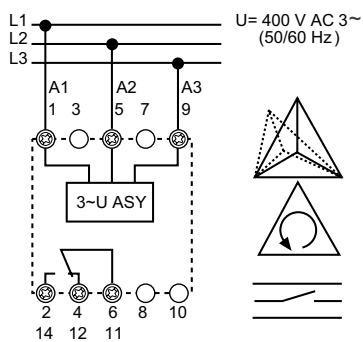

Switch off
Phase asymmetry
Incorrect phase rotation
Phase loss

LED - ASY yellow
Phase asymmetry

LED - DEF red
Voltage to A1 (1) and/or A2 (5) > 1.11 U_N

LED - ON green
Monitoring system is active and 400 V supply voltage is connected to 1-5 or A1-A2.

C = output contact
Normally open 11-14 (6-2) closed.

E

Type 71.41.8.230.1021

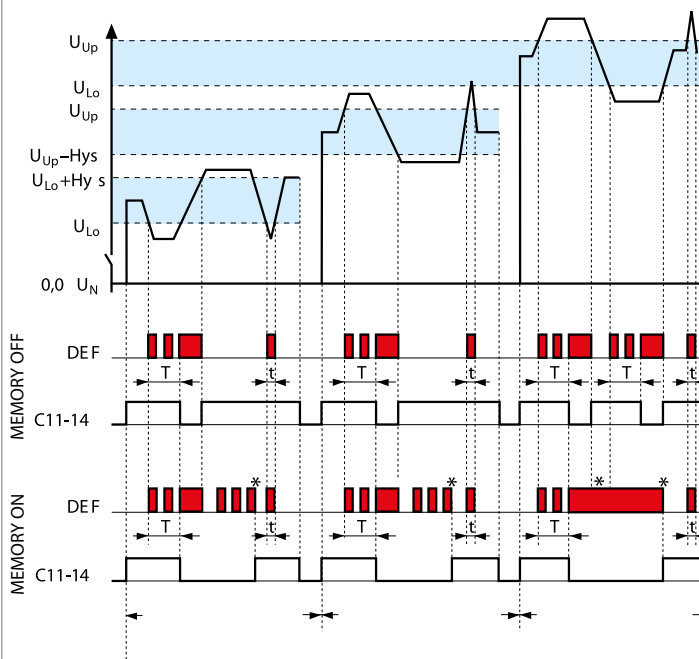
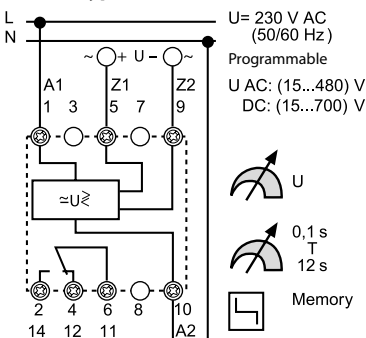

Switch off
U_{Lo} - mode
If the monitored value is less than the lower-limit and, time T has expired.

U_{Up} - mode
If the monitored value is higher than the upper limit, and time T has expired.

U_{Lo} U_{Up} - mode
If the monitored value of voltage is outside of the upper or lower voltage limits, and time T has expired.

Voltage dips < T do not result in output relay switching off.

Switch on
U_{Lo} or U_{Up} - modes
When passing the hysteresis value.

U_{Lo} U_{Up} - mode
When passing the U_{Lo} or U_{Up} value.

RESET MEMORY
Pressing "SET/RESET" > 1 sec.

C = output contact
Normally open 11-14 (6-2) closed.

* RESET MEMORY = Pressing "SET/RESET" > 1 s

Functions

Type 71.51.8.230.1021

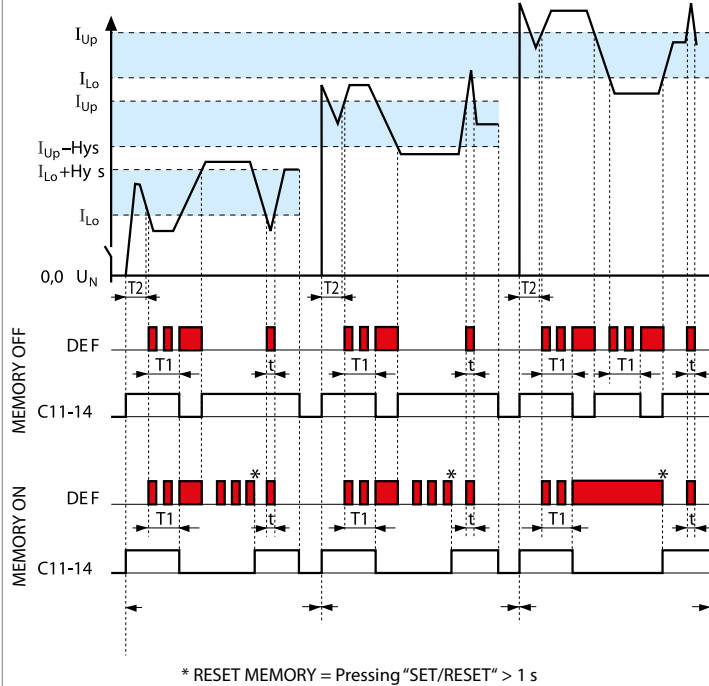
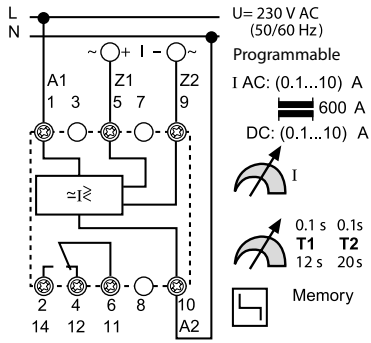

* RESET MEMORY = Pressing "SET/RESET" > 1 s

Switch off

ILo - mode
If the monitored value is less than the lower-limit and, time T1 has expired.

IUp - mode
If the monitored value is higher than the upper limit, and time T1 has expired.

ILo IUp - mode
If the monitored value of voltage is outside of the upper or lower limits, and time T1 has expired.

Inrush current < T2 is ignored

Current dips < T1 do not result in output relay switching off.

Switch on

ILo or IUp - modes
When passing the hysteresis value.

ILo IUp - mode
When passing the ILo or IUp value.

RESET MEMORY

Pushing "SET/RESET" > 1 sec.

C = output contact

Normally open 11-14 (6-2) closed.

Type 71.91.x.xxx.0300

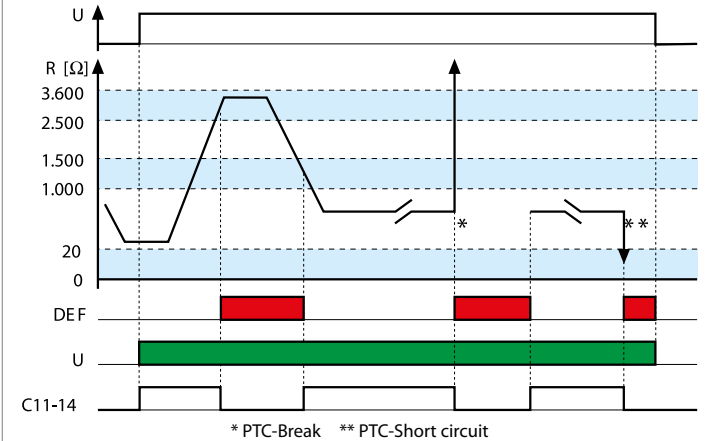
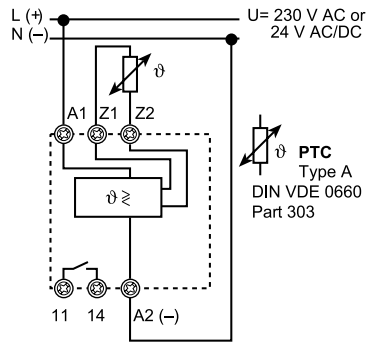

* PTC-Break ** PTC-Short circuit

Switch off

- Thermistor line break
- Over temperature $R_{PTC} > (2.5...3.6)k\Omega$
- Thermistor line short circuit ($R_{PTC} \leq 20 \Omega$)
- Loss of supply

Switch on

Temperature within limits
 $R_{PTC} > (1.0...1.5)k\Omega$ on power-up.
 $(1...1.5)k\Omega$ on cooling.

C = output contact

Normally open 11-14 Closed when temperature within limits.

Functions

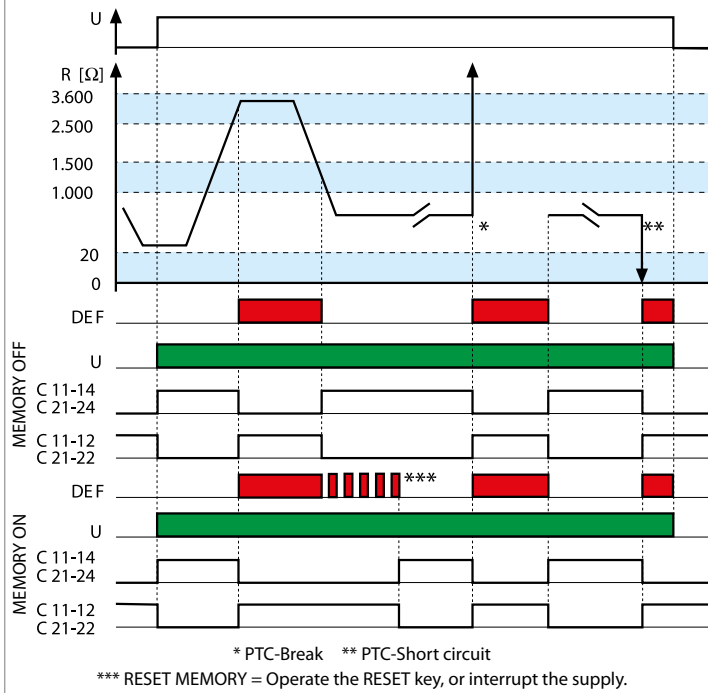
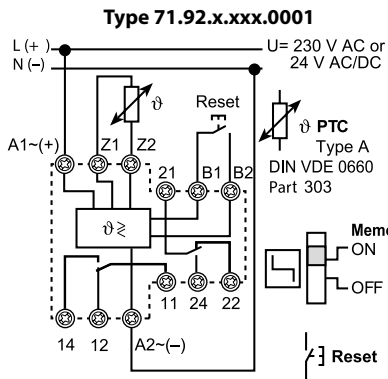

Switch off

- Thermistor line break
- Over temperature
 $R_{PTC} > (2.5 \dots 3.6)k\Omega$,
- Thermistor line short circuit ($R_{PTC} < 20 \Omega$)
- Loss of supply

Switch on

Temperature within limits
($20 \Omega \dots 2.5 k\Omega$)
on power-up.
 $R_{PTC} > (1 \dots 1.5)k\Omega$ on cooling.

Select MEMORY OFF

If monitored value is expected to cross the resetting threshold.

Select MEMORY ON

If monitored value is expected to remain within limits.

RESET MEMORY

Operate the RESET key, or interrupt the supply.

C = output contact

Normally open 11-14 (21-24)
Closed when temperature within limits.

Normally closed 11-22 (21-22)
Closed when temperature outside limits/Power off.

E

Monitoring relays and float switch

72
SERIES



Industrial washing machines



Swimming pools



Control and management of water



Bottling plant



Milk processing plant



Control panels for pumps



Level control relays for conductive liquids

Type 72.01

- Adjustable sensitivity
- Available also for supply 400 V
- Available also with sensitivity range (5...450)kΩ adjustable
- Available also for contact loads down to 5 V, 1 mA

Type 72.11

- Fixed sensitivity
- Emptying or filling functions
- LED indicator
- Reinforced insulation (6 kV - 1.2/50 μs) between:
 - supply and contacts
 - electrodes and supply
 - contacts and electrodes
- 35 mm rail (EN 60715) mount
- Control about a single level or between Min./Max. limits

72.01/11
Screw terminal



FOR UL RATINGS SEE:
"General technical information" page V

For outline drawing see page 10

Contact specification

Contact configuration		1 CO (SPDT)
Rated current/Maximum peak current	A	16/30
Rated voltage/ Maximum switching voltage	V AC	250/400
Rated load AC1	VA	4000
Rated load AC15 (230 V AC)	VA	750
Single phase motor rating (230 V AC)	kW	0.55
Breaking capacity DC1: 30/110/220 V	A	16/0.3/0.12
Minimum switching load	mW (V/mA)	500 (10/5)
Standard contact material		AgCdO

Supply specification

Nominal voltage (U _N)	V AC (50/60 Hz)	24	110...125	230...240	400
	V DC	24	—	—	—
Rated power AC/DC	VA (50 Hz)/W	2.5/1.5			
Operating range	V AC (50/60 Hz)	19.2...26.4	90...130	184...253	360...460
	V DC	20.4...26.4	—	—	—

Technical data

Electrical life at rated load AC1	cycles	100 · 10 ³
Electrode voltage	V AC	4
Electrode current	mA	0.2
Run-on time	s	0.5 - 7 (selectable)
Max sensitivity range	kΩ	5...150 (adjustable)
Insulation between supply/contacts/electrode (1.2/50 μs)	kV	6
Ambient temperature	°C	-20...+60
Protection category		IP 20

Approvals (according to type)

72.01



- Sensitivity range (5...150)kΩ adjustable
- Delay time (0.5 s or 7 s) switch selectable
- Emptying or filling functions switch selectable

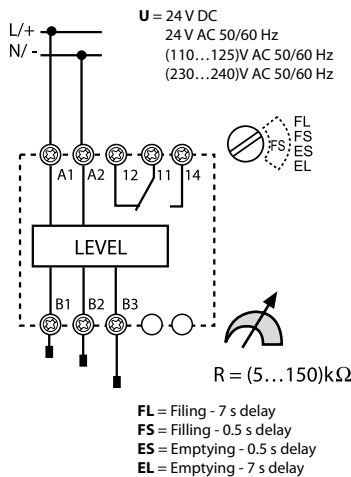

72.11



- Sensitivity fixed 150 kΩ
- Delay time fixed: 1 s
- Emptying or filling functions link selectable

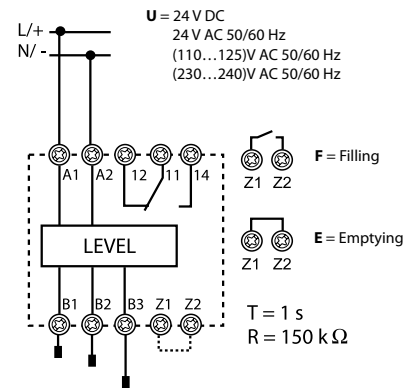

Special relay for alternating loads, for applications with pumps, compressors, air conditioning or refrigeration units

Type 72.42

- Priority change relay
- 2 independent NO output, 12 A
- 4 functions
- 2 independent control signals, insulated from supply
- 110...240 V and 24 V AC/DC supply versions
- Modular housing, 35 mm wide
- 35 mm rail (EN 60715) mount
- Cd-free contact material

72.42
Screw terminal



E

72.42



- Multi-function (M1, ME, M2, M1)

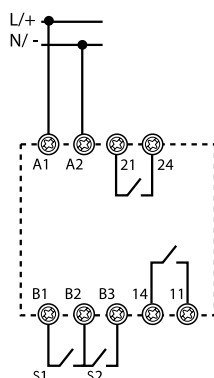

For outline drawing see page 10

Contact specification

Contact configuration	2 NO (2 DPST-NO)	
Rated current/Max. peak current	A	12/20
Rated voltage/ Max. switching voltage	V AC	250/400
Rated load AC1	VA	3000
Rated load AC15	VA	1000
Single phase motor rating (230 V AC)	kW	0.55
Breaking capacity DC1: 30/110/220 V	A	12/0.3/0.12
Minimum switching load	mW (V/mA)	300 (5/5)
Standard contact material	AgNi	

Supply specification

Nominal voltage (U _N)	V AC (50/60 Hz) / DC	24	110...240
Rated power	in stand-by W	0.12	0.18
	with 2 active relays W/VA(50 Hz)	1.1/1.7	1.5/3.9
Operating range	V AC (50/60 Hz)	16.8...28.8	90...264
	V DC	16.8...32	90...264

Technical data

Electrical life at rated load AC1	cycles	100 · 10 ³
Output delay time (T on function diagrams)	s	0.2...20
Power-on activation time	s	≤ 0.7
Minimum impulse duration	ms	50
Insulation between supply and contacts (1.2/50 μs)	kV	6
Dielectric strength between open contacts	V AC	1000
Ambient temperature	°C	-20...+50
Protection category	IP 20	

Approvals (according to type)



Ordering information

Example: 72 series level control relay, adjustable sensitivity range, (230...240)V AC supply voltage.

7 2 . 0 1 . 8 . 2 4 0 . 0 0 0 0

Series

Type

- 0 = Level control relay, sensitivity range adjustable (5...150)kΩ
- 1 = Level control relay, sensitivity fixed 150 kΩ
- 4 = Priority change relay

No. of poles

- 1 = 1 CO (SPDT)
- 2 = 2 NO (DPST-NO)

Contact material

- 0 = Standard AgCdO for 72.01/72.11, AgNi for 72.42
- 5 = AgNi + Au**

Supply voltage

- 024 = 24 V
- 125 = (110...125)V AC
- 230 = (110 ... 240)V
- 240 = (230...240)V AC
- 400 = 400 V AC (72.01 only)

Supply version

- 0 = DC/AC (50/60 Hz)
- 8 = AC (50/60 Hz)
- 9 = DC

All versions

- 72.01.8.024.0000
- 72.01.8.024.0002*
- 72.01.8.125.0000
- 72.01.8.240.0000
- 72.01.8.240.0002*
- 72.01.8.240.5002**
- 72.01.8.400.0000
- 72.01.9.024.0000
- 72.11.8.024.0000
- 72.11.8.125.0000
- 72.11.8.240.0000
- 72.11.9.024.0000
- 72.42.0.230.0000
- 72.42.0.024.0000

Option

- 0 = Max. 150 kΩ
- 2 = Sensitivity range adjustable (5...450)kΩ types 72.01.8.024.0002* 72.01.8.240.0002* 72.01.8.240.5002**

* For liquids conductivity up to 2 μ Siemens or a Resistance of 450 kΩ

** For applications with output contact loading down to 5 V, 1 mA



Technical data

Insulation			72.01/72.11	72.42	
Insulation		Dielectric strength	Impulse (1.2/50 µs)		
		between supply and contacts	4000 V AC	6 kV	6 kV
		between supply and control (for 110...240 V version only)	2500 V AC	—	4 kV
		between electrodes, Z1-Z2 and supply*	4000 V AC	6 kV	—
		between contacts and electrodes	4000 V AC	6 kV	—
	between open contacts	1000 V AC	1.5 kV	1.5 kV	
EMC specifications					
Type of test		Reference standard	72.01/72.11	72.42	
Electrostatic discharge	contact discharge	EN 61000-4-2	4 kV	4 kV	
	air discharge	EN 61000-4-2	8 kV	8 kV	
Radio-frequency electromagnetic field	(80...1000 MHz)	EN 61000-4-3	10 V/m	10 V/m	
	(1...2.8 GHz)	EN 61000-4-3	—	5 V/m	
Fast transients (burst 5/50 ns, 5 and 100 kHz)	on supply terminals	EN 61000-4-4	4 kV	4 kV	
	on control terminals	EN 61000-4-4	—	4 kV	
Voltage pulses on supply terminals (surge 1.2/50 µs)	common mode	EN 61000-4-5	4 kV	4 kV	
	differential mode	EN 61000-4-5	4 kV	4 kV	
Radiofrequency common mode voltage (0.15...280 MHz)	on supply terminals	EN 61000-4-6	10 V	10 V (0.15...230 MHz)	
	on control terminals	EN 61000-4-6	—	10 V	
Voltage dips	70% U _N	EN 61000-4-11	—	25 cycles	
Short interruptions		EN 61000-4-11	—	1 cycles	
Radiofrequency conducted emissions	(0.15...30 MHz)	CISPR 11	class B	class B	
Radiated emissions	(30...1000 MHz)	CISPR 11	class B	class B	
Terminals					
 Screw torque	Nm	0.8			
Wire strip length	mm	9			
Max. wire size		solid cable	stranded cable		
	mm ²	1 x 6 / 2 x 4	1 x 4 / 2 x 2.5		
	AWG	1 x 10 / 2 x 12	1 x 12 / 2 x 14		
Other data					
Current absorption on Z1 and Z2 (type 72.11)	mA	< 1			
Current absorption on control signal (B1-B2 and B2-B3) - (type 72.42)		5 mA, 5 V			
Power lost to the environment		72.01/72.11	72.42		
	without contact current	W	1.5	0.9 (1 relay ON)	
	with rated current	W	3.2	3.0 (2 relays ON)	
Max cable length between electrode and relay (types 72.01/72.11)	m	200 (max. capacitance of 100 nF/km)			

* There is no electrical isolation between electrodes and supply voltage for the 24 V DC types (72.x1.9.024.0000). Therefore, for SELV applications it would be necessary to use a SELV (non-grounded) power supply. In the case of a PELV (grounded) power supply take care to protect the level control relay against harmful circulating currents by ensuring that no electrodes are grounded.

However, there is no such problem for the 24 V AC types (72.x1.8.024.0000) which, by virtue of an internal isolating transformer, assure reinforced isolation between electrodes and supply.

Functions for 72.01 and 72.11

- U** = Supply voltage
- B1** = Max level electrode
- B2** = Min level electrode
- B3** = Common
- = Contact 11-14
- Z1-Z2** = Link to select emptying (Type 72.11)

LED	Supply voltage	NO output contact	Contacts	
			Open	Closed
	OFF	Open	11 - 14	11 - 12
	ON	Open	11 - 14	11 - 12
	ON	Open (Timing in Progress)	11 - 14	11 - 12
	ON	Closed	11 - 12	11 - 14

Function and Run-on time

Type 72.01

- FL** = Level control by Filling, Long (7 s) run-on delay.
- FS** = Level control by Filling, Short (0.5 s) run-on delay.
- ES** = Level control by Emptying, Short (0.5 s) run-on delay.
- EL** = Level control by Emptying, Long (7 s) run-on delay.

Type 72.11

- F** = Level control by Filling, Z1-Z2 open. Run-on time fixed at 1 s.
- E** = Level control by Emptying, Z1-Z2 linked. Run-on time fixed at 1 s.

Filling functions

Wiring diagram

Examples with 3 electrodes

Type 72.01

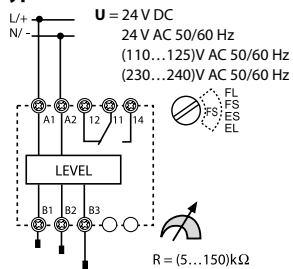

Type 72.11

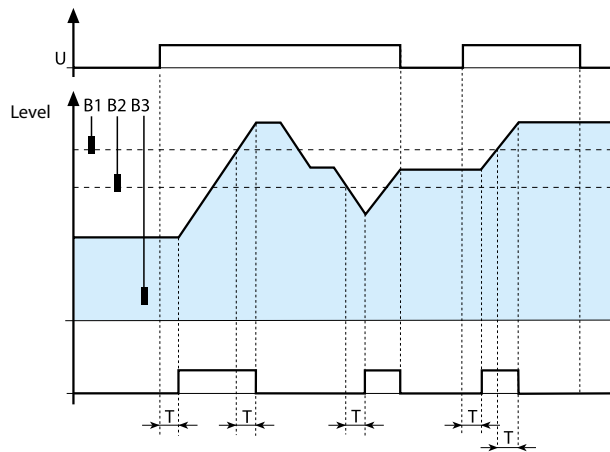
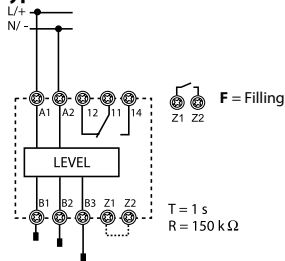

Filling Control – between Min. and Max. levels.

Under normal operation the liquid level can be expected to cycle between the Minimum and the Maximum electrodes, B2 and B1 (plus a degree of over and under-shoot).

Switch On:

- On “power-up”, if the liquid is below B1 the output relay will operate after time T has expired.
- On the liquid level falling below B2, the output relay will operate after time T has expired.

Switch Off:

- On the liquid level reaching electrode B1, the output relay will de-energise after time T has expired.
- On “power-off”, the output relay will immediately de-energise.

Wiring diagram

Examples with 2 electrodes

Type 72.01

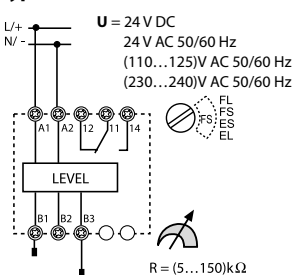

Type 72.11

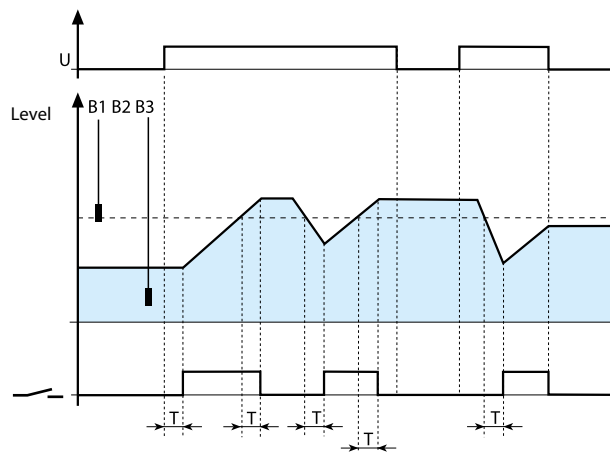
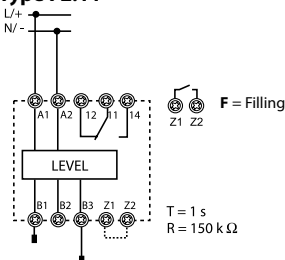

Filling Control – about a single level, B1.

Under normal operation the liquid level can be expected to cycle about the level set by electrode B1 with a degree of over and under-shoot.

Switch On:

- On “power-up”, if the liquid is below B1 the output relay will operate after time T has expired.
- On the liquid level falling below B1, the output relay will operate after time T has expired.

Switch Off:

- On the liquid level reaching electrode B1, the output relay will de-energise after time T has expired.
- On “power-off”, the output relay will immediately de-energise.

Emptying functions

Wiring diagram

Examples with 3 electrodes

Type 72.01

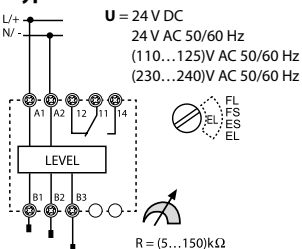

Type 72.11

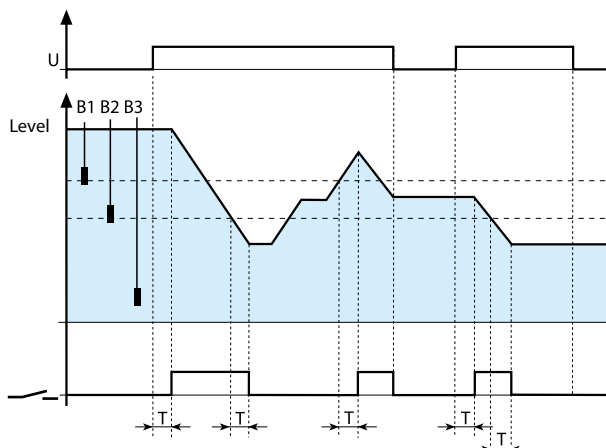
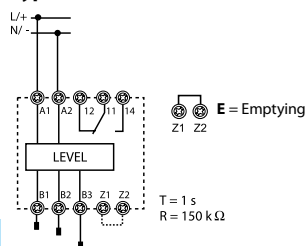

Emptying Control - between Max. and Min. levels.

Under normal operation the liquid level can be expected to cycle between the Maximum and the Minimum electrodes, B1 and B2 (plus a degree of over and under-shoot).

Switch On:

- On "power-up", if the liquid level is above B2 the output relay will operate after time T has expired.
- On the liquid level rising to B1, the output relay will operate after time T has expired.

Switch Off:

- On the liquid level falling below electrode B2, the output relay will de-energise after time T has expired.
- On "power-off", the output relay will immediately de-energise.

E Wiring diagram

Examples with 2 electrodes

Type 72.01

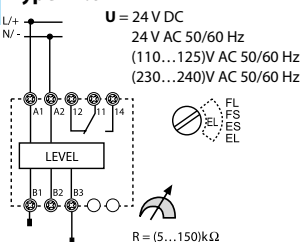

Type 72.11

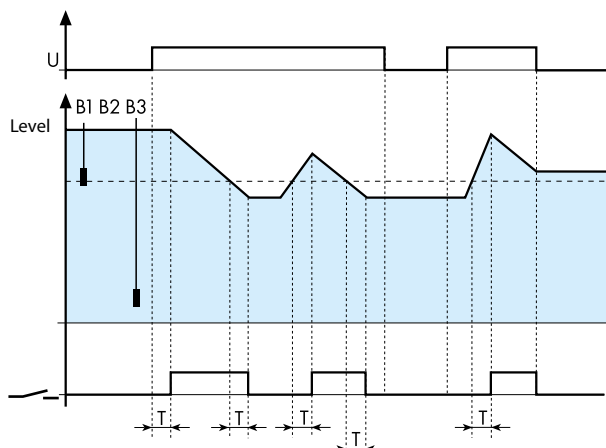
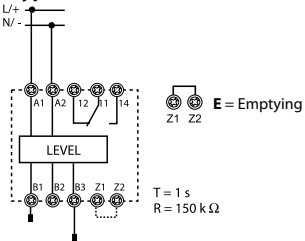

Emptying Control about a single level, B1.

Under normal operation the liquid level can be expected to cycle about the level set by electrode B1 with a degree of over and under-shoot.

Switch On:

- On "power-up", if the liquid is above B1 the output relay will operate after time T has expired.
- On the liquid level rising to B1, the output relay will operate after time T has expired.

Switch Off:

- On the liquid level falling below electrode B1, the output relay will de-energise after time T has expired.
- On "power-off", the output relay will immediately de-energise.

Applications for 72.01 and 72.11

FILLING function:

Examples with 3 electrodes and with a contactor connected to the contact.

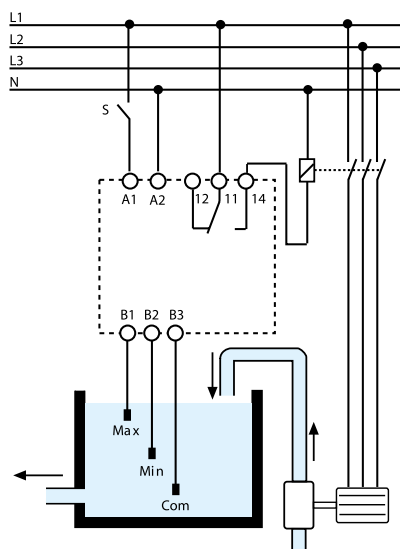

EMPTYING function:

Examples with 3 electrodes and with a motor pump connected directly to the contact.

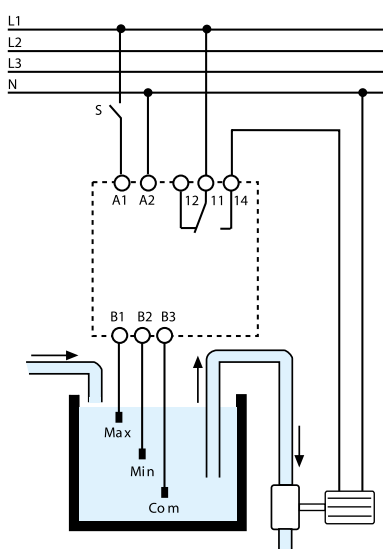

The 72 series level control relays work by measuring the resistance through the liquid, between the common (B3) electrode and Min. and Max. electrodes (B2 and B1). If the tank is metallic, then this can be substituted as the B3 electrode.

Take care to ensure that the liquid has a suitable resistivity - see below:

SUITABLE LIQUIDS

- City water
- Well water
- Rainwater
- Sea water
- Liquids with low-percentage alcohol
- Wine
- Milk, Beer, Coffee
- Sewage
- Liquids fertilizer

UN-SUITABLE LIQUIDS

- Demineralised water
- Fuels
- Oil
- Liquids with high-percentage alcohol
- Liquid gas
- Paraffins
- Ethylene glycol
- Paint

Functions for 72.42

A1-A2 = Supply voltage

S1 (B1-B2) = Control signal 1

S2 (B3-B2) = Control signal 2

= Contact 1 (11-14) and
Contact 2 (21-24)

LED 1 = Output 1

LED 2 = Output 2

LED	
	Device in stand-by, output not activated
	Output not activated, timing in progress
	Output not activated (only functions M1/M2)
	Output activated

Wiring diagram

		<p>(MI) Outputs alternate on successive applications of supply voltage</p> <ul style="list-style-type: none"> Application of the supply voltage to A1-A2 forces just one output contact to close, but the contact that closes will alternate between 11-14 and 21-24 on each successive application of the supply – ensuring even wear across both motors. The other output contact can be forced closed by the closure of either S1 or S2 - but to limit high current surges the other motor cannot start within T seconds of the first motor.
		<p>(ME) Outputs alternate according to control signal</p> <ul style="list-style-type: none"> The supply voltage is permanently applied to A1-A2. When closed, S1 forces just one output contact to close. The contact that closes will alternate between 11-14 and 21-24 on each successive S1 closure - ensuring even wear across both motors. If closed, S2 forces both output contacts to close (irrespective of S1). However, to limit high current surges, both motors cannot start within T seconds of each other.
		<p>(M2) Output 2 (21-24) only</p> <ul style="list-style-type: none"> Supply permanently applied to A1-A2. Closure of either S1 or S2 will close output contact 2 (21-24). Use when load 1 (11-14) is out of service.
		<p>(M1) Output 1 (11-14) only</p> <ul style="list-style-type: none"> Supply permanently applied to A1-A2. Closure of either S1 or S2 will close output contact 1 (11-14). Use when load 2 (21-24) is out of service.

MI function example

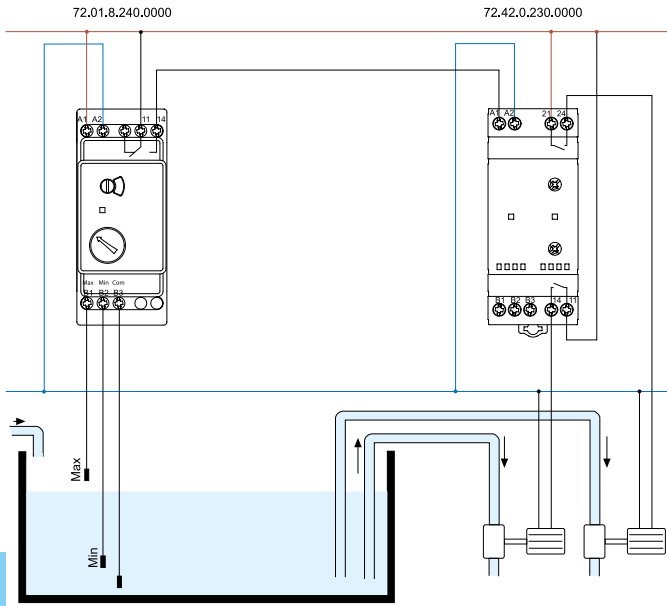

This shows the 72.42 Priority change relay working in conjunction with a single 72.01 level controller. Under normal conditions the liquid level is expected to remain within the range shown as Min to Max. In this case the function of the 72.42 will be to alternate the duty between both pumps, to even wear across both pumps. There is no provision to run both pumps simultaneously.

E

ME function example

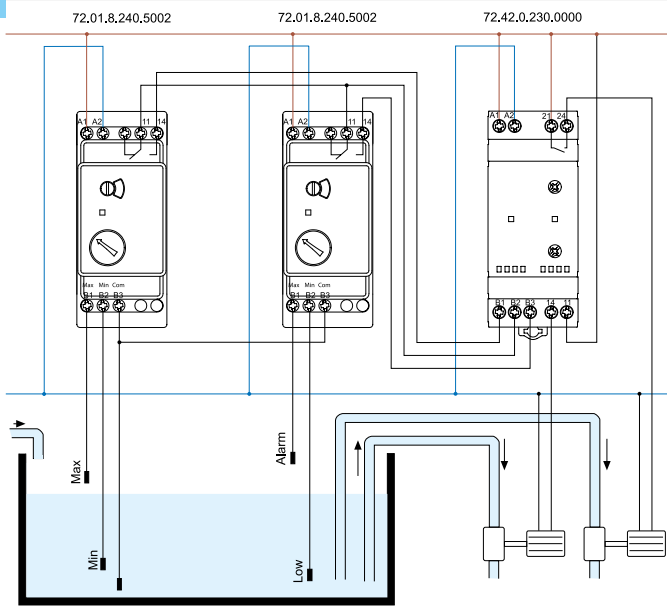

This shows the 72.42 Priority change relay working in conjunction with two 72.01 level controllers. Under normal conditions the liquid level is expected to remain within the range shown as Min to Max. In this case the function of the 72.42 will be to alternate the duty between both pumps, to even wear across both pumps. Should the liquid level rise above the Alarm level then the function of the 72.42 will call for the simultaneous operation of both pumps, by virtue of the signal to terminal B3 from the Alarm/Low level controller.

Note: due to the low level of 72.42 control signals, it is suggested to use level controller 72.01.8.240.5002 because of its superior low load switching capability.

Outline drawings

72.01/11
Screw terminal

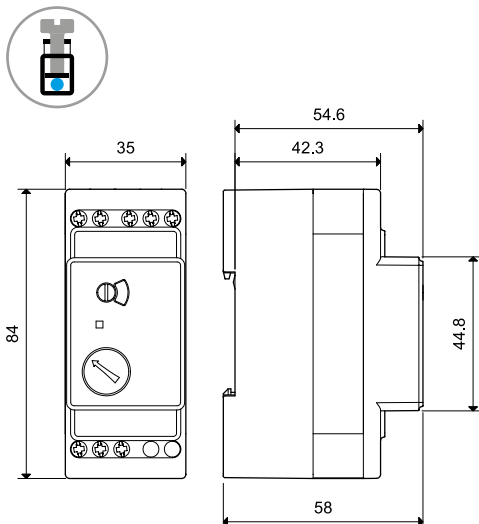

72.42
Screw terminal

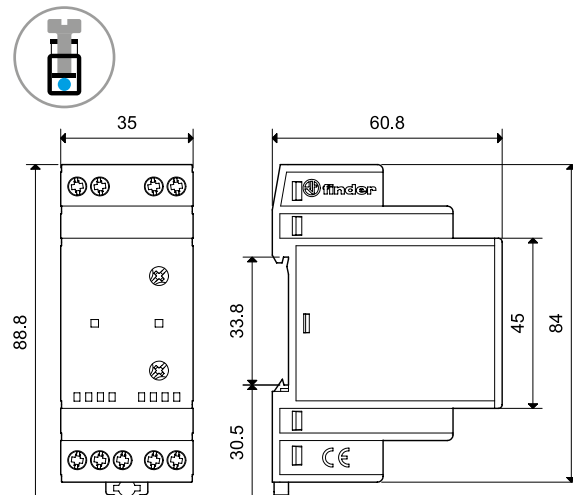

Accessories for 72.01 and 72.11



072.01.06

Suspended electrode for conductive liquids, complete with cable. Suitable for level monitoring in wells and reservoirs not under pressure.

- Electrode compatible with food processing applications (according to European Directive 2002/72 and cod. FDA title 21 part 177):

Cable length: 6 m (1.5 mm ²)	072.01.06
Cable length: 15 m (1.5 mm ²)	072.01.15



072.02.06

- Electrode for swimming pools with high levels of chlorine, or in salt-water pools with high levels of salinity:

Cable length: 6 m (1.5 mm ²)	072.02.06
--	-----------

Technical data	
Max. liquid temperature	°C +100
Electrode material	stainless steel (AISI 316L)

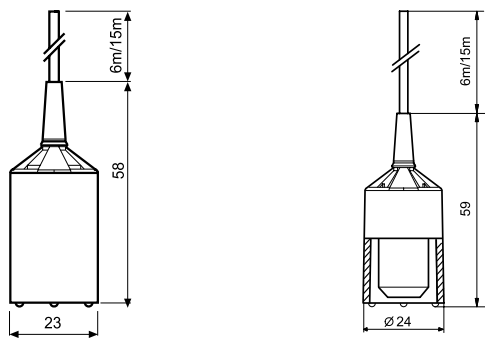

NEW

072.31

Suspended electrode	072.31
Technical data	
Max liquid temperature	°C +80
Cable grip	mm $\varnothing \leq 2.5 \dots 3.5$
Electrode material	stainless steel (AISI 316L)
Casing material	polypropylene
Max screw torque	Nm 0.7
Max. wire size	mm ² 1 x 2.5
	AWG 1 x 14
Wire strip length	mm 5...9

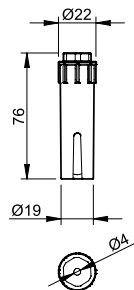

Accessories for 72.01 and 72.11



072.11

Floor water sensor , designed for the detection and reporting of the presence of floor surface water.		072.11
Technical data		
Electrode material	stainless steel (AISI 301)	
Wire capability of terminals		
Max screw torque	Nm	0.8
Max. wire size	solid cable	
	mm ²	1 x 6 / 2 x 6
	AWG	1 x 10 / 2 x 10
stranded cable		1 x 6 / 2 x 4
Wire strip length		mm 9
Other data		
Distance between electrodes and floor	mm	1
Floor fixing screw diameter	Maximum M5	
Maximum cable diameter	mm	10
Maximum length of cable connecting sensor to relay	m	200 (with capacitance of 100 nF/km)
Max. liquid temperature	°C	+100

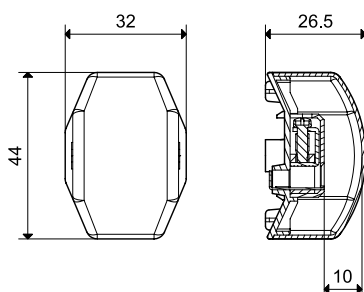

Floor surface water sensor for connection to electrode terminals (B1 and B3) of 72.01 or 72.11 level control relay, set in Emptying function (ES or E respectively).

For ice bank control in refrigeration systems it is suggested to use the high sensitivity (5...450)kΩ types - 72.01.8.024.0002 or 72.01.8.230.0002.

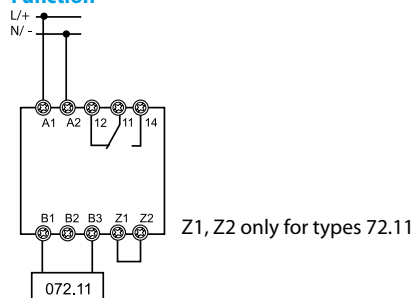
Function

072.51

Electrode holder with two pole connector , one connected directly to the electrode and the second connected to the grounded installation thread. Suitable for metal tank with G3/8" linkage. Electrode not included. Order appropriate number of electrode holders - additional to the relay.		072.51
Technical data		
Max liquid temperature	°C	+100
Max tank pressure	bar	12
Cable grip	mm	∅ ≤ 6
Electrode material	stainless steel (AISI 304)	

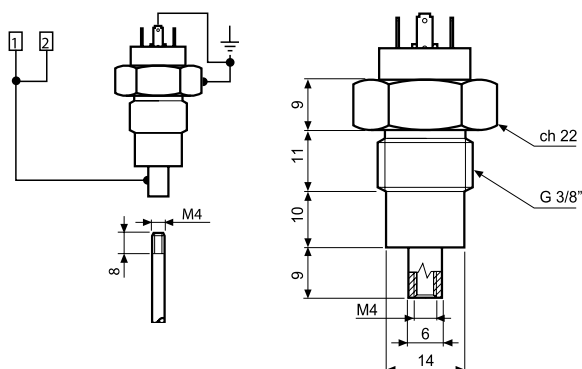

Accessories for 72.01 and 72.11



072.53

Electrode holder with three poles. Electrode not included.		
Order appropriate number of electrodes holders - additional to the relay.		072.53
Technical data		
Max liquid temperature	°C	+70
Electrode material		stainless steel (AISI 303)

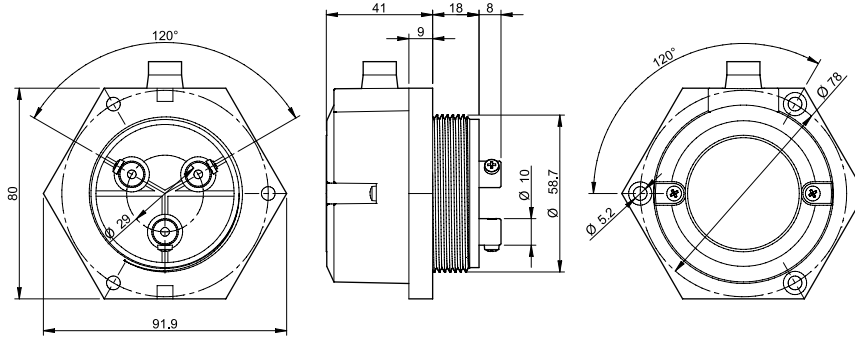

Electrode and electrode connector, multiple electrodes may be interconnected to provide required length



072.500

Technical data		
Electrode - 475 mm long, M4 thread, stainless steel (AISI 303)		072.500
Inter-electrode connector - M4 thread, stainless steel (AISI 303)		072.501

Illustration of interconnection of electrodes.



072.501



072.503

Electrode separator	072.503
----------------------------	---------



011.01

Adaptor for panel mounting, plastic, 35 mm wide	011.01
--	--------

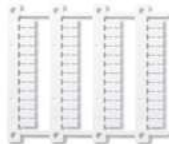
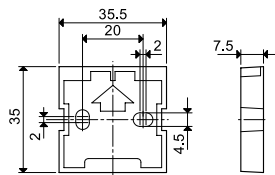

060.48

Sheet of marker tags (CEMBRE Thermal transfer printers) for relays types 72.42 (48 tags), 6 x 12 mm	060.48
--	--------



019.01

Identification tag, plastic, 1 tag, 17 x 25.5 mm (for 72.42 only)	019.01
--	--------

Application notes for 72.01 and 72.11

Applications

The main application for these relays is for the sensing and control of the level of conductive liquids.

Selectable options allow for this control to be achieved either through a filling operation or through an emptying operation, and in either case "positive logic" is used.

Level control can be achieved around a single level - using 2 electrodes, or between Minimum and Maximum levels - using 3 electrodes.

Additionally, the 72.01, with its adjustable sensitivity setting, can be ideal for monitoring the conductivity of liquids.

Positive safety logic

These relays work according to the principle that it is the closure of a normally open output contact that will be used to control the pump, both in filling and emptying applications. Consequently, in the event of a failure of the supply local to the relay, the filling or emptying will cease. This is generally considered to be the safest option.

Overrunning of tank on filling

Care must be exercised to ensure that the tank cannot overrun. Factors that have to be considered are the pump performance, the rate of discharge from the tank, the position of the single level electrode (or maximum electrode), and the run-on time delay. Keeping the time delay to a minimum will minimise the possibility of tank overrun, but will increase the installed switching rate.

Prevent dry running of pump on emptying

Care must be exercised to ensure that the pump cannot run dry. Similar considerations must be given as outlined above. In particular, keeping the run-on time delay to a minimum will minimise the risk, but again, it will increase the installed switching rate.

Run-on time

In commercial and light industrial applications the use of a short Run-on time delay is more appropriate, due to the relatively small size of tanks and the consequential need to react quickly to the change in level. Larger scale industrial applications involving larger tanks and powerful pumps must avoid a frequent switching cycle, and the use of the 72.01 set for the longer Run-on time of 7 seconds is suggested.

Note that the short run-on time will always achieve closer control to the desired level(s), but at the cost of more frequent switching.

Electrical life of the output contact

The electrical life of the output contact will be enhanced where a larger distance between the Max. and Min. electrodes (3-electrode control) can be realised. A smaller distance, or level control to a single level (2-electrode control), will result in more frequent switching and therefore a shorter electrical life for the contacts. Similarly, the long run-on time will enhance, and the short time will reduce, electrical life.

Pump control

Small single-phase pumps within the kW (0.55 kW - 230 V AC) rating stated may be driven directly by the level relay output contact. However, where very frequent switching is envisaged, it is better to "slave" a higher power relay or contactor to drive the pump motor. Large pumps (singlephase and three-phase) will of course require an interposing contactor.

Water leakage and condensation in oil lubrication systems

To detect condensed water vapour or water leakage within lubricating systems, monitor by sensors connected to B1 - B3 (Function E or ES, Z1 - Z2 linked). Condensed water vapour has low conductivity, therefore choose monitoring relay type 72.01.8.240.0002 with sensitivity range of (5...450) k Ω and sensor type 072.11.

Floor flooding control

To detect floor water due to spills or flooding, monitor using sensors connected to B1 - B3 (Function E or ES, Z1 - Z2 linked).

Choose monitoring relay type 72.01.8.240.0000 or 72.11.8.240.0000, together with floor water sensor type 072.11.

Electrodes and cable lengths

Normally 2 electrodes or 3 electrodes will be required for control about a single level, or control between Min. and Max. levels, respectively. However, if the tank is made of conductive material it is possible to use this as the common electrode, B3, if electrical connection can be made to it.

The maximum permitted length of cable between the electrode and the relays is 200m, for a cable not exceeding 100 nF/km.

A maximum of 2 relays and associated electrodes can be employed in the same tank - if two different levels need monitoring.

Note: It is permitted to make direct electrical connection between terminals B1-B3, and B2-B3, (without using electrodes/liquid), but in this case it is not possible to set up the sensitivity.

Electrode choice

The choice of electrodes may depend on the liquid being monitored. Standard electrodes 072.01.06 and 072.51 are suitable for many applications but some liquids may be corrosive for example, and may therefore require custom made electrodes - but these can usually be used with the 72.01 and 72.11 relays.

On site commissioning

To confirm the suitability of the relay sensitivity to the resistance between electrodes it is suggested that the following checks are made. For convenience it is suggested that the fill function and the shortest run-on time are selected.

Commissioning

Follow these setting-up instructions to achieve correct operation:

72.01

Select the function "FS" (Filling and Short delay of 0.5 s), and set the sensitivity control to 5 k Ω . Ensure that all electrodes are immersed in the liquid - expect the output relay to be ON. Then, slowly rotate the sensitivity control in the 150 k Ω direction until the level relay switches OFF (internal output relay will switch OFF and red LED will switch slowly flash).

(If the level relay does not switch OFF then, either the electrodes are not immersed, or the liquid has too high impedance or the distance between electrodes is too long.)

Finally, select the filling or emptying function as required, run in real time and confirm that the level relay works as required.

72.11

Select the Filling function "F", (Z1 - Z2 open). Ensure that all electrodes are immersed in the liquid, but leave electrode B3 disconnected - output relay should be ON. Connect electrode B3, and the level relay should switch OFF (internal output relay will switch OFF and red LED will switch slowly flash).

(If the level relay does not switch OFF then, either the electrodes are not immersed, or the liquid has too high impedance or the distance between electrodes is too long.)

Finally, select the filling or emptying function as required, run in real time and confirm that the level relay works as required.

Float switch suitable for fluid level regulation

- 1 CO
- 10 A (resistive load)
- 8 A (inductive load)
- 2 or 3 watertight chambers resistant to high pressures
- Cable length 5 m, 10 m, 15 m or 20 m
- Suitable for emptying and filling
- Contact material AgNi

72.A1.0000.xxxx



- Float switch with 2 watertight chambers, for grey water pumping and drainage
- Counterweight (230 g) with cable grip, included

NEW 72.A1.0000.xx02



- Float switch with 2 watertight chambers, for fluid foodstuff and potable water
- Suitable for swimming pools with high levels of chlorine, or in salt-water pools with high levels of salinity
- Counterweight (230 g) with cable grip, included
- Cable and plastics ACS certified for alimentary uses



72.B1.0000.xxxx



- Float switch with 3 watertight chambers, for black water systems, drainage plants and pumping stations
- Supplied with fixing kit

* H07 RN F cable approved TÜV

For outline drawing see page 18

Technical data

Contact configuration		1 CO	1 CO	1 CO
Rated current	A	10 A (8 A)	10 A (8 A)	10 A (8 A)
Rated voltage	V AC	250	250	250
Minimum switching load	mW (V/mA)	1200 (12/100)	1200 (12/100)	1200 (12/100)
Breaking capacity DC1		6 A - 30 V DC	6 A - 30 V DC	6 A - 30 V DC
Protection degree		IP 68	IP 68	IP 68
Max liquid temperature	°C	+50	+40	+50
Max depth	m	40	40	20
Cable material		PVC - H07 RN F*	ACS + AD8	PVC - H07 RN F*
Body material		Polypropylene	Polypropylene	Polypropylene
Approvals (according to type)		CE EAC	CE ACS	CE EAC

E

Ordering information

Example: 72 Series, float switch, 1 CO.

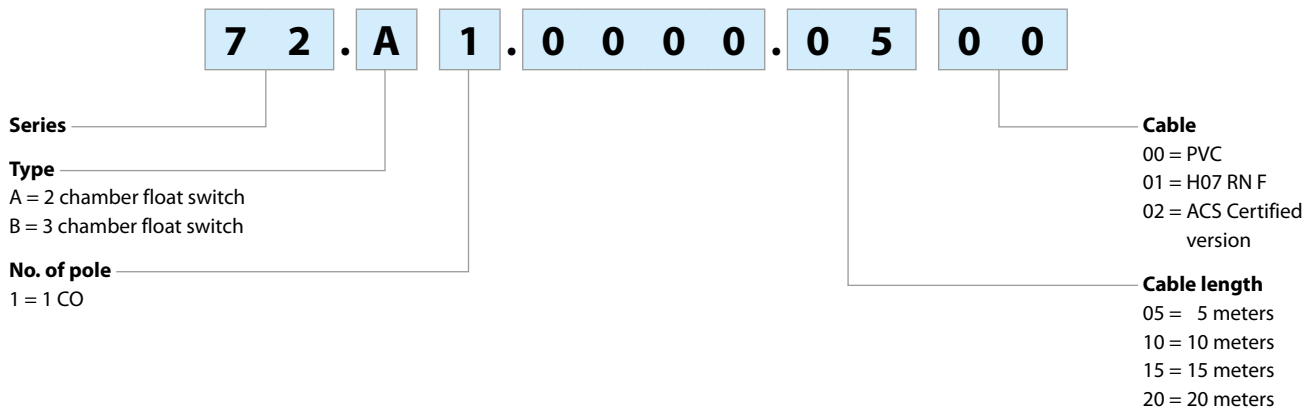

Accessories - Included in the package

Counterweight for type 72.A1



Counterweight (230 g) for Type 72.A1. Fixes to the cable to allow adjustment of the overall level and the switching hysteresis.

Fixing Kit for type 72.B1



Screw clamp with cable grommet for Type 72.B1. For "strain relief" fixing of the cable.

Applications

Type 72.A1

Emptying function

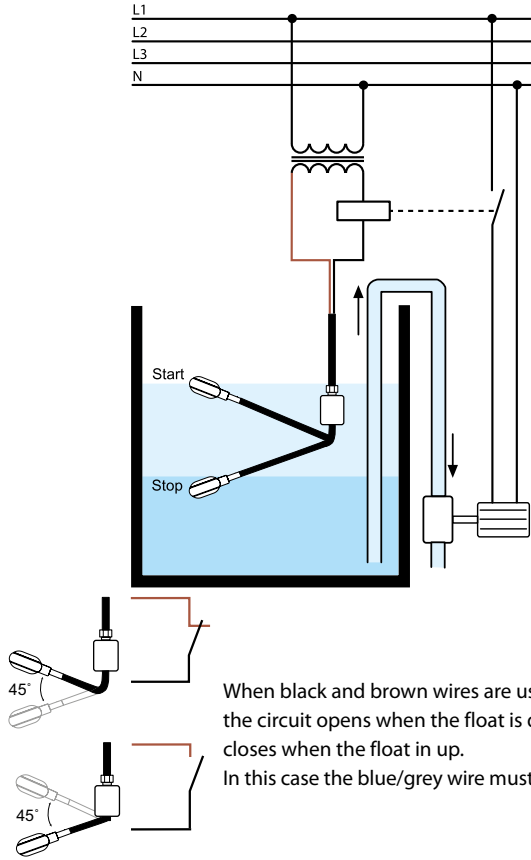

Filling function

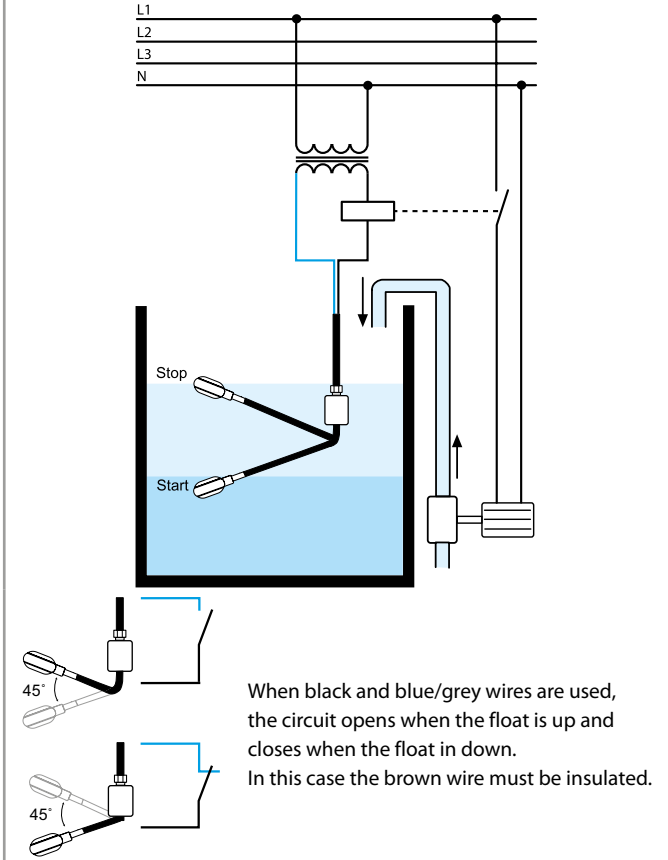

Type 72.B1

Emptying function

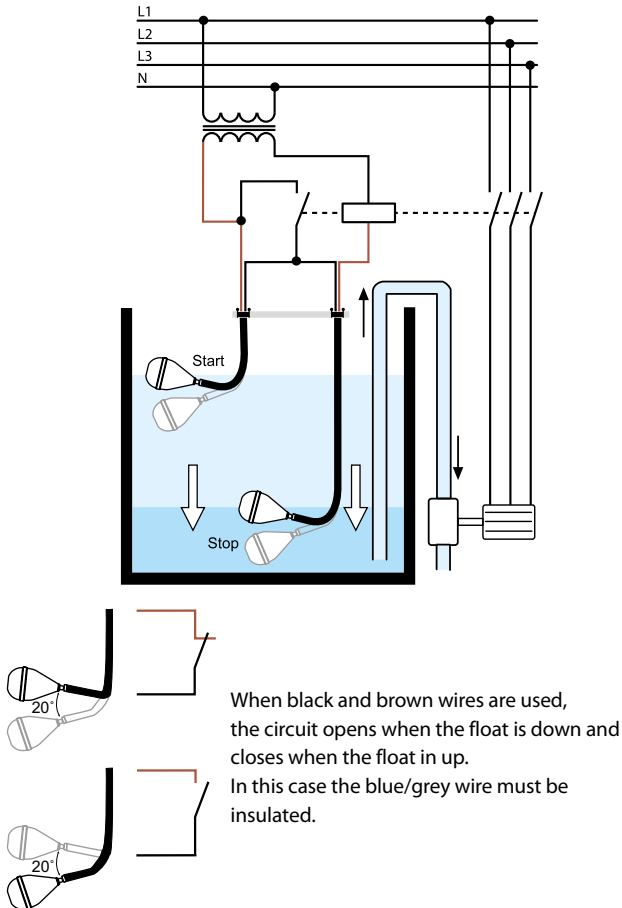

Filling function

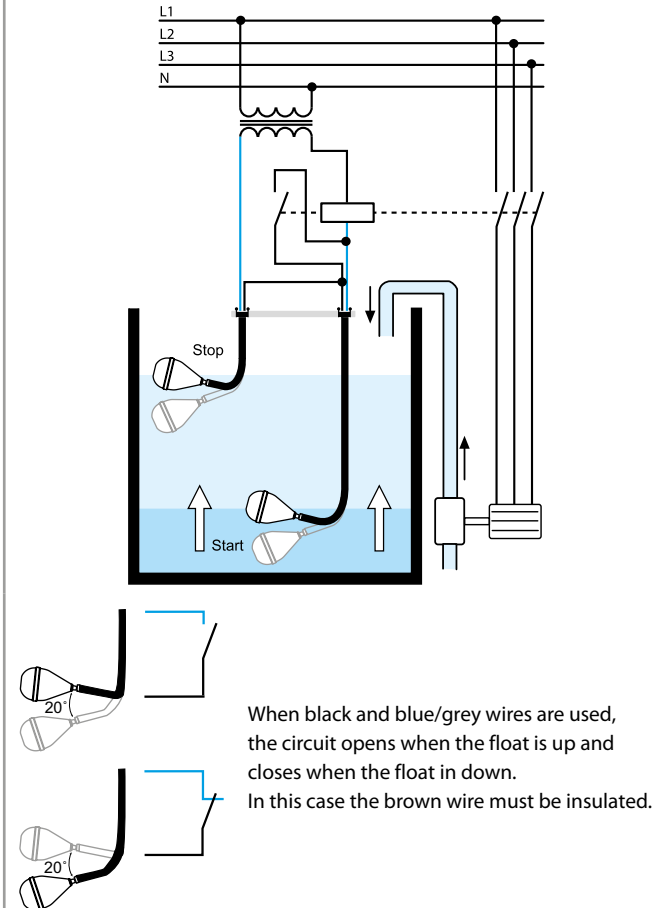

Outline drawings

Type 72.A1

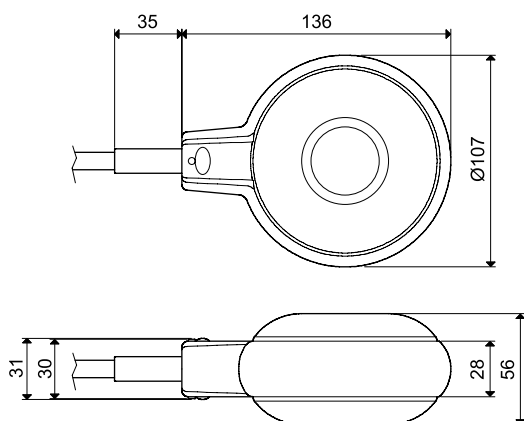

Type 72.B1

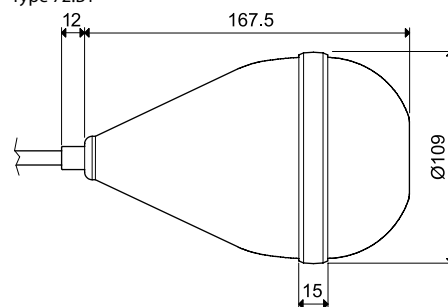



finder[®]
SWITCH TO THE FUTURE

Energy meters

7E
SERIES



Panels for electrical distribution



Control panels



Electrical energy control



Industrial robots



Road / tunnel lighting



Elevators and lifts



kWh Energy meter 1-phase with electro-mechanical display and SO pulse output

Type 7E.12.8.230.0002

10 (25) A, kWh, No MID, horizontal display

Type 7E.13.8.230.0010

5 (32) A, kWh, MID, 1 module wide

Type 7E.16.8.230.0010

10 (65) A, kWh, MID, horizontal display

- Complies with EN 62053-21 and EN 50470
- Certified by PTB (7E.13 and 7E.16) (Physikalisch - Technischen Bundesanstalt)
- Accuracy class 1/B
- Protection class II
- SO pulse output for remote energy monitoring according to EN 62053-31
- Tamper-proof cover with lead seal facility available as an accessory
- Space saving small size
- 35 mm rail (EN 60715) mount

7E.12.8.230.0002



- Nominal current 10 A (25 A Maximum)
- 1-phase 230 V AC
- SO pulse output
- 35 mm wide

7E.13.8.230.0010



- Nominal current 5 A (32 A Maximum)
- MID certified (50 Hz)
- 1-phase 230 V AC
- SO pulse output
- 17.5 mm wide

7E.16.8.230.0010



- Nominal current 10 A (65 A Maximum)
- MID certified (50 Hz)
- 1-phase 230 V AC
- SO pulse output
- 35 mm wide

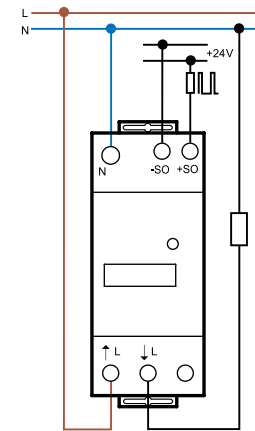
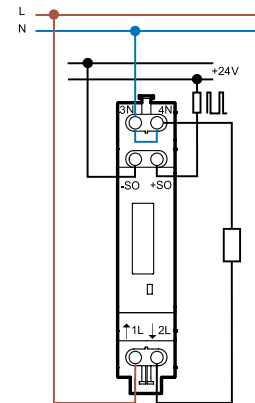
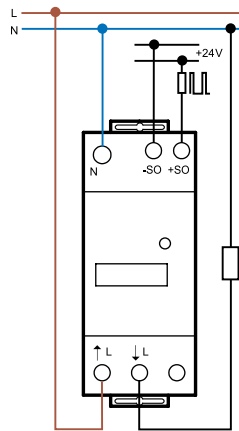

For outline drawing see page 15

Specification

Nominal/Maximum current	A	10/25	5/32	10/65
Minimum measured current	A	0.04	0.02	0.04
Current range (within accuracy class)	A	0.5...25	0.25...32	0.5...65
Maximum peak current	A	750 (10 ms)	960 (10 ms)	1950 (10 ms)
Supply (& monitored) voltage (U _N)	V AC	230	230	230
Operating range		(0.8...1.15)U _N	(0.8...1.15)U _N	(0.8...1.15)U _N
Frequency	Hz	50	50	50
Power consumption	W	< 0.5	< 0.4	< 0.5
Display (digit height 4 mm)		Six digit counter, red decimal digit	Seven digit counter, red decimal digit	
Max. totalising count/Min. increment	kWh	99 999.9/0.1	999 999.9/0.1	999 999.9/0.1
LED-Pulses per kWh		2000	2000	1000
Open collector- output specification (SO+/SO-)				
Voltage (external supply)	V DC	5...30	5...30	5...30
Maximum current	mA	20	20	20
Maximum leakage current @ 30 V/25 °C	µA	10	10	10
Pulses per kWh		1000	1000	1000
Pulse length	ms	50	50	50
Internal series resistance	Ω	100	100	100
Maximum cable length @ 30 V/20 mA	m	1000	1000	1000
Technical data				
Accuracy class		1	B	B
Ambient temperature (Within accuracy class)	°C	-10...+55	-10...+55	-10...+55
Protective class		II	II	II
Protection category: Housing/terminals		IP 50/IP 20	IP 50/IP 20	IP 50/IP 20
Approvals (according to type)		CE	CE PTB	

**kWh Energy meter 3-phase
MID with electromechanical display and SO
pulse output**

Type 7E.36.8.400.0010

10 (65) A, kWh, MID

Type 7E.36.8.400.0012

10 (65) A, kWh, dual tariff, MID

- Complies with EN 62053-21 and EN 50470
- Certified by PTB (Physikalisch - Technischen Bundesanstalt)
- Accuracy class B
- Protection class II
- SO pulse output for remote energy monitoring according to EN 62053-31
- Tamper-proof cover with lead seal facility available as an accessory
- 35 mm rail (EN 60715) mount

7E.36.8.400.0010



- Nominal current 10 A (65 A Maximum)
- MID certified (50 Hz)
- 3-phase
- SO pulse output
- 70 mm wide

7E.36.8.400.0012



- Nominal current 10 A (65 A Maximum)
- MID certified (50 Hz)
- 3-phase
- SO pulse output
- Dual tariff (Day and Night)
- 70 mm wide

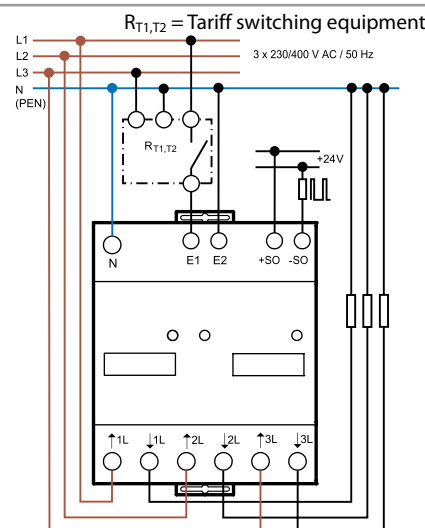
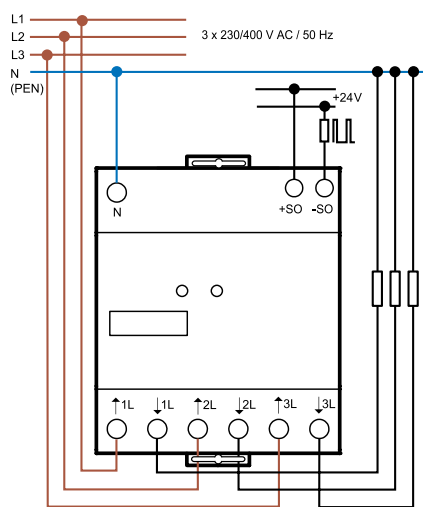

For outline drawing see page 15

Specification

Nominal/Maximum current	A	10/65	10/65
Minimum measured current	A	0.04	0.04
Current range (within accuracy class)	A	0.5...65	0.5...65
Maximum peak current	A	1950 (10 ms)	1950 (10 ms)
Supply (& monitored) voltage (U _N)	V AC	3 x 230	3 x 230
Operating range		(0.8...1.15)U _N	(0.8...1.15)U _N
Frequency	Hz	50	50
Power consumption per phase	W	< 1.5	< 1.5

Display (digit height 4 mm)	Seven digit counter, red decimal digit		
Max. totalising count/Min. increment	kWh	999 999.9/0.1	999 999.9/0.1
LED-Pulses per kWh		100	100

Open collector- output specification (SO+ / SO-)

Voltage (external supply)	V DC	5...30	5...30
Maximum current	mA	20	20
Maximum leakage current @ 30 V/25 °C	µA	10	10
Pulses per kWh		100	100
Pulse length	ms	50	50
Internal series resistance	Ω	100	100
Maximum cable length @ 30 V/20 mA	m	1000	1000

Technical data

Accuracy class		B	B
Ambient temperature	°C	-10...+55	-10...+55
Protective class		II	II
Protection category: Housing/terminals		IP 50/IP 20	IP 50/IP 20

Approvals (according to type)



Single-phase

Single-phase Bi-directional energy meters with backlit LCD display

Type 7E.64.8.230.0001
kWh, kW, V

- Display of active energy consumption (kWh)
- Scroll to view instantaneous voltage (V) and active power (kW)
- 7 digit backlit LCD display
- Class 1 accuracy according to EN 62053-21
- SO output for remote energy monitoring according to EN 62053-31. Active energy (kWh) only

Type 7E.64.8.230.0010
Multifunction MID certified

- Display of total or partial (resettable) energy consumption: kWh, kVAh or kvarh
- Scroll to view the following instantaneous values: V, A, PF, kW, kVA, kvar, Hz and direction of power flow
- 7 digit backlit LCD display
- Active power accuracy Class B according to EN 50470-3
- Programmable* SO pulse output for remote energy monitoring according to EN 62053-31
- Accessories: sealable tamperproof terminal cover
- Protection category II
- 35 mm rail (EN 60715) mount

* SO output can be associated with kWh, kVAh or kvarh.

For outline drawing see page 15

Specification

Reference/Maximum current I_n/I_{max}	A	5/40	5/40
Starting current I_{st}	A	0.02	0.02
Minimum measured current I_{min}	A	0.25	0.25
Current range (within accuracy class)	A	0.5...40	0.5...40
Maximum peak current	A	1200 (10 ms)	1200 (10 ms)
Supply (& monitored) voltage U_N	V AC	230	230
Operating range		$(0.8...1.2)U_N$	$(0.8...1.2)U_N$
Frequency	Hz	50/60	50/60
Power consumption	W/VA	$\leq 0.5/1.5$	$\leq 0.5/1.5$
Display	Seven digit counter - backlit LCD display		
Max. totalising count/Min. increment	kWh	999 999.9/0.1	999 999.9/0.1
LED pulses per kWh		5000	5000
LED pulse length	ms	4 ± 0.5	4 ± 0.5

Output specification (SO+/SO-)

Number/Type		1 opto-isolated output	1 opto-isolated output
Voltage range/Maximum current (conforming to EN 62053-1)	V DC/mA	3.3...27/1...27	3.3...27/1...27
Pulses per kWh*	Imp/kWh*	1000	1000
Pulse length	ms	100 ± 0.5	100 ± 0.5
Maximum cable length	m	1000	1000

Technical data

Accuracy class EN 62053-21 (non MID)/ EN 50470-3 (MID)		1	B
Ambient temperature (Within accuracy class)	°C	-25...+55	-25...+55
Protective class		II	II
Protection category: Housing/terminals		IP 50/IP 20	IP 50/IP 20

Approvals (according to type)



NEW 7E.64.8.230.0001



- Reference current 5 A (40 A Maximum)
- 1-phase 230 V AC
- kWh + instantaneous voltage & kW, V

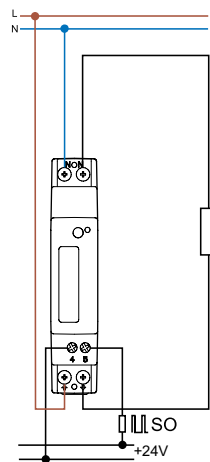

NEW 7E.64.8.230.0010



- Reference current 5 A (40 A Maximum)
- 1-phase 230 V AC
- kWh, kVAh or kvarh + instantaneous V, A, PF, kW, kVA, kvar & Hz
- MID certified

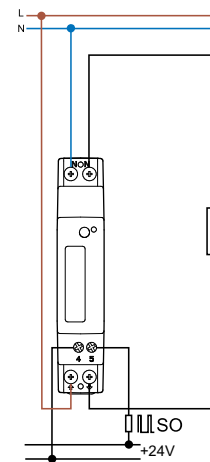

Three-phase

Multifunction Dual tariff energy meters
Bi-directional, MID certified, two SO outputs
with backlit LCD display for 3 or 4 wire systems
Infra-red communications port

Type 7E.78.8.400.0112

Direct connection up to 80 A, dual tariff

Type 7E.86.8.400.0112

6 A direct connection, up to 50 000 A using
current transformer, dual tariff

- Display of total or partial (resettable) energy consumption: kWh, kVAh or kvarh - for both T1 and T2 tariffs - for the total system or per phase
- Scroll to view the following instantaneous values: V, A, PF, kW, kVA, kvar, Hz and direction of power flow
- Fault indication in the event of loss or incorrect phase sequence
- 8 digit backlit LCD display
- Active power accuracy Class B according to EN 50470-3
- Reactive power accuracy Class 2 according to EN 62053-23
- Two programmable** SO pulse outputs for remote energy monitoring according to EN 62053-31
- Infra-red communications port for data exchange with various field protocols, using optional modules
- Protection category II
- Accessories: sealable tamperproof terminal cover
- 35 mm rail (EN 60715) mount

* Minimum CT ratio: 1:1
Maximum CT ratio: 10 000:1
CT full scale programmable: 1 or 5 A

** SO output can be associated with kWh, kVAh or kvarh.

For outline drawing see page 15

Specification

Reference/Maximum current I_n/I_{max}	A	5/80	1/6
Starting current I_{st}	A	0.02	0.002
Minimum measured current I_{min}	A	0.25	0.01
Current range (within accuracy class)	A	0.5...80	0.05...6
Maximum peak current	A	2400 (10 ms)	120 (500 ms)
Supply (& monitored) voltage U_N	V AC	3 x 230/400...3 x 240/415	3 x 230/400...3 x 240/415
Operating range		$(0.8...1.2)U_N$	$(0.8...1.2)U_N$
Frequency	Hz	50/60	50/60
Power consumption per phase	W/VA	$\leq 0.5/7.5$	$\leq 0.5/7.5$
CT burden (per phase)	VA	—	0.04

Display	Eight digit counter - backlit LCD display		
Max. totalising count/Min. increment	kWh	999 999.99/0.01	999 999.99/0.01
LED pulses per kWh		1000	10 000
LED pulse length	ms	10±0.5	10±0.5

Output specification (SO+/SO-)

Number/Type	2 opto-isolated outputs		2 opto-isolated outputs	
Maximum values (conforming to EN 62053-31)	V AC-DC/mA	250/100	250/100	
Pulses per kWh**	Imp/kWh**	100	See table page 13	
Pulse length	ms	50 ± 2	50 ± 2	
Maximum cable length (30 V/20 mA)	m	1000	1000	

Tariff input - opto-isolated

Voltage range	V AC/DC	80...275	80...275
---------------	---------	----------	----------

Technical data

Accuracy class EN 50470-3 (MID)		B	B
Ambient temperature	°C	-25...+55 °C	-25...+55 °C
Protective class		II	II
Protection category: Housing/terminals		IP 50/IP 20	IP 50/IP 20

Approvals (according to type)



NEW 7E.78.8.400.0112



- Reference current 5 A (80 A Maximum)
- Three-phase systems - 3 or 4 wire
- Dual tariff
- MID certified

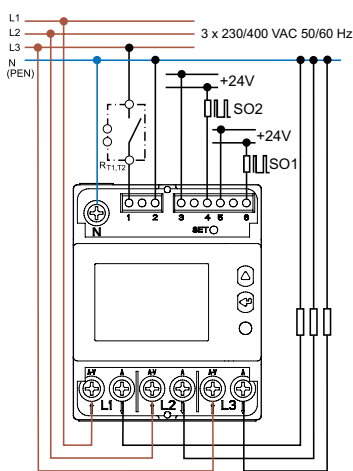

R_{T1,T2} = Tariff switching equipment

NEW 7E.86.8.400.0112



- Reference current 1 A (6 A Maximum)
- Three-phase systems - 3 or 4 wire
- Usable with current CT transformer*
- Programmable CT secondary*
- Dual tariff
- MID certified

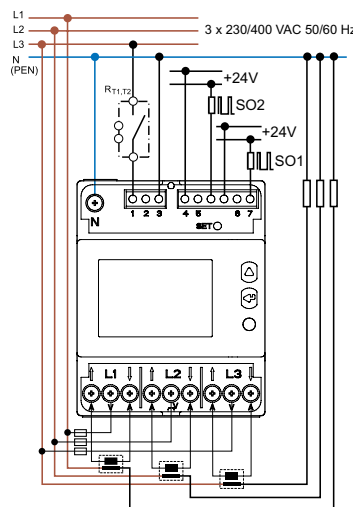

R_{T1,T2} = Tariff switching equipment

Single-phase

**Multifunction, Bi-directional energy meter
MID certified with RS485 Modbus integrated
interface and backlit LCD display**

- Display of total or partial (resettable) energy consumption: kWh, kVAh or kvarh
- Scroll to view the following instantaneous values: V, A, PF, kW, kVA, kvar, Hz and direction of power flow
- 7 digit backlit LCD display
- Active power accuracy Class B according to EN 50470-3
- RS485 Modbus integrated communications port
- Programmable** SO pulse output for remote energy monitoring according to EN 62053-31
- Accessories: sealable tamperproof terminal cover
- Protection category II
- 35 mm rail (EN 60715) mount

* Default transmission baud rate: 19 200 bps
** SO output can be associated with kWh, kVAh or kvarh.

NEW 7E.64.8.230.0210



- Reference current 5 A (40 A Maximum)
- RS485 Modbus integrated interface
- 1-phase 230 V 50/60 Hz
- MID certified

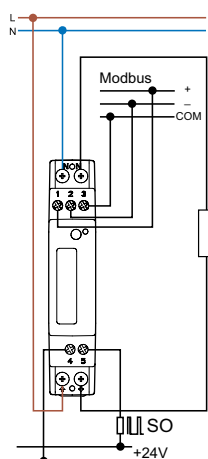

For outline drawing see page 16

Specification

Reference/Maximum current I_N/I_{max}	A	5/40
Starting current I_{st}	A	0.02
Minimum measured current I_{min}	A	0.25
Current range (within accuracy class)	A	0.5...40
Maximum peak current	A	1200 (10 ms)
Supply (& monitored) voltage U_N	V AC	230
Operating range		$(0.8...1.2)U_N$
Frequency	Hz	50/60
Power consumption	W/VA	$\leq 0.5/1.5$
Display		Seven digit counter - backlit LCD display
Max. totalising count/Min. increment	kWh	999 999.9/0.1
LED pulses per kWh		5000
LED pulse length	ms	4 ± 0.5

Modbus technical data

Bus System		RS485 Modbus
Conforms to standard		EIA RS485
Max. bus length	m	1000
Max. Modbus energy meters connectable		32
Baud rate*	Baud	2400, 4800, 9600, 19 200, 38 400

Output specification (SO+/SO-)

Number/Type		1 opto-isolated output
Voltage range/Maximum current (conforming to EN 62053-31)	V DC/mA	$3.3...27/1...27$
Pulses per kWh**	Imp/kWh**	1000
Pulse length	ms	100 ± 2

Technical data

Accuracy class		B
Ambient temperature (Within accuracy class)	°C	$-25...+55$
Protective class		II
Protection category: Housing/terminals		IP 50/IP 20

Approvals (according to type)



Three-phase

Multifunction Dual tariff energy meters
Bi-directional, MID certified with RS485
Modbus integrated interface, single SO output
and backlit LCD display for 4 wire systems

Type 7E.78.8.400.0212

Direct connection up to 80 A, dual tariff

Type 7E.86.8.400.0212

6 A direct connection, up to 50 000 A using
current transformer, dual tariff

- Display of total or partial (resettable) energy consumption: kWh, kVAh or kvarh - for both T1 and T2 tariffs - for the total system or per phase
- Scroll to view the following instantaneous values: V, A, PF, kW, kVA, kvar, Hz and direction of power flow
- Fault indication in the event of loss or incorrect phase sequence
- 8 digit backlit LCD display
- RS485 Modbus integrated communications port
- Programmable*** SO pulse output for remote energy monitoring according to EN 62053-31
- Active power accuracy Class B according to EN 50470-3
- Reactive power accuracy Class 2 according to EN 62053-23
- Protection category II
- Accessories: sealable tamperproof terminal cover
- 35 mm rail (EN 60715) mount

* Minimum CT ratio: 1:1

Maximum CT ratio: 10 000:1

CT secondary programmable: 1 or 5 A

** Default transmission baud rate: 19 200 bps

*** SO output can be associated with kWh, kVAh or kvarh.

For outline drawing see page 16

Specification

Reference/Maximum current I_n/I_{max}	A	5/80	1/6
Starting current I_{st}	A	0.02	0.002
Minimum measured current I_{min}	A	0.25	0.01
Current range (within accuracy class)	A	0.5...80	0.05...6
Maximum peak current	A	2400 (10 ms)	120 (500 ms)
Supply (& monitored) voltage U_N	V AC	3 x 230/400...3 x 240/415	3 x 230/400...3 x 240/415
Operating range		$(0.8...1.2)U_N$	$(0.8...1.2)U_N$
Frequency	Hz	50/60	50/60
Power consumption per phase	W/VA	$\leq 1/3.5$	$\leq 1/3.5$
CT burden (per phase)	VA	—	0.04

Display Eight digit counter - backlit LCD display

Max. totalising count/Min. increment	kWh	999 999.99/0.01	999 999.99/0.01
LED pulses per kWh		1000	10 000
LED pulse length	ms	10±0.5	10±0.5

Modbus technical data

Bus system		RS485 Modbus	RS485 Modbus
Conforms to standard		EIA RS485	EIA RS485
Max. bus length	m	1000	1000
Max. Modbus energy meters connectable		32	32
Baud rate**	Baud	300...57 600	300...57 600

Output specification (SO+/SO-)

Number/Type		1 opto-isolated output	1 opto-isolated output
Voltage range/Maximum current (conforming to EN 62053-31)	V DC/mA	3.3...27/1...27	3.3...27/1...27
Pulse per kWh***	Imp/kWh***	100	See table page 13
Pulse length	ms	50 ± 2	50 ± 2

Tariff input - opto-isolated

Voltage range	V AC/DC	80...275	80...275
---------------	---------	----------	----------

Technical data

Accuracy class		B	B
Ambient temperature (Within accuracy class)	°C	-25...+55	-25...+55
Protective class		II	II
Protection category: Housing/terminals		IP 50/IP 20	IP 50/IP 20

Approvals (according to type)

**NEW 7E.78.8.400.0212**

- Reference current 5 A (80 A Maximum)
- RS485 Modbus integrated interface
- Three-phase systems - 4 wire
- Dual tariff
- MID certified

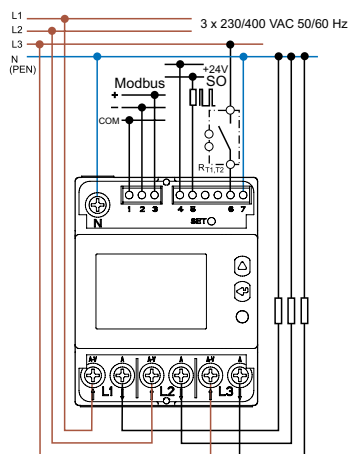

R_{T1,T2} = Tariff switching equipment

NEW 7E.86.8.400.0212

- Reference current 1 A (6 A Maximum)
- RS485 Modbus integrated interface
- Three-phase systems - 4 wire
- Usable with current transformer*
- Programmable CT secondary*
- Dual tariff
- MID certified

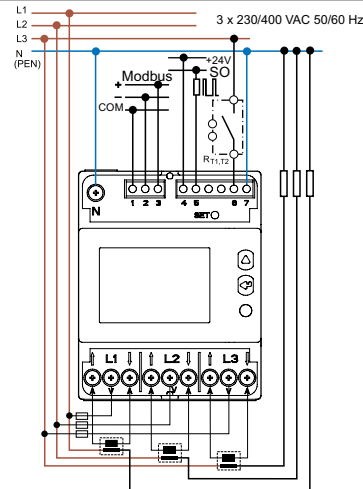

R_{T1,T2} = Tariff switching equipment

Single-phase

**Multifunction energy meter
Bi-directional, MID certified with M-Bus
integrated interface and backlit LCD display**

- Display of total or partial (resettable) energy consumption: kWh, kVAh or kvarh
- Scroll to view the following instantaneous values: V, A, PF, kW, kVA, kvar, Hz and direction of power flow
- 7 digit backlit LCD display
- Active power accuracy Class B according to EN 50470-3
- M-Bus integrated communications port
- Programmable** SO pulse output for remote energy monitoring according to EN 62053-31
- Accessories: sealable tamperproof terminal cover
- Protection category II
- 35 mm rail (EN 60715) mount

* Default transmission baud rate: 2400 bps
** SO output can be associated with kWh, kVAh or kvarh.

NEW 7E.64.8.230.0310



- Reference current 5 A (40 A Maximum)
- M-Bus integrated interface
- 1-phase 230 V 50/60 Hz
- MID certified

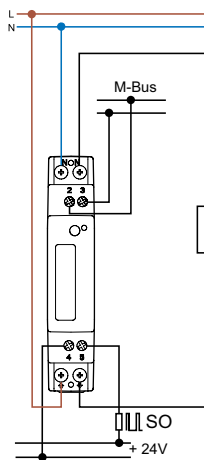

For outline drawing see page 16

Specification

Reference/Maximum current I_n/I_{max}	A	5/40
Starting current I_{st}	A	0.02
Minimum measured current I_{min}	A	0.25
Current range (within accuracy class)	A	0.5...40
Maximum peak current	A	1200 (10 ms)
Supply (& monitored) voltage U_N	V AC	230
Operating range		$(0.8...1.2)U_N$
Frequency	Hz	50/60
Power consumption per phase	W/VA	$\leq 0.5/1.5$
Display		Seven digit counter - backlit LCD display
Max. totalising count/Min. increment	kWh	999 999.9/0.1
LED pulses per kWh		5000
LED pulse length	ms	4 ± 0.5

M-bus technical data

Bus System		M-Bus
Conforms to standard		EN 13757-1-2-3
Baud rate*	Baud	300, 2400, 9600

Output specification (SO+/SO-)

Number/Type		1 opto-isolated output
Voltage range/Maximum current (conforming to EN 62053-31)	V DC/mA	3.3...27/1...27
Pulses per kWh**	Imp/kWh**	1000
Pulse length	ms	100 ± 0.5

Technical data

Accuracy class		B
Ambient temperature (Within accuracy class)	°C	-25...+55
Protective class		II
Protection category: Housing/terminals		IP 50/IP 20

Approvals (according to type)



Three-phase

Multifunction Dual tariff energy meters
Bi-directional, MID certified with M-Bus
integrated interface, single SO output and
backlit LCD display for 3 or 4 wire systems

Type 7E.78.8.400.0312

Direct connection up to 80 A, dual tariff

Type 7E.86.8.400.0312

6 A direct connection, up to 50 000 A using
current transformer, dual tariff

- Display of total or partial (resettable) energy consumption: kWh, kVAh or kvarh - for both T1 and T2 tariffs - for the total system or per phase
- Scroll to view the following instantaneous values: V, A, PF, kW, kVA, kvar, Hz and direction of power flow
- Fault indication in the event of loss or incorrect phase sequence
- 8 digit backlit LCD display
- M-Bus integrated communications port
- Programmable** SO pulse output for remote energy monitoring according to EN 62053-31
- Active power accuracy Class B according to EN 50470-3
- Reactive power accuracy Class 2 according to EN 62053-23
- Protection category II
- Accessories: sealable tamperproof terminal cover
- 35 mm rail (EN 60715) mount

- * Minimum CT ratio: 1:1
Maximum CT ratio: 10 000:1
CT secondary programmable: 1 or 5 A
- ** Default transmission baud rate: 2400 bps
- *** SO output can be associate with kWh, kVAh or kvarh.

For outline drawing see page 16

Specification

Reference/Maximum current I_n/I_{max}	A	5/80	1/6
Starting current I_{st}	A	0.02	0.002
Minimum measured current I_{min}	A	0.25	0.01
Current range (within accuracy class)	A	0.5...80	0.05...6
Maximum peak current	A	2400 (10 ms)	120 (500 ms)
Supply (& monitored) voltage U_N	V AC	3 x 230/400...3 x 240/415	3 x 230/400...3 x 240/415
Operating range		$(0.8...1.2)U_N$	$(0.8...1.2)U_N$
Frequency	Hz	50/60	50/60
Power consumption per phase	W/VA	$\leq 0.5/7.5$	$\leq 0.5/7.5$
CT burden (per phase)	VA	—	0.04
Display		Eight digit counter - backlit LCD display	
Max. totalising count/Min. increment	kWh	999 999.99/0.01	999 999.99/0.01
LED pulses per kWh		1000	10 000
LED pulse length	ms	10±0.5	10±0.5
M-bus technical data			
Bus system		M-Bus	M-Bus
Conforms to standard		EN 13757-1-2-3	EN 13757-1-2-3
Baud rate**	Baud	300...9600	300...9600
Output specification (SO+/SO-)			
Number/Type		1 opto-isolated output	1 opto-isolated output
Voltage range/Maximum current (conforming to EN 62053-31)	V DC/mA	3.3...27/1...27	3.3...27/1...27
Pulses per kWh***	Imp/kWh***	100	See table page 13
Pulse length	ms	50 ± 2	50 ± 2
Tariff input - opto-isolated			
Voltage range	V AC/DC	80...275	80...275
Technical data			
Accuracy class		B	B
Ambient temperature (Within accuracy class)	°C	-25...+55	-25...+55
Protective class		II	II
Protection category: Housing/terminals		IP 50/IP 20	IP 50/IP 20

Approvals (according to type)

**NEW 7E.78.8.400.0312**

- Reference current 5 A (80 A Maximum)
- M-Bus integrated interface
- Three-phase systems programmable 3 or 4 wire
- Dual tariff
- MID certified

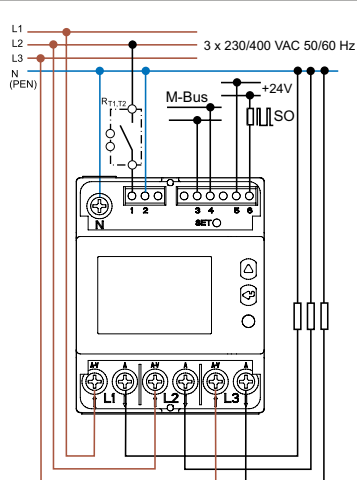

R_{T1,T2} = Tariff switching equipment

NEW 7E.86.8.400.0312

- Reference current 1 A (6 A Maximum)
- M-Bus integrated interface
- Three-phase systems programmable 3 or 4 wire
- Usable with current transformer*
- Programmable CT secondary*
- Dual tariff
- MID certified

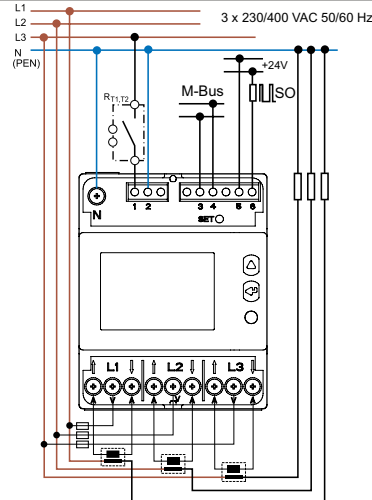

R_{T1,T2} = Tariff switching equipment

Three-phase

**Multifunction energy meter
Bi-directional, MID certified with Ethernet
Modbus TCP integrated interface and backlit
LCD display for 4 wire systems**

**Type 7E.78.8.400.0410:
Direct connection up to 80 A**

**Type 7E.86.8.400.0410:
6 A direct installation, up to 50 000 A using
current transformer**

- Display of total or partial (resettable) energy consumption: kWh, kVAh or kvarh - for the total system or per phase
- Scroll to view the following instantaneous values: V, A, PF, kW, kVA, kvar, Hz and direction of power flow
- Fault indication in the event of loss or incorrect phase sequence
- 8 digit backlit LCD display
- Ethernet Modbus TCP integrated communications port
- Programmable** SO pulse output for remote energy monitoring according to EN 62053-31
- Active power accuracy Class B according to EN 50470-3
- Reactive power accuracy Class 2 according to EN 62053-23
- Protection category II
- Accessories: sealable terminal cover tamper
- 35 mm rail (EN 60715) mount

- * Minimum CT ratio: 1:1
Maximum CT ratio: 10 000:1
CT secondary programmable: 1 or 5 A
- ** SO output can be associate with kWh, kVAh or kvarh.

For outline drawing see page 16

Specification

Reference/Maximum current I_n/I_{max}	A	5/80	1/6
Starting current I_{st}	A	0.02	0.002
Minimum measured current I_{min}	A	0.25	0.01
Current range (within accuracy class)	A	0.5...80	0.05...6
Maximum peak current	A	2400 (10 ms)	120 (500 ms)
Supply (& monitored) voltage U_N	V AC	3 x 230/400...3 x 240/415	3 x 230/400...3 x 240/415
Operating range		$(0.8...1.2)U_N$	$(0.8...1.2)U_N$
Frequency	Hz	50/60	50/60
Power consumption per phase	W/VA	$\leq 1/3.5$	$\leq 1/3.5$
CT burden (per phase)	VA	—	0.04
Display		Eight digit counter - backlit LCD display	
Max. totalising count/Min. increment	kWh	999 999.99/0.01	999 999.99/0.01
LED pulses per kWh		1000	10 000
LED pulse length	ms	10±0.5	10±0.5
Ethernet technical data			
Bus system		Ethernet TCP	Ethernet TCP
Protocol		Modbus TCP, HTTP, NTP; DHCP	Modbus TCP, HTTP, NTP; DHCP
Conforms to standard		IEEE 802.3	IEEE 802.3
Communication speed	Mbps	10/100	10/100
Open collector- output specification (SO+/SO-)			
Number/Type		1 opto-isolated output	1 opto-isolated output
Voltage range/Maximum current (conform to EN 62053-31)	V DC/mA	3.3...27/1...27	3.3...27/1...27
Pulses per kWh**	Imp/kWh**	100	See table page 13
Pulse length	ms	50 ± 2	50 ± 2
Technical data			
Accuracy class		B	B
Ambient temperature (Within accuracy class)	°C	-25...+55	-25...+55
Protective class		II	II
Protection category: Housing/terminals		IP 50/IP 20	IP 50/IP 20
Approvals (according to type)			

NEW 7E.78.8.400.0410



- Reference current 5 A (80 A Maximum)
- Ethernet Modbus TCP integrated interface
- Three-phase systems - 4 wire

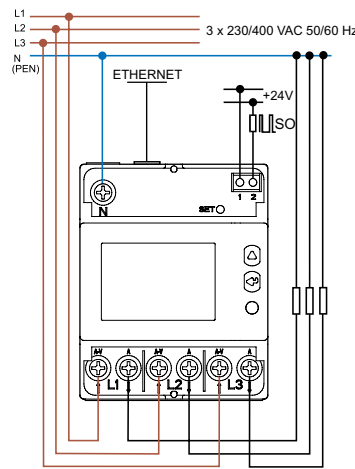

NEW 7E.86.8.400.0410



- Reference current 1 A (6 A Maximum)
- Ethernet Modbus TCP integrated interface
- Three-phase systems - 4 wire
- Usable with current transformer*
- Full scale (FSA) programmable*

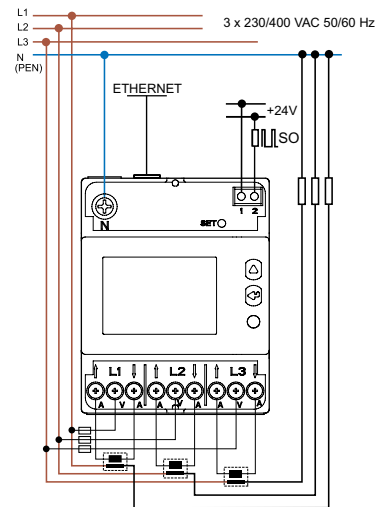

Ordering information

Example: Energy meter 32 A/230 V AC, with PTB certified, with MID certification, Class B accuracy, for 35mm rail (EN 60715) mounting. Available with Tamper-proof lead sealed cover as accessory.

7 E . 1 3 . 8 . 2 3 0 . 0 0 1 0

Series

Function

1 = 1-phase

3 = 3-phase

Current

2 = 25 A

3 = 32 A

6 = 65 A

Supply version

8 = AC 50 Hz

Option

0 = SO +/- pulse output

Special version

0 = Standard

1 = MID compliant versions

Option

0 = Standard

2 = Standard (7E.12)

2 = Dual tariff (7E.36)

Supply voltage

230 = 230 V AC 50 Hz

400 = 3 x 230/400 V AC 50 Hz

All versions/width

7E.12.8.230.0002/35 mm



7E.13.8.230.0010/17.5 mm

7E.16.8.230.0010/35 mm

7E.36.8.400.0010/70 mm

7E.36.8.400.0012/70 mm

E Technical data

Insulation EN 62053-21		7E.12, 7E.13, 7E.16		7E.36		
Insulation rated voltage	V	250		250		
Overvoltage category		IV		IV		
Insulation	between active parts and SO+/SO- terminals	kV (1.2/50 µs)	6	6		
	between adjacent phases	kV (1.2/50 µs)	—	6		
Insulation	between supply and SO+/SO-	V AC	4000	4000		
	between adjacent phases	V AC	—	4000		
Protection class		II		II		
EMC Specification		Reference standard				
Electrostatic discharge	contact discharge		EN 61000-4-2	8 kV		
	air discharge		EN 61000-4-2	15 kV		
Radio-Frequency Electromagnetic Field (80...1000)MHz			EN 61000-4-3	10 V/m		
Fast Transients (Burst) (5-50 ns, 5 kHz)	on Supply terminals		EN 61000-4-4	Class 4 (4 kV)		
	on SO+/SO- terminals		EN 61000-4-4	Class 4 (2 kV)		
Surge (1.2/50 µs)	on Supply terminals		EN 61000-4-5	Class 4 (4 kV)		
	on SO+/SO- terminals		EN 61000-4-5	Class 3 (1 kV)		
Radio-Frequency Common Mode (0.15...80)MHz on Supply terminals			EN 61000-4-6	10 V		
Radiated and Conducted Emission			EN 55022	Class B		
Other data						
Pollution degree		2				
Vibration resistance	(10...60)Hz	mm	0.075			
	(60...150)Hz	g	1			
Vibration resistance of the internal mechanical counter (10...500)Hz	g	2				
Shock resistance	g/18 ms	30				
Shock resistance of the internal mechanical counter	g/18 ms	350				
Power lost to the environment			7E.12, 7E.13	7E.16	7E.36	
	without current	W	0.4	0.4	1.5	
	with maximum current	W	1	2	6	
Supply terminals	Max. wire size		7E.12, 7E.13		7E.16, 7E.36	
			solid cable	stranded cable	solid cable	stranded cable
		mm ²	1...6	0.75...4	1.5...16	1.5...16
	AWG	18...10	18...12	16...6	16...6	
	 Screw torque for I _{max}	Nm	0.8...1.2		1.5...2	
Screw		Pozidriv No.1, Flat No.1, 2				
SO+/SO- terminals	Max. wire size		solid cable	stranded cable	solid cable	stranded cable
		mm ²	2.5	1.5	2.5	1.5
		AWG	14	16	14	16
	 Screw torque for I _{max}	Nm	0.5		0.8	
	Screw		Pozidriv No.0, Flat No.1		Pozidriv No.0, Flat No.2	

Ordering information - Energy meter

Example: 3-phase energy meter for current transformer operation (6A/400 V AC), with MID certification, Class B accuracy, for 35 mm rail (EN 60715) mounting. Supplied accessories: Tamper-proof lead sealed cover as accessory.

7	E	.	8	.	6	.	8	.	4	0	0	.	0	1	1	2
Series			Function			Special version			Option			Special version				
6 = 1-phase, backlit display			7 = 3-phase, backlit display, direct connection			0 = Standard			0 = SO pulse output			0 = Single tariff				
8 = 3-phase, backlit display, for current transformer operation						1 = Infra-red comms. port + two SO pulse outputs			2 = RS485 Modbus integrated interface + SO pulse output			1 = kWh only (0001)				
						2 = M-Bus integrated interface + SO pulse output			3 = Ethernet integrated interface plus SO pulse output			2 = Dual tariff				
												3 = Panel mounting				
Current			Supply version			Supply voltage						Version				
4 = 40 A			8 = AC 50/60 Hz			230 = 230 V AC 50/60 Hz						0 = Standard				
6 = 6 A (up to 50 000 A, using 7E.86 and CT)						400 = 3 x 230/415 V AC 50/60 Hz						1 = Conforms to MID directive				
8 = 80 A																

Table 1

Imp/kWh*	CT ratio
1000	1...4
200	5...24
40	25...124
8	125...624
1	625...3124
0.1	3125...10 000

*Imp/kWh, Imp/kvarh, Imp/kVAh

Available versions

Infra-red comms. port for use with communication modules

7E.78.8.400.0112	Modbus	7E.64.8.230.0210	M-Bus	7E.64.8.230.0310	Ethernet	7E.78.8.400.0410	SO only	7E.64.8.230.0001
7E.86.8.400.0112		7E.78.8.400.0212		7E.78.8.400.0312		7E.86.8.400.0410		7E.64.8.230.0010
		7E.86.8.400.0212		7E.86.8.400.0312				

Technical data

Insulation			7E.64.8.230.0xxx	7E.78.8.400.0xxx	7E.86.8.400.0xxx	
Insulation rated voltage			V	250	250	250
Insulation	between active parts and SO+/SO- terminals	kV (1.2/50 μs)	6			
	between supply and Modbus, M-Bus terminal	kV (1.2/50 μs)	6			
	between adjacent phases	kV(1.2/50 μs)	n/a			
Insulation	between active parts and SO+/SO- terminals	V AC	4000			
	between supply and Modbus, M-Bus terminal	V AC	4000			
	between adjacent phases	V AC	n/a			
Protection class			II			
EMC Specification according to 61000-4-(2/3/4)			7E.64.8.230.0xxx	7E.78.8.400.0xxx	7E.86.8.400.0xxx	
Electrostatic discharge	contact discharge		8 kV			
	air discharge		15 kV			
Radio frequency Electromagnetic field (80...2000)MHz			30 V/m			
Fast Transients (burst) (5-50 ns, 5 kHz)	on Supply terminals		4 kV			
	on SO+/SO- terminals		2 kV			
	Modbus, M-Bus terminal		2 kV			
Surge (1.2/50 μs)	on Supply terminals		4 kV			
	on SO+/SO- terminals		1 kV			
	Modbus, M-Bus terminal		1 kV			
Other data			7E.64.8.230.0xxx	7E.78.8.400.0xxx	7E.86.8.400.0xxx	
Pollution degree			2			
Vibration resistance			EN 60068-2-6	EN 60068-2-6	EN 60068-2-6	
Shock resistance			EN 60068-2-27	EN 60068-2-27	EN 60068-2-27	
Power lost to the environment	Max value per phase		0.5W/1.5 VA	1W/7.5VA	1W/7.5VA	
	CT burden		—	—	0.04 VA/per phase	
Supply terminals			7E.64.8.230.0xxx	7E.78.8.400.0xxx	7E.86.8.400.0xxx	
Max. wire size	mm ²	solid cable	max 6	max 35	max 6	
		stranded cable	1.5...6	1.5...35	1.5...6	
	AWG	—	—	—	—	
Screw torque for I _{max}			Nm	1.5	2	1.5
SO+/SO- terminals, RS485 Modbus, M-Bus			7E.64.8.230.0xxx	7E.78.8.400.0xxx	7E.86.8.400.0xxx	
Max. wire size	mm ²	solid cable	max 2.5	max 2.5	max 2.5	
		stranded cable	0.14...2.5	0.14...2.5	0.14...2.5	
	AWG	—	—	—	—	
Screw torque			Nm	0.5	0.5	0.5

Mechanical Display Type 7E.12, 7E.13, 7E.16, 7E.36

LED indication (Normal operation)

Type	Energy consumption			Pulses per kWh	Pulse space	The LED Pulse rate represents the instantaneous power being consumed, according to the following
	None	Low	High			
7E.12 7E.13				2000	100 ms	$kW = (\text{number of pulse per Minute}) / 33.3$
7E.16				1000	100 ms	$kW = (\text{number of pulse per Minute}) / 16.7$
7E.36				100	150 ms	$kW = (\text{number of pulse per Minute}) / 1.7$

LED indication (Abnormal operation)

Status indicates errors of installation, as below

Type 7E.12, 7E.13, 7E.16

Device ON, incorrect connection (L-N inverted).

Mark = 600 ms, Space = 600 ms



Type 7E.36

Mark = 100 ms,

Phase L1 ↑ L1 ↓ inverted or loss

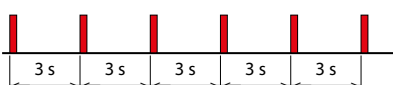

Phase L1 ↑ L1 ↓ and L2 ↑ L2 ↓ inverted or loss

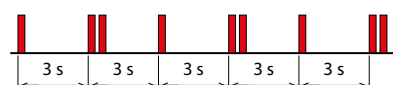

Phase L2 ↑ L2 ↓ inverted or loss

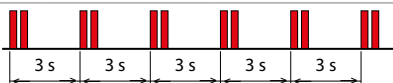

Phase L1 ↑ L1 ↓ and L3 ↑ L3 ↓ inverted or loss

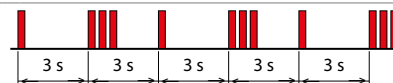

Phase L3 ↑ L3 ↓ inverted or loss

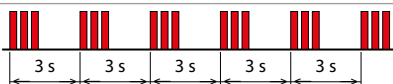

Phase L2 ↑ L2 ↓ and L3 ↑ L3 ↓ inverted or loss

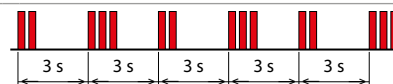

Phase L1 ↑ L1 ↓ and L2 ↑ L2 ↓ and L3 ↑ L3 ↓ inverted or loss

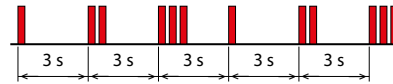

SO+/SO- Open collector output wiring diagram Type 7E.12, 7E.13, 7E.16, 7E.36

The pulsating open collector output available at terminals SO+ and SO- can be interfaced with the input of a computer, plc or other energy management equipment to allow the remote monitoring of energy consumed.

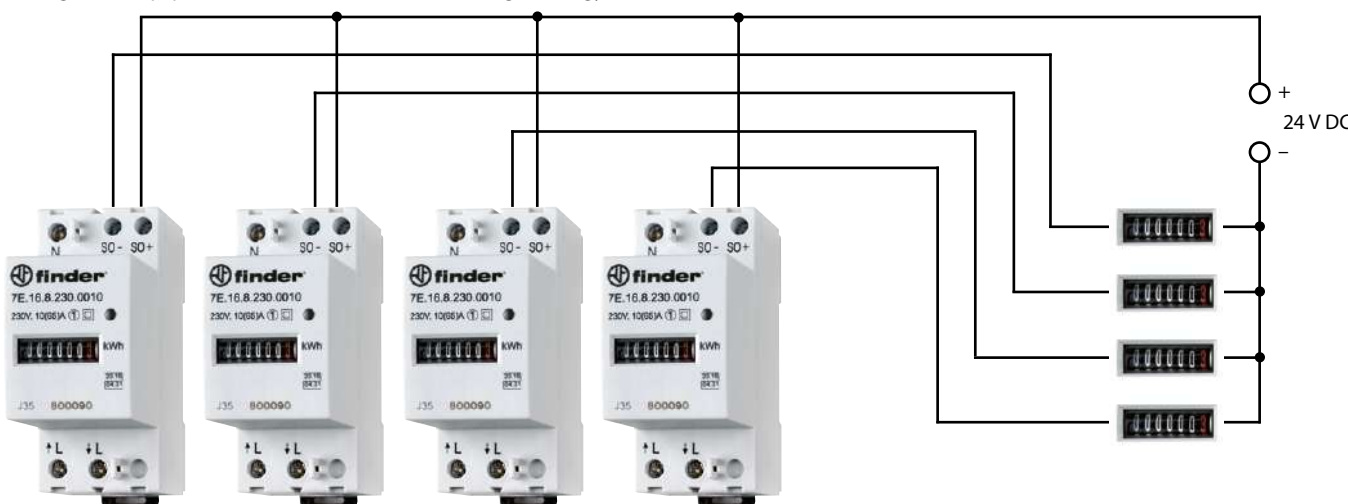

Energy meters – at difference locations
(Note: Both Single and Dual tariff meters provide only a single pulsating output)

Central monitoring/management system
(max. 20 mA for each input)

SO-Output Type 7E.12, 7E.13, 7E.16

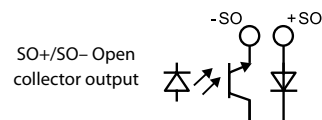

SO+/SO- Open collector output

SO-Output Type 7E.36

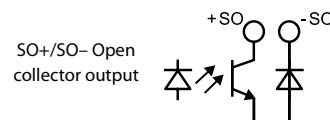

SO+/SO- Open collector output

Outline drawing

Type 7E.12.8.230.0002/7E.16.8.230.0010

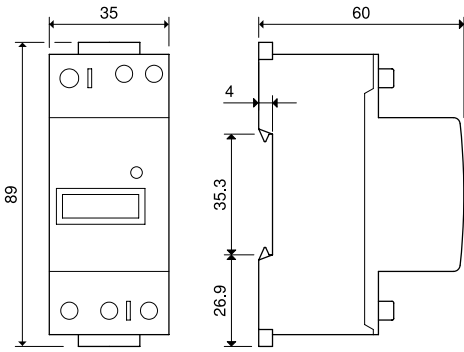

Type 7E.13.8.230.0010

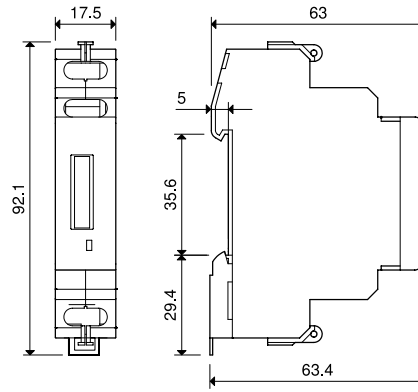

Type 7E.36.8.400.0010

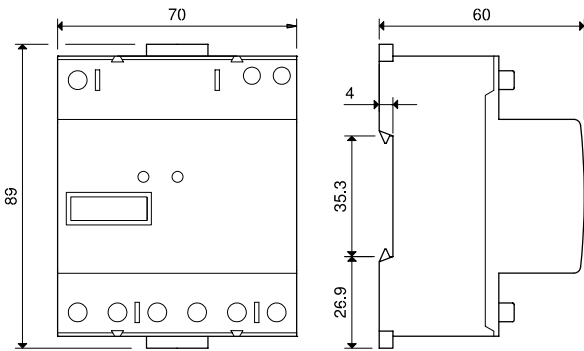

Type 7E.36.8.400.0012

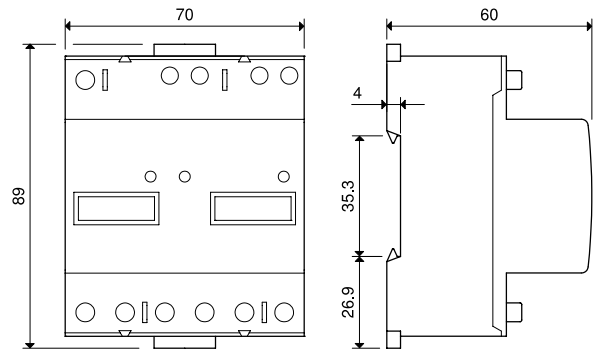

Type 7E.64.8.230.0001

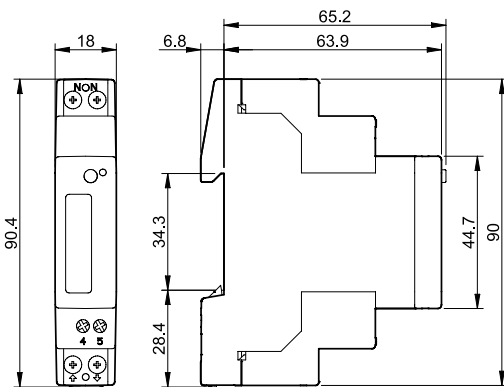

Type 7E.64.8.230.0010

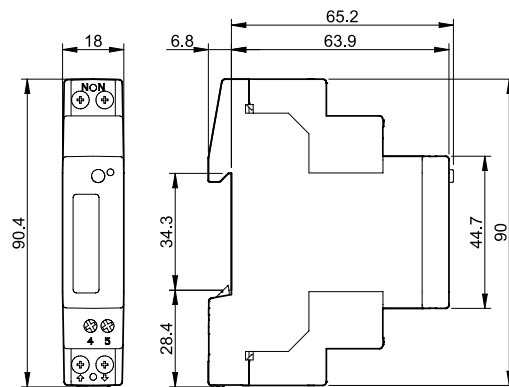

Type 7E.78.8.400.0112

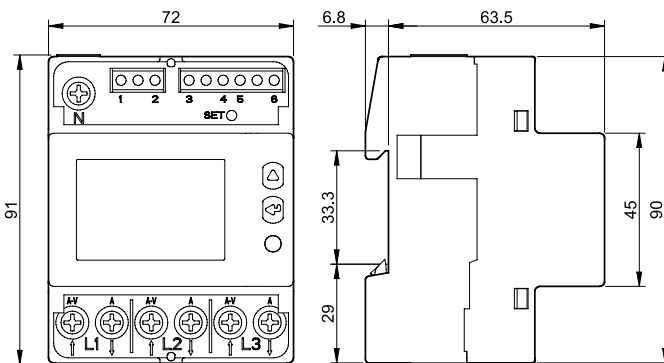

Type 7E.86.8.400.0112

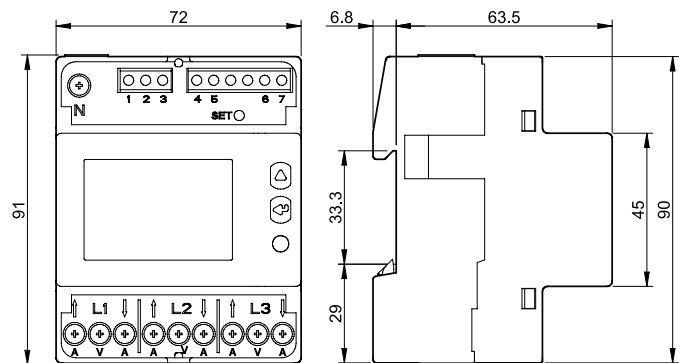

Outline drawing

Type 7E.64.8.230.0210

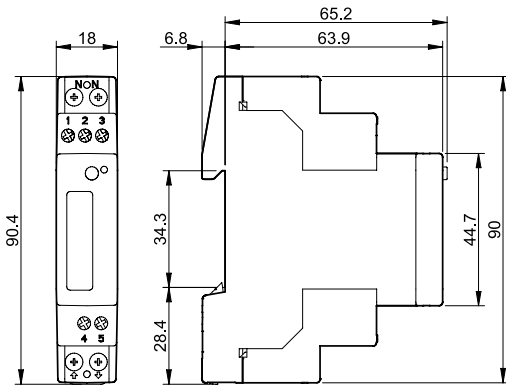

Type 7E.64.8.230.0310

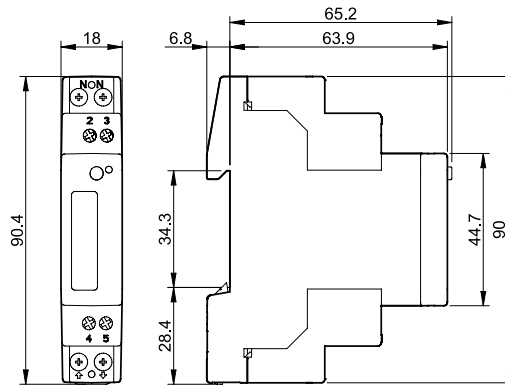

Type 7E.78.8.400.0212

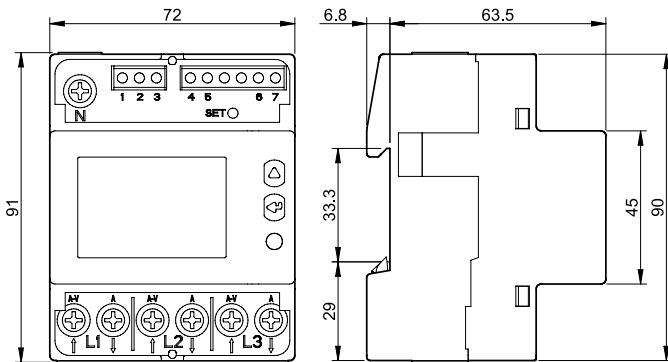

Type 7E.86.8.400.0212

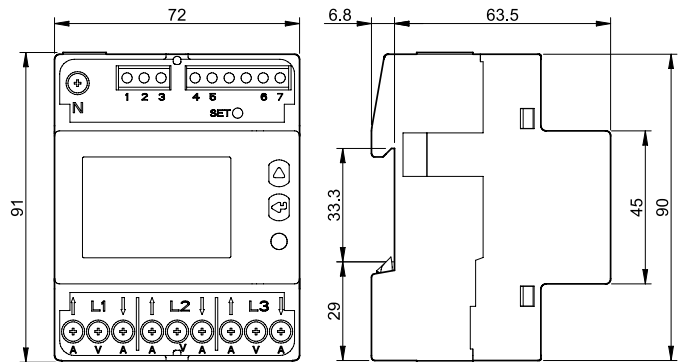

Type 7E.78.8.400.0312

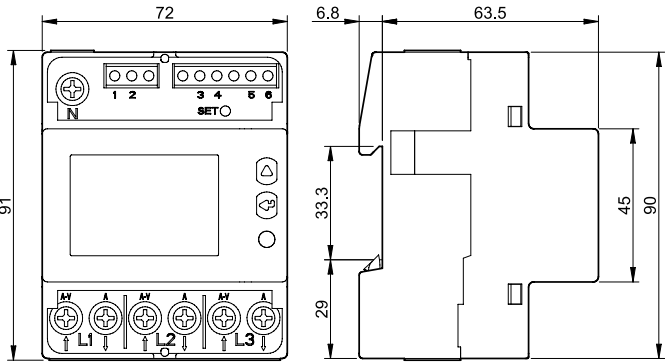

Type 7E.86.8.400.0312

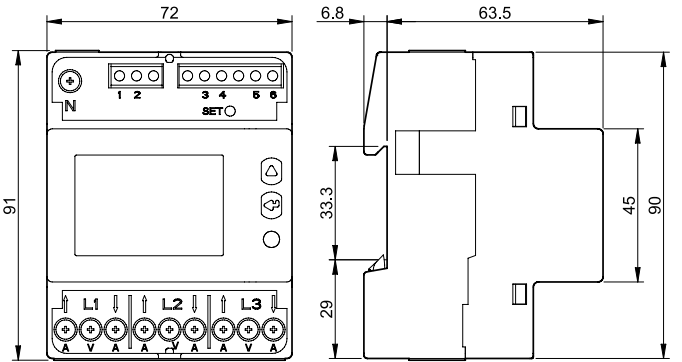

Type 7E.78.8.400.0410

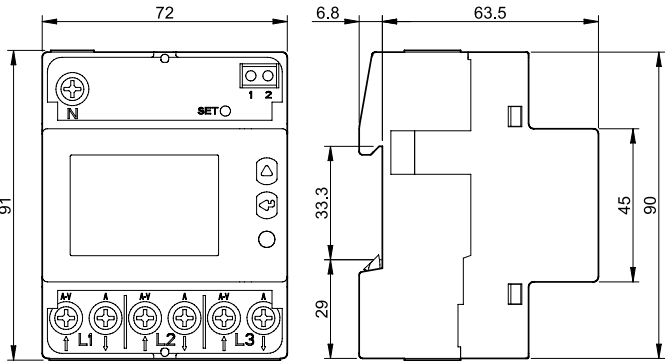

Type 7E.86.8.400.0410

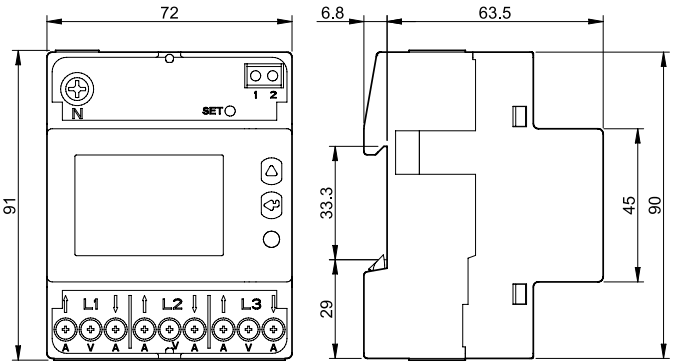

E

Accessories



07E.13

Terminal cover for type 7E.13

07E.13

For the tamper-proof lead seal use two terminal covers



07E.16

Terminal cover for type 7E.12, 7E.16 and 7E.36

07E.16

7E.12, 7E.16 - For the tamper-proof lead seal use two terminal covers

7E.36 - For the tamper-proof lead seal use four terminal covers

Terms and definitions

I	The electrical current flowing through the meter
I_n	The specified reference current for which the meter has been designed
I_{st}	The lowest declared value of " I " at which the meter registers active electrical energy at unity power factor (polyphase meters with balanced load)
I_{min}	The values of " I " above which the error lies within maximum permissible errors (MPEs) (polyphase meters with balanced load)
I_{tr}	The value of " I " above which the error lies within the smallest MPE corresponding to the class index of the meter
I_{max}	The maximum value of " I " for which the error lies within the MPEs

E

Detailed structure of the protocol is available on line

SPD Type 1+2 Surge arrester range high discharge capability with no following current - single/three phase systems

- Surge arresters, suitable for low-voltage applications, to protect equipment against overvoltage by direct lightning strike, induced overvoltage and switching overvoltage
- To be installed at the boundary of LPZ 0 - LPZ 1 zones or higher
- Versions with combination of varistor and high-performance spark gap (GDT) ensures:
 - high discharge current
 - high insulation resistance that eliminates leakage current
 - no following current
- Very low residual voltage
- Replaceable modules
- Upside down mounting possible (thanks to dual terminal markings and new restraint system for the replaceable module that permits its inversion)
- Visual fault signalling: Healty/Replace
- Double screw terminal
- Remote status signalling contact: Healty/Replace/Presence. Connector 07P01 included
- According to EN 61 643-11
- 35 mm rail EN 60715 mounting, 36 mm each pole

7P.09.1.255.0100 SPD Type 1, GDT protection for N-PE application only, for 3+1 configuration

7P.01.8.260.1025 SPD Type 1+2, varistor + GDT unipolar protection suitable to realize single phase or three phase systems (230/400V) with the GDT protection module (7P09)

7P.02.8.260.1025 SPD Type 1+2 for single phase TT and TN-S system. Varistor + GDT protection L-N + GDT protection N-PE

For outline drawing see page 15

SPD specification

	N-PE	7P.01.8.260.1025	L-N	N-PE
Nominal voltage (U _N)	—	230	230	—
Maximum operating voltage (U _C)	255	260	260	255
Lightning impulse current (10/350 μs) (I _{imp})	100	25	25	50
Nominal discharge current (8/20 μs) (I _n)	100	30	30	50
Maximum discharge current (8/20 μs) (I _{max})	100	60	60	100
Voltage protection level (U _p)	1.5	1.5	1.5	1.5
Ability to independently switch off the following current (I _f)	100	No following current	No following current	100
I _{pE}	< 4	< 4	< 4	< 4
TOV 120 min L-N	—	440	440	—
TOV 5 s L-N	—	335	335	—
TOV 200 ms N-PE	1200	—	—	1200
Response time (t _a)	100	100	100	100
Short-circuit proof at maximum overcurrent protection - I _{SSCR}	—	50	50	—
Maximum overcurrent protection (fuse rating gL/gG)	—	250 A	250 A	—
Maximum overcurrent protection for serial connection	—	125 A gL/gG	125 A gL/gG	—
Replacement module code	7P.00.1.000.0100	7P.00.8.260.0025	7P.00.8.260.0025	7P.00.1.000.0050

Other technical data

Ambient temperature range	-40...+80			
Protection degree	IP20			
Wire size	solid cable		stranded cable	
	mm ²	1 x 2.5...1 x 50	mm ²	1 x 2.5...1 x 35
	AWG	1 x 13...1 x 1	AWG	1 x 13...1 x 2
Wire strip length	11			
Screw torque	4			

Remote status signalling contact specification

Contact configuration	1 CO (SPDT)		1 CO (SPDT)		1 CO (SPDT)	
Rated current	0.5/0.1		0.5/0.1		0.5/0.1	
Rated voltage	250/30		250/30		250/30	
Wire size (07P.01)	solid cable	stranded cable	solid cable	stranded cable	solid cable	stranded cable
	mm ²	1.5	1.5	1.5	1.5	1.5
	AWG	16	16	16	16	16

Approvals (according to type)



7P.09.1.255.0100



- SPD Type 1
- Spark gap module for N-PE application in three phase system, 3+1 configuration
- Remote contact signalling of GDT presence
- Upside down mounting possible
- Replaceable modules

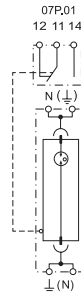

7P.01.8.260.1025



- SPD Type 1+2
- Combination of varistor and encapsulated spark gap (for single or three phase systems)
- Visual fault and remote contact fault signalling varistor/GDT status
- Upside down mounting possible
- Replaceable modules

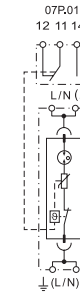

7P.02.8.260.1025



- SPD Type 1+2
- Combination of varistor and encapsulated spark gap (for single phase systems)
- Visual fault and remote contact fault signalling varistor/GDT status, N-PE GDT presence
- Upside down mounting possible
- Replaceable modules

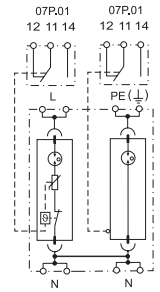

SPD Type 1+2 Surge arrester range - three phase high discharge capability with no following current - system (230/400 V)

- Surge arresters, suitable for low-voltage applications, to protect equipment against overvoltage by direct lightning strike, induced overvoltage and switching overvoltage
- To be installed at the boundary of LPZ 0 - LPZ 1 zones or higher
- Combined high energy varistor block and high-performance spark gap (GDT) ensures:
 - high discharge current
 - high insulation resistance that eliminates leakage current
 - no following current
- Very low residual voltage
- Replaceable modules
- Upside down mounting possible (thanks to dual terminal markings and new restraint system for the replaceable module that permits its inversion)
- Visual fault signalling: Healthy/Replace
- Double screw terminal
- Remote status signalling contact: Healthy/Replace/Presence. Connector 07P01 included
- According to EN 61 643-11
- 35 mm rail EN 60715 mounting, 36 mm each pole

- 7P.03.8.260.1025** SPD Type 1+2 for three phase TN-C system without Neutral (PEN conductor). Varistor + GDT protection L1, L2, L3-PEN
- 7P.04.8.260.1025** SPD Type 1+2 for three phase TT and TN-S system with Neutral. Varistor + GDT protection L1, L2, L3-N + spark gap protection N-PE
- 7P.05.8.260.1025** SPD Type 1+2 for three phase TN-S system with Neutral. Varistor + GDT protection L1, L2, L3-N + varistor + GDT protection N-PE

For outline drawing see page 15, 16

7P.03.8.260.1025



- SPD Type 1+2
- 3 x combined varistor and encapsulated spark gap
- Visual fault and remote contact fault signalling varistor/GDT status
- Upside down mounting position
- Replaceable modules

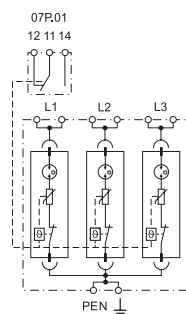

7P.04.8.260.1025



- SPD Type 1+2
- 3 x combined varistor and encapsulated spark gap + 1 encapsulated spark gap
- Visual fault and remote contact fault signalling varistor/GDT status, N-PE GDT presence
- Upside down mounting position
- Replaceable modules

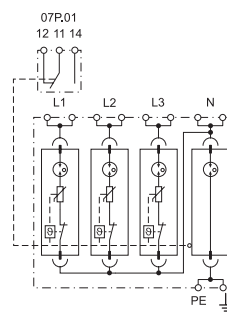

7P.05.8.260.1025



- SPD Type 1+2
- 4 x combined varistor and encapsulated spark gap
- Visual fault and remote contact fault signalling varistor/GDT status
- Upside down mounting position
- Replaceable modules

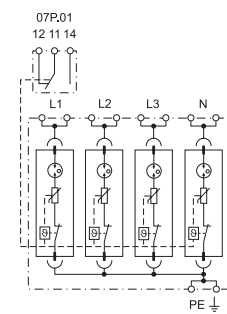

SPD specification	L-PEN	L-N	N-PE	L, N-PE		
Nominal voltage (U _N)	230	230	—	230		
Maximum operating voltage (U _C)	260	260	255	260		
Lightning impulse current (10/350 μs) (I _{imp})	25	25	100	25		
Nominal discharge current (8/20 μs) (I _n)	30	30	100	30		
Maximum discharge current (8/20 μs) (I _{max})	60	60	100	60		
Voltage protection level (U _p)	1.5	1.5	1.5	1.5		
Ability to independently switch off the following current (I _f)	No following current	No following current	100	No following current		
I _{PE}	< 4	< 4	< 4	< 4		
TOV 120 min L-N	440	440	—	440		
TOV 5 s L-N	335	335	—	335		
TOV 200 ms N-PE	—	—	1200	—		
Response time (t ₉₀)	100	100	100	100		
Short-circuit proof at maximum overcurrent protection - I _{SSCR}	50	50	—	50		
Maximum overcurrent protection (fuse rating gL/gG)	250 A	250 A	—	250 A		
Maximum overcurrent protection for serial connection	125 A gL/gG	125 A gL/gG	—	125 A gL/gG		
Replacement module code	7P00.8.260.0025	7P00.8.260.0025	7P00.1.000.0100	7P00.8.260.0025		
Other technical data						
Ambient temperature range	-40...+80					
Protection degree	IP20					
Wire size	solid cable		stranded cable			
	mm ²	1 x 2.5...1 x 50		1 x 2.5...1 x 35		
	AWG	1 x 13...1 x 1		1 x 13...1 x 2		
Wire strip length	mm		11			
Screw torque	Nm		4			
Remote status signalling contact specification						
Contact configuration	1 CO (SPDT)		1 CO (SPDT)		1 CO (SPDT)	
Rated current	A AC/DC		0.5/0.1		0.5/0.1	
Rated voltage	V AC/DC		250/30		250/30	
Wire size (07P.01)	solid cable	stranded cable	solid cable	stranded cable	solid cable	stranded cable
	mm ²	1.5	1.5	1.5	1.5	1.5
	AWG	16	16	16	16	16
Approvals (according to type)						

SPD Type 1+2 Surge arrester range with high performance "Low U_p" - Single phase/three phase system

- Surge arrester suitable for 230/400 V system applications to prevent overvoltage effects caused by direct or indirect lightning strikes
- To be installed at the boundary of LPZ 0 and LPZ 1 zones
- Very Low U_p level to protect sensitive equipment
- Visual indication of varistor status - Healthy/Replace
- Contact for remote signalling of varistor status. Connector 07P.01 included
- Replaceable spark gap and modules
- Complies with EN 61 643-11
- 17.5 mm rail EN 60715 mounting for each module

7P.12.8.275.1012 SPD Type 1+2 for single phase TT and TN-S system with Neutral.

- Varistor protection L-N + spark gap protection N-PE for single phase systems
- Replaceable spark gap and varistor modules

7P.13.8.275.1012 SPD Type 1+2 for three phase TN-C system without Neutral (PEN conductor).

- Varistor protection L1, L2, L3-PEN for three phase systems
- Replaceable varistor modules

7P.12 / 7P.13
Screw terminals



For outline drawing see page 16

SPD specification

Nominal voltage (U _N)	V AC	230	—	230
Maximum continuous operating voltage (U _c) V AC/DC		275/350	255/—	275/350
Lightning impulse current (10/350 μs) (I _{imp})	kA	12.5	25	12.5
Nominal discharge current (8/20 μs) (I _n)	kA	30	40	30
Maximum discharge current (8/20 μs) (I _{max})	kA	60	60	60
Voltage protection level (U _p)	kV	1.2	1.5	1.2
Ability to independently switch off the following current (I _n)	A	No following current	100	No following current
I _{PE}	μA	< 4		< 600
TOV 120 min L-N	V AC	440	—	440
TOV 5 s L-N	V AC	335	—	335
TOV 200 ms N-PE	V AC	—	1200	—
Response time (t _a)	ns	25	100	25
Short-circuit proof at maximum overcurrent protection - I _{SSCR}	kA _{rms}	50	—	50
Maximum overcurrent protection (fuse rating gL/gG)		160 A	—	160 A
Replacement module code		7P.10.8.275.0012	7P.10.1.000.0025	7P.10.8.275.0012

Other technical data

Ambient temperature range	°C	-40...+80		
Protection degree		IP20		
Wire size		solid cable		stranded cable
	mm ²	1 x 1...1 x 35		1 x 1...1 x 25
	AWG	1 x 17...1 x 2		1 x 17...1 x 4
Wire strip length	mm	12		
Screw torque	Nm	3		

Remote status signalling contact specification

Contact configuration		1 CO (SPDT)	—	1 CO (SPDT)
Rated current	A AC/DC	0.5/0.1	—	0.5/0.1
Rated voltage	V AC/DC	250/30	—	250/30
Wire size (07P.01)		solid cable	stranded cable	solid cable
	mm ²	1.5	1.5	1.5
	AWG	16	16	16

Approvals (according to type)



7P.12.8.275.1012



- SPD Type 1+2
- Replaceable spark gap and varistor modules (for single phase systems)
- Visual and remote signalling of varistor status

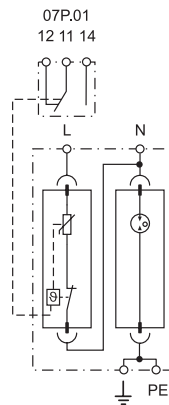

7P.13.8.275.1012



- SPD Type 1+2
- Replaceable varistor modules (for three phase systems)
- Visual and remote signalling of varistor status

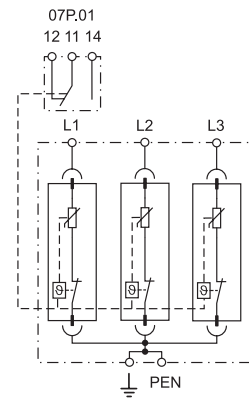

	L-N	N-PE	L-PEN	
Nominal voltage (U _N)	230	—	230	
Maximum continuous operating voltage (U _c) V AC/DC	275/350	255/—	275/350	
Lightning impulse current (10/350 μs) (I _{imp})	12.5	25	12.5	
Nominal discharge current (8/20 μs) (I _n)	30	40	30	
Maximum discharge current (8/20 μs) (I _{max})	60	60	60	
Voltage protection level (U _p)	1.2	1.5	1.2	
Ability to independently switch off the following current (I _n)	No following current	100	No following current	
I _{PE}	< 4		< 600	
TOV 120 min L-N	440	—	440	
TOV 5 s L-N	335	—	335	
TOV 200 ms N-PE	—	1200	—	
Response time (t _a)	25	100	25	
Short-circuit proof at maximum overcurrent protection - I _{SSCR}	50	—	50	
Maximum overcurrent protection (fuse rating gL/gG)	160 A	—	160 A	
Replacement module code	7P.10.8.275.0012	7P.10.1.000.0025	7P.10.8.275.0012	
Ambient temperature range	-40...+80			
Protection degree	IP20			
Wire size	solid cable		stranded cable	
	1 x 1...1 x 35		1 x 1...1 x 25	
	1 x 17...1 x 2		1 x 17...1 x 4	
Wire strip length	12			
Screw torque	3			
Contact configuration	1 CO (SPDT)	—	1 CO (SPDT)	
Rated current	0.5/0.1	—	0.5/0.1	
Rated voltage	250/30	—	250/30	
Wire size (07P.01)	solid cable	stranded cable	solid cable	
	mm ²	1.5	1.5	1.5
	AWG	16	16	16

SPD Type 1+2 Surge arrester range with high performance "Low U_p" - three phase system

- Surge arrester suitable for 230/400 V system applications to prevent overvoltage effects caused by direct or indirect lightning strikes
- To be installed at the boundary of LPZ 0 and LPZ 1 zones
- Very Low U_p level to protect sensitive equipment
- Visual indication of varistor status - Healthy/Replace
- Contact for remote signalling of varistor status. Connector 07P.01 included
- Replaceable varistor modules
- Complies with EN 61 643-11
- 17.5 mm rail EN 60715 mounting for each module

7P.14.8.275.1012 SPD Type 1+2 for three phase TT and TN-S system with Neutral.

- Varistor protection L1, L2, L3-N + spark gap protection N-PE
- Replaceable varistor modules
- Non replaceable high discharge current spark gap

7P.15.8.275.1012 SPD Type 1+2 for three phase TN-S system with Neutral.

- Varistor protection L1, L2, L3,N-PE
- Replaceable varistor modules

7P.14.8.275.1012



- SPD Type 1+2
- Replaceable varistor module
- Visual and remote signalling of varistor status

7P.15.8.275.1012



- SPD Type 1+2
- Replaceable varistor module
- Visual and remote signalling of varistor status

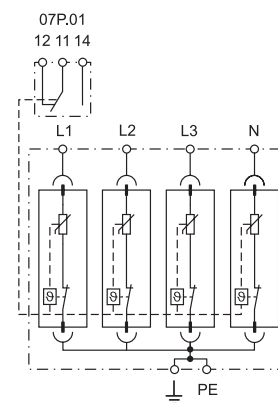
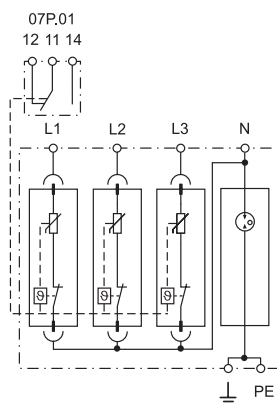

7P.14 / 7P.15

Screw terminals



For outline drawing see page 16

SPD specification	L-N	N-PE	L, N-PE
Nominal voltage (U _N)	V AC	230	230
Maximum continuous operating voltage (U _c)	V AC/DC	275/350	275/350
Lightning impulse current (10/350 μs) (I _{imp})	kA	12.5	12.5
Nominal discharge current (8/20 μs) (I _n)	kA	30	30
Maximum discharge current (8/20 μs) (I _{max})	kA	60	60
Voltage protection level (U _p)	kV	1.2	1.2
Ability to independently switch off the following current (I _f)	A	No following current	No following current
I _{PE}	uA	< 4	< 800
TOV 120 min L-N	V AC	440	440
TOV 5 s L-N	V AC	335	335
TOV 200 ms N-PE	V AC	—	1200
Response time (t _a)	ns	25	25
Short-circuit proof at maximum overcurrent protection - I _{SSCR}	kA _{rms}	50	50
Maximum overcurrent protection (fuse rating gL/gG)	A	160 A	160 A
Replacement module code		7P.10.8.275.0012	7P.10.8.275.0012
Other technical data			
Ambient temperature range	°C	-40...+80	
Protection degree		IP20	
Wire size		solid cable	stranded cable
	mm ²	1 x 1...1 x 35	1 x 1...1 x 25
	AWG	1 x 17...1 x 2	1 x 17...1 x 4
Wire strip length	mm	12	
Screw torque	Nm	3	
Remote status signalling contact specification			
Contact configuration		1 CO (SPDT)	1 CO (SPDT)
Rated current	A AC/DC	0.5/0.1	0.5/0.1
Rated voltage	V AC/DC	250/30	250/30
Wire size (07P.01)		solid cable	stranded cable
	mm ²	1.5	1.5
	AWG	16	16
Approvals (according to type)		CE ENEC	

SPD Type 2 Surge arrester range for single/ three phase AC systems and for DC systems

- Surge arrester suitable for AC and DC systems to protect equipment against induced overvoltage or switching transients
- To be installed at the boundary of LPZ 1 - LPZ 2 zones or higher
- Visual indication of varistor status - Healthy/Replace
- Contact for remote signalling of varistor status. Connector (07P.01) included (depending on the version)
- Replaceable varistor and spark gap modules
- Complies with EN 61643-11:2012
- 17.5 mm rail EN 60715 mounting for each module

7P.21.8.075.1015 SPD Type 2, unipolar protection suitable for DC applications or low voltage AC single phase systems

- Varistor protection +/- or L/N (GND); -/+ or GND (L/N)
- Replaceable module

7P.21.8.130.1015 SPD Type 2, unipolar protection suitable for DC application or low voltage AC single phase systems

- Varistor protection +/- or L/N (GND); -/+ or GND (L/N)
- Replaceable module

7P.21.8.275.x020 SPD Type 2, unipolar protection suitable to realize single phase or three phase systems (230/400 V)

- Varistor protection L/N(GND)-GND/(L/N)
- Replaceable module

7P.21.8.440.x020 SPD Type 2, unipolar protection suitable for three phase systems (400 V AC)

- Varistor protection L/N(GND)-GND/(L/N)
- Replaceable module

7P.22.8.275.x020 SPD Type 2 for single phase TT and TN-S system with Neutral

- Varistor protection L-N + spark gap protection N-PE
- Replaceable varistor and spark gap modules

7P.27.8.275.x020 SPD Type 2 for single phase TN system with Neutral

- Varistor protection L, N-PE
- Replaceable varistor modules

For outline drawing see page 16

7P.21.8.xxx.x0xx



- SPD Type 2 (1 varistor)
- Replaceable varistor module
- Visual and optional remote connector for signalling of the varistor status

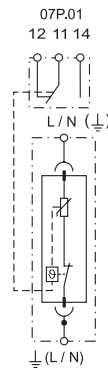

- * 7P.20.8.075.0015
- ** 7P.20.8.130.0015
- *** 7P.20.8.275.0020
- **** 7P.20.8.440.0020

7P.22.8.275.x020



- SPD Type 2 (1 varistor + 1 spark-gap)
- Combination of replaceable varistor and encapsulated spark gap modules
- Visual and optional remote connector for signalling of the varistor status

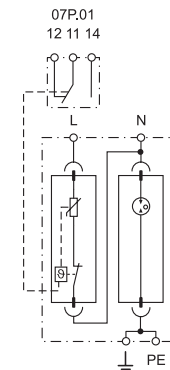

7P.27.8.275.x020



- SPD Type 2 (2 varistors)
- Replaceable varistor modules
- Visual and optional remote connector for signalling of the varistor status

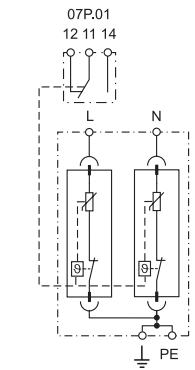

SPD specification	075.1015	130.1015	275.1020	440.1020	L-N	N-PE	L, N-PE
Nominal voltage (U _N)	60/60	110/125	230/—	400/—	230/—	—	230/—
Maximum continuous operating voltage (U _c)	75/100	130/170	275/350	440/585	275/—	255/—	275/—
Nominal discharge current (8/20 μs) (I _n)	15	15	20	20	20	20	20
Maximum discharge current (8/20 μs) (I _{max})	40	40	40	40	40	40	40
Voltage protection level at 5 kA (U _{p5})	0.3	0.45	0.9	1.5	0.9	—	0.9
Voltage protection level at I _n (U _p)	0.4	0.6	1.2	1.9	1.2	1.5	1.2
I _{PE}	< 350	< 350	< 200	< 350	< 4		< 400
TOV 120 min L-N	115	225	440	—	440	—	440
TOV 5 s L-N	90	175	335	580	335	—	335
TOV 200 ms N-PE	—	—	—	—	—	1200	—
Response time (t _a)	25				25	100	25
Short-circuit proof at maximum overcurrent protection - I _{SSCR}					50	—	50
Maximum overcurrent protection (fuse rating gL/gG)					160 A	—	160 A
Replacement module code	*	**	***	****	7P.20.8.275.0020	7P.20.1.000.0020	7P.20.8.275.0020
Other technical data							
Ambient temperature range	-40...+80						
Protection degree	IP20						
Wire size	solid cable				stranded cable		
	mm ²				1 x 1...1 x 25		
	AWG				1 x 17...1 x 4		
Wire strip length	mm				12		
Screw torque	Nm				3		
Remote status signalling contact specification							
Contact configuration	1 CO (SPDT)				1 CO (SPDT)		
Rated current	A AC/DC				0.5/0.1		
Rated voltage	V AC/DC				250/30		
Wire size (07P.01)	solid cable		stranded cable		solid cable		stranded cable
	mm ²		1.5		1.5		1.5
	AWG		16		16		16

Approvals (according to type)



SPD Type 2 Surge arrester range - three phase systems

- Surge arrester suitable for 230/400 V system applications to protect equipments against induced overvoltage or switching transients
- To be installed at the boundary of LPZ 1 - LPZ 2 zones or higher
- Visual indication of varistor status - Healthy/Replace
- Contact for remote signalling of varistor status. Connector (07P.01) included (depending on the version)
- Replaceable varistor and spark gap modules
- Complies with EN 61643-11:2012
- 35 mm rail (EN 60715) mounting

7P.23.8.275.x020 SPD Type 2 for three phase TN-C system without Neutral (PEN conductor).

- Varistor protection L1, L2, L3-PEN
- Replaceable varistor module

7P.24.8.275.x020 SPD Type 2 for three phase TT and TN-S system with Neutral.

- Varistor protection L1, L2, L3 + spark gap protection N-PE
- Replaceable varistor and spark gap modules

7P.25.8.275.x020 SPD Type 2 for three phase TN-S system with Neutral.

- Varistor protection L1, L2, L3, N-PE
- Replaceable varistor module

7P.23.8 / 7P.24 / 7P.25

Screw terminals



For outline drawing see page 17

SPD specification

	L - PEN	L-N	N-PE	L, N-PE
Nominal voltage (U _N)	230	230	—	230
Maximum continuous operating voltage (U _C) V AC/DC	275/350	275/—	255/—	275/350
Nominal discharge current (8/20 μs) (I _n)	20	20	20	20
Maximum discharge current (8/20 μs) (I _{max})	40	40	40	40
Voltage protection level at 5 kA (U _{PS})	0.9	0.9	—	0.9
Voltage protection level at I _n (U _p)	1.2	1.2	1.5	1.2
I _{PE}	< 600	< 4		< 800
TOV 120 min L-N	440	440	—	440
TOV 5 s L-N	335	335	—	—
TOV 200 ms N-PE	—	—	1200	—
Response time (t _a)	25	25	100	25
Short-circuit proof at maximum overcurrent protection - I _{SSCR}	50	50	—	50
Maximum overcurrent protection (fuse rating gL/gG)	160 A	160 A	—	160 A
Replacement module code	7P.20.8.275.0020	7P.20.8.275.0020	7P.20.1.000.0020	7P.20.8.275.0020

Other technical data

Ambient temperature range	-40...+80			
Protection degree	IP20			
Wire size	solid cable		stranded cable	
	mm ²	1 x 1...1 x 35	1 x 1...1 x 25	
	AWG	1 x 17...1 x 2	1 x 17...1 x 4	
Wire strip length	mm 12			
Screw torque	Nm 3			

Remote status signalling contact specification

	1 CO (SPDT)		1 CO (SPDT)		1 CO (SPDT)	
Contact configuration						
Rated current	A AC/DC 0.5/0.1		0.5/0.1		0.5/0.1	
Rated voltage	V AC/DC 250/30		250/30		250/30	
Wire size (07P.01)	solid cable	stranded cable	solid cable	stranded cable	solid cable	stranded cable
	mm ²	1.5	1.5	1.5	1.5	1.5
	AWG	16	16	16	16	16

Approvals (according to type)



7P.23.8.275.x020



- SPD Type 2 (3 varistors)
- Replaceable varistor module, 3 pole
- Visual and remote signalling of varistor status

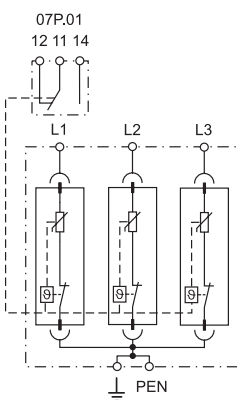

7P.24.8.275.x020



- SPD Type 2 (3 varistors + 1 spark-gap)
- Combination of replaceable varistor and encapsulated spark gap modules
- Visual and optional remote connector for signalling of the varistor status

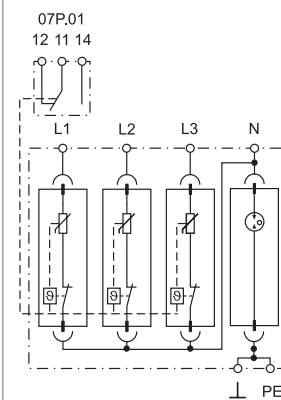

7P.25.8.275.x020



- SPD Type 2 (4 varistors)
- Replaceable varistor module, 4 pole
- Visual and optional remote connector for signalling of the varistor status

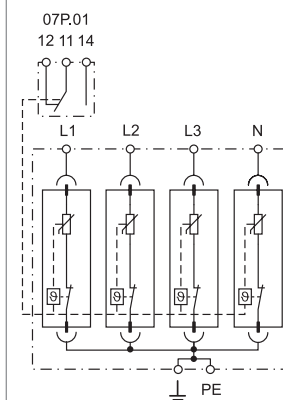

SPD Type 2 Surge arrester range for Photovoltaic applications

- Surge arrester for protection of DC side (420 V to 1200 V) of systems in photovoltaic applications
- Protects equipment against induced overvoltage caused by lightning strikes or switching transients

7P.26.9.420.1020, $U_{CPV} = 420$ V DC

7P.23.9.750.x020, $U_{CPV} = 750$ V DC

7P.23.9.500.1015, $U_{CPV} = 1500$ V DC

- Visual indication of varistor status - Healthy/Replace
- Contact for remote signalling of varistor status. Connector (07P.01) included (depending on the version)
- Replaceable modules
- Complies with prEN 50539-11:2012
- 35 mm rail (EN 60715) mounting

7P.23.9 / 7P.26
Screw terminals



For outline drawing see page 17

SPD specification

Maximum operating voltage (U_{CPV})	V DC	420		750	1500
Maximum operating voltage/per module (U_{CPV})	VDC	375	420	375	750
Nominal discharge current/ per module (8/20 μ s) (I_n)	kA	20	20	20	15
Maximum discharge current/ per module (8/20 μ s) (I_{max})	kA	40	40	40	30
Voltage protection level/per module (U_p)	kV	1.8	1.5	1.8	3.2
Voltage protection level of the system $U_p (+ \rightarrow -)/(+/- \rightarrow PE)$	kV	3.6/1.5		3.6/3.6	6.4/6.4
Residual current ($+ \rightarrow -)/(+/- \rightarrow PE)$	μ A	< 1		< 5	< 5
Response time (t_a)	ns	25	100	25	25
Short circuit current withstand I_{SCPV}	A	63	—	1000	1000
Replacement module code		7P.20.9.375.0020	—	7P.20.9.375.0020	7P.20.9.750.0015

Other technical data

Ambient temperature range	$^{\circ}$ C	-40...+80			
Protection degree		IP20			
Wire size		solid cable		stranded cable	
	mm^2	1 x 1...1 x 35		1 x 1...1 x 25	
	AWG	1 x 17...1 x 2		1 x 17...1 x 4	
Wire strip length	mm	14			
Screw torque	Nm	3			

Remote status signalling contact specification

Contact configuration		1 CO (SPDT)		1 CO (SPDT)		1 CO (SPDT)	
Rated current	A AC/DC	0.5/0.1		0.5/0.1		0.5/0.1	
Rated voltage	V AC/DC	250/30		250/30		250/30	
Wire size (07P.01)		solid cable	stranded cable	solid cable	stranded cable	solid cable	stranded cable
	mm^2	1.5	1.5	1.5	1.5	1.5	1.5
	AWG	16	16	16	16	16	16

Approvals (according to type)



7P.26.9.420.1020



- SPD Type 2 (2 varistors + 1 spark-gap) for 420 V DC photovoltaic systems
- Combination of replaceable varistor and encapsulated spark gap modules
- Visual and remote signalling of varistor status

7P.23.9.750.x020



- SPD Type 2 (3 varistors) for 750 V DC photovoltaic systems
- Replaceable varistor modules
- Visual and optional remote connector for signalling of the varistor status

7P.23.9.500.1015



- SPD Type 2 (3 varistors) for 1500 V DC photovoltaic systems
- Replaceable varistor modules
- Visual and remote signalling of varistor status

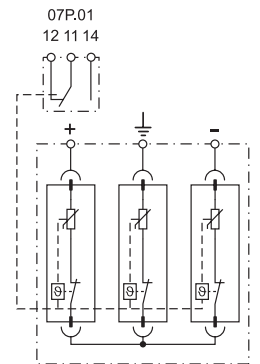
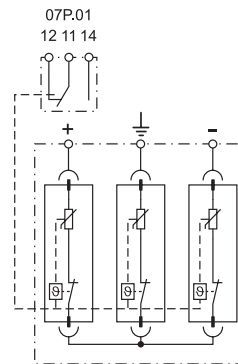
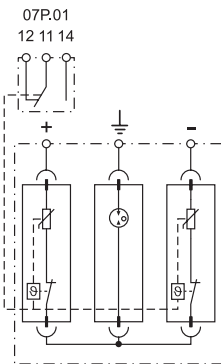

Varistor module	Spark-gap module
-----------------	------------------

Maximum operating voltage (U_{CPV})	V DC	420	750
Maximum operating voltage/per module (U_{CPV})	VDC	375	420
Nominal discharge current/ per module (8/20 μ s) (I_n)	kA	20	20
Maximum discharge current/ per module (8/20 μ s) (I_{max})	kA	40	40
Voltage protection level/per module (U_p)	kV	1.8	1.5
Voltage protection level of the system $U_p (+ \rightarrow -)/(+/- \rightarrow PE)$	kV	3.6/1.5	
Residual current ($+ \rightarrow -)/(+/- \rightarrow PE)$	μ A	< 1	
Response time (t_a)	ns	25	100
Short circuit current withstand I_{SCPV}	A	63	—
Replacement module code		7P.20.9.375.0020	—

Varistor module

Maximum operating voltage (U_{CPV})	V DC	750
Maximum operating voltage/per module (U_{CPV})	VDC	375
Nominal discharge current/ per module (8/20 μ s) (I_n)	kA	20
Maximum discharge current/ per module (8/20 μ s) (I_{max})	kA	40
Voltage protection level/per module (U_p)	kV	1.8
Voltage protection level of the system $U_p (+ \rightarrow -)/(+/- \rightarrow PE)$	kV	3.6/3.6
Residual current ($+ \rightarrow -)/(+/- \rightarrow PE)$	μ A	< 5
Response time (t_a)	ns	25
Short circuit current withstand I_{SCPV}	A	1000
Replacement module code		7P.20.9.375.0020

Varistor module

Maximum operating voltage (U_{CPV})	V DC	1500
Maximum operating voltage/per module (U_{CPV})	VDC	750
Nominal discharge current/ per module (8/20 μ s) (I_n)	kA	15
Maximum discharge current/ per module (8/20 μ s) (I_{max})	kA	30
Voltage protection level/per module (U_p)	kV	3.2
Voltage protection level of the system $U_p (+ \rightarrow -)/(+/- \rightarrow PE)$	kV	6.4/6.4
Residual current ($+ \rightarrow -)/(+/- \rightarrow PE)$	μ A	< 5
Response time (t_a)	ns	25
Short circuit current withstand I_{SCPV}	A	1000
Replacement module code		7P.20.9.750.0015

SPD Type 1+2 and Type 2 Surge arrester range for Photovoltaic applications

- Surge arrester for protection of DC side (1020 V) of systems in photovoltaic applications
- Protects equipment against overvoltage caused by direct lightning strike (Type 1+2 only) and induced overvoltages (Type 1+2 and Type 2)

7P.26.9.000.x015, $U_{CPV} = 1020$ V DC (Type 2)

7P.23.9.000.x015, $U_{CPV} = 1020$ V DC (Type 2)

7P.03.9.000.1012, $U_{CPV} = 1000$ V DC (Type 1+2)

- Visual indication of varistor status - Healthy/Replace
- Contact for remote signalling of varistor status. Connector (07P.01) included (depending on the version)
- Replaceable modules
- Complies with prEN 50539-11:2012
- 35 mm rail (EN 60715) mounting

7P.26.9.000.x015



- SPD Type 2 (2 varistors + 1 spark-gap) for 1020 V DC photovoltaic systems
- Combination of replaceable varistor and encapsulated spark gap modules
- Visual and optional remote connector for signalling of the varistor status

7P.23.9.000.x015



- SPD Type 2 (3 varistors) for 1020 V DC photovoltaic systems
- Replaceable varistor modules
- Visual and optional remote connector for signalling of the varistor status

7P.03.9.000.1012



- SPD Type 1+2 (3 varistors) for 1000 V DC photovoltaic systems
- Replaceable varistor modules
- Visual and remote signalling of varistor status

7P.23.9 / 7P.26 / 7P.03
Screw terminals

E

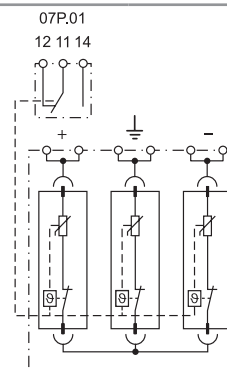
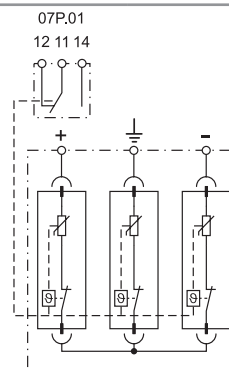
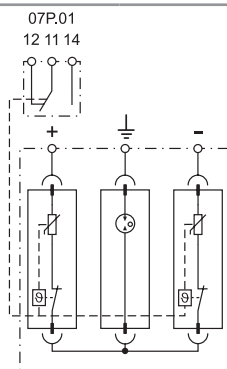

For outline drawing see page 17

SPD specification	Varistor module	Spark-gap module	Varistor module	Varistor module
Maximum operating voltage (U_{CPV}) V DC	1020		1020	1000
Maximum operating voltage/per module (U_{CPV}) V DC	510	1020	510	500
Lightning impulse current (10/350 μ s)/per module (I_{mp}) kA	—	—	—	12.5
Nominal discharge current/per module (8/20 μ s) (I_n) kA	15	15	15	30
Maximum discharge current/per module (8/20 μ s) (I_{max}) kA	30	30	30	60
Voltage protection level/per module (U_p) kV	2	2.5	2	1.8
Voltage protection level of the system U_p (+ \rightarrow -)/(+/- \rightarrow PE) kV	4/2.5		4/4	3.6/3.6
Residual current (+ \rightarrow -)/(+/- \rightarrow PE) μ A	< 1		< 5	< 5
Response time (t_a) ns	25	100	25	25
Short circuit current withstand I_{SCPV} A	1000	—	1000	1000
Replacement module code	7P.20.9.500.0015	7P.20.1.000.9015	7P.20.9.500.0015	7P.00.9.500.0012
Other technical data				
Ambient temperature range $^{\circ}$ C	-40...+80			
Protection degree	IP20			
Wire size	solid cable		stranded cable	
	mm ²		1 x 1...1 x 35	
	AWG		1 x 17...1 x 2	
Wire strip length mm	14			9
Screw torque Nm	3			4
Remote status signalling contact specification				
Contact configuration	1 CO (SPDT)		1 CO (SPDT)	
Rated current A AC/DC	0.5/0.1		0.5/0.1	
Rated voltage V AC/DC	250/30		250/30	
Wire size (07P.01)	solid cable		solid cable	
	mm ²		1.5	
	AWG		16	
Approvals (according to type)				

SPD Type 3, Surge arrester for TT and TN-S system (with Neutral)

Single phase applications within socket outlets and 35 mm rail mounting

- Protects electrical and electronic equipment sensitive to impulse overvoltage
- Varistor and spark gap (GDT) combination avoiding earth leakage current
- Conforms to EN 61643-11:2012

7P.31.8.275.0005

- Unipolar protection (L/N)
- IP 65 SPD
- LED indication of need to replace the SPD
- 2 wires, 150 mm long, for ease of connection

7P.32.8.275.0005

- "1+1" configuration: varistor + spark gap with very low U_p level
- IP 65 SPD
- LED indication of need to replace the SPD
- 3 wires, 150 mm long, for ease of connection

NEW 7P.31.8.275.0005

NEW 7P.32.8.275.0005



- SPD Type 3
- Unipolar protection suitable also for LED lamp protection
- IP 65

- SPD Type 3
- "1+1" configuration suitable also for LED lamp protection
- IP 65

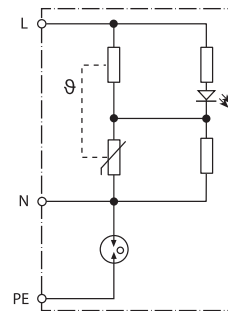
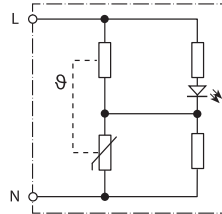

* see diagram L7P page 23

For outline drawing see page 17, 18

SPD specification

Nominal voltage (U_N)	V AC	230	230
Maximum continuous operating voltage (U_C)	V AC	275	275
Nominal discharge current (8/20 μ s)			
L-N, L(N)-PE (I_n)	kA	5/—	5/5
Maximum discharge current (8/20 μ s)			
L-N, N-PE (I_{max})	kA	10/—	10/10
Test voltage of the combined generator			
L-N, L(N)-PE (U_{oc})	kV	10/—	10/10
Voltage protection level L-N, L(N)-PE (U_p)	kV	1.6/—	1.65/1.5
Response time L-N, L(N)-PE (t_a)	ns	25/—	25/100
Short-circuit proof at maximum overcurrent protection - I_{SSCR}	kA_{rms}	1.5	1.5
Maximum overcurrent protection		16 A gL/gG, B16 A, C10 A	16 A gL/gG, B16 A, C10 A
Other technical data			
Ambient temperature range	$^{\circ}C$	-25...+80	-25...+80
Protection degree		IP 65	IP 65

Approvals (according to type)



E

SPD Type 3, Surge arrester for TT and TN-S system (with Neutral)

Single phase applications within socket outlets and 35 mm rail mounting

- Protects electrical and electronic equipment sensitive to impulse overvoltage
- Varistor and spark gap (GDT) combination avoiding earth leakage current
- Conforms to EN 61643-11:2012

7P.36.8.275.2003

- Provides easy additional surge protection for 230 V sockets
- "Y" configuration: varistor + spark gap with very low U_p level
- Audible indication of need to replace varistor and jumper test point for SPD status
- 3-wires, 150 mm long, for connection to socket terminals

7P.37.8.275.1003

- "1+1" configuration: varistor + spark gap with very low U_p level
- Permits serial connection for optimized load protection up to 16 A
- Integral CO contact for remote signalling of varistor status - contact gold plated for reliable low level switching
- 17.5 mm L-N/N-PE protection
- Mounting on 35 mm DIN rail (EN 60715)

NEW 7P.36.8.275.2003



- SPD Type 3
- "Y" configuration
- Audible (buzzing) signalling of varistor fault

7P.37.8.275.1003



- SPD Type 3
- "1+1" configuration
- Series connection for protection of loads up to 16 A
- Remote signalling of varistor status by integral change-over relay contact

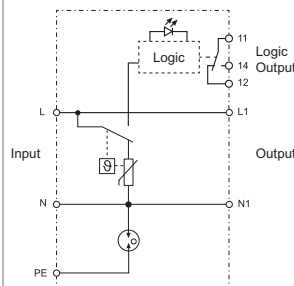
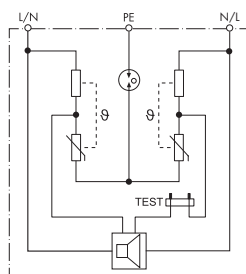

* see diagram L7P page 23
For outline drawing see page 17, 18

SPD specification

Nominal voltage (U_N)	V AC	230	230
Maximum continuous operating voltage (U_C)	V AC	275	275
Rated load current (I_L)	A	—	16
Nominal discharge current (8/20 μ s)			
L-N, L(N)-PE (I_n)	kA	3/3	3/3
Test voltage of the combined generator			
L-N, L(N)-PE (U_{OC})	kV	6/6	6/6
Voltage protection level L-N, L(N)-PE (U_p)	kV	1.65/1.5	1/1.5
Response time L-N, L(N)-PE (t_a)	ns	25/100	25/100
Short-circuit proof at maximum overcurrent protection - I_{SSCR}	kA_{rms}	1.5	5
Maximum overcurrent protection		16 A gL/gG, B16A, C10A	16 A gL/gG, B16A, C16A
Other technical data			
Ambient temperature range	$^{\circ}C$	-20...+70	-25...+70*
Protection degree		IP 20	IP 20
Wire size		—	solid cable stranded cable
	mm^2	—	0.5...6 0.5...4
	AWG	—	20...10 20...12
Wire strip length	mm	—	9
Screw torque	Nm	—	0.8
Remote status signalling contact specification			
Contact configuration		—	1 CO (SPDT)
Rated current	A AC	—	0.5
Rated voltage	V AC	—	230
Breaking capacity DC1: 30/110	A	—	2/0.3
Minimum switching load	mW (V/mA)	—	10 (5/5)
Contact material		—	AgNi + Au
Approvals (according to type)		CE EAC	

SPD Type 2+3 with combination of coarse and fine suppression for 2 wires telecommunication and signalling network

- Suitable for the protection of 2 wires data lines and telecommunication interface allowing continuity of the shield
- Permits serial connection optimizing the fine protection of longitudinal overvoltage (core-PG) and lateral overvoltage (core-core)
- Conform to EN 61643-21+A1,A2:2013, EN IEC61643-21+A1,A2:2012 C2,C3
- DIN rail mounting

7P.62.9.009.0485

- Suitable for the protection of RS485 data lines of inverter, PLC, energy meters or other interfaces

7P.62.9.036.0005

- Suitable for the protection of fire detection systems, telecommunications interfaces and 2-wire data lines

NEW 7P.62.9.009.0485



- SPD Type 2+3
- Protection of RS485 data lines, telecommunication and other Bus lines

NEW 7P.62.9.036.0005



- SPD Type 2+3
- Protection of fire detection systems, telecommunication and other data/Bus lines

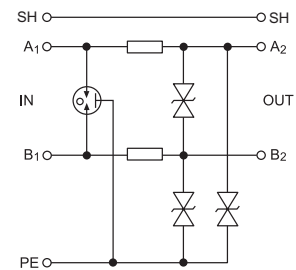
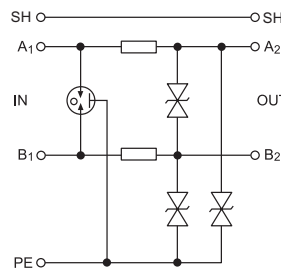

For outline drawing see page 18

SPD specification

Nominal voltage (U_N)	V DC	6	24
Maximum operating voltage (U_C)	V DC	8.5	36
Nominal load current (I_L)	A	0.5	0.5
C2 nominal discharge current (8/20 μ s) core-core (I_n)	kA	5	5
C2 total discharge current (8/20 μ s) cores-PE (C)	kA	10	10
C2 voltage protection level mode core-core @ I_n (U_p)	V	18	50
C2 voltage protection level mode core-PE @ I_n (U_p)	V	30	65
C3 voltage protection level mode core-core @ 1 kV/ μ s (U_p)	V	12	45
C3 voltage protection level mode core-PE @ 1 kV/ μ s (U_p)	V	15	45
Response time core-core/core-PE (t_a)	ns	1/1	1
Serial resistance per core (R)	Ω	1.6	1.6
Threshold frequency core-core (f)	MHz	1	4

Other technical data

Range of operating temperature	$^{\circ}$ C	-40...+70	-40...+70		
Degree of protection		IP 20	IP 20		
Wire size		solid cable	stranded cable	solid cable	stranded cable
	mm ²	4	2.5	4	2.5
	AWG	12	14	12	14

Approvals (according to type)



Data line SPD for Ethernet Cat. 6

- Suitable for Ethernet, POE (Power over Ethernet) and dataline transmission system up to 250 MHz
- Protection of all pairs of conductors with minimum attenuation
- Aluminum chassis and RJ45 in metal screens
- Included accessories for simple installation near the equipment to be protected, LPZ boundary 2-3 (Type 3)
- Complies to EN 61643-21
- Mounting on 35 mm DIN rail

NEW 7P.68.9.060.0600

- Ethernet Cat 6 - 60 V
- Shielded RJ45 connectors

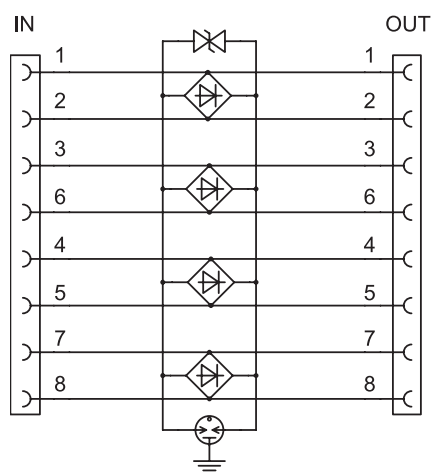

For outline drawing see page 18

SPD specification

Nominal voltage of system (U_N)	V DC	48
Maximum operating voltage (U_C)	V DC	60
Nominal current (I_L)	mA	500
C2 total nominal discharge current (8/20 μ s) line - PG (I_n)	kA	1.6
C2 nominal discharge current (8/20 μ s) line-line (I_n)	A	200
Voltage protection level line-line @ I_n (C2) - (U_p)	V	40
Voltage protection level line-PG @ I_n (C2) - (U_p)	V	350
Voltage protection level line-line @ 1 kV/ μ s (C3) - (U_p)	V	65
Insertion attenuation @ 250 MHz	dB	< 2
Response time	ns	1
Other technical data		
Ambient temperature range	°C	-40...+80
Degree of protection		IP 20
Input-Output connection		RJ45/RJ45 shielded
Approvals (according to type)		CE

Ordering information

Example: 7P series, surge protection device, Type 2, single phase ($U_c = 275$ V), 1 varistor + 1 encapsulated spark gap, with remote status signalling contact, $I_n = 20$ kA

7 P . 2 2 . 8 . 2 7 5 . 1 0 2 0

Series

Type

- 0 = Combined type 1 + 2 arresters high discharge capability
- 1 = Type 1+2 high performance "Low U_p " surge arresters
- 2 = Type 2 surge arresters
- 3 = Type 3 surge arresters
- 6 = Data line SPD

Circuit

- 1 = Single phase (1 varistor)
- 2 = Single phase (1 varistor + 1 spark-gap), protected poles (data line SPD)
- 2 = Protected poles (Data line SPD)
- 3 = Three-phase (3 varistors)
- 4 = Three-phase (3 varistors + 1 spark-gap)
- 5 = Three-phase (4 varistors)
- 6 = 2 varistors + 1 spark-gap
- 6 = 1 varistors + 1 spark-gap(7P.36)
- 7 = Single phase (2 varistors) Type 2 (7P.27)
- 7 = Single phase (1 varistor + 1 spark gap) Type 3, DIN rail mounting (7P.37)
- 8 = Protected poles (Data line SPD)
- 9 = N-PE spark-gap for three phase system
- 0 = Spare module

Supply version

- 1 = N+PE connection (only for single spark gap replaceable module and 7P.09)
- 8 = AC (50/60 Hz)
- 9 = DC (PV application and Data line SPD)

Supply voltage

- 000 = N+PE connection for spark gap modules
- 009 = 8.5 V DC Max (U_c) SPD Data line SPD
- 036 = 36 V DC Max (U_c) SPD Data line SPD
- 060 = 60 V DC Max (U_c), Data line SPD
- 075 = 75 V AC Max
- 130 = 130 V AC Max
- 440 = 440 V Max (U_c) for SPD Type 2 (for $U_N = 400$ V AC)
- 275 = 275 V Max for SPD Type 1+2 "Low U_p ", Type 2 (U_c) (for $U_N = 230-240$ V AC) and Type 3
- 260 = 260 V Max (U_c) for SPD Type 1+ 2 (for $U_N = 230-240$ V AC)
- 255 = 255 V Max (U_c) for SPD Type 1, N+PE (7P.09)

Nominal discharge current

- 100 = 100 kA (I_{imp} Type 1) only for 7P.09, N-PE GDT for 7P.04
- 050 = 50 kA (I_{imp} Type 1 N-PE GDT for 7P.02)
- 025 = 25 kA (I_{imp} Type 1+2)
- 020 = 20 kA (I_n Type 2)
- 015 = 15 kA (I_n Type 2)
- 012 = 12.5 kA (I_{imp} Type 1+2)
- 003 = 3 kA ($I_n @ U_{oc}$ only for 7P.36 and 7P.37)
- 005 = 5 kA ($I_n @ U_{oc}$ for 7P.31, 7P.32 and 7P.62)
- 485 = RS485 Modbus protocol (Data line SPD)
- 600 = Ethernet Cat 6 (Data line SPD)

Remote status signalling contact

- 0 = Without remote status signalling contact (only some Type 2 SPD and Data line)
- 1 = Built-in remote status signalling contact
- 2 = Acoustic fault signalling

Supply voltage PV SPD

- UCPV $\geq 1.2 U_{oc}$ STC**
- 000 = 1000 V DC UCPV SPD T1+2 (7P.03.9), 1020 V DC UCPV PV SPD T2 (7P.23.9, 7P.26.9)
- 420 = 420 V DC UCPV
- 500 = 1500 V DC UCPV
- 750 = 750 V DC UCPV

Upside down mounting

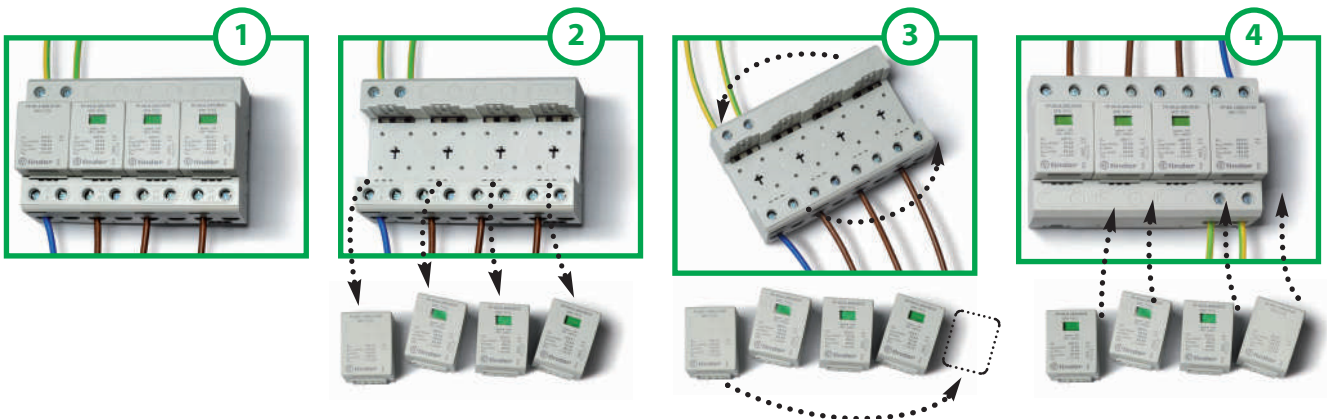

Replaceable modules



Replacement varistor and modules	7P.00.8.260.0025	7P.00.9.500.0012	7P.00.1.000.0050	7P.00.1.000.0100
	Varistor	Varistor	Spark-Gap	Spark-Gap
Maximum operating voltage (U_c/U_{CPV}) V AC/DC	260/—	—/500	255/—	255/—
Lightning Impulse current (10/350 μ s) (I_{imp}) kA	25	12.5	50	100
Nominal discharge current (8/20 μ s) (I_n) kA	30	30	50	100
Maximum discharge current (8/20 μ s) (I_{max}) kA	60	60	100	100
Voltage protection level (U_p) kV	1.5	1.8	1.5	1.5
Leakage current (@ 253 V AC) & I_{pe} current μ A	< 4	< 4	< 4	< 4
Response time (t_a) ns	100	25	100	100
Maximum overcurrent protection	250 A gL/gG	—	—	—



Replacement varistor and modules	7P.10.8.275.0012	7P.10.1.000.0025
	Varistor	Spark-Gap
Maximum operating voltage (U_c) V AC/DC	275/350	255/--
Lightning Impulse current (10/350 μ s) (I_{imp}) kA	12.5	25
Nominal discharge current (8/20 μ s) (I_n) kA	30	40
Maximum discharge current (8/20 μ s) (I_{max}) kA	60	60
Voltage protection level (U_p) kV	1.2	1.5
Response time (t_a) ns	25	100
Maximum overcurrent protection	160 A gL/gG	—



Replacement varistor modules	7P.20.8.075.0015	7P.20.8.130.0015	7P.20.8.275.0020	7P.20.8.440.0020
	Varistor	Varistor	Varistor	Varistor
Maximum operating voltage (U_c) V AC/DC	75/100	130/170	275/350	440/585
Nominal discharge current (8/20 μ s) (I_n) kA	15	15	20	20
Maximum discharge current (8/20 μ s) (I_{max}) kA	40	40	40	40
Voltage protection level (U_p) kV	0.4	0.6	1.2	1.5
Response time (t_a) ns	25	25	25	25
Maximum overcurrent protection	160 A gL/gG	160 A gL/gG	160 A gL/gG	125 A gL/gG



Replacement varistor modules	7P.20.9.375.0020	7P.20.9.500.0015	7P.20.9.750.0015
	Varistor	Varistor	Varistor
Maximum operating voltage (U_c/U_{CPV}) V AC/DC	—/375	—/510	—/750
Nominal discharge current (8/20 μ s) (I_n) kA	20	15	15
Maximum discharge current (8/20 μ s) (I_{max}) kA	40	30	30
Voltage protection level (U_p) kV	1.8	2	3.2
Response time (t_a) ns	25	25	25
Maximum overcurrent protection	—	—	—



Replacement modules	7P.20.1.000.0020	7P.20.1.000.9015
	Spark-Gap	Spark-Gap
Maximum operating voltage (U_c/U_{CPV}) V AC/DC	255/—	—/1020
Nominal discharge current (8/20 μ s) (I_n) kA	20	15
Maximum discharge current (8/20 μ s) (I_{max}) kA	40	30
Voltage protection level (U_p) kV	1.5	2.5
Response time (t_a) ns	100	100
Maximum overcurrent protection	—	—

Temporary Overvoltage (TOV)	7P.32, 7P.36, 7P.37
Transient OverVoltage 5 s L-N (U_{TOV}) V	335
Transient OverVoltage 5 s L-PE (U_{TOV}) V	400
Transient OverVoltage 200 ms L-PE (U_{TOV}) V	1430

Outline drawings

Type 7P.09
Screw terminal

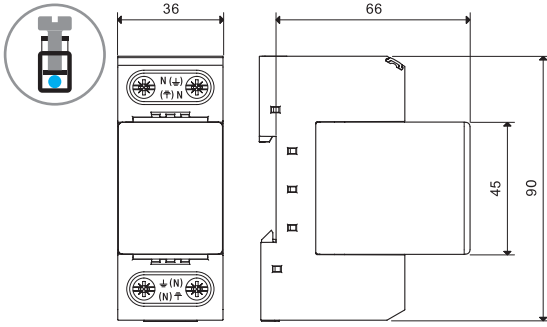

Type 7P.01
Screw terminal

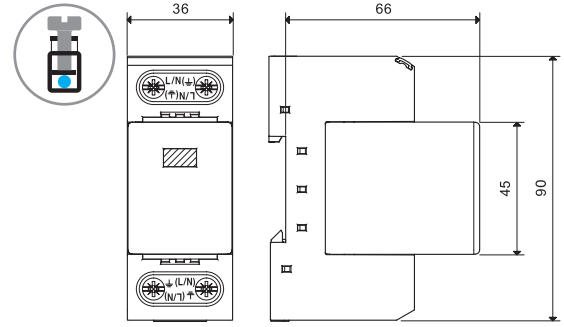

Type 7P.02
Screw terminal

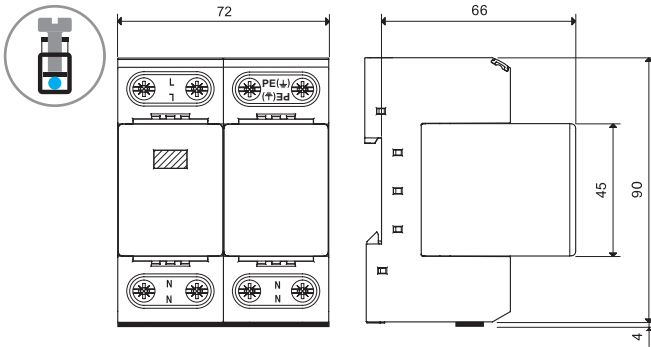

Type 7P.03
Screw terminal

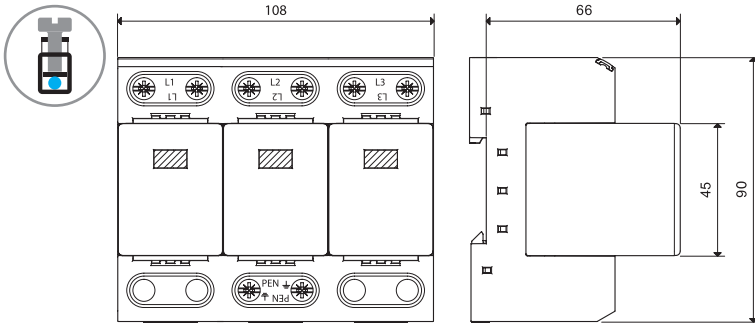

Type 7P.04
Screw terminal

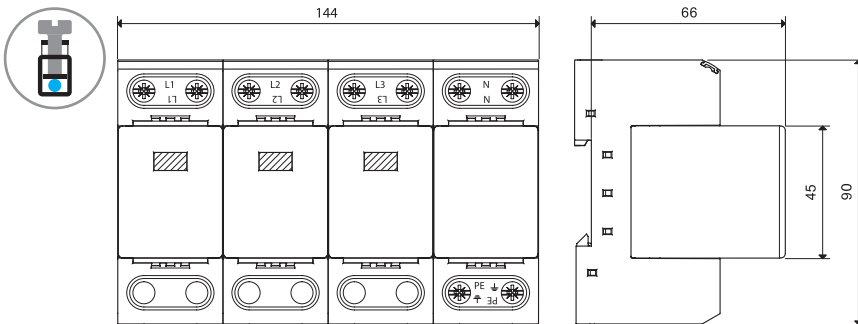

E

Outline drawings

Type 7P.05
Screw terminal

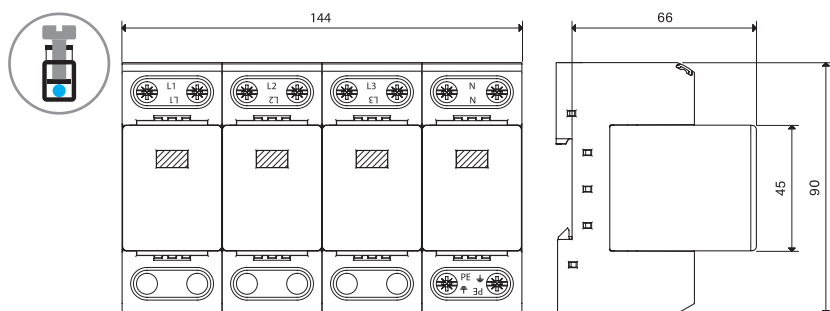

Type 7P.12
Screw terminal

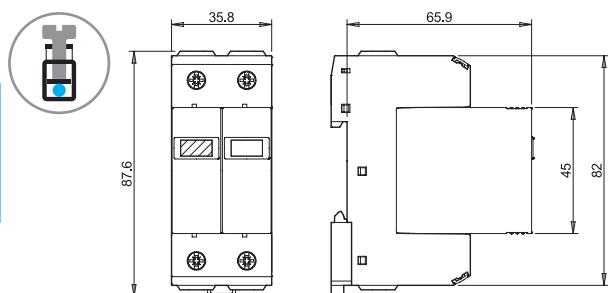

Type 7P.13
Screw terminal

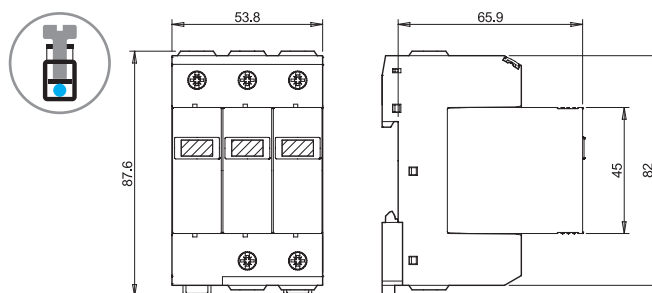

Type 7P.14
Screw terminal

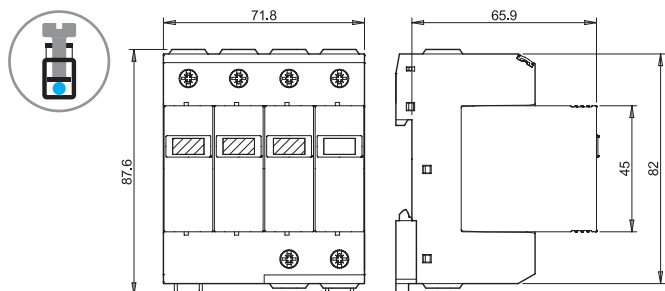

Type 7P.15
Screw terminal

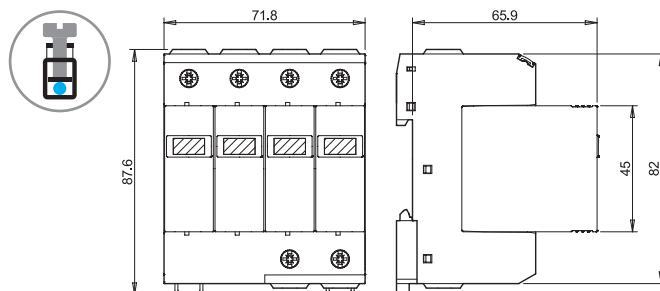

Type 7P.21
Screw terminal

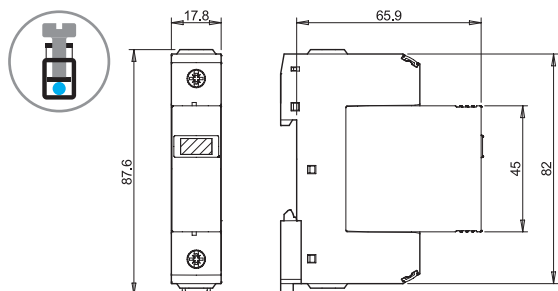

Type 7P.22 / 7P.27
Screw terminal

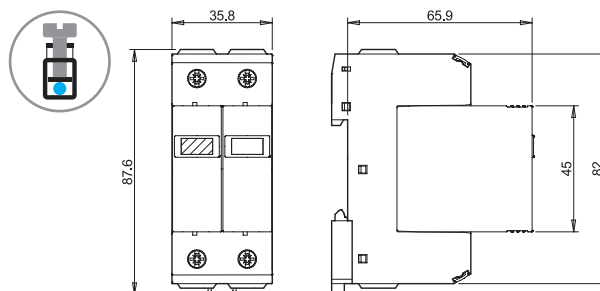

E

Outline drawings

Type 7P.23.8
Screw terminal

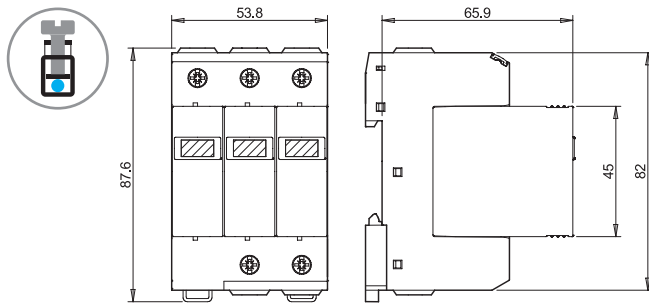

Type 7P.24
Screw terminal

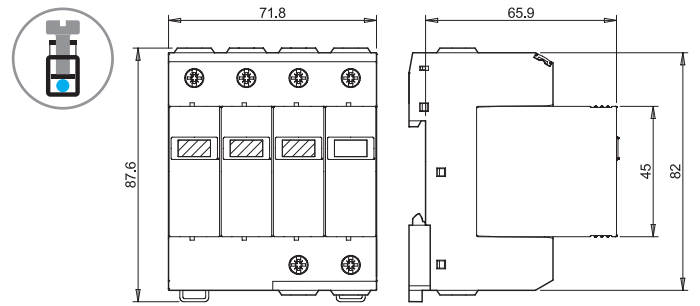

Type 7P.23.9
Screw terminal

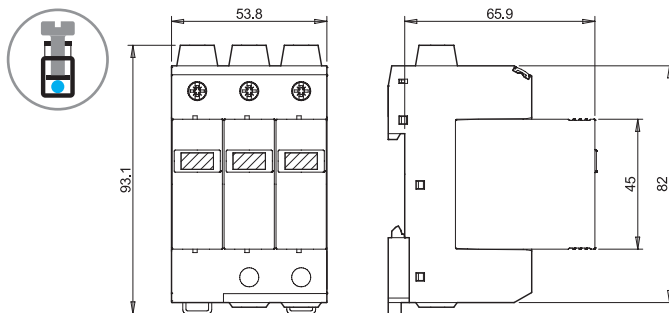

Type 7P.25
Screw terminal

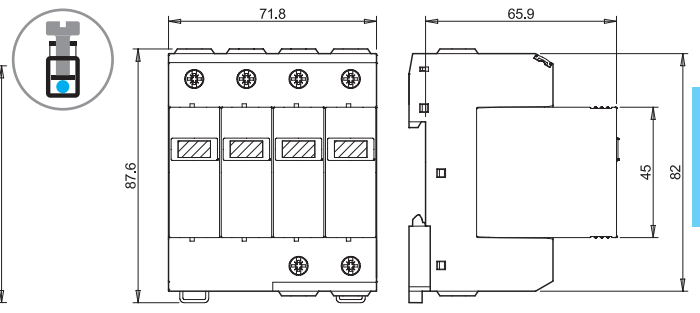

Type 7P.26.9.000.1015
Screw terminal

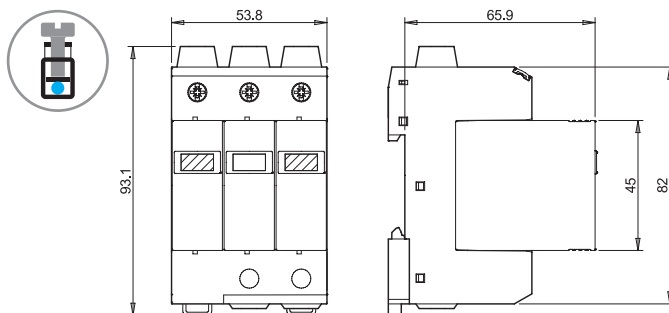

Type 7P.26.9.420.1020
Screw terminal

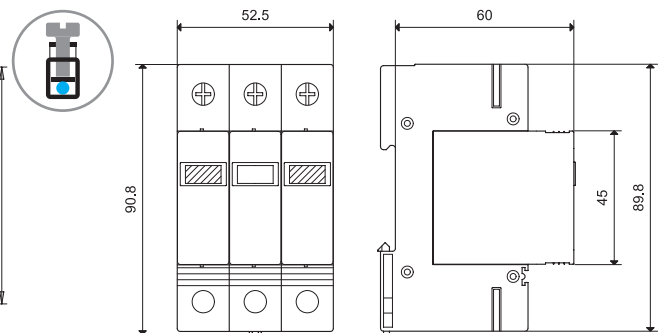

Type 7P.23.9.000.6020
Screw terminal

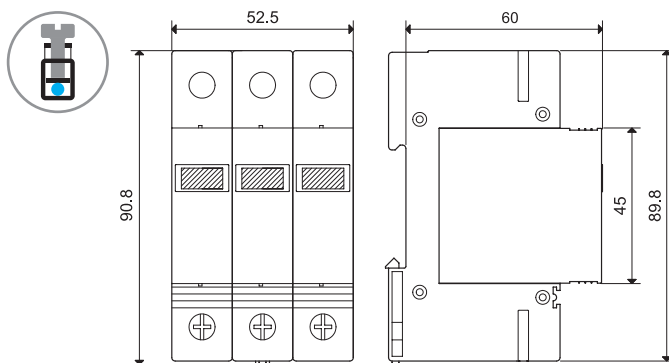

Type 7P.37.8.275.1003
Screw terminal

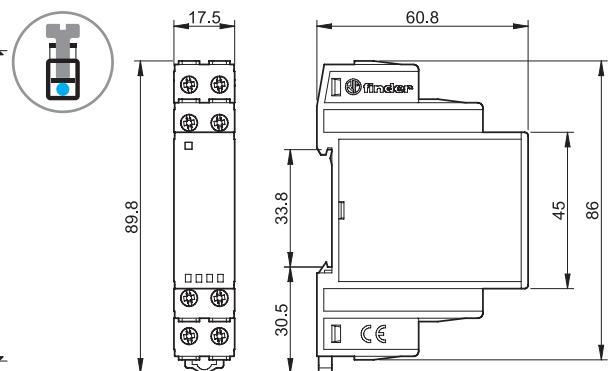

E

Outline drawings

Type 7P.68.9.060.0600

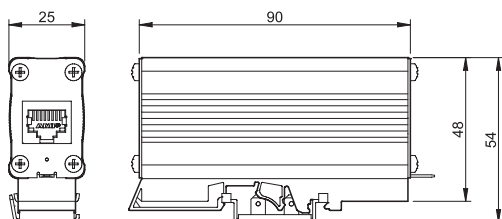

Type 7P.62.9.036.0005/7P.62.9.009.0485

Screw terminal

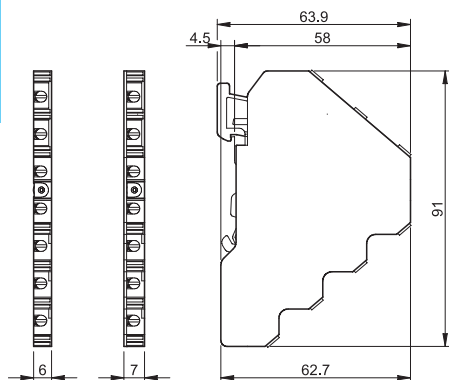

Type
7P.36.8.275.2003

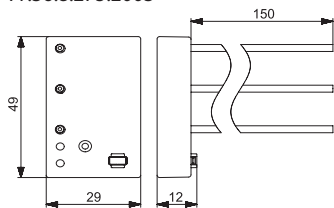

Type
7P.31.8.275.0005/7P.32.8.275.0005

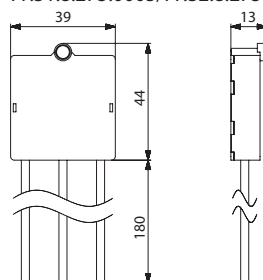

Type 7P.00
Replaceable module

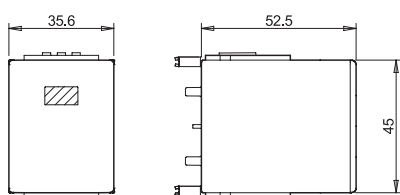

Type 7P.10/20
Replaceable module

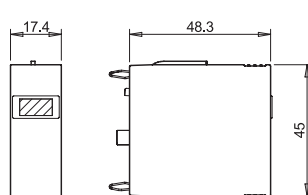

07P.01
Connector

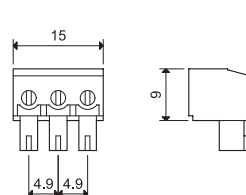

Installation example - SPD Type 1 + 2

TT-SINGLE PHASE SYSTEM - SPD UP-STREAM OF RCD

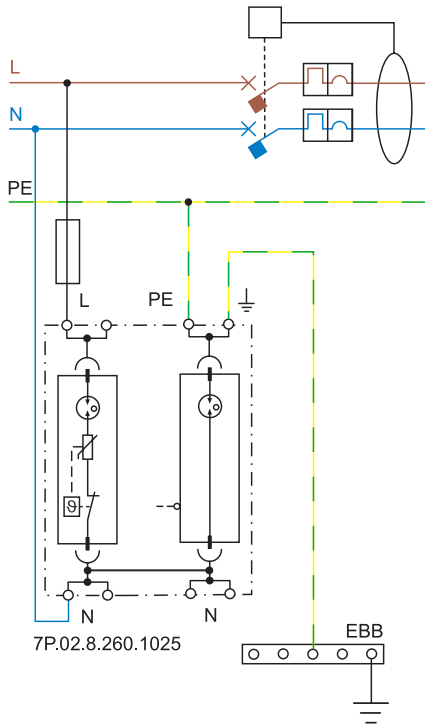

TT-THREE PHASE SYSTEM - SPD UP-STREAM OF RCD

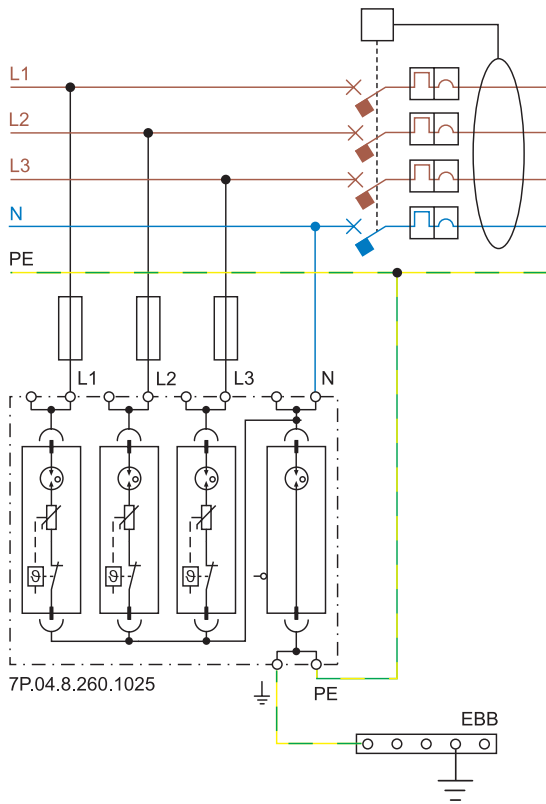

Wiring diagrams "V-shape" (fuse max = 125 A)

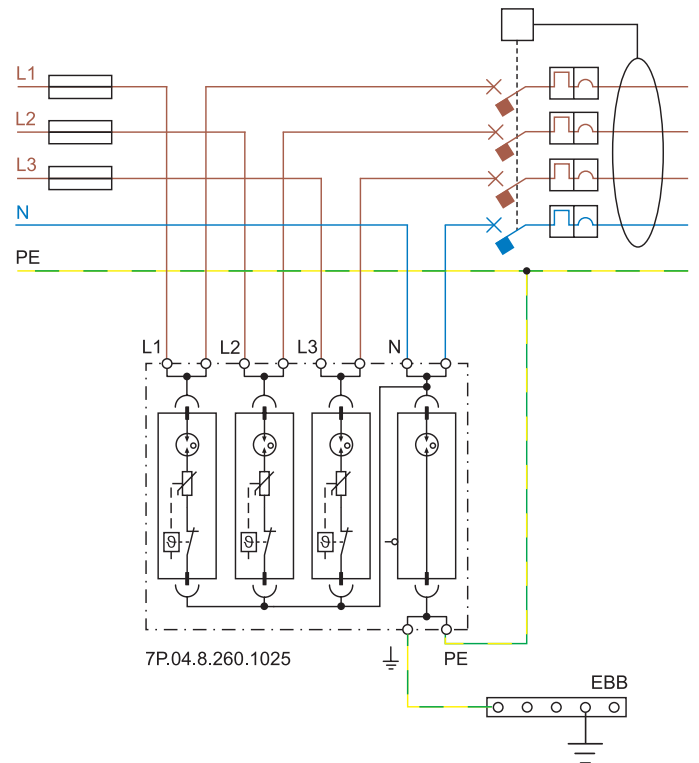

E

Installation example for SPD Type 1 + 2 and Type 2 - Single phase

TT-SINGLE PHASE SYSTEM - SPD UP-STREAM OF RCD

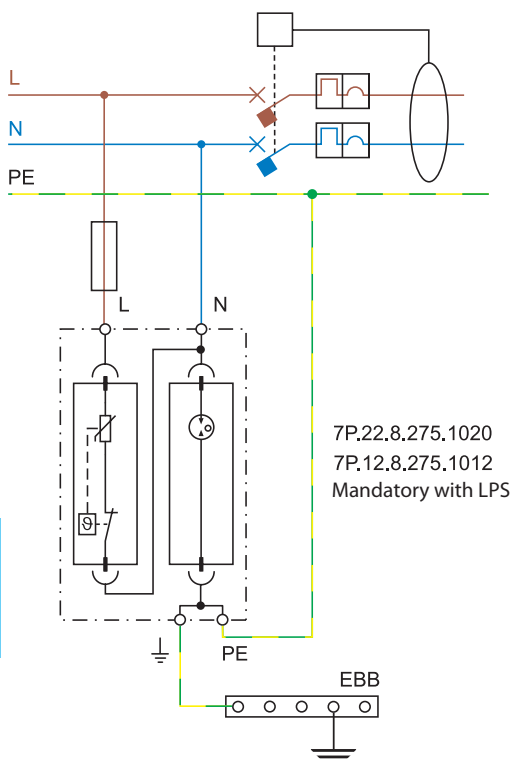

TT or TN-S SINGLE PHASE SYSTEM - SPD DOWN-STREAM OF RCD

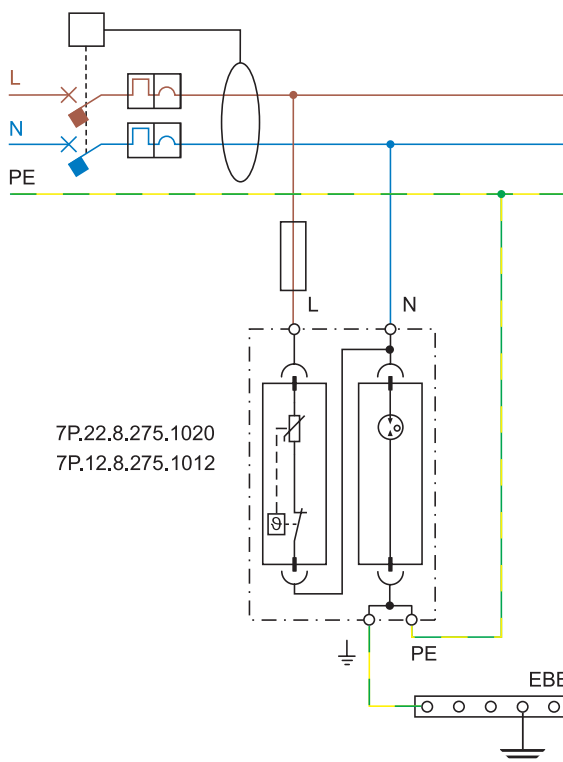

TN-S SINGLE PHASE SYSTEM - SPD DOWN-STREAM OF RCD

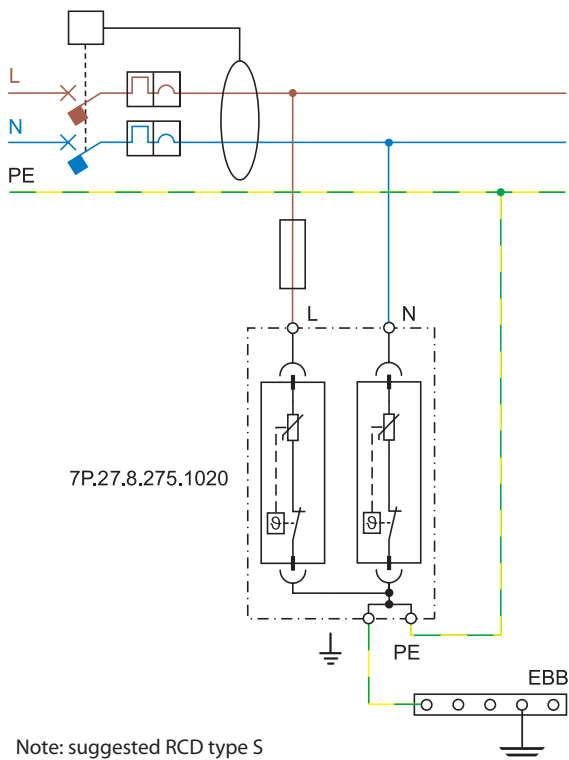

Installation example for SPD Type 3

TT or TN-S SINGLE PHASE SYSTEM - INCORPORATED IN SOCKET OUTLET

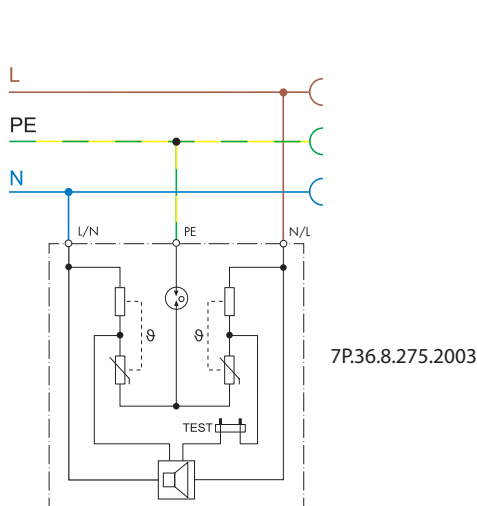

Installation example for SPD Type 1 + 2 and Type 2 - Three phase

TT-THREE PHASE SYSTEM - SPD UP-STREAM OF RCD

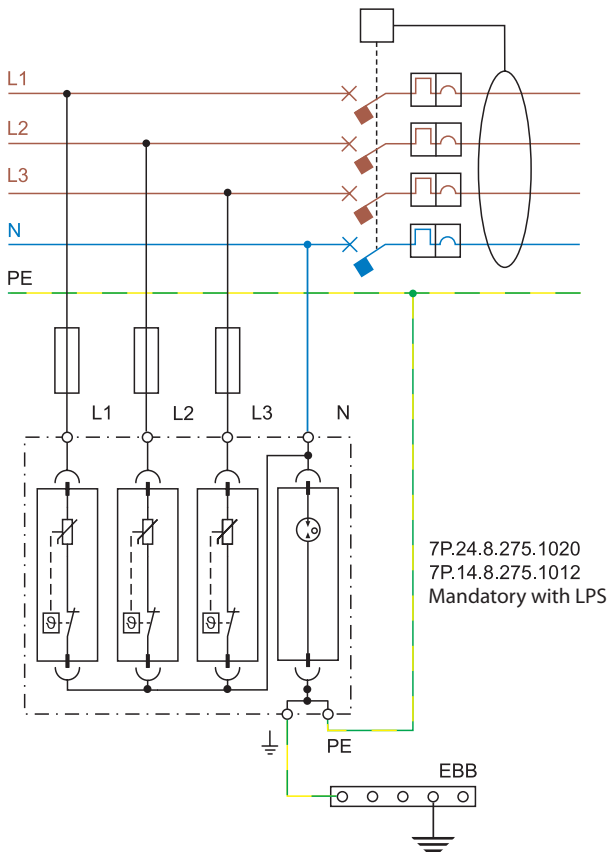

TT or TN-S THREE PHASE SYSTEM - SPD DOWN-STREAM OF RCD

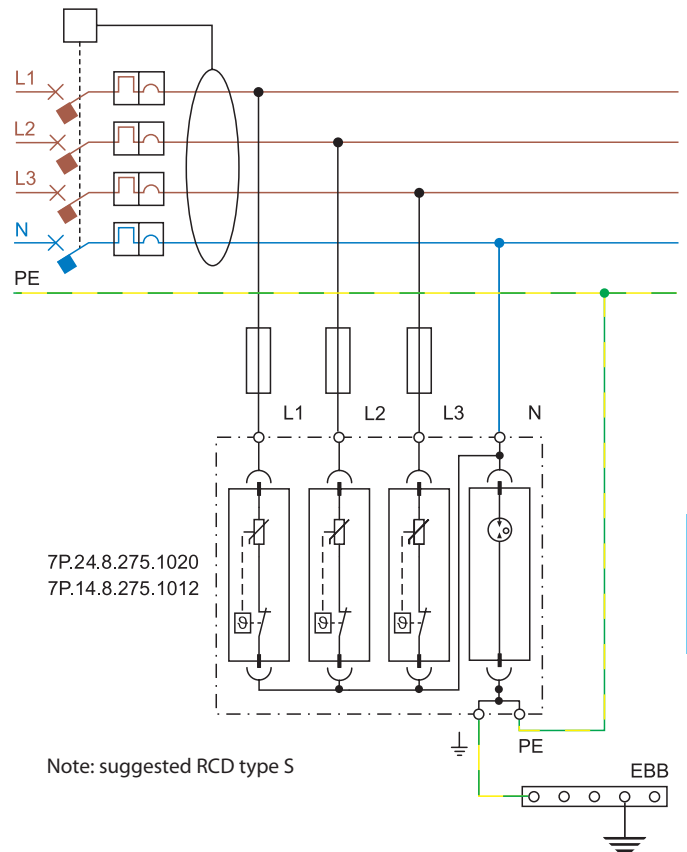

TN-S THREE PHASE SYSTEM - SPD DOWN-STREAM OF OVERCURRENT PROTECTION

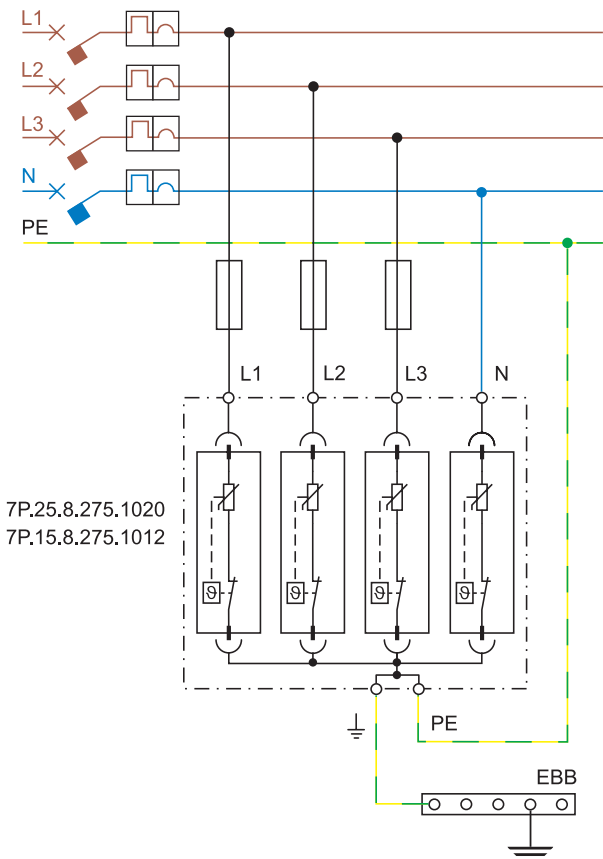

TN-C THREE PHASE SYSTEM - SPD UP-STREAM OF OVERCURRENT PROTECTION

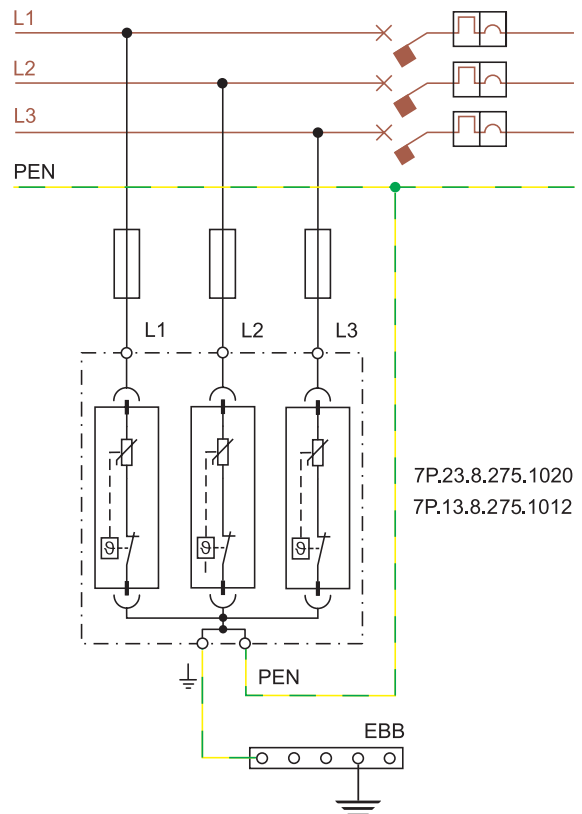

Installation example for SPD Type 3 - Single phase

TT or TN-S SINGLE PHASE SYSTEM - SPD DOWN-STREAM OF RCD
Serial connection

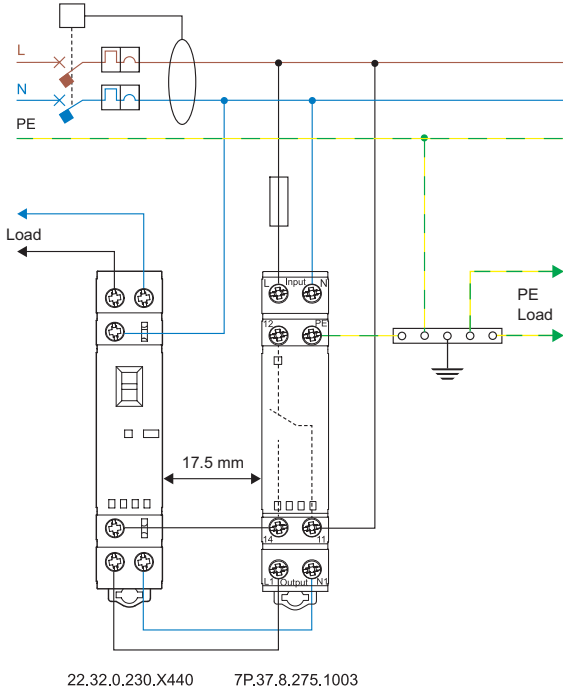

TT or TN-S SINGLE PHASE SYSTEM - SPD DOWN-STREAM OF RCD
Serial connection + BUS line

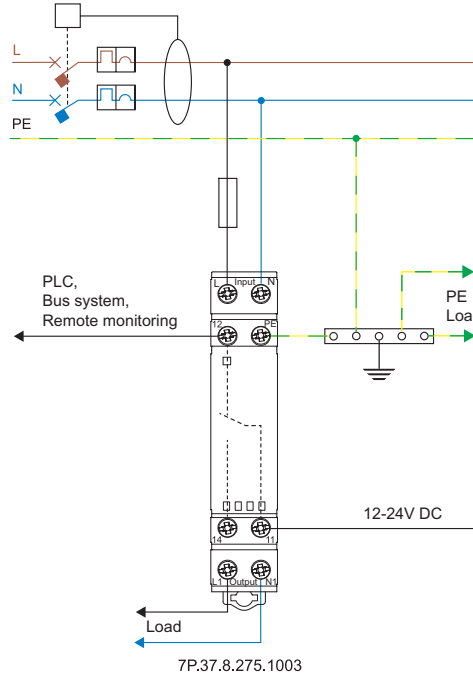

E

TT, TN-S SINGLE PHASE: parallel connection

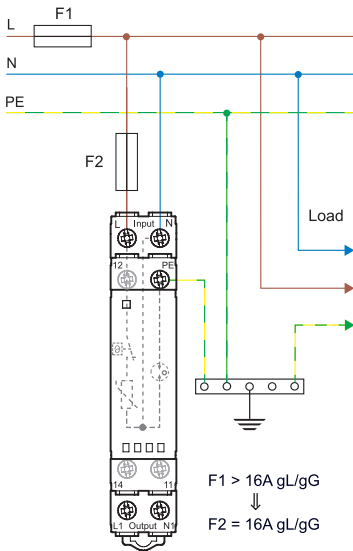

Function

Visual local LED signalling and remote signalling of varistor status

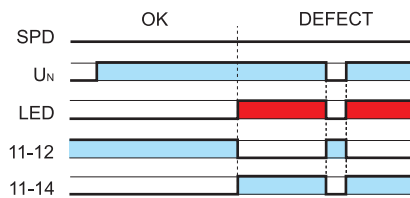

L7P Temperature/Current diagram for model 7P.37

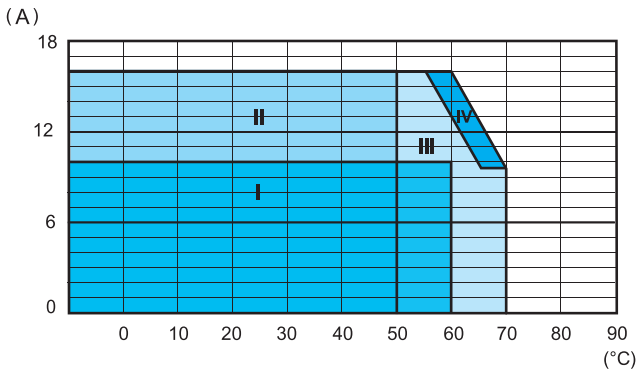

Zone I: SPD and other devices installed as a group (without gap)

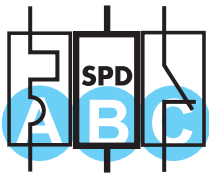

- A** MCB = B10A, C10A
- B** 7P.37.8.275.1003
- C** 22.32.0.xxx.x4x0

Zone II: SPD spaced, at least from one side, from components that generate heat during their operation (17.5 mm gap)

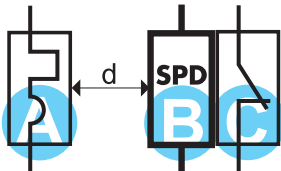

- A** MCB = B16A, C16A
- B** 7P.37.8.275.1003
- C** 22.32.0.xxx.x4x0
- d** 17.5 mm



- A** MCB = B16A, C16A
- B** 7P.37.8.275.1003

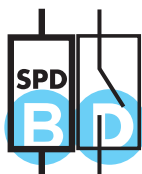

- B** 7P.37.8.275.1003
- D** 22.32.0.xxx.x3x0
22.32.0.xxx.x4x0

Zone III: SPD spaced, on both side, from components that generate heat during their operation (20 mm gap)

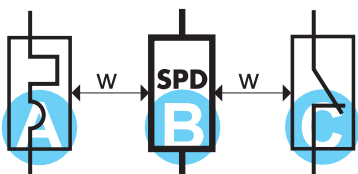

- A** MCB = B16A, C16A
- B** 7P.37.8.275.1003
- C** 22.32.0.xxx.x4x0
- w** 20 mm

Zone IV: SPD installed individually in free air (without significant influence from nearby components)



- B** 7P.37.8.275.1003

Installation examples - photovoltaic

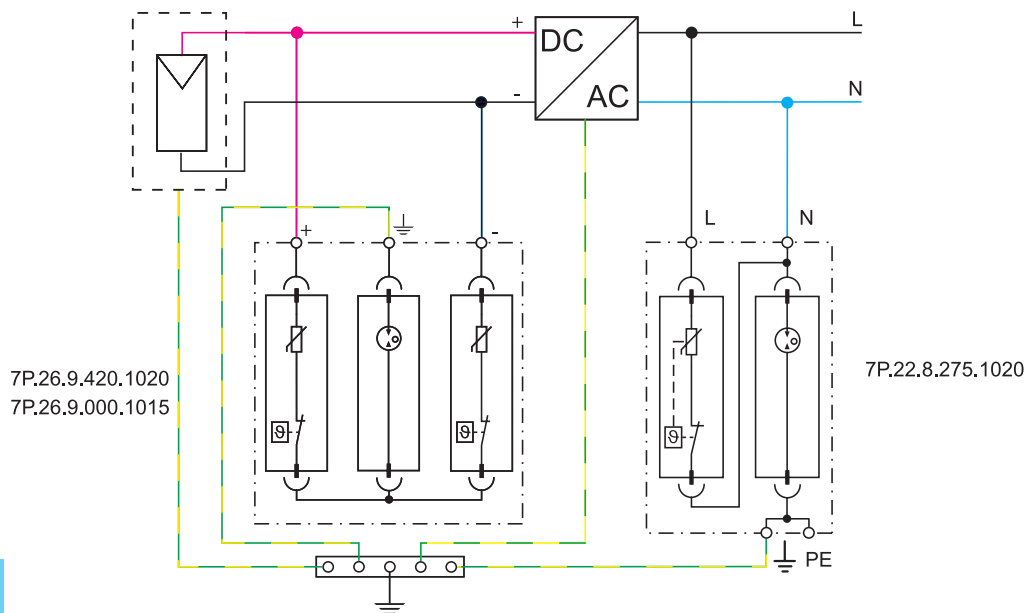

E

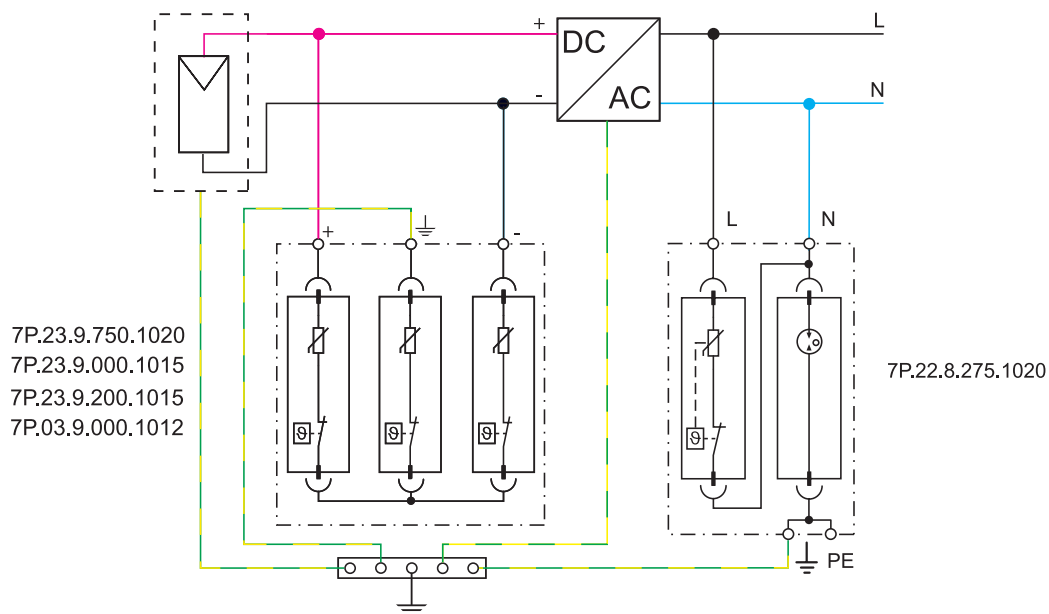

SURGE VOLTAGE PROTECTORS

Surge voltage protectors (such as Finder's Surge Protection Devices, SPD) are intended to be installed in electrical systems, to protect people and machines from surge voltages that can occur on the electrical supply line and which would otherwise have disastrous consequences. These surge voltages can be atmospheric (lightning) or can originate on the electrical system due to, for example: the opening and closing of large loads, short circuits, or the switching of large power factor correction capacitors. The SPD can be described as a switch that is in parallel with the electrical system's supply line - which it is protecting. At the nominal network voltage (e.g. 230 V) the SPD appears as an open switch, having a very high impedance (almost infinite). But, under an overvoltage condition its impedance rapidly falls to near 0 Ω. This effectively applies a short circuit across the supply lines and immediately "drains" the overvoltage to earth. In this way the supply line is protected wherever an SPD is installed. When the overvoltage has passed, the SPD impedance rises rapidly and resumes the state of an open switch again.

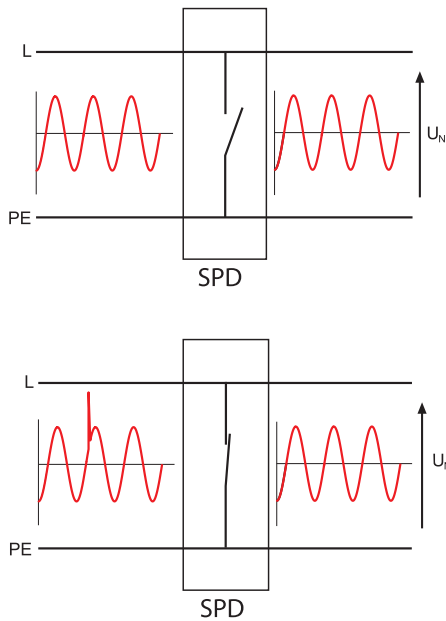

Figure 1: Ideal operation of an SPD

SPD technologies

Finder surge voltage protectors use either varistors or spark gaps.

Varistor: This can be considered as a variable resistance that at nominal voltage has a very high ohmic value. But the resistance rapidly falls to near zero as the voltage surges. In this way the varistor applies a near short circuit which clamps the surge voltage. The varistor is however subject to progressive degradation due to the small leakage current that occurs at the nominal voltage, and with the number of interventions. With every overvoltage that occurs the leakage current rises and accelerates the end of life for the device - which is ultimately indicated by the change from green to red in the signal-window.

Spark gap: This comprises two electrodes separated by air, or a gas. When a surge voltage occurs an electrical arc bridges the gap and a surge current flows to limit the surge voltage to a low and constant level. The arc extinguishes only when the surge current falls below about 10 ampere. The gas guarantees a constant level of breakdown voltage since the arc is struck in a protected environment; not exposed to pressure or humidity variations or impurities as would happen if it had occurred in air. There is however, a delay before the device arcs and the surge current is diverted, and this is dependent on the magnitude of the original voltage surge and on its rate of rise. Therefore, the voltage protection level can vary, although it is guaranteed to be less than U_p .

Component	Symbol	Leakage current	Energy dissipated	Response time	Voltage/Current characteristic
Ideal		0	High	Fast	
Spark gap		0	High	Medium	
Varistor		Very Low	Medium	Fast	

Figure 2: SPD component characteristics.

Installation (Overvoltage) categories

Choosing the SPD requires matching the Rated Impulse Voltage of the SPD with that of the equipment to be protected. This in turn relates to the Installation category (Overvoltage category). Installation categories are described within IEC 60664-1, which for a 230/400 V installation prescribes as follows:

- **Installation category I:** 1.5 kV for "particularly sensitive" equipment (e.g. electronic devices like PC or TV set);
- **Installation category II:** 2.5 kV for "user" equipment subject to "normal" impulse voltages (e.g. household electrical appliances, mobile items);
- **Installation category III:** 4 kV for equipment that are part of a fixed installation (e.g. switchboards, switches)
- **Installation category IV:** 6 kV for equipment installed at or near the origin of main incoming supply mains (e.g. energy meters).

Lightning Protection Zones and installation considerations

International standards refer to the various Lightning Protection Zones by the letters LPZ followed by an appropriate number.

- LPZ 0A: An external area, where a direct lightning strike is possible and where there is total exposure to the electromagnetic field induced by the lightning.
- LPZ 0B: An external area, but below a lightning conductor providing direct lightning strike protection. There remains total exposure to the electromagnetic field.
- LPZ 1: Area within a building – therefore protected from direct lightning strike. The electromagnetic field will be attenuated, depending on the degree of shielding. This zone has to be protected by SPD type 1 device(s) at its boundary with the LPZ 0A or 0B zone.
- LPZ 2: An area, typically a room, where the lightning current has been limited by preceding surge protectors. This zone has to be protected by SPD type 2 device(s) at its boundary with the LPZ 1 zone.
- LPZ 3: An area within a room where the lightning current has been limited by preceding surge protectors (typically the wiring after a socket or an area within a metal enclosure).

This zone has to be protected by SPD type 3 device(s) at its boundary with the LPZ 2 zone. On the following picture (Figure 3, representation is not binding) it is shown that the transition from a protection zone to the next is through the installation of SPD. SPD Type 1 must be connected upstream the system, at the point of delivery connection. As an alternative it is possible to use SPD Type 1+2. The grounding conductor must have a minimum section of 6 mm² for SPD Type 1, of 4 mm² for SPD Type 2, and 1.5 mm² for SPD Type 3 (If the building has an LPS, reference should be made to CEI 81-10/4 for the correct dimension of the cable).

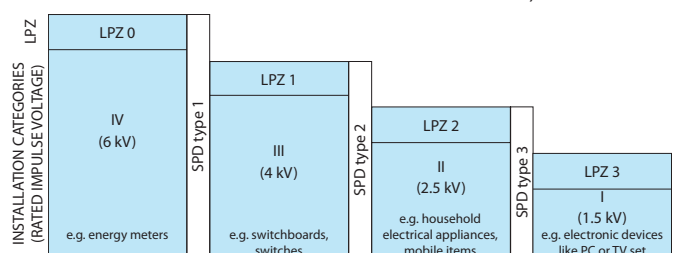

Figure 3: Typical relationship between Lightning Protection Zones, Installation Categories and SPD types

Rated values and marking common to all SPD

[U_c] Maximum continuous operating voltage: Under this voltage the SPD is guaranteed to appear as an "open switch". This voltage is normally at least equal to the nominal supply voltage (U_N) +10%. For the Finder SPD, U_c is specified as 275 V.

[U_p] Voltage protection level: This is the highest voltage level seen across the SPD during its intervention. For example, for Finder SPD Type 2, this means that a 4 kV overvoltage would be limited by the SPD to a maximum 1.2 kV. Consequently, electronic devices such as PC, TV, stereo, etc. are protected - as their own internal protection will handle overvoltages U_p to 1.5 kV.

To better understand this concept; imagine that the SPD is a switch in series a low resistance. In the case of an overvoltage the switch closes and all the current goes through the resistance. According to Ohm's law the voltage developed across the resistance will be this resistance x the current (V = R x I), and will be limited to < U_p.

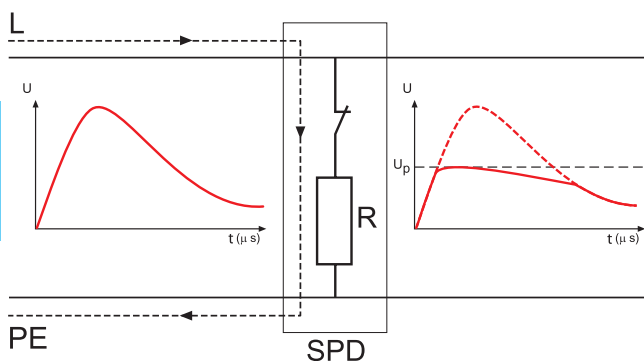

Figure 4: Overvoltage limiting

Short circuit proof: A further characteristic, not normally marked on the product but important for its correct installation, is the Short circuit proof at maximum overcurrent protection. This is the maximum short-circuit current that the SPD is able to withstand when it is installed with additional maximum overcurrent protection - such as a fuse rated in accordance with the value stated under the SPD specification. Consequently the maximum prospective short-circuit current of the system at the point of installation of the SPD must not exceed this value.

Rated values and marking of SPD Type 1

SPD Type 1 must be connected upstream the system, at the point of delivery of power energy. SPD protects building and people from the risk of direct lightning (fire and death) and are characterized by:

[I_{imp}10/350] Impulse current: I_{imp} corresponds to the peak value of a 10/350 μs current impulse waveform. This waveform represents a direct lightning strike and is used in tests to prove the performance of SPD type 1 devices.

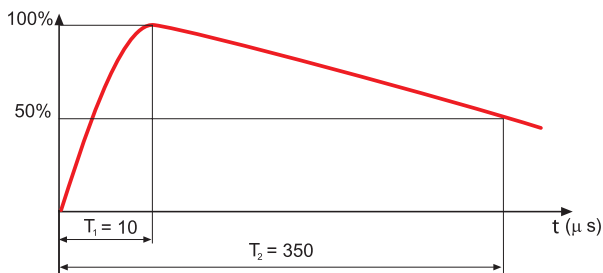

Figure 5: 10/350 μs current waveform

Comparison of the waveforms in figures 5 and 6 shows the much higher energy content controlled by the type 1 SPD.

[I_n8/20] Nominal discharge current: The peak current (and waveform shape) through the SPD under conditions prescribed by EN 62305 to represent the surge current as a consequence of a lightning strike to the electric supply line.

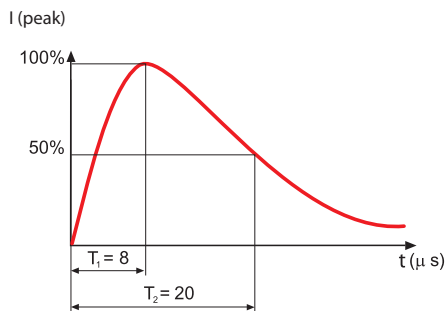

Figure 6: 8/20 μs current waveform

Rated values and marking of SPD Type 2

SPD Type 2 devices are designed to remove all the overvoltage from supply circuits that are not likely to be directly hit by lightning. SPD Type 2 are connected downstream SPD Type 1 or SPD Type 1+2, (minimum distance 1 m) and they protect machine and tools connected to the ground and reduce the risk of economic loss.

SPD Type 2 are characterized by:

[I_n8/20] Nominal discharge current: The peak current (and waveform shape) through the SPD under conditions prescribed by EN 62305 to represent the surge current as a consequence of a lightning strike to the electric supply line.

[I_{max}8/20] Maximum discharge current: Peak value of the highest current of a 8/20 μs waveform that an SPD can discharge at least once without breaking.

Rated values and marking of SPD Type 3

SPD type 3 devices are used to protect the end user from overvoltage. They may be installed in supply networks where SDP types 1 and/or 2 already exist. They can be installed in fixed or mobile sockets and have the following characteristic parameters.

U_{oc}: test voltage. This is the peak value of the no load voltage of the combined test-generator; this has a waveform of 1.2/50 μs (figure 7) and can supply at the same time current with waveform 8/20 μs (figure 6).

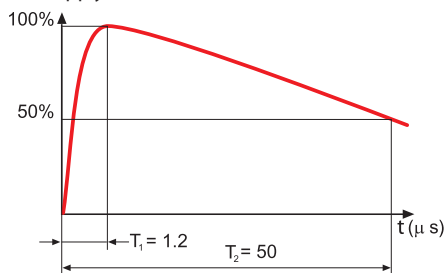
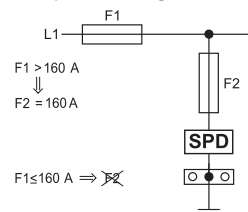

Figure 7: 1.2/50 μs voltage waveform

Suggestion for the connection

The correct connection of SPD requires a shortest as possible connection to the local equipotential bar, to which are connected PE cables of the equipment to be protected. From the local equipotential bar there is a connection to the EBB. The phase wiring remains appropriate to the load.



Short-circuit protection for the SPD is provided by the overcurrent protective devices (fuses type gL/gG) recommended.

If the overcurrent protective devices F1 (which are part of the installation) have a rating smaller than or equal to the maximum recommended rating for the overcurrent protective devices for the SPD, then F2 (back up fuse), can be omitted.

7P.0X:

If $F1 > 250 \text{ A}$, then $F2 = 250 \text{ A}$

If $F1 \leq 250 \text{ A}$, F2 can be omitted

7P.1X, 7P.2X:

If $F1 > 160 \text{ A}$, then $F2 = 160 \text{ A}$

If $F1 \leq 160 \text{ A}$, F2 can be omitted

Coordination of SPD

Optimal protection from surges requires cascaded coordinated SPDs. Coordination has the purpose of splitting the energy associated with voltage across the SPDs and it is achieved by introducing an impedance between the SPDs, or alternatively, by connecting them using wires having the minimum length indicated in the figures below, in order to use the cable's own impedance.

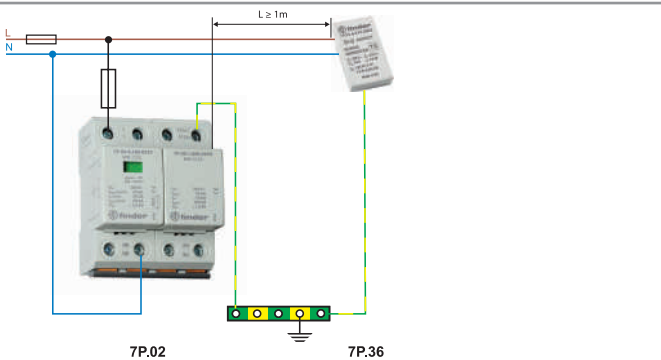
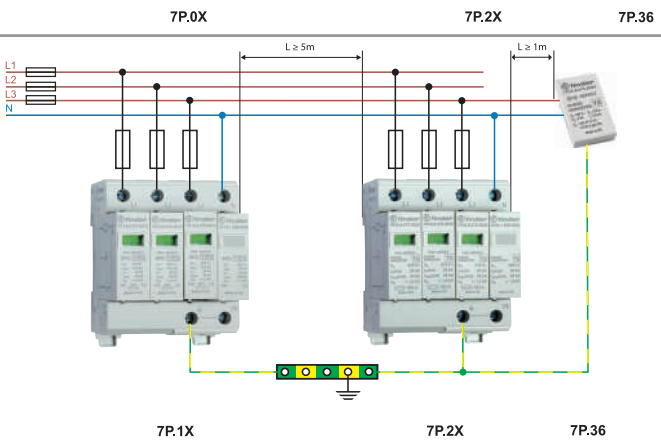
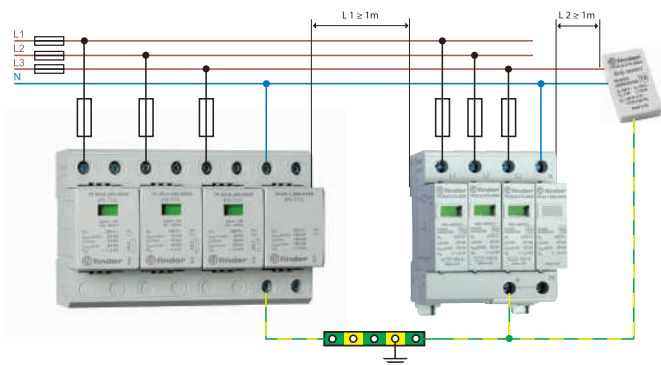

V-shape connection

Using a V-shaped connection eliminates transferring downstream the inductive voltage generated by the surge current in the connecting wire to the SPD. This increases the protection to the system and equipment downstream. A limitation of this connection is that the nominal current for the downstream system is limited to 125 A, which is the maximum current permitted through the double SPD terminals.

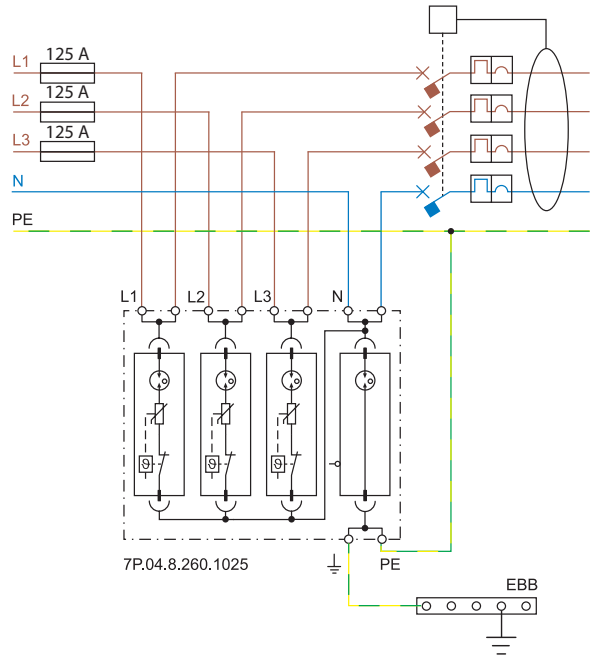

For systems where the rated current is greater than 125 A, it is necessary to connect the SPD in parallel with the equipment (E/I).

Connecting cable

Depending on the type of connection, serial (V-shape) or parallel (T-shape), ensure that both the maximum cable lengths and minimum cross section of the connecting wires are respected in accordance with the information below (IEC 60634-5-534):

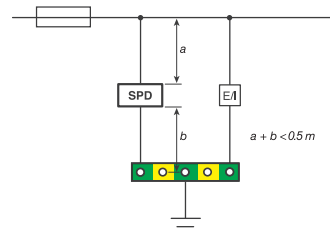
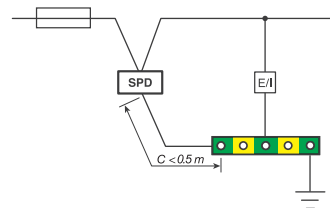

The section of the connecting wires (copper) must not be less than:
 SPD Type 1: 16 mm² if it is subject to discharge a significant lightning current, 6 mm² otherwise

SPD Type 2: 6 mm²

SPD Type 3: 1.5 mm²

PROTECTING PHOTOVOLTAIC (PV) SYSTEMS AGAINST LIGHTNING

Installation characteristics

[U_{OCSTC}] PV voltage: Open circuit voltage, measured under standardized test conditions, of the PV module, panel, array, or the DC side of the photovoltaic inverter. prEN 50539-12.

[I_{SCPV}] Short-circuit current: Short-circuit current, measured under standardized test conditions, of the PV module, panel, array, or photovoltaic inverter. prEN 50539-12.

[U_{CPV}] SPD Maximum continuous operating voltage: Must be equal or greater than to 1.2 times U_{OCSTC} in all conditions of radiation and temperature. prEN 50539-11, prEN 50539-12.

[I_{SCPV}]: Maximum prospective short-circuit current from the power system for which the SPD, in conjunction with the disconnectors specified, is rated. EN 50539-11.

System installation

Photovoltaic systems are generally located external to a building and can be subjected to the direct or indirect effects of lightning.

Whilst the installation of photovoltaic panels on the roof does not, in itself, increase the risk of direct lightning, the only practical way to protect against the effects of a direct lightning strike would be the use of a lightning protection system (LPS).

The indirect effects of lightning can however, be mitigated by the appropriate use of Surge Protection Devices (SPD). These indirect effects occur when lightning strikes in proximity to the structure and where magnetic induction creates an overvoltage in the conductors – a danger to both people and equipment. In particular, the DC cables of a PV system would be exposed to the high conducted and radiated disturbances caused as a result of the lightning currents. In addition, overvoltages in PV systems are not only of atmospheric origin. It is also necessary to consider overvoltages due to switching on electrical networks connected to them. These overvoltages can also damage both the inverter and the PV panels, and this explains the need to protect the inverter on both DC and AC sides.

Photovoltaic system on a building without a lightning protection system (LPS)

As an example, Figure 10 represents a simplified photovoltaic system placed on a building without lightning rod. In such a system, the protection against lightning must be considered at the following points of installation:

- DC input of the inverter
- AC output of the inverter
- Low voltage supply network

At the DC input to the inverter SPDs specific for photovoltaic systems must be installed, according to the PV system voltage. At the inverter AC output, type 2 surge arresters must be installed suitable for the type of system. At the point of connection to the LV supply network, install type 2 surge arresters suitable to the type of system (TT, TN). In more complex systems, it might be necessary to introduce additional SPDs. DC side: if the distance between the inverter and PV modules exceeds 10 m, it is necessary to replicate and install the SPD as close as possible to the PV modules.

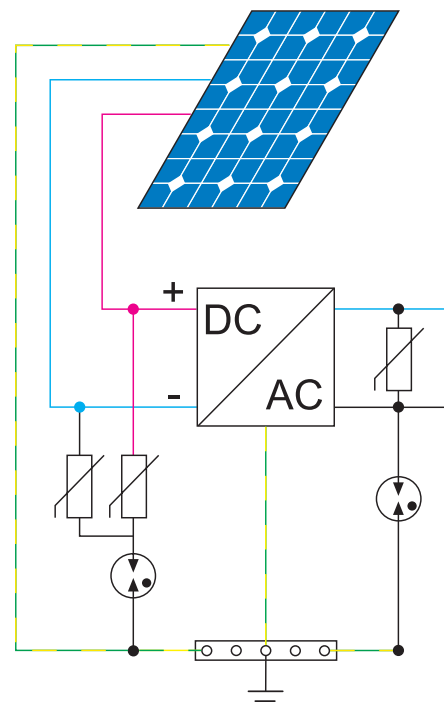

Figure 10: Example of a photovoltaic system located on a building without LPS, protected on the DC side by an SPD with $U_{OCSTC} = 420$ V, and on the AC side by a 7P.22, specific for TT systems.

Photovoltaic system on a building with a lightning protection system (LPS)

Where an LPS exists it is good practice to install the photovoltaic panels in the area protected by the lightning rod.

In addition it is necessary to realize a good equipotential bonding system, which must be positioned as close as possible to the entry point of LV supply into the structure. The LPS, the SPD and all metal parts have to be connected to this equipotential system.

SPD protection on the DC depends on the safety distance (referred in EN 50539-12:12-2012).

Note that under EN 62305 installation of a Type 1 SPD is mandatory at the point of delivery of the AC electricity supply, whether or not the building has LPS (with or without solar panels).

SPD fuse protection

Conforming to prEN 50539-11:2010, Finder SPDs are equipped with a thermal disconnecter able to safely disconnect a worn or damaged varistor up to a value of short-circuit current equal to the short-circuit current withstand value (I_{scpv}), as specified in the technical data.

Ensure that the PV short circuit current $I_{sc} < I_{scpv}$.

Ensure that the PV short circuit current $I_{sc} < I_{scpv}$ or increase the number of the strings.

Insulation distances and wiring

To conform with prEN 50539-11 insulation distances and minimum wiring cross section must be respected.

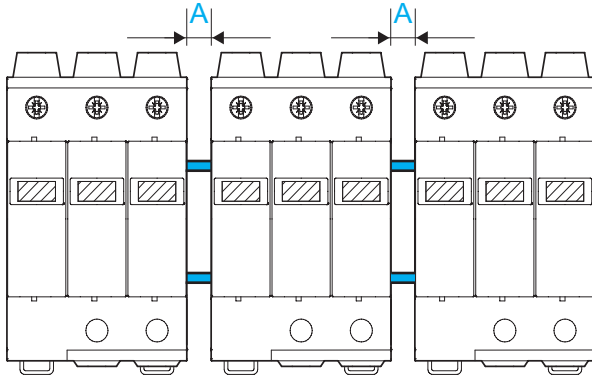

Insulation distances		Minimum Wiring [mm ²]	
$U_{CPV}(SPD) \geq 1.2 \times U_{OCSTC}$	A [mm]	+/- Poles	Ground
750 V DC	5	4	6
1,000 V DC	5	4	6
1,200 V DC	7	4	6

E



finder[®]
SWITCH TO THE FUTURE

Switch mode power supplies

78
SERIES



Building automation



Elevators and lifts



Automation for blinds, grilles and shutters



Hoists and cranes



Panels for electrical distribution



Pump Control



12 W Low profile Modular DC Power Supplies for electrical cabinets

Type 78.12....2400

- Output 24 V DC, 12 W
- 17.5 mm (1 module) x 61 mm deep

Type 78.12....1200

- Output 12 V DC, 12 W
- 17.5 mm (1 module) x 61 mm deep

- Low (< 0.4 W) stand-by power consumption
- Thermal protection: internal, with V_{out} shutdown - power OFF to reset
- Short circuit protection: Hiccup (auto-recovery) mode
- Overvoltage protection: Varistor
- Flyback topology
- Compliant with EN 60950-1 and EN 61204-3
- Parallel working for automatic redundancy - with OR diodes
- Dual Polarity and Series connection permissible
- 35 mm rail (EN 60715) mount

Screw terminal



For outline drawing see page 21

Output specification

Output current (-20...+40 °C, 230 V AC input)	A	0.63	1.25
Rated current I_N (50 °C, full input operating range)	A	0.50	1
Rated voltage	V	24	12
Rated power	W	12	12
Output power (-20...+40 °C, 230 V AC input)	W	15	15
Peak current capability for 3 ms*	A	2	3
Output voltage adjust	V	—	—
Voltage variation (from no-load to full-load)		< 1%	< 1%
Voltage ripple @ full load**	mV	< 200	< 200
Hold-up time @ full load: with 100 V AC input	ms	> 10	> 10
	with 260 V AC input	ms	> 90

Input specification

Nominal voltage (U_N)	V AC (50/60 Hz)	110...240	110...240
	V DC (not polarized)	220	220
Operating range	V AC (50/60 Hz)	100...265***	100...265***
	V DC	140...370	140...370
Max power consumption (@ 100 V AC, 50 Hz)	VA	28.2	32
	W	14.2	17.2
Stand-by power consumption	W	< 0.4	< 0.4
Power factor		0.50	0.53
Max current consumption (@ 88 V AC)	A	0.25	0.30
Max. inrush current (peak @ 265 V) for 3 ms	A	10	10
Replaceable input fuse		—	—

Technical data

Efficiency (@ 230 V AC)	%	85	87
MTTF	h	> 400 · 10 ³	> 400 · 10 ³
Start-up delay	s	< 1	< 1
Dielectric strength between input/output	V AC	2500	2500
Dielectric strength between input/PE	V AC	—	—
Ambient temperature range****	°C	-20...+60	-20...+60
Protection category		IP 20	IP 20

Approvals (according to type)



78.12....2400



• 24 V DC, 12 W output

78.12....1200



• 12 V DC, 12 W output

* (see diagrams P78)

** peak to peak, 100 Hz component, with 100 V AC input

*** 88...100 V AC with output current limited to 80% I_N

**** (see derating diagrams L78)

25 W Low profile Modular DC Power Supplies for electrical cabinets
Type 78.25....2400

- Output 24 V DC, 25 W
- 35 mm (2-module) x 61 mm deep

Type 78.25....1200

- Output 12 V DC, 25 W
- 35 mm (2-module) x 61 mm deep
- Low (< 0.4 W) stand-by power consumption
- Thermal protection: internal, with V_{out} shutdown - power OFF to reset
- Short circuit protection: Hiccup (auto-recovery) mode
- Overvoltage protection: Varistor
- Flyback topology
- Compliant with EN 60950-1 and EN 61204-3
- Parallel working for automatic redundancy - with OR diodes
- Dual Polarity and Series connection permissible
- 35 mm rail (EN 60715) mount

Screw terminal

NEW 78.25....2400

- 24 V DC, 25 W output

NEW 78.25....1200

- 12 V DC, 25 W output

* (see diagrams P78)

** peak to peak, 100 Hz component, with 100 V AC input

*** 88...100 V AC with output current limited to 80% I_N

**** (see derating diagrams L78)

For outline drawing see page 19

Output specification

Output current (-20...+40 °C, 230 V AC input)	A	1	2.1
Rated current I_N (50 °C, full input operating range)	A	0.75	1
Rated voltage	V	24	12
Rated power	W	25	25
Output power (-20...+40 °C, 230 V AC input)	W	25	25
Peak current capability for 3 ms*	A	3	4
Output voltage adjust	V DC	—	—
Voltage variation (from no-load to full-load)		< 1%	< 1%
Voltage ripple @ full load**	mV	< 200	< 200
Hold-up time @ full load:	with 100 V AC input ms	>40	> 40
	with 260 V AC input ms	>100	> 100

Input specification

Nominal voltage (U_N)	V AC (50/60 Hz)	110...240	110...240
	V DC (not polarized)	220	220
Operating range	V AC (50/60 Hz)	100...265***	110...265***
	V DC	140...370	140...370
Max power consumption (@ 100 V AC, 50 Hz)	VA	56.4	56
	W	27.5	27.3
Stand-by power consumption	W	≤ 0.5	≤ 0.30
Power factor		0.50	0.50
Max current consumption (@ 88 V AC)	A	0.43	0.43
Max. inrush current (peak @ 265 V) for 3 ms	A	20	20
Replaceable input fuse		—	—

Technical data

Efficiency (@ 230 V AC)	%	89	89
MTTF	h	> 400 · 10 ³	> 400 · 10 ³
Start-up delay	s	< 1	< 1
Dielectric strength between input/output	V AC	2500	2500
Dielectric strength between input/PE	V AC	—	—
Ambient temperature range****	°C	-20...+60	-20...+60
Protection category		IP 20	IP 20

Approvals (according to type)

CE EAC

36 W, 60 W and 50 W High efficiency, low profile Modular DC Power Supplies for electrical cabinets

Type 78.36

- Output 24 V DC, 36 W
- Input fuse: Easily replaceable plus spare
- 70 mm (4-module) wide x 61 mm deep

Type 78.60

- Output 24 V DC, 60 W

Type 78.50

- Output 12 V DC, 50 W

- High efficiency (up to 91%)
- Low (< 0.4 W) stand-by power consumption
- Thermal protection: internal, with V_{out} shutdown - power OFF to reset
- Short circuit protection: Hiccup (auto-recovery) mode
- Input fuse: Easily replaceable plus spare
- Overvoltage protection: Varistor
- Flyback topology
- ZVS (Zero-voltage-switching), quasi-resonant mode switching
- Compliant with EN 60950-1 and EN 61204-3
- Parallel working for automatic redundancy - with OR diodes
- Dual Polarity and Series connection permissible
- Small dimensions: 70 mm (4-modules) wide, 61 mm deep
- 35 mm rail (EN 60715) mount

Screw terminal



For outline drawing see page 21

78.36



- 24 V DC, 36 W output

78.60



- 24 V DC, 60 W output
- Output adjustable between 24-28 V
- ZVS technology

78.50



- 12 V DC, 50 W output
- Output adjustable between 12-15 V
- ZVS technology

Replaceable fuse + spare



- * (see diagrams P78)
- ** peak to peak, 100 Hz component, with 100 V AC input
- *** 88...100 V AC with output current limited to 80% I_N
- **** (see derating diagrams L78)

Output specification

Output current (-20...+40 °C, 230 V AC input)	A	1.7	2.8	4.6
Rated current I _N				
(50 °C, input (100...265)V AC - (140...370)V DC)	A	1.5	2.5	4.2
Rated voltage	V	24	24	12
Rated power	W	36	60	50
Output power (-20...+40 °C, 230 V AC input)	W	40	68	55
Peak current capability for 3 ms*	A	8	10	12
Output voltage adjust	V	—	24...28	12...15
Voltage variation (from no-load to full-load)		< 1%	< 1%	< 1%
Voltage ripple @ full load**	mV	< 200	< 200	< 200
Hold-up time @ full load: with 100 V AC input	ms	> 20	> 20	> 30
with 260 V AC input	ms	> 100	> 130	> 150

Input specification

Nominal voltage (U _N)	V AC (50/60 Hz)	110...240	110...240	110...240
	V DC (not polarized)	220	220	220
Operating range	V AC (50/60 Hz)	100...265****	88...265	88...265
	V DC	140...370	140...370	140...370
Max power consumption	VA	57.5	90	89
(@ 100 V AC, 50 Hz)	W	43	67.5	58.3
Stand-by power consumption	W	< 0.4	< 0.4	< 0.4
Power factor		0.74	0.75	0.65
Max current consumption (@ 88 V AC)	A	0.6	0.9	0.85
Max. inrush current (peak @ 265 V) for 3 ms	A	12	30	30
Replaceable input fuse		1 A - T	1.6 A - T	1.6 A - T

Technical data

Efficiency (@ 230 V AC)	%	86	91	90
MTTF	h	> 600 · 10 ³	> 500 · 10 ³	> 400 · 10 ³
Start-up delay	s	< 1	< 1	< 1
Dielectric strength between input/output	V AC	3000	3000	3000
Dielectric strength between input/PE	V AC	—	1500	1500
Ambient temperature range****	°C	-20...+70	-20...+70	-20...+70
Protection category		IP 20	IP 20	IP 20

Approvals (according to type)



60 W and 50 W High efficiency, low profile Modular DC Power Supplies for electrical cabinets
Fold-Back overload characteristics for Battery charging applications and parallel working for increased load current
Type 78.61

- Output 24 V DC, 60 W

Type 78.51

- Output 12 V DC, 50 W
- High efficiency (up to 91%)
- Low (< 0.4 W) stand-by power consumption
- Thermal protection: internal, with V_{out} shutdown - power OFF to reset
- Short circuit protection: Hiccup (auto-recovery) mode
- Overload protection: Fold-back mode
- Input fuse: Easily replaceable plus spare
- Overvoltage protection: Varistor
- Flyback topology
- ZVS (Zero-voltage-switching), quasi-resonant mode switching
- Compliant with EN 60950-1 and EN 61204-3
- Parallel working for increased load current (with OR diodes)
- Dual Polarity and Series connection permissible
- Small dimensions: 70 mm (4-modules) wide, 60 mm deep
- 35 mm rail (EN 60715) mount

Screw terminal



For outline drawing see page 21

Output specification

Output current (-20...+40 °C, 230 V AC input)	A	2.6	4.6
Rated current I_N			
(50 °C, input (100...265)V AC - (140...370)V DC)	A	2.5	4.2
Rated voltage	V	24	12
Rated power	W	60	50
Output power (-20...+40 °C, 230 V AC input)	W	68	55
Peak current capability for 3 ms*	A	8	12
Output voltage adjust	V	24...28	12...15
Voltage variation (from no-load to full-load)		< 1%	< 1%
Voltage ripple @ full load**	mV	< 200	< 200
Hold-up time @ full load: with 100 V AC input ms		> 20	> 30
with 260 V AC input ms		> 130	> 150

Input specification

Nominal voltage (U_N)	V AC (50/60 Hz)	110...240	110...240
	V DC (not polarized)	220	220
Operating range	V AC (50/60 Hz)	88...265	88...265
	V DC	140...370	140...370
Max power consumption (@ 100 V AC, 50 Hz)	VA	90	89
	W	67.5	58.3
Stand-by power consumption	W	< 0.4	< 0.4
Power factor		0.75	0.65
Max current consumption (@ 88 V AC)	A	0.9	0.85
Max. inrush current (peak @ 265 V) for 3 ms	A	30	30
Replaceable input fuse		1.6 A - T	1.6 A - T

Technical data

Efficiency (@ 230 V AC)	%	91	90
MTTF	h	> 500 · 10 ³	> 400 · 10 ³
Start-up delay	s	< 1	< 1
Dielectric strength between input/output	V AC	3000	3000
Dielectric strength between input/PE	V AC	1500	1500
Ambient temperature range***	°C	-20...+70	-20...+70
Protection category		IP 20	IP 20

Approvals (according to type)

NEW 78.61

- 24 V DC, 60 W output
- Output adjustable between 24-28 V
- ZVS technology
- Suitable for battery charging

NEW 78.51

- 12 V DC, 50 W output
- Output adjustable between 12-15 V
- ZVS technology
- Suitable for battery charging

Replaceable fuse + spare



* (see diagrams P78)

** peak to peak, 100 Hz component, with 100 V AC input

*** (see derating diagrams L78)

 suitable for battery charging (see details page 15)

**Industrial Switch Mode DC Power Supplies:
110 W to 130 W**

Type 78.1B

- Output 24 V DC, 110 W, compact size
- Secure electrical separation (SELV according to EN 60950)

Type 78.1D

- Output 24 V DC, 130 W
- Double stage active Power Factor Correction
- Fold-Back overload characteristics for Battery charging applications and parallel working for increased load current (78.1D)
- High efficiency (up to 93%)
- Low stand-by power consumption (down to 1 W)
- LLC (78.1B) or forward topology (78.1D)
- Thermal protection: internal with pre-alert alarm via LED and auxiliary contact, and with V_{out} safety shutdown - power OFF to reset (78.1D)
- Overload indication: Pre-alert alarm via LED and auxiliary contact indication (78.1D)
- Boost current: Without time limit, with LED and auxiliary contact indication (78.1D)
- Overload protection: Fold-back mode (78.1D)
- Short circuit protection: Hiccup (auto-recovery) mode
- Input fuse: Easily replaceable plus spare
- Overvoltage protection: Varistor
- Compliant with EN 60950-1 and 61204-3
- Parallel working for increased load current (with OR diodes)
- Dual Polarity and Series connection permissible
- 35 mm rail (EN 60715) mount

For outline drawing see page 21

Output specification

Output current (-20...+40 °C, 230 V AC input)	A	5.0	5.4
Rated current I_N (50 °C, full input operating range)	A	4.5****	5.4
Rated voltage	V	24	24
Rated power	W	110	130
Output power (-20...+40 °C, 230 V AC input)	W	120	130
Peak current capability for 5 ms*	A	10	10
Output voltage adjust	V DC	24...28	24...28
Voltage variation (from no-load to full-load)		< 3%	< 1%
Voltage ripple @ full load**	mV	< 300	< 100
Hold-up time @ full load:	with 110 V AC input ms	>20	> 20
	with 260 V AC input ms	>90	> 20

Input specification

Nominal voltage (U_N)	V AC (50/60 Hz)	120...240	110...240
	V DC	220	110...240
Operating range	V AC (50/60 Hz)	100...265	88...265
	V DC	140...275 (non-polarized)	95...275 (non-polarized)
Drop out DC Voltage	V	110	80
Max power consumption	VA	268 (@50 Hz)	145 (@ 50 Hz)
	W	133 (@50 Hz)	145 (@ 50 Hz)
Stand-by power consumption	W	< 1.0	< 3.3
Power factor		0.5	0.998
Max current consumption	A	1.75 (@115 V AC)	1.6 (@ 88 V AC)
Max. inrush current (peak @ 265 V) for 3 ms	A	12	12
Replaceable input fuse		3.15 A - T	2.5 A - T

Technical data

Efficiency (@ 230 V AC)	%	93	89
MTTF	h	> 500 · 10 ³	> 400 · 10 ³
Start-up delay	s	< 1	< 1
Dielectric strength between input/output	V AC	2500 (SELV)	2500
Dielectric strength between input/PE	V AC	1500	1500
Ambient temperature range***	°C	-20...+70	-20...+70
Protection category		IP 20	IP 20

Approvals (according to type)

NEW 78.1B



- 24 V DC, 110 W output
- Output adjustable between 24-28 V
- Compact size, low stand-by consumption

78.1D



- 24 V DC, 130 W output
- Output adjustable between 24-28 V
- Double stage with active PFC (Power Factor Correction)

Replaceable fuse + spare



Thermal protection with LED indication



(depending on type)

Auxiliary contact signalling



* (see diagrams P78)

** peak to peak, 100 Hz component, with 110 V AC input

*** (see derating diagrams L78)

**** @ 40°C

suitable for battery charging (see details page 15)

**Industrial Switch Mode DC Power Supply:
240 W****Overload characteristics support parallel
working for increased load current****Type 78.2E**

- Output 24 V DC, 240 W
- Double stage active Power Factor Correction
- High efficiency (up to 93%)
- Low stand-by power consumption
- Forward topology
- Thermal protection: internal with pre-alert alarm via LED and auxiliary contact, and with V_{out} safety shutdown - power OFF to reset
- Overload indication: Pre-alert alarm via LED and auxiliary contact indication
- Boost current: Without time limit, with LED and auxiliary contact indication
- Overload up to 20 A
- Short circuit protection: Hiccup (auto-recovery) mode
- Input fuse: Easily replaceable plus spare
- Overvoltage protection: Varistor
- Compliant with EN 60950-1 and 61204-3
- Parallel working for increased load current (with OR diodes)
- Dual Polarity and Series connection permissible
- 35 mm rail (EN 60715) mount

Screw terminal



F For outline drawing see page 22

Output specification

Output current (-20...+40 °C, 230 V AC input)	A	10.8
Rated current I_N (50 °C, full input operating range)	A	10
Rated voltage	V	24
Rated power	W	240
Output power (-20...+40 °C, 230 V AC input)	W	250
Peak current capability for 5 ms*	A	25
Output voltage adjust	V DC	24...28
Voltage variation (from no-load to full-load)		< 1%
Voltage ripple @ full load**	mV	< 100
Hold-up time @ full load: with 110 V AC input ms		> 20
with 260 V AC input ms		> 20

Input specification

Nominal voltage (U_N)	V AC (50/60 Hz)	110...240
	V DC	110...240
Operating range	V AC (50/60 Hz)	88...265
	V DC	90...275 (non-polarised)
Drop out DC Voltage	V	80
Max power consumption (@ minimum V AC operating range)	VA	275 (@ 50 Hz)
	W	274 (@ 50 Hz)
Stand-by power consumption (@ 88 V)	W	≤ 2.8
Power factor		0.995
Max current consumption	A	3.0 (@ 88 V AC)
Max. inrush current (peak @ 265 V) for 3 ms	A	12
Replaceable input fuse		3.15 A - T

Technical data

Efficiency (@ 230 V AC)	%	93
MTTF	h	> 400 · 10 ³
Start-up delay	s	< 1
Dielectric strength between input/output	V AC	2500
Dielectric strength between input/PE	V AC	1500
Ambient temperature range***	°C	-20...+70
Protection category		IP 20

Approvals (according to type)**NEW 78.2E**

- 24 V DC, 240 W output
- Output adjustable between 24-28 V
- Double stage with active PFC (Power Factor Correction)

Replaceable fuse
+ spareThermal protection
with LED indicationAuxiliary contact
signalling

* (see diagrams P78)

** peak to peak, 100 Hz component, with 110 V AC input

*** (see derating diagrams L78)

Ordering information

Example: 78 series switch mode power supply, 36 W - 24 V DC output, supply voltage 110...240 V AC, replaceable fuse.

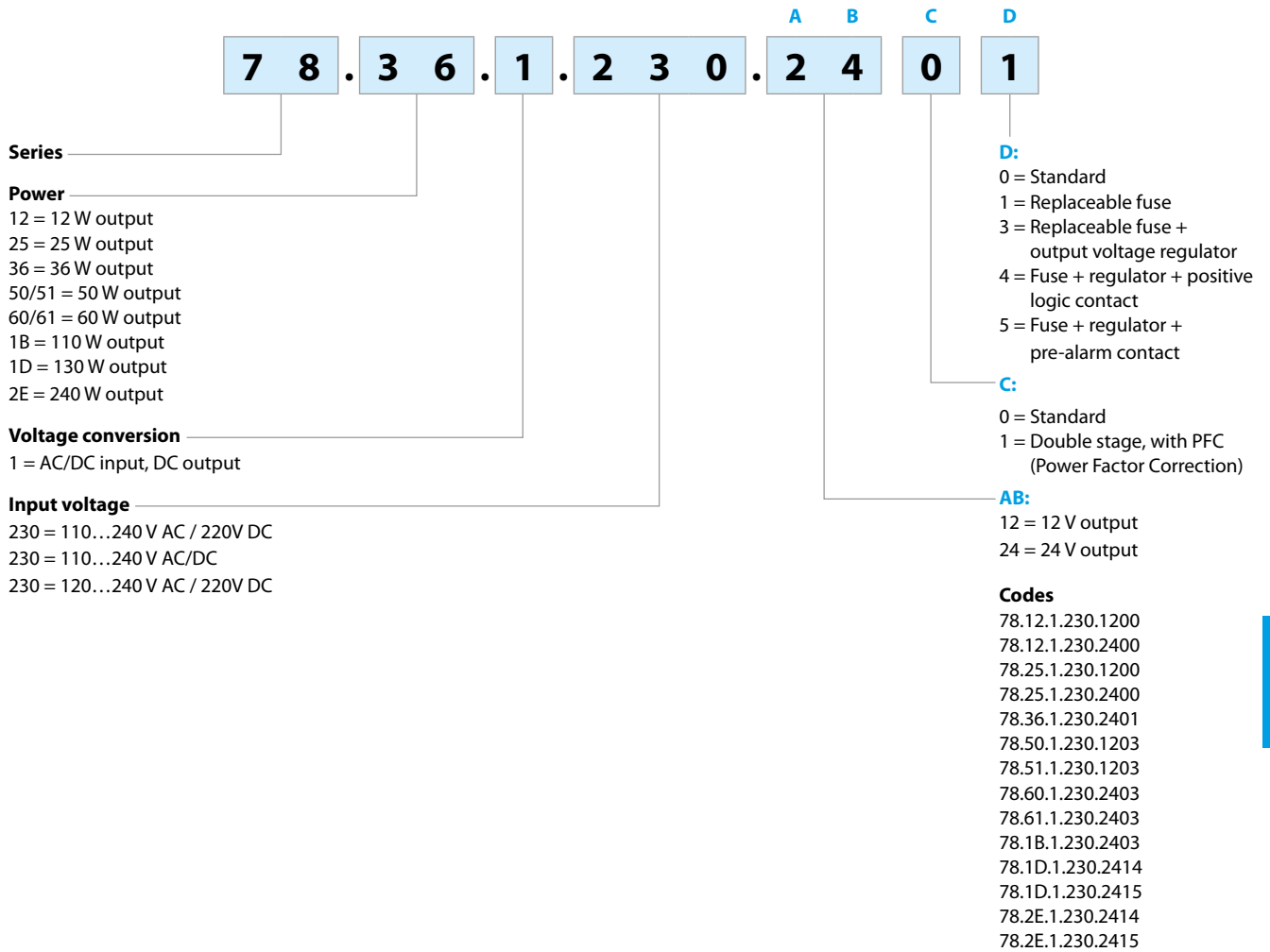

Technical data

EMC specifications (according to EN 61204-3)		Reference standard	78.12, 78.25, 78.36	78.60, 78.50	78.61, 78.51	78.1B	78.1D	78.2E
Electrostatic discharge	contact discharge	EN 61000-4-2	4 kV	4 kV	4 kV	4 kV	4 kV	4 kV
	air discharge	EN 61000-4-2	8 kV	8 kV	8 kV	8 kV	8 kV	8 kV
Radiated electromagnetic field	80...1000 MHz	EN 61000-4-3	6 V/m	10 V/m	10 V/m	10 V/m	10 V/m	10 V/m
	1...2.8 GHz	EN 61000-4-3	3 V/m	3 V/m	3 V/m	3 V/m	3 V/m	10 V/m
Fast transients (burst 5/50 ns, 5 and 100 kHz)	on supply terminals	EN 61000-4-4	2 kV	3 kV	3 kV	2 kV	3 kV	3 kV
Voltage pulses on supply terminals (surge 1.2/50 µs)	common mode	EN 61000-4-5	2 kV	2 kV	2 kV	2 kV	3 kV	2.5 kV
	differential mode	EN 61000-4-5	2 kV (78.12), 4 kV* (78.36)	4 kV*	4 kV*	4 kV**	4 kV**	4 kV**
Radio-frequency common mode voltage (0.15...230 MHz)	on supply terminals	EN 61000-4-6	6 V	10 V	10 V	10 V	10 V	10 V
Short interruptions		EN 61000-4-11	5 cycles	6 cycles	6 cycles	5 cycles	6 cycles	5 cycles
Radio-frequency conducted emissions	0.15...30 MHz	EN 55022	class B	class A	class B	class B	class B	class B
Radiated emissions	30...1000 MHz	EN 55022	class B	class A	class B	class B	class A	class A
Terminals			Max			Min...Max		
Wire size (Solid cable, stranded cable)		mm ²	1 x 4 / 2 x 2.5			1 x 0.5...1 x 4		
		AWG	1 x 12 / 2 x 14			1 x 20...1 x 12		
 Screw torque		Nm	0.8			0.5		
Wire strip length		mm	9			9		
Other data								
Power lost to the environment with rated output current		W	2 (78.12), 2.3 (78.25), 5 (78.36, 78.50/51), 5.4 (78.60/61)					
		W	9 (78.1B), 13.2 (78.1D), 16.8 (78.2E)					

* input fuse may blow for surges higher than 1.5 kV

** input fuse may blow for surges higher than 2 kV

Output specification

L78-1 Output current v ambient temperature (78.12)

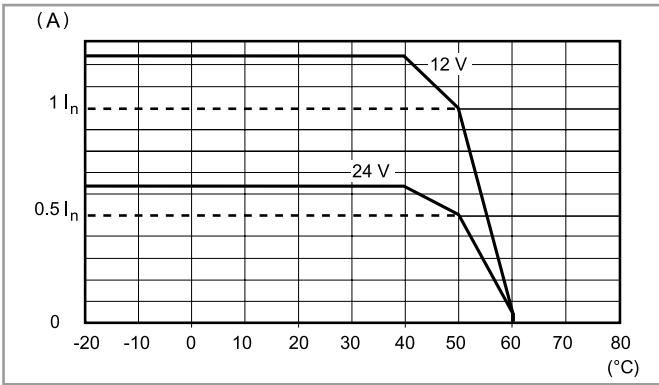

P78-1 Output peak current v time (78.12)

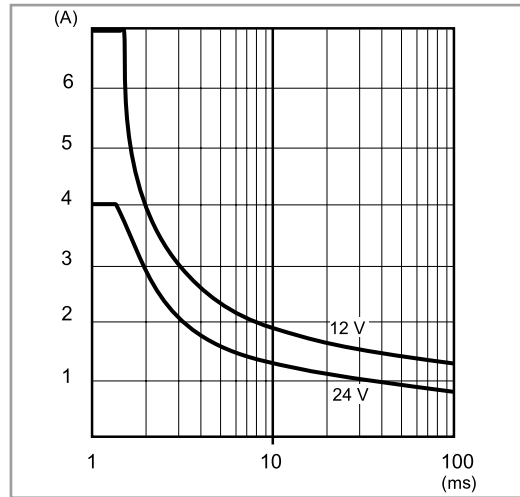

L78-2 Output current v ambient temperature (78.25)

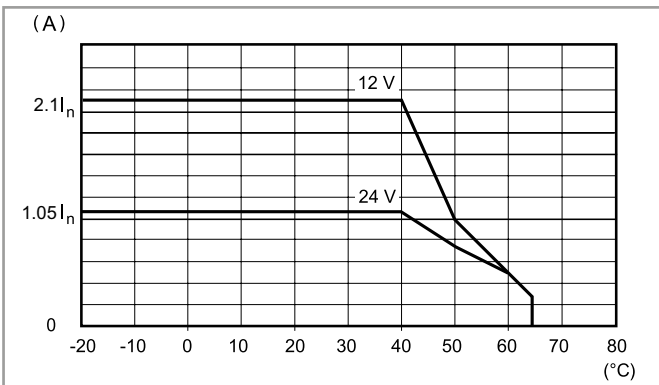

P78-1 Output peak current v time (78.25)

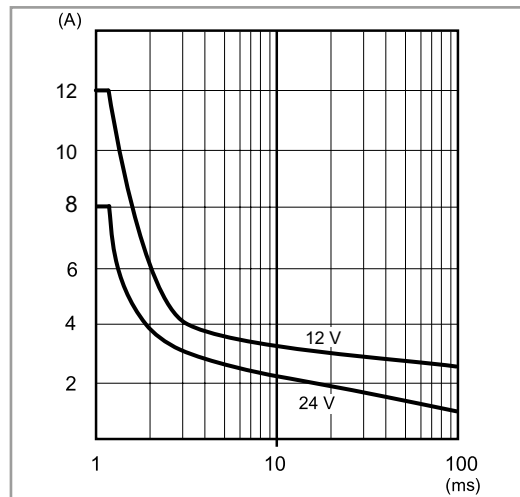

L78-2 Output current v ambient temperature (78.36)

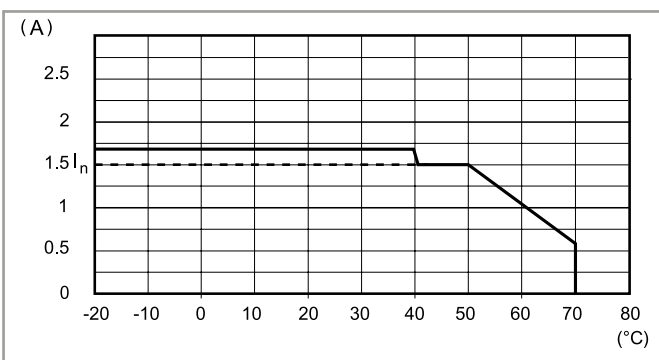

P78-2 Output peak current v time (78.36)

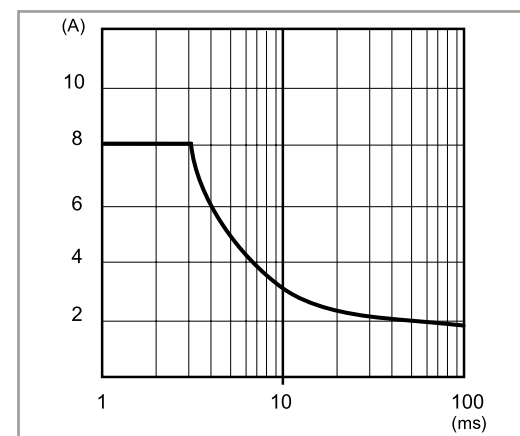

Output specification

L78-3 Output current v ambient temperature (78.60)

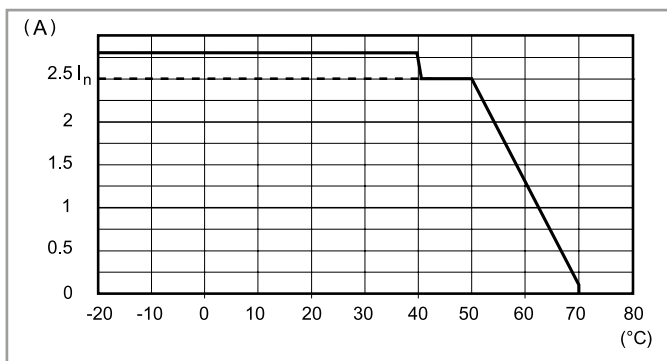

P78-3 Output peak current v time (78.60)

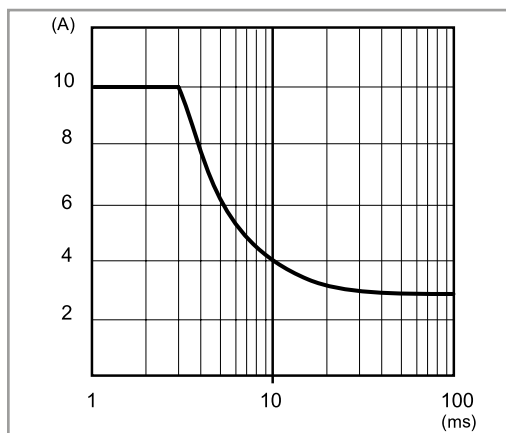

L78-4 Output current v ambient temperature (78.50/51)

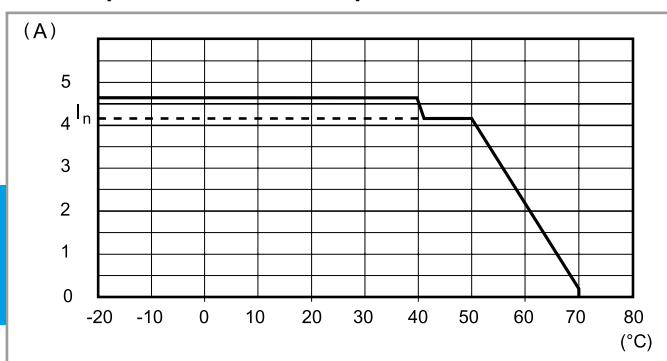

P78-4 Output peak current v time (78.50/51)

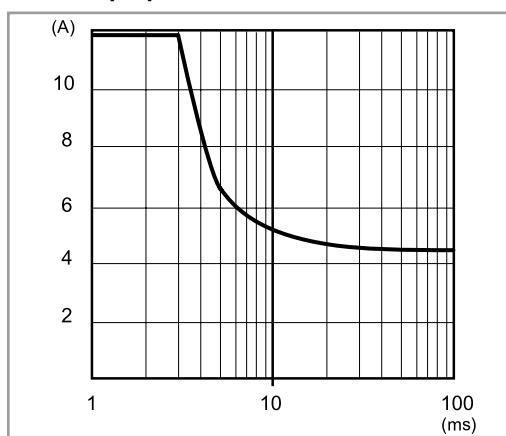

L78-5 Output current v ambient temperature (78.61)

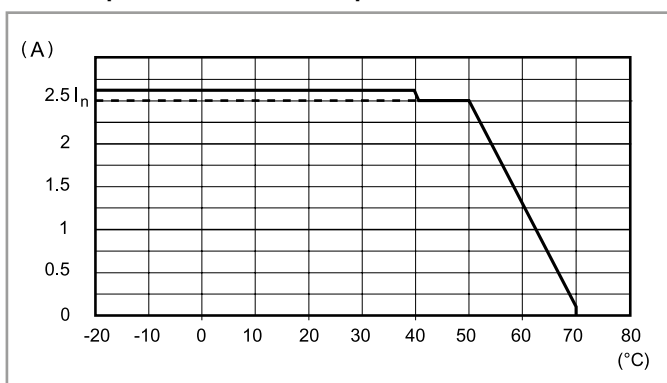

P78-5 Output peak current v time (78.61)

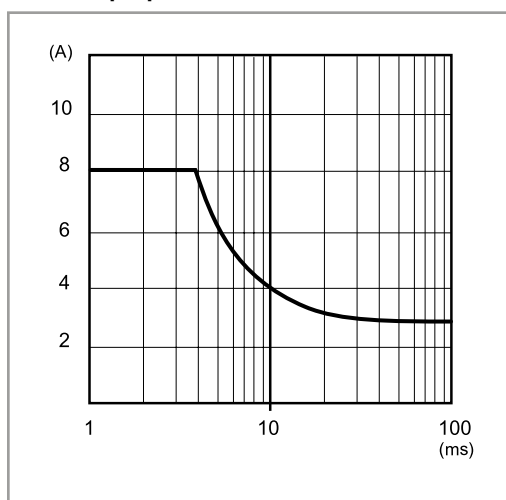

F

Output specification

L78-6 Output current v ambient temperature (78.1B)

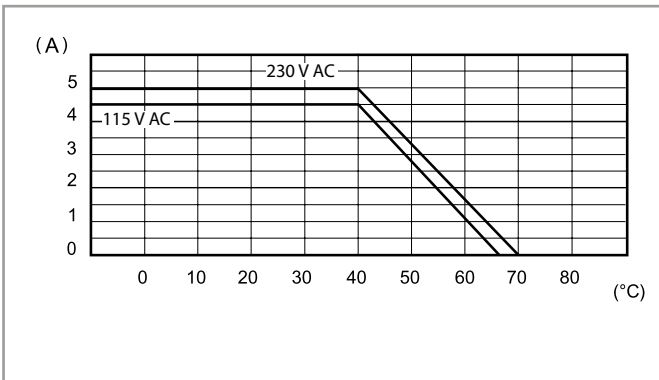

P78-6 Output peak current v time (78.1B)

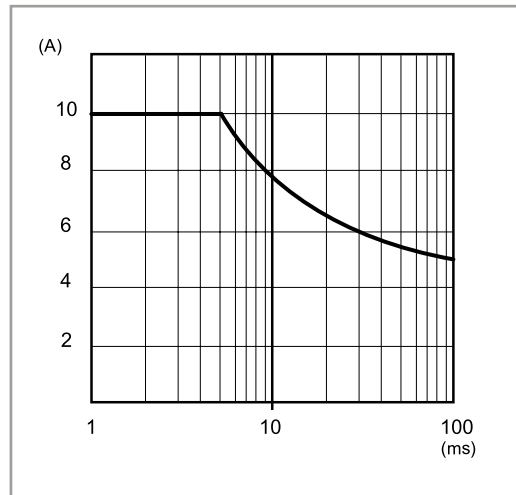

L78-7 Output current v ambient temperature (78.1D)

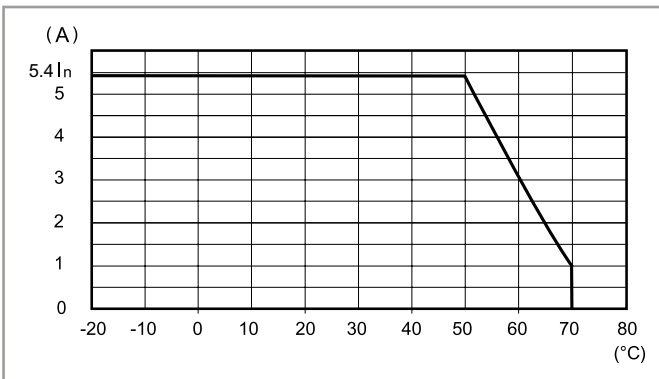

P78-7 Output peak current v time (78.1D)

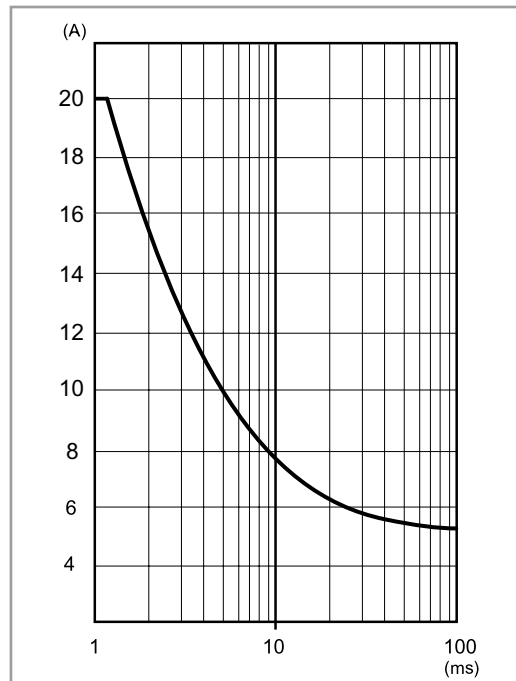

L782E-1 Output current v ambient temperature (78.2E)

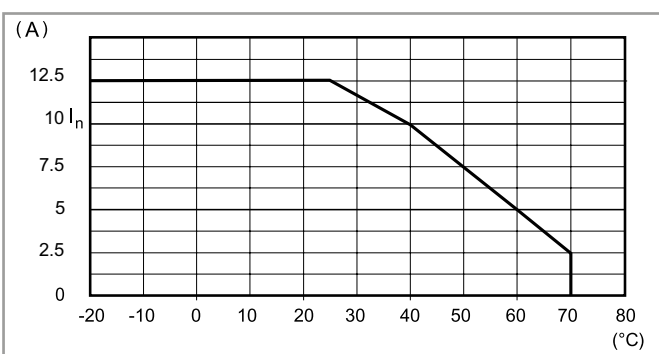

P782E-1 Output peak current v time (78.2E)

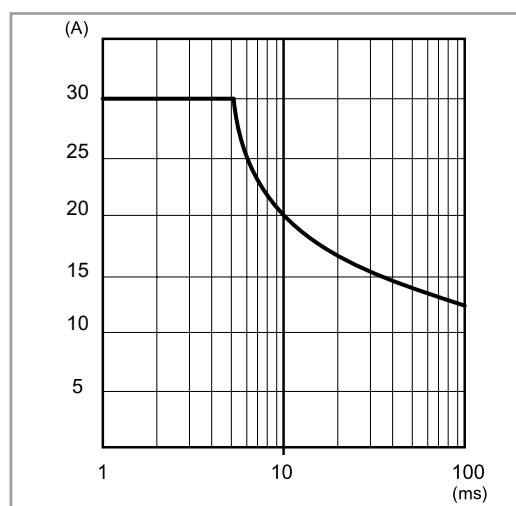

Output specification

FB78-5 Output voltage v output current (78.2E)

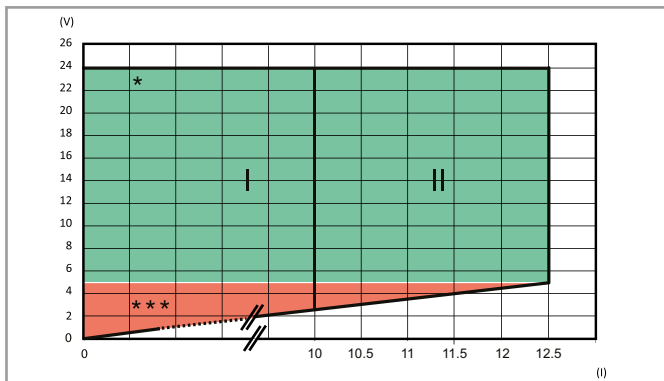

I: Output characteristic for temperature up to 50 °C

II: Output characteristic for temperature up to 25 °C

* / ***: See LED table below

Hiccup mode

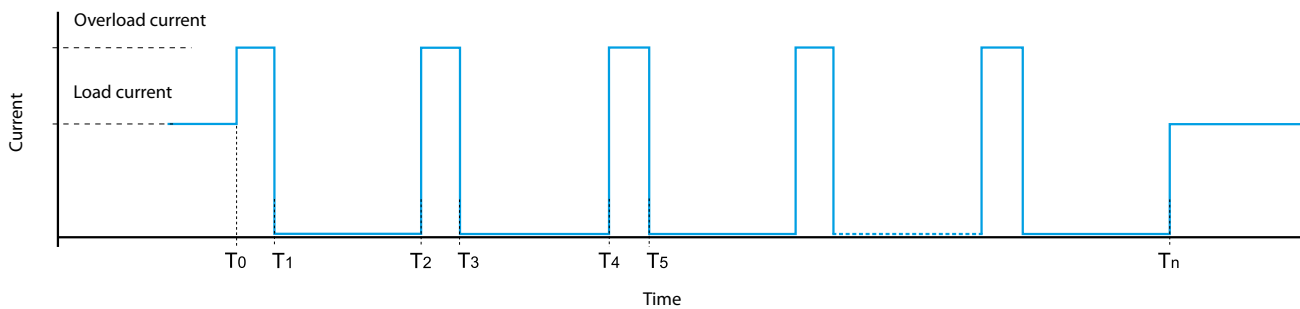

Under normal conditions, the 78 Series Power Supply supplies the current required by the load.

However, under abnormal conditions such as a short circuit or heavy overload (T_0) the output voltage will be rapidly reduced to zero - followed by the current (T_1). After approximately 2 seconds (T_1 to T_2), the power supply checks for the persistence of the anomaly over the time period T_2 to T_3 (30 to 100ms - dependent on the type of anomaly). If the anomaly persists, as shown above, the current is again reset to 0 A for a further 2 s (T_3 to T_4). This "hiccup" process is repeated until the anomaly is removed (T_n), whereon the power supply then returns to normal working.

78.1B is able to handle this anomaly for 15 s. After this time it enters in protection mode, and a manual reset is necessary by removing and re-applying the supply voltage

Fold-back technology and battery charging

Fold-back technology allows load current to be maintained under conditions of heavy overload. In case of heavy overload, the fold-back circuit will provide the output current and the output voltage, in accordance with the relevant "FB" diagram. In practice, when overcurrent is drawn by the load, the fold-back circuit reduces the output voltage supplying the current up to the maximal value, then it starts to work in hiccup mode. Also in case of short circuit, the power supply will work in hiccup mode. Both these conditions end when the anomaly is removed, and the power supply returns to normal working.

The fold-back mode allows the use of the power supply as a **battery charger**, in particular 78.51/61 for charging lead acid batteries (both standard and gel types) rated 7...24 Ah and 78.1D for charging lead batteries rated 17...38 Ah. In any case, it is necessary to verify that the charging characteristics of the batteries are compliant with the output characteristics of the power supply.

It is suggested to insert a diode in series between the + output and the + input of the battery (if not already installed in the battery unit).

Back-up connection for mains interruption

When the mains is ON, the power supply is able to charge the battery and supply the load at the same time (the power supply must be rated minimum 110 % of the load). When the mains is OFF, the battery starts to supply the load.

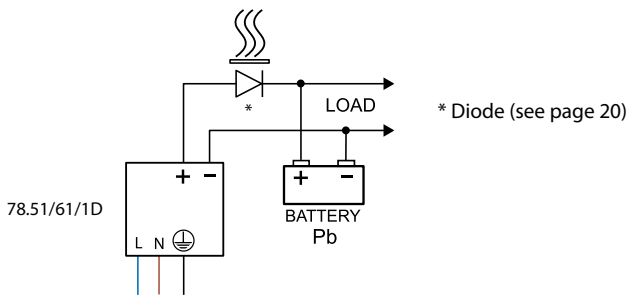

FB78-1 Output voltage v output current (78.51)

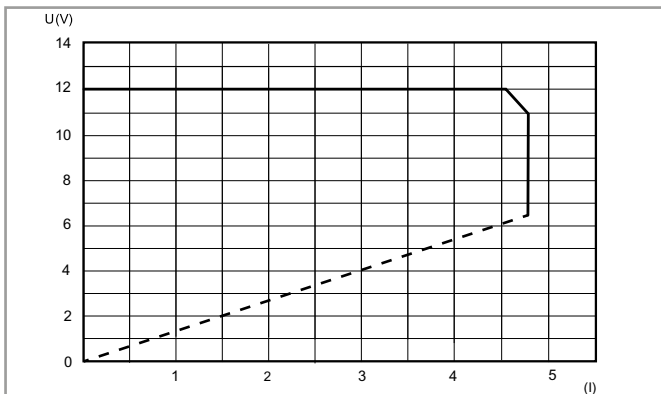

FB78-2 Output voltage v output current (78.61)

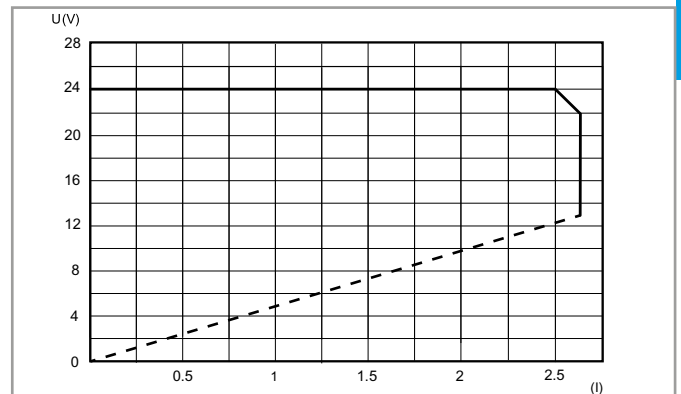

FB78-3 Output voltage v output current (78.1D)

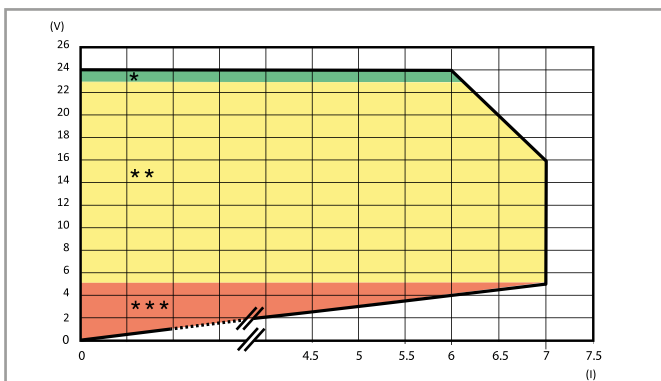

Fold-back characteristic for ambient temperature up to 50 °C























* / ** / ***: See LED table below

78.1D, 78.2E LED table

Feedback contact switching mode: Type 78.xx.x.xxx.24x4 ("positive logic")

The NO contact closes when power is applied to the unit and remains closed unless there is a serious fault preventing the power supply unit from delivering output current. (Such as a broken fuse, power supply failure, short-circuit or thermal protection.)

This version is suitable, for example, for signalling to a remote PLC all those alarms representing a service interruption of the power supply output.

Type	Area	State	LED	Contact 13-14
78.1D.1.230.2414 78.2E.1.230.2414	*	OK	DC OK  ALARM   OFF	
	**	Overload (78.1D only)	DC OK  ALARM   OFF	
	***	Short circuit	DC OK  ALARM   OFF	
		Thermal limit	DC OK  ALARM   OFF	
		Thermal protection [#]	DC OK  ALARM   OFF	

[#]Remove the supply voltage, following the intervention of the thermal protection, in order to reset the power supply.













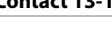







78.1D, 78.2E LED table

F

Feedback contact switching mode: Type 78.xx.x.xxx.24x5 ("pre-alarm")





The NO contact closes when an anomaly happens (Overload, short circuit, thermal limit, thermal protection).

This version is suitable, for example, for activating visual or audible alarms, or to activate a cooling fan.

Type	Area	State	LED	Contact 13-14
78.1D.1.230.2415 78.2E.1.230.2415	*	OK	DC OK  ALARM   OFF	
	**	Overload (78.1D only)	DC OK  ALARM   OFF	
	***	Short circuit	DC OK  ALARM   OFF	
		Thermal limit	DC OK  ALARM   OFF	
		Thermal protection [#]	DC OK  ALARM   OFF	

[#]Remove the supply voltage, following the intervention of the thermal protection, in order to reset the power supply.

78.12, 78.25, 78.36, 78.50, 78.60, 78.51, 78.61, 78.1B LED table

Type	State	LED
78.12.1.230.xx00 78.25.1.230.1200 78.25.1.230.2400	OK	
78.36.1.230.2401 78.50.1.230.1203 78.60.1.230.2403 78.51.1.230.1203 78.61.1.230.2403	Short circuit	
	Thermal limit	OFF
78.1B.1.230.2403	OK	
	Short circuit	 15s OFF
	Thermal limit	OFF

Wiring diagrams for 78.12, 78.25, 78.36, 78.50, 78.51, 78.60 & 78.61

Basic connections

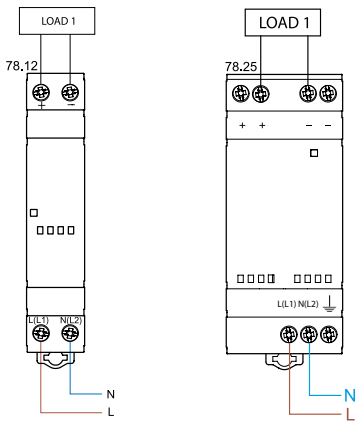

Basic connections

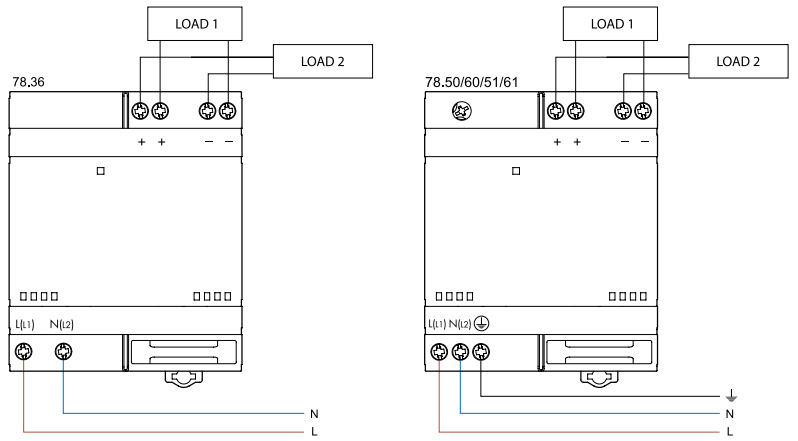

Dual polarity connection

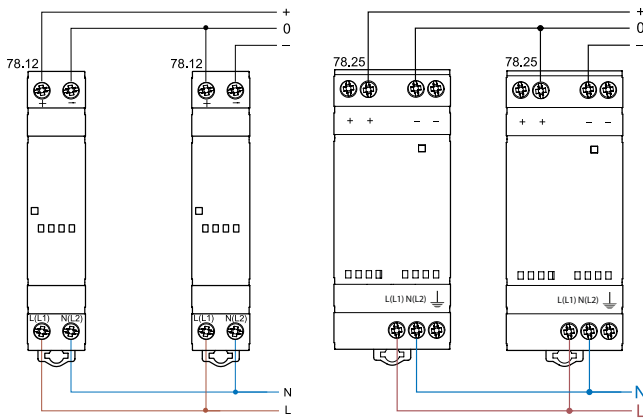

Dual polarity connection

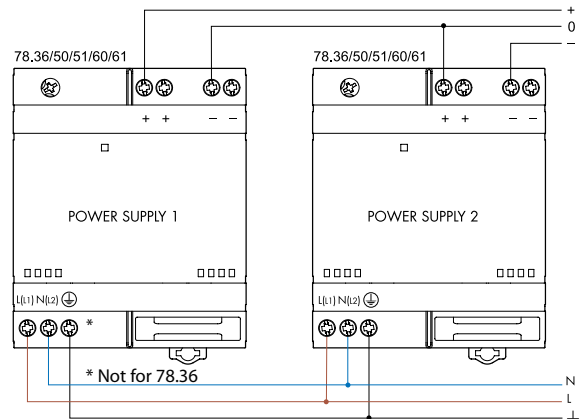

Series connection

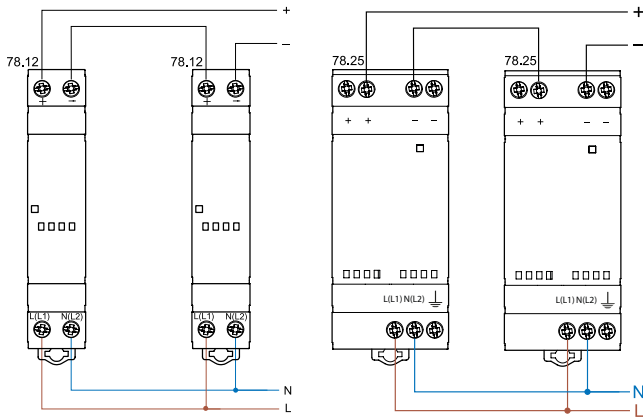

Series connection

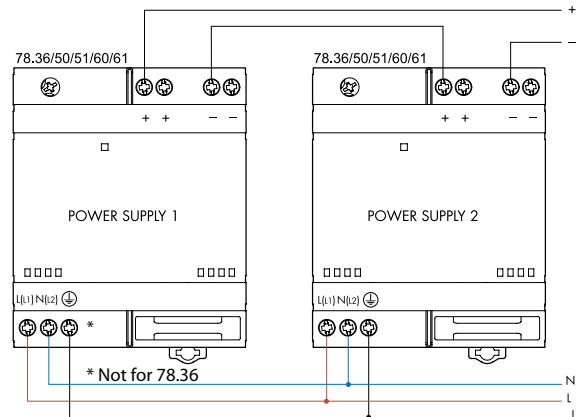

Parallel connection (78.51/61 only)

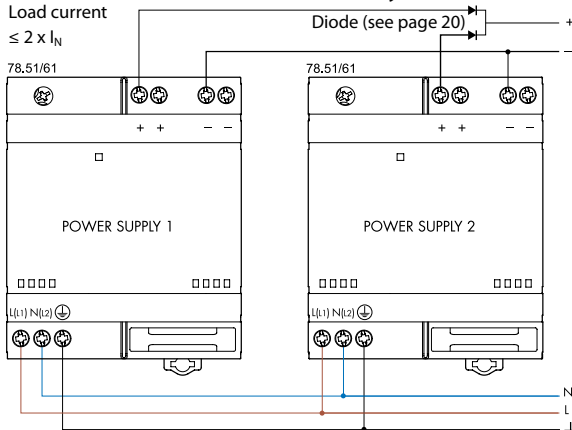

Manual redundancy

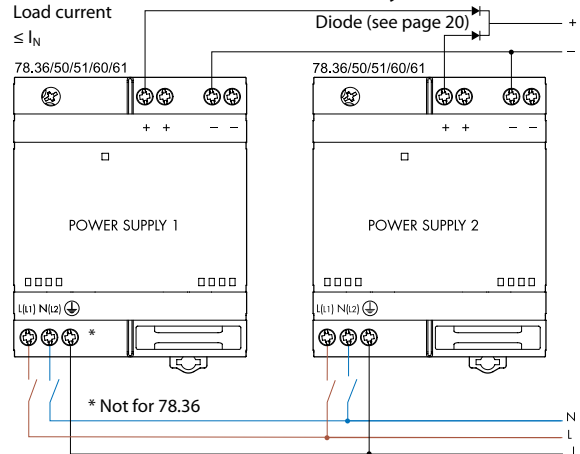

Wiring diagrams for 78.1B & 78.1D

Basic connections

78.1B - Power supply connection

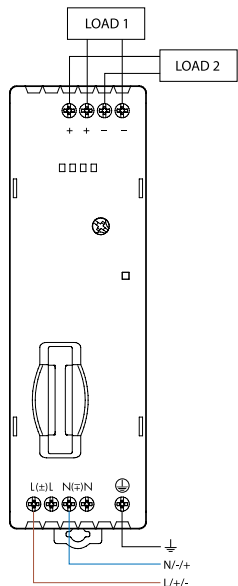

78.1D - Power supply connection

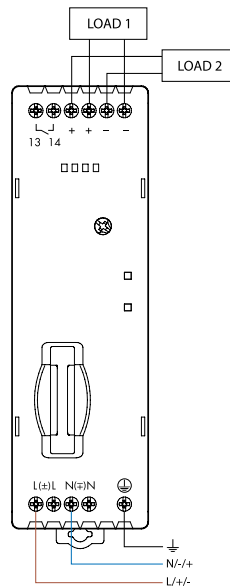

Dual polarity connection

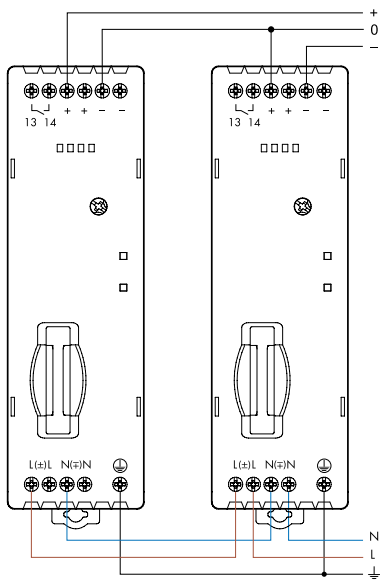

Parallel connection

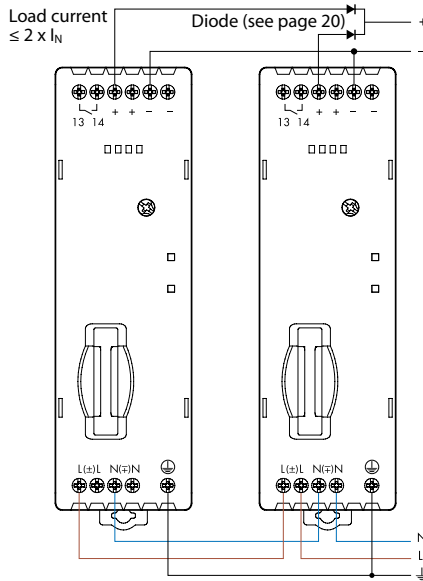

Series connection

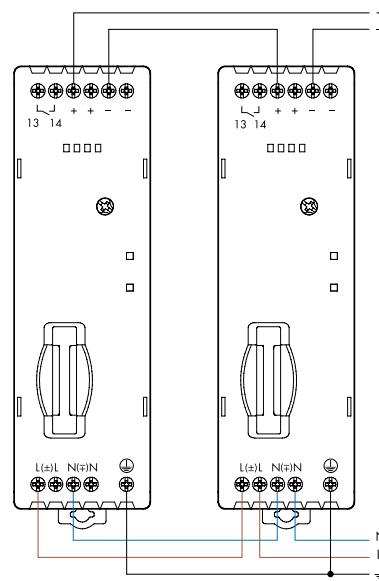

F

Wiring diagrams for 78.2E

Basic connections

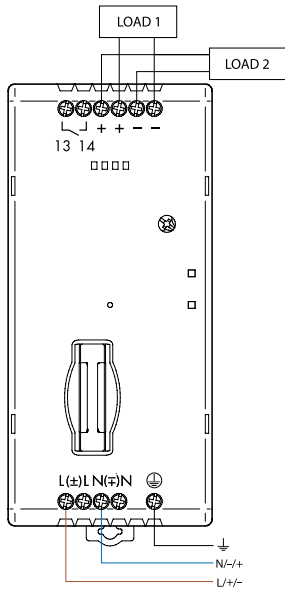

Dual polarity connection

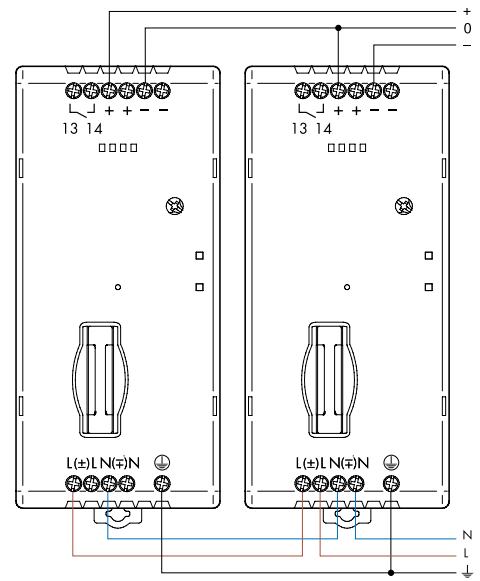

Parallel connection

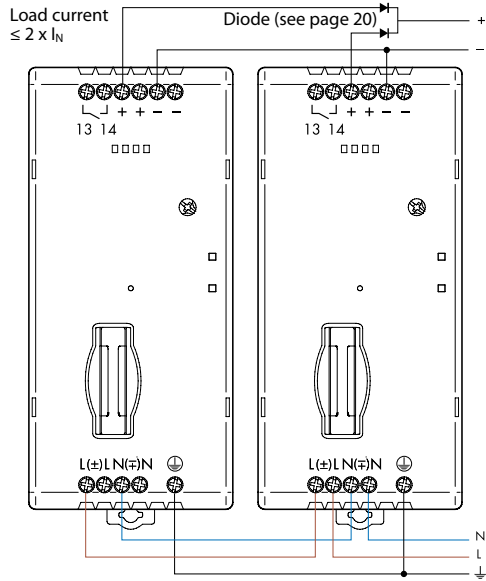

Series connection

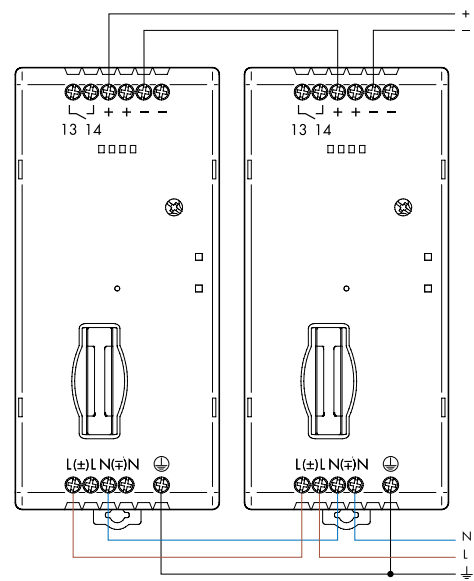

F

Diode(s)

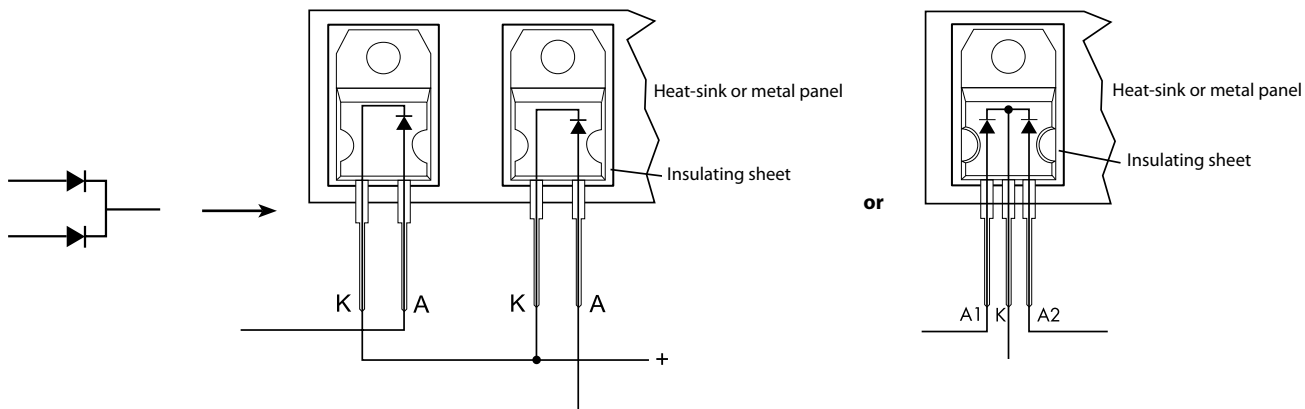

Diode for type 78.25, 78.36, 78.50, 78.60, 78.51, 78.61

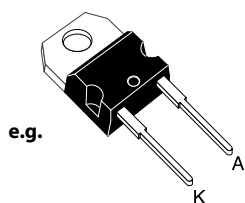

e.g.

TO-220AC
STPS1545D

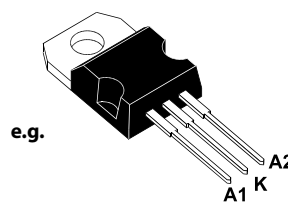

e.g.

TO-220AB
STPS30L40CT

Diode for type 78.1B, 78.1D, 78.2E

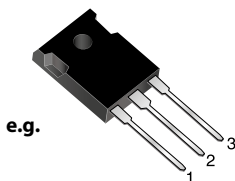

e.g.

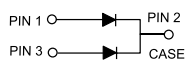

TO-247AD
MBR 4060PT

Outline drawings

78.12
Screw terminal

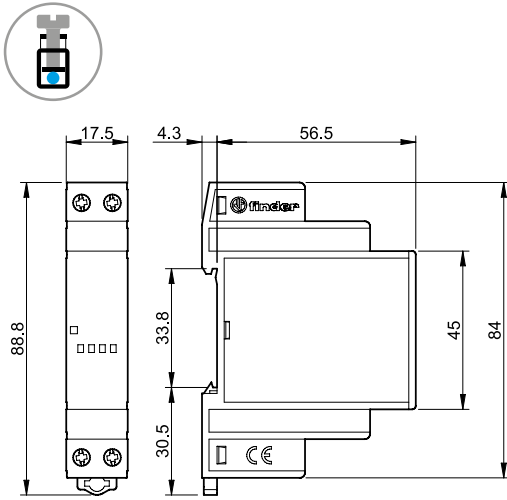

78.25
Screw terminal

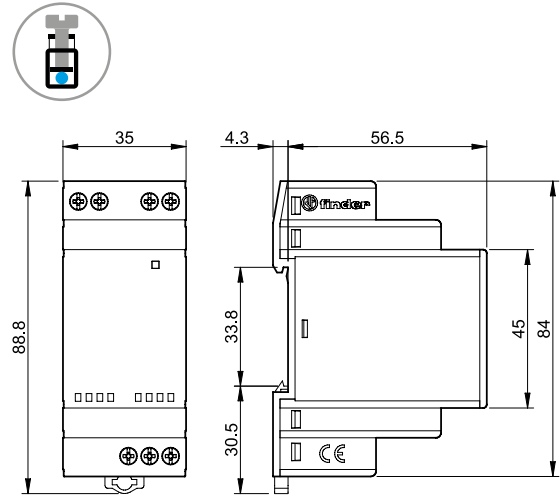

78.36
Screw terminal

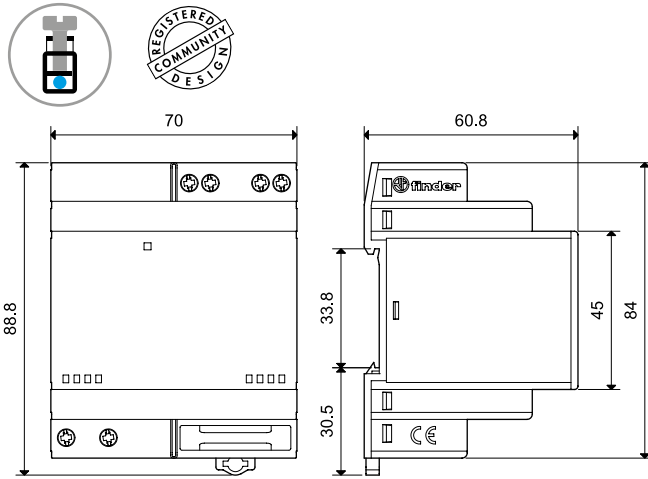

78.50 / 78.60
Screw terminal

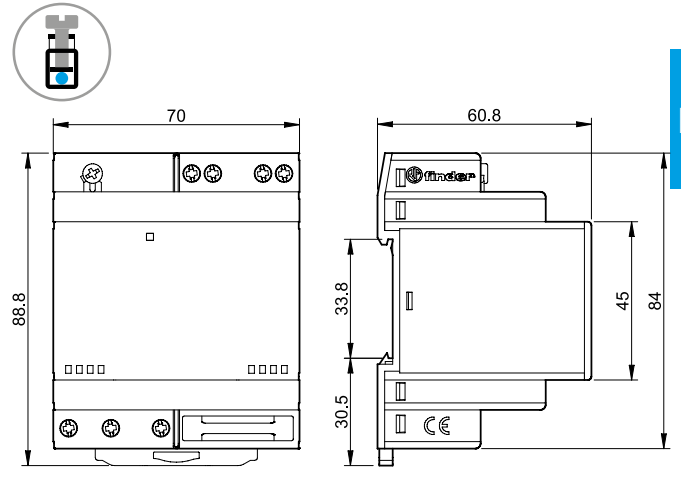

78.51 / 78.61
Screw terminal

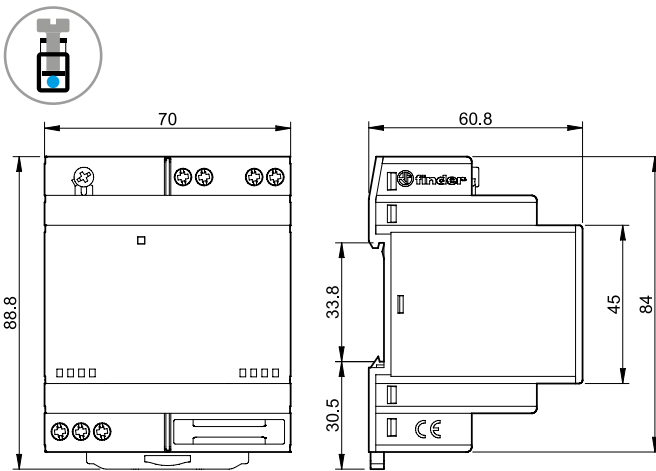

78.1B
Screw terminal

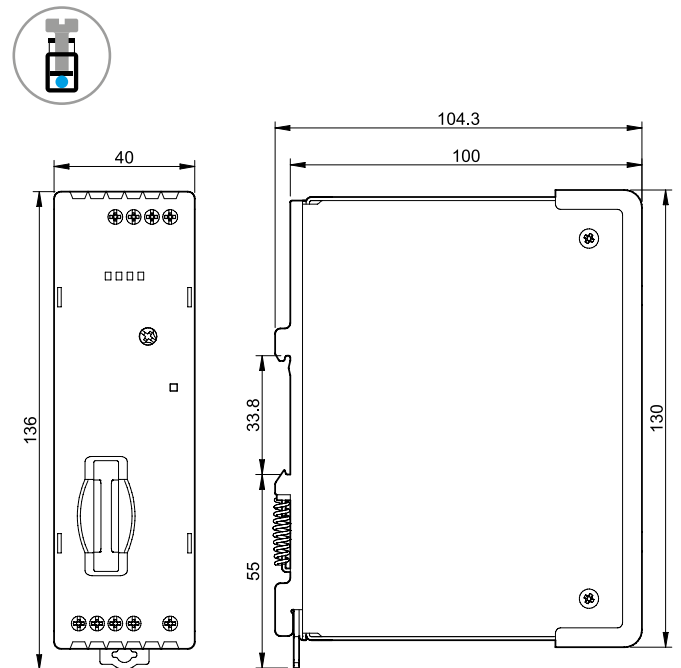

Outline drawings

78.1D
Screw terminal

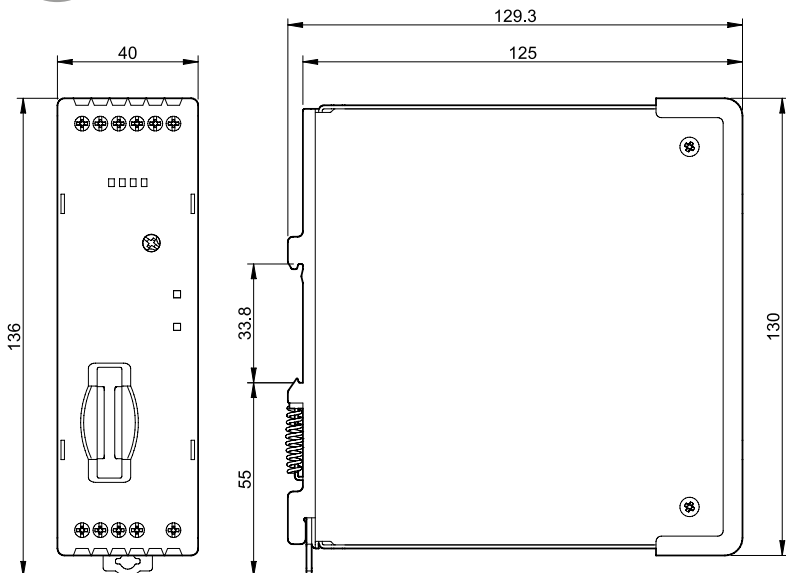

F

78.2E
Screw terminal

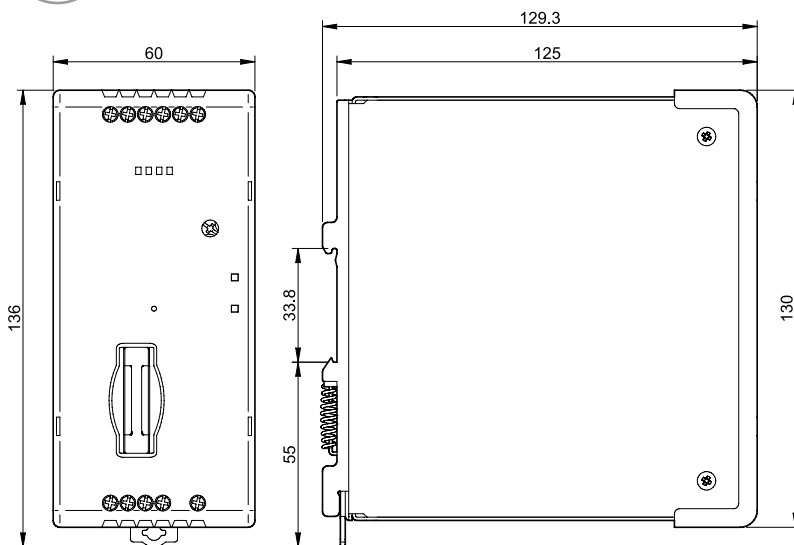

Accessories

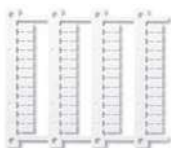

060.48

Sheet of marker tags (CEMBRE Thermal transfer printers), (48 tags), 6 x 12 mm

060.48



019.01

Identification tag, plastic, 1 tag, 17 x 25.5 mm (for 78.12/25/36/50/60/51/61)

019.01



finder[®]
SWITCH TO THE FUTURE

Panel Thermostat

7T
SERIES



Drying kilns



Industrial refrigeration



Road / tunnel lighting



Industrial furnaces and ovens



Automatic car-washes



Panels for electrical distribution



Control panels



Forced-air ventilators

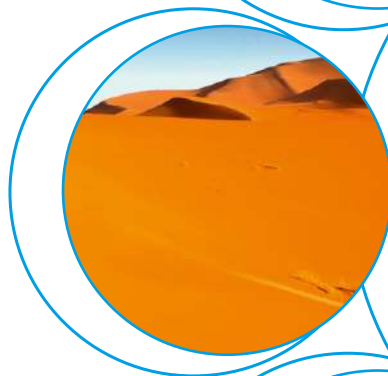

Panel thermostat

- Small, compact size (17.5 mm wide)
- Snap action thermostatic Bimetal sensor
- Wide temperature setting range
- Long electrical life
- 35 mm rail (EN 60715) mount

NEW 7T.81.0.000.240x



• Heating control

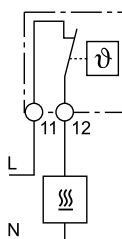
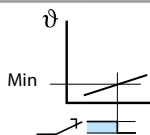

NEW 7T.81.0.000.230x



• Ventilation control

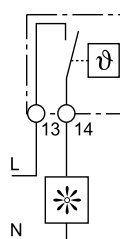
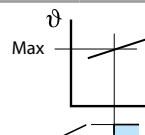

Heating control - Should the panel temperature fall below the (minimum) set temperature the contact will close to call for heat. The contact will open when this set temperature is exceeded.

Ventilation control - Should the panel temperature exceed the (maximum) set temperature then the contact will close to call for cooling. The contact will open when the temperature falls below this set temperature.

For outline drawing see page 4

Contact specification

Contact configuration		1 NC	1 NO
Rated current/Maximum peak current	A	10/20	10/20
Rated voltage/ Maximum switching voltage	V AC	250/250	250/250
Rated load AC1	VA	2500	2500
Rated load AC15 (230 V AC)	VA	250	250
Single phase motor rating AC3 (230 V AC)	kW	1.1	1.1
Breaking capacity DC1: 30/110/220 V	A	1/0.3/0.15	1/0.3/0.15
Minimum switching load	mW (V/mA)	500 (12/10)	500 (12/10)
Standard contact material		AgNi	AgNi

Temperature setting range

Setting range (ventilation)	°C	—	-20...+40	+0...+60
Switch temperature differential	K	—	7 ± 4	
Setting range (heating)	°C	-20...+40	+0...+60	—
Switch temperature differential	K	7 ± 4		—

Technical data

Electrical life at rated load AC1	cycles	100 · 10 ³	100 · 10 ³
Ambient temperature range	°C	-45...+80	-45...+80
Protection category		IP 20	IP 20

Approvals (according to type)



Ordering information

Example: 7T Series, thermostat for ventilation control, contact activates ventilation should the panel temperature exceed the set value (max+60 °C), 35 mm rail (EN 60715) mount.

7 T . 8 1 . 0 . 0 0 0 . 2 3 0 3

Series ————
Type ————
 8 = 35 mm rail (EN 60715) mount
No. of contacts ————
 1 = 1 contact
Voltage type ————
 0 = No operating voltage required
Rated operating voltage ————
 000 = No operating voltage required

Control function
 (Temperature only)
 1 = (-20...+40)°C
 3 = (0...+60)°C
Contact configuration
 3 = 1 NO contact
 4 = 1 NC contact
Monitoring function
 2 = Temperature, adjustable

Technical data

Insulation			
Dielectric strength between open contacts	V AC	500	
Other data			
Screw torque	Nm	0.5	0.5
Max. wire size		solid cable	stranded cable
	mm ²	1 x 2.5	1 x 1.5
	AWG	1 x 12	1 x 16

G

Outline drawings

7T.81
Screw terminal

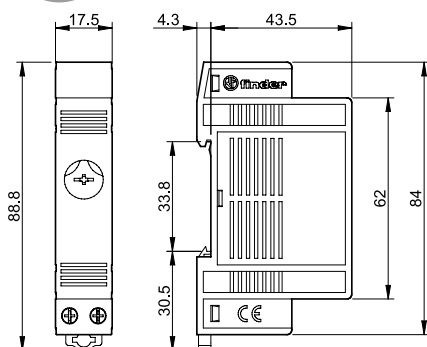



finder[®]
SWITCH TO THE FUTURE

Filter Fan (24...630)m³/h and Exhaust Filter

7F
SERIES



Drying kilns



Textile machines



Machines
for paper
processing



Machines for
ceramics



Wood-
processing
machines



Panels for
electrical
distribution



Control panels



Forced-air
ventilators

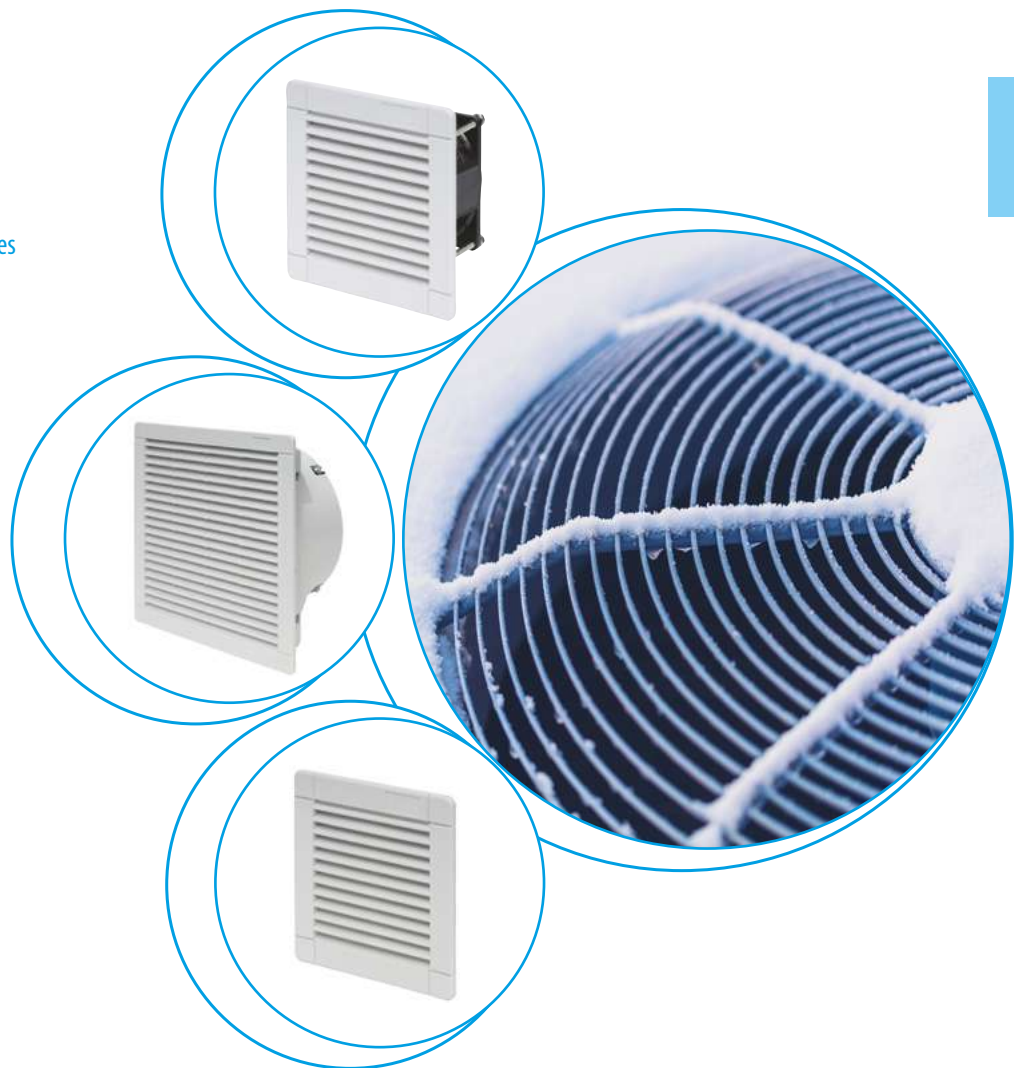

Filter Fan for electrical cabinets and enclosures 120 V or 230 V AC versions

- Very low acoustic noise
- Minimal depth within enclosure
- Air volume (14...470)m³/h (with Exhaust Filter installed in cabinet)
- Air volume (24...630)m³/h (free flow)
- Power consumption (4...130)W
- Operating voltage: 120 or 230 V AC (50/60 Hz)
- Time-saving installation and maintenance
- Further available versions*:
 - EMC Filter Fan (7F.70) and EMC Exhaust Filter (7F.07)
 - Filter Fan supplied in Reverse flow mode (7F.80)

* Product codes, see pages 8 & 11

Note:

By reversing the fan motor, the air direction can be changed from "Inlet" Filter Fan mode to "Exhaust" Filter Fan mode** (except for the types 7F.50.8.xxx.4370, 7F.50.8.xxx.5500 and 7F.50.8.xxx.5630).

** Supplied in "Inlet" Filter Fan mode (Standard).

7F.50.8.xxx.1020



- Operating voltage (120 or 230)V AC
- Air volume 24 m³/h
- Rated power 13 W
- Size 1

7F.50.8.xxx.2055



- Operating voltage (120 or 230)V AC
- Air volume 55 m³/h
- Rated power 22 W
- Size 2

7F.50.8.xxx.3100



- Operating voltage (120 or 230)V AC
- Air volume 100 m³/h
- Rated power 22 W
- Size 3

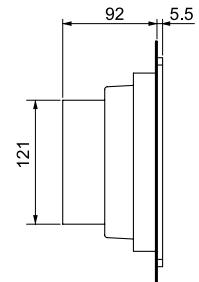
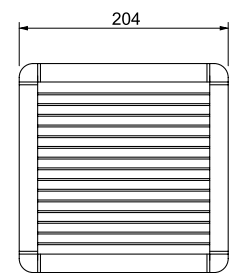
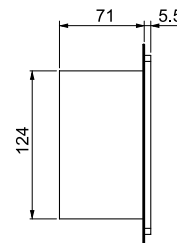
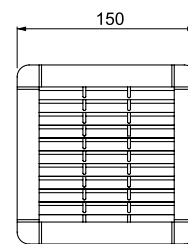
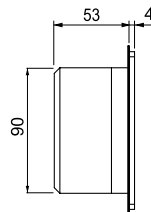
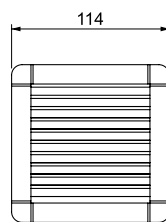

Fan data							
Air volume (free flow)	m ³ /h	24		55		100	
Air volume (with exhaust filter installed)	m ³ /h	14		40		75	
Noise level	dB (A)	30		43		43	
Life time at 40 °C	h	50000		50000		50000	
Electrical data							
Operating voltage	V AC (50/60 Hz)	120	230	120	230	120	230
Current consumption	A	0.14	0.1	0.26	0.14	0.26	0.14
Rated power	W	13	13	22	22	22	22
Other data							
Housing, cover		Plastics according to UL94 V-0, light gray (RAL 7035)					
Filter mat (included)		G3 according to EN 779, filtering degree (80...90)%					
Filter material		Synthetic fibre with progressive construction, temperature resistant to +100 °C, self extinguishing, Class F1 (DIN 53438)					
Electrical connections/wire size		3-pole screw terminals/max. 2.5 mm ²					
Screw torque	Nm	0.8					
Ambient temperature range	°C	-10...+70					
Protection class		I					
Protection category according to EN 60529		IP54					
Approvals (according to type)							

Filter Fan for electrical cabinets and enclosures 120 V or 230 V AC versions

- Very low acoustic noise
- Minimal depth within enclosure
- Air volume (14...470)m³/h (with Exhaust Filter installed in cabinet)
- Air volume (24...630)m³/h (free flow)
- Power consumption (4...130)W
- Operating voltage: 120 or 230 V AC (50/60 Hz)
- Time-saving installation and maintenance
- Further available versions*:
 - EMC Filter Fan (7F.70) and EMC Exhaust Filter (7F.07)
 - Filter Fan supplied in Reverse flow mode (7F.80)

* Product codes, see pages 8 & 11

7F.50.8.xxx.4230



- Operating voltage (120 or 230)V AC
- Air volume 230 m³/h
- Rated power 40 W
- Size 4

7F.50.8.xxx.4370



- Operating voltage (120 or 230)V AC
- Air volume 370 m³/h
- Rated power 70 W
- Size 4

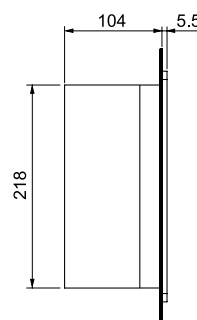
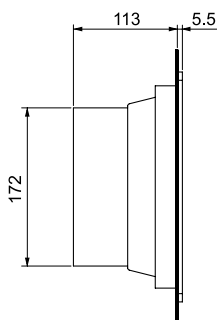
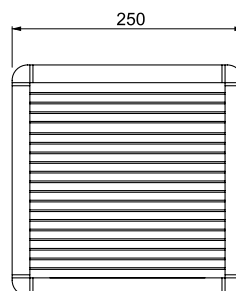
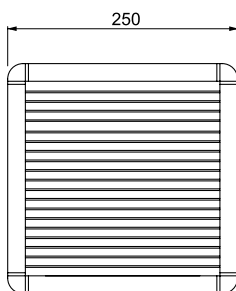

G

Note:
By reversing the fan motor, the air direction can be changed from "Inlet" Filter Fan mode to "Exhaust" Filter Fan mode** (except for the types 7F.50.8.xxx.4370, 7F.50.8.xxx.5500 and 7F.50.8.xxx.5630).

** Supplied in "Inlet" Filter Fan mode (Standard).

Fan data

Air volume (free flow)	m ³ /h	230	370
Air volume (with exhaust filter installed)	m ³ /h	180	250
Noise level	dB (A)	53	65
Life time at 40 °C	h	50000	50000

Electrical data

Operating voltage	V AC (50/60 Hz)	120	230	120	230
Current consumption	A	0.34	0.17	0.8	0.4
Rated power	W	40	40	70	70

Other data

Housing, cover	Plastics according to UL94 V-0, light gray (RAL 7035)
Filter mat (included)	G3 according to EN 779, filtering degree (80...90)%
Filter material	Synthetic fibre with progressive construction, temperature resistant to +100 °C, self extinguishing, Class F1 (DIN 53438)
Electrical connections/wire size	3-pole screw terminals/max. 2.5 mm ²
Screw torque	Nm 0.8
Ambient temperature range	°C -10...+70
Protection class	I
Protection category according to EN 60529	IP54

Approvals (according to type)



Filter Fan for electrical cabinets and enclosures 120 V or 230 V AC versions

- Very low acoustic noise
- Minimal depth within enclosure
- Air volume (14...470)m³/h (with Exhaust Filter installed in cabinet)
- Air volume (24...630)m³/h (free flow)
- Power consumption (4...130)W
- Operating voltage: 120 or 230 V AC (50/60 Hz)
- Time-saving installation and maintenance
- Further available versions*:
 - EMC Filter Fan (7F.70) and EMC Exhaust Filter (7F.07)
 - Filter Fan supplied in Reverse flow mode (7F.80)

* Product codes, see pages 8 & 11

7F.50.8.xxx.5500



- Operating voltage (120 or 230)V AC
- Air volume 500 m³/h
- Rated power 70 W
- Size 5

7F.50.8.xxx.5630



- Operating voltage (120 or 230)V AC
- Air volume 630 m³/h
- Rated power 130 W
- Size 5

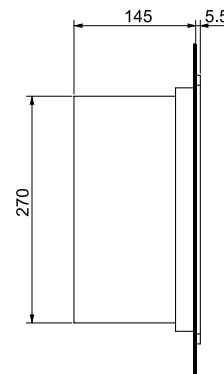
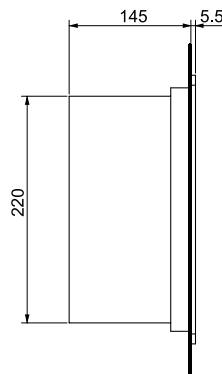
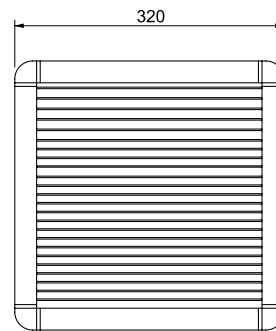
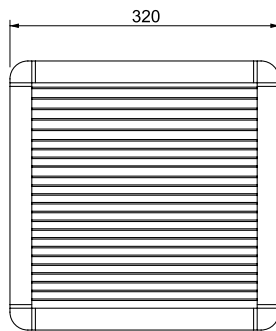

Note:

By reversing the fan motor, the air direction can be changed from "Inlet" Filter Fan mode to "Exhaust" Filter Fan mode** (except for the types 7F.50.8.xxx.4370, 7F.50.8.xxx.5500 and 7F.50.8.xxx.5630).

** Supplied in "Inlet" Filter Fan mode (Standard).

Fan data

Air volume (free flow)	m ³ /h	500		630	
Air volume (with exhaust filter installed)	m ³ /h	370		470	
Noise level	dB (A)	65		72	
Life time at 40 °C	h	50000		50000	

Electrical data

Operating voltage	V AC (50/60 Hz)	120	230	120	230
Current consumption	A	0.8	0.4	1.10	0.55
Rated power	W	70	70	130	130

Other data

Housing, cover	Plastics according to UL94 V-0, light gray (RAL 7035)				
Filter mat (included)	G3 according to EN 779, filtering degree (80...90)%				
Filter material	Synthetic fibre with progressive construction, temperature resistant to +100 °C, self extinguishing, Class F1 (DIN 53438)				
Electrical connections/wire size	3-pole screw terminals/ max. 2.5 mm ²		4-pole screw terminals/ max. 2.5 mm ²		
Screw torque	Nm	0.8			
Ambient temperature range	°C	-10...+70			
Protection class	I				
Protection category according to EN 60529	IP54				

Approvals (according to type)



Filter Fan for electrical cabinets and enclosures 24 V DC versions

- Very low acoustic noise
- Minimal depth within enclosure
- Air volume (14...470)m³/h (with Exhaust Filter installed in cabinet)
- Air volume (24...630)m³/h (free flow)
- Power consumption (4...130)W
- Operating voltage: 24 V DC
- Time-saving installation and maintenance
- Further available versions*:
 - EMC Filter Fan (7F.70) and EMC Exhaust Filter (7F.07)
 - Filter Fan supplied in Reverse flow mode (7F.80)

* Product codes, see pages 8 & 11

7F.50.9.024.1020

- Operating voltage 24 V DC
- Air volume 24 m³/h
- Rated power 4 W
- Size 1

7F.50.9.024.2055

- Operating voltage 24 V DC
- Air volume 55 m³/h
- Rated power 9 W
- Size 2

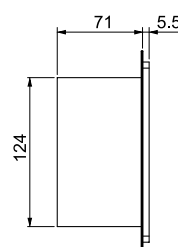
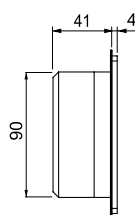
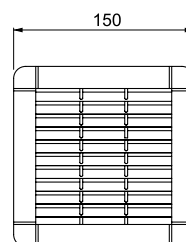
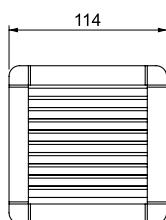
Note:

By reversing the fan motor, the air direction can be changed from "Inlet" Filter Fan mode to "Exhaust" Filter Fan mode** (except for the types 7F.50.8.xxx.4370, 7F.50.8.xxx.5500 and 7F.50.8.xxx.5630).

** Supplied in "Inlet" Filter Fan mode (Standard).

Fan data

Air volume (free flow)	m ³ /h	24	55
Air volume (with exhaust filter installed)	m ³ /h	14	40
Noise level	dB (A)	35	45
Life time at 40 °C	h	50000	50000

Electrical data

Operating voltage	V DC	24	24
Current consumption	A	0.16	0.37
Rated power	W	4	9

Other data

Housing, cover	Plastics according to UL94 V-0, light gray (RAL 7035)		
Filter mat (included)	G3 according to EN 779, filtering degree (80...90)%		
Filter material	Synthetic fibre with progressive construction, temperature resistant to 100 °C, self extinguishing, Class F1 (DIN 53438)		
Electrical connections/wire size	2-pole screw terminals / max. 2.5 mm ²		
Screw torque	Nm	0.8	
Ambient temperature range	°C	-10...+70	
Protection class	I		
Protection category according to EN 60529	IP54		

Approvals (according to type)

Filter Fan for electrical cabinets and enclosures 24 V DC versions

- Very low acoustic noise
- Minimal depth within enclosure
- Air volume (14...470)m³/h with Exhaust Filter installed in cabinet)
- Air volume (24...630)m³/h (free flow)
- Power consumption (4...130)W
- Operating voltage: 24 V DC
- Time-saving installation and maintenance
- Further available versions*:
 - EMC Filter Fan (7F.70) and EMC Exhaust Filter (7F.07)
 - Filter Fan supplied in Reverse flow mode (7F.80)

* Product codes, see pages 8 & 11

7F.50.9.024.3100



- Operating voltage 24 V DC
- Air volume 100 m³/h
- Rated power 9 W
- Size 3

7F.50.9.024.4230



- Operating voltage 24 V DC
- Air volume 230 m³/h
- Rated power 26 W
- Size 4

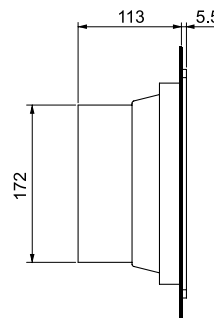
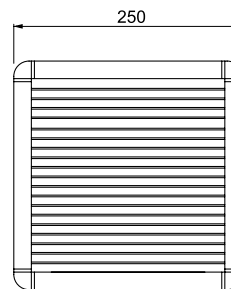
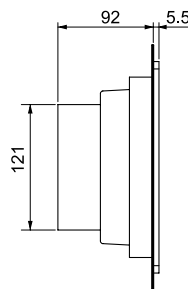
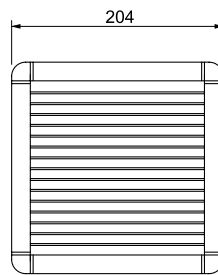

Note:

By reversing the fan motor, the air direction can be changed from "Inlet" Filter Fan mode to "Exhaust" Filter Fan mode** (except for the types 7F.50.8.xxx.4370, 7F.50.8.xxx.5500 and 7F.50.8.xxx.5630).

** Supplied in "Inlet" Filter Fan mode (Standard).

Fan data			
Air volume (free flow)	m ³ /h	100	230
Air volume (with exhaust filter installed)	m ³ /h	75	180
Noise level	dB (A)	45	61
Life time at 40 °C	h	50000	50000
Electrical data			
Operating voltage	V DC	24	24
Current consumption	A	0.37	1.08
Rated power	W	9	26
Other data			
Housing, cover		Plastics according to UL94 V-0, light gray (RAL 7035)	
Filter mat (included)		G3 according to EN 779, filtering degree (80...90)%	
Filter material		Synthetic fibre with progressive construction, temperature resistant to 100 °C, self extinguishing, Class F1 (DIN 53438)	
Electrical connections/wire size		2-pole screw terminals/max. 2.5 mm ²	
Screw torque	Nm	0.8	
Ambient temperature range	°C	-10...+70	
Protection class		I	
Protection category according to EN 60529		IP54	
Approvals (according to type)			

Ordering information

Example: Series 7F, Filter Fan for mounting in sidewalls, operating voltage 230 V AC, size 1, air volume 24 m³/h.

7 F . 5 0 . 8 . 2 3 0 . 1 0 2 0

Series

Type

50 = Filter Fan - for indoor use
70 = EMC Filter Fan - for indoor use
80 = Reverse flow Filter Fan - for indoor use

Supply version

8 = AC (50/60 Hz)
9 = DC

Operating voltage

024 = 24 V DC
120 = 120 V AC
230 = 230 V AC

Enclosure cut-out

1 = Size 1 (92^{+0.5} x 92^{+0.5}) mm
2 = Size 2 (125^{+1.0} x 125^{+1.0}) mm
3 = Size 3 (177^{+1.0} x 177^{+1.0}) mm
4 = Size 4 (224^{+1.0} x 224^{+1.0}) mm
5 = Size 5 (291^{+1.0} x 291^{+1.0}) mm

Air volume (free flow)

020 = 24 m³/h
055 = 55 m³/h
100 = 100 m³/h
230 = 230 m³/h
370 = 370 m³/h
500 = 500 m³/h
630 = 630 m³/h

G

Filter Fans - All versions

Standard versions	EMC versions	Reverse flow versions	
7F.50.8.120.1020	—	7F.80.8.120.1020	Filter Fan, Size 1
7F.50.8.120.2055	—	7F.80.8.120.2055	Filter Fan, Size 2
7F.50.8.120.3100	—	7F.80.8.120.3100	Filter Fan, Size 3
7F.50.8.120.4230	—	7F.80.8.120.4230	Filter Fan, Size 4
7F.50.8.120.4370	—	7F.80.8.120.4370	Filter Fan, Size 4
7F.50.8.120.5500	—	7F.80.8.120.5500	Filter Fan, Size 5
7F.50.8.120.5630	—	—	Filter Fan, Size 5
7F.50.8.230.1020	7F.70.8.230.1020	7F.80.8.230.1020	Filter Fan, Size 1
7F.50.8.230.2055	7F.70.8.230.2055	7F.80.8.230.2055	Filter Fan, Size 2
7F.50.8.230.3100	7F.70.8.230.3100	7F.80.8.230.3100	Filter Fan, Size 3
7F.50.8.230.4230	7F.70.8.230.4230	7F.80.8.230.4230	Filter Fan, Size 4
7F.50.8.230.4370	7F.70.8.230.4370	7F.80.8.230.4370	Filter Fan, Size 4
7F.50.8.230.5500	7F.70.8.230.5500	7F.80.8.230.5500	Filter Fan, Size 5
7F.50.8.230.5630	7F.70.8.230.5630	—	Filter Fan, Size 5
7F.50.9.024.1020	7F.70.9.024.1020	7F.80.9.024.1020	Filter Fan, Size 1
7F.50.9.024.2055	7F.70.9.024.2055	7F.80.9.024.2055	Filter Fan, Size 2
7F.50.9.024.3100	7F.70.9.024.3100	7F.80.9.024.3100	Filter Fan, Size 3
7F.50.9.024.4230	7F.70.9.024.4230	7F.80.9.024.4230	Filter Fan, Size 4

Note:

The technical features (air volume, dimensions and electrical parameters) for the Standard Filter Fans (7F.50), the EMC Filter Fans (7F.70) and the Reverse flow versions (7F.80) - are exactly the same.

7F.50.8.120.5630 has no UL approval. Other versions on request.

Exhaust Filter

The size of the Exhaust Filter should match the size of the Filter Fan to achieve the best ventilation within the cabinet

- Minimum depth within enclosure
- Time-saving installation and maintenance
- Further available versions*:
- EMC Exhaust Filters (7F.07)

* Product codes, see page 11

7F.05.0.000.1000



- For Filter Fans
7F.50.x.xxx.1020
- Size 1

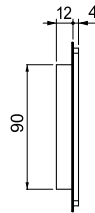
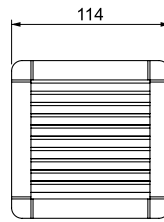

7F.05.0.000.2000



- For Filter Fans
7F.50.x.xxx.2055
- Size 2

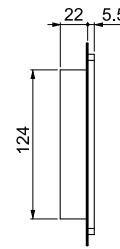
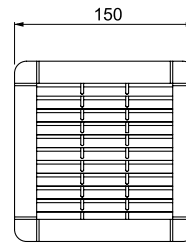

7F.05.0.000.3000



- For Filter Fans
7F.50.x.xxx.3100
- Size 3

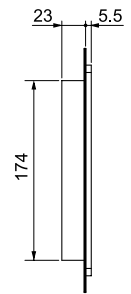
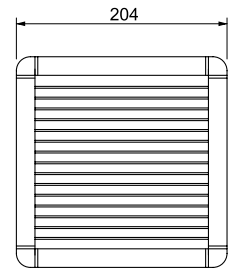

Other data

Housing, cover	Plastics according to UL94 V-0, light gray (RAL 7035)
Filter mat (included)	G3 according to EN 779, filtering degree (80...90)%
Filter material	Synthetic fibre with progressive construction, temperature resistant to +100 °C, self extinguishing, Class F1 (DIN 53438)
Protection category according to EN 60529	IP54
Approvals (according to type)	CE EAC cRU[®] US

Exhaust Filter

The size of the Exhaust Filter should match the size of the Filter Fan to achieve the best ventilation within the cabinet

- Minimum depth within enclosure
- Time-saving installation and maintenance
- Further available versions*:
- EMC Exhaust Filters (7F.07)

* Product codes, see page 11

7F.05.0.000.4000



- For Filter Fans
7F.50.x.xxx.4230 or
7F.50.8.xxx.4370
- Size 4

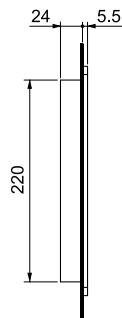
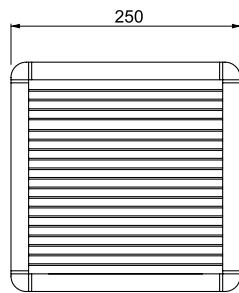

7F.05.0.000.5000



- For Filter Fans
7F.50.8.xxx.5500 or
7F.50.8.xxx.5630
- Size 5

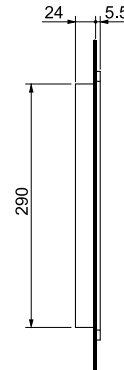
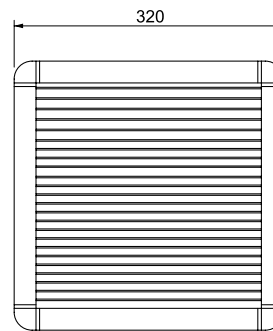

Other data

Housing, cover	Plastics according to UL94 V-0, light gray (RAL 7035)
Filter mat (included)	G3 according to EN 779, filtering degree (80...90)%
Filter material	Synthetic fibre with progressive construction, temperature resistant to +100 °C, self extinguishing, Class F1 (DIN 53438)
Protection category according to EN 60529	IP54

Approvals (according to type)



Ordering information

Example: Series 7F, Exhaust Filter for mounting in sidewalls, size 1.

7 F . 0 5 . 0 . 0 0 0 . 1 0 0 0

Series

Type

05 = Exhaust Filter - for indoor use

07 = EMC Exhaust Filter - for indoor use

Supply version

0 = Not applicable for Exhaust Filter

Operating voltage

000 = Not applicable for Exhaust Filter

Enclosure cut-out

1000 = Size 1 ($92^{+0.5} \times 92^{+0.5}$) mm

2000 = Size 2 ($125^{+1.0} \times 125^{+1.0}$) mm

3000 = Size 3 ($177^{+1.0} \times 177^{+1.0}$) mm

4000 = Size 4 ($224^{+1.0} \times 224^{+1.0}$) mm

5000 = Size 5 ($291^{+1.0} \times 291^{+1.0}$) mm

Exhaust Filter - All versions

Standard-versions	EMC - versions	
7F.05.0.000.1000	7F.07.0.000.1000	Exhaust Filter, Size 1
7F.05.0.000.2000	7F.07.0.000.2000	Exhaust Filter, Size 2
7F.05.0.000.3000	7F.07.0.000.3000	Exhaust Filter, Size 3
7F.05.0.000.4000	7F.07.0.000.4000	Exhaust Filter, Size 4
7F.05.0.000.5000	7F.07.0.000.5000	Exhaust Filter, Size 5

Components

Standard-Filter Fan	Standard-Exhaust Filter	EMC-Filter Fan	EMC-Exhaust Filter	Filter mat	Size
7F.50.8.xxx.1020	7F.05.0.000.1000	7F.70.8.230.1020	7F.07.0.000.1000	07F.15	1
7F.50.8.xxx.2055	7F.05.0.000.2000	7F.70.8.230.2055	7F.07.0.000.2000	07F.25	2
7F.50.8.xxx.3100	7F.05.0.000.3000	7F.70.8.230.3100	7F.07.0.000.3000	07F.35	3
7F.50.8.xxx.4230	7F.05.0.000.4000	7F.70.8.230.4230	7F.07.0.000.4000	07F.45	4
7F.50.8.xxx.4370	7F.05.0.000.4000	7F.70.8.230.4370	7F.07.0.000.4000	07F.45	4
7F.50.8.xxx.5500	7F.05.0.000.5000	7F.70.8.230.5500	7F.07.0.000.5000	07F.55	5
7F.50.8.xxx.5630	7F.05.0.000.5000	7F.70.8.230.5630	7F.07.0.000.5000	07F.55	5
7F.50.9.024.1020	7F.05.0.000.1000	7F.70.9.024.1020	7F.07.0.000.1000	07F.15	1
7F.50.9.024.2055	7F.05.0.000.2000	7F.70.9.024.2055	7F.07.0.000.2000	07F.25	2
7F.50.9.024.3100	7F.05.0.000.3000	7F.70.9.024.3100	7F.07.0.000.3000	07F.35	3
7F.50.9.024.4230	7F.05.0.000.4000	7F.70.9.024.4230	7F.07.0.000.4000	07F.45	4

Spare Filter mats	07F.15	07F.25	07F.35	07F.45	07F.55
Protection category	IP54				

Accessories



07F.80

Pressure compensation device, for pressure compensation in closed cabinets or enclosures	07F.80
Air interface area	cm ² 7
Mounting	PG 29 thread with union nut
Torque	Nm 5 (max. 10)
Material	plastic according to UL94-V0
Dimensions (diameter/depth)	mm 65.5/30.5
Mounting position	upper part of cabinet sidewalls
Ambient temperature	°C -45...+70
Protection category	IP55

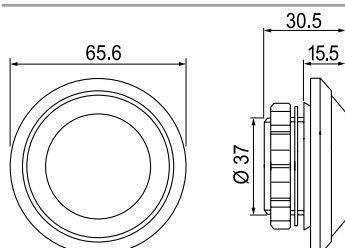

Unit package contains 2 pressure compensation devices

Mounting instructions for Filter Fans and Exhaust Filters

Mounting arrangement of Filter Fans and Exhaust Filters

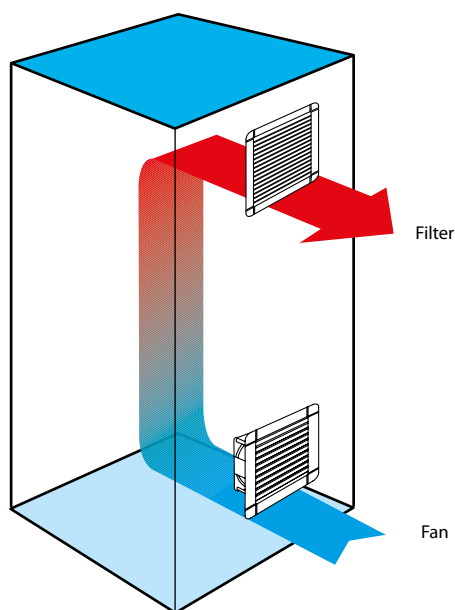

Drilling template and mounting cut-outs for Filter Fans and Exhaust Filter

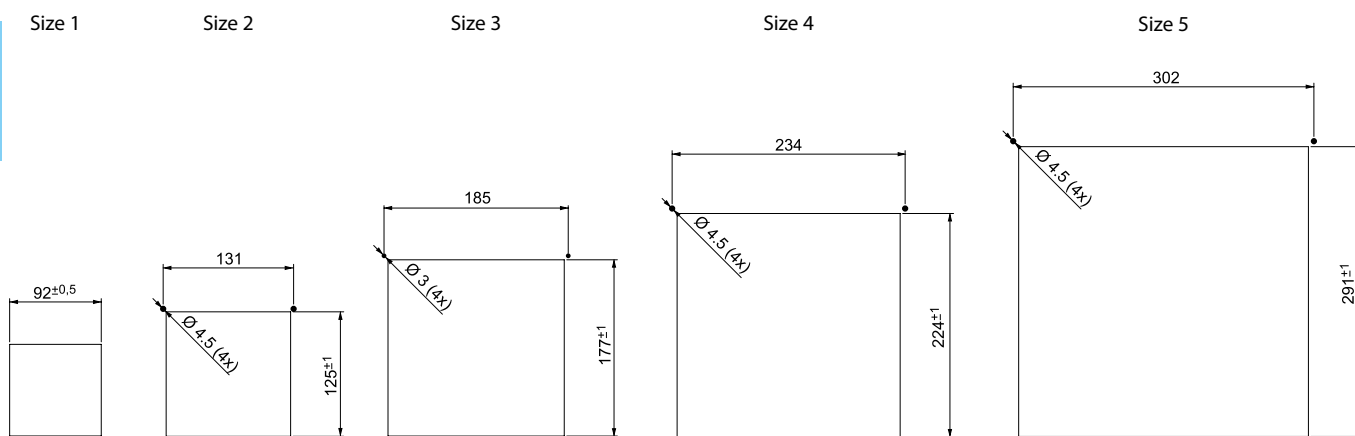

Mounting and maintenance

1. Make the panel cut-out according to the size of the Filter Fan or Exhaust Filter in the sidewall of the cabinet as appropriate.
A template of the panel cut-out is included in the packaging of the Filter Fan or Exhaust Filter.
2. Make the electrical connection.
3. Mount by simply snapping the side-located lugs on the Filter Fan or Exhaust Filter into the panel cut-out (without using screws for sidewall thickness of 1.2...2.4 mm).
At other thickness it is recommended to mount the Filter Fan by the screws supplied (for size 1, the template shows the mounting cut-out only).
4. When screws are needed for the mounting, remove the plastic cover and fix the Filter Fan with the 4 screws supplied.
Then insert the filter mat and snap the plastic cover to the mounting frame.
5. During maintenance or when replacing the filter mat remove the plastic cover, replace the filter mat and snap on the plastic cover.

Fan selection

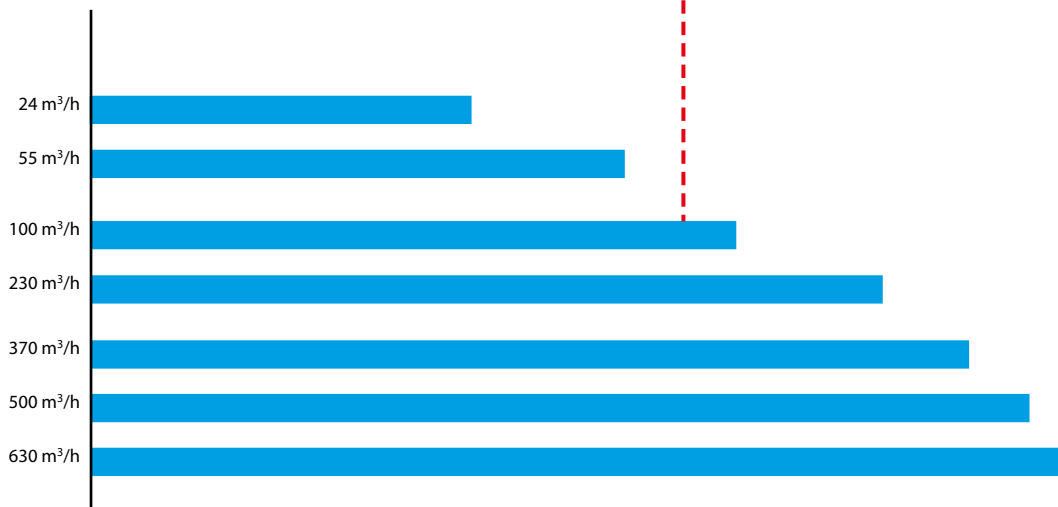
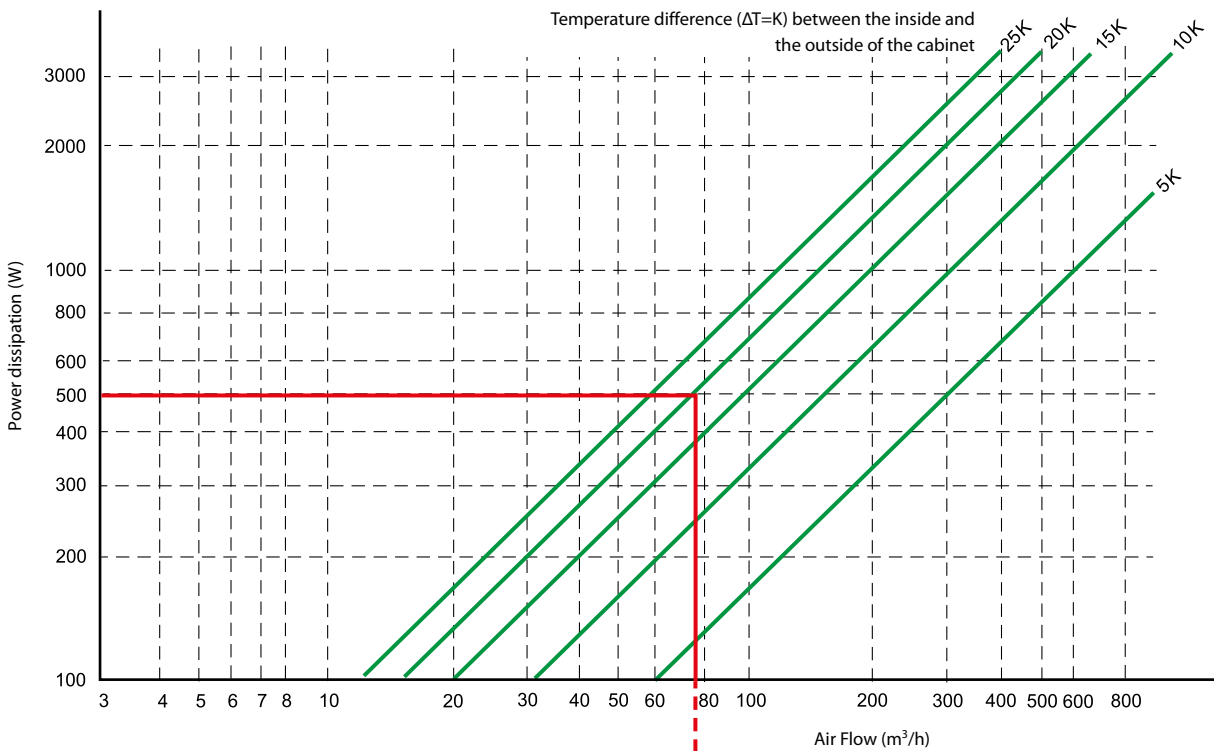

Example

First, estimate the power dissipated within the cabinet. Then calculate the maximum difference between the internal and external temperature (green lines) by considering the difference between the maximum permitted internal temperature (as dictated by the temperature rating of the enclosed components, or specification) and the maximum temperature expected outside the cabinet.

The projection onto the X axis, of the intersection between the power (watts) and the appropriate green line, corresponds to the air flow rate in m³/h required to meet the maximum internal temperature limit. Extending this line vertically to intersect with the blue horizontal lines, indicates the most appropriate model of 7F fan to be fitted to the cabinet to provide the requisite air flow.

The example above considers a cabinet with an internal thermal power dissipation of 500 W, and assumes the maximum temperature difference between the inside and the outside of the cabinet to be 20K. The required air flow can be seen to be a little less than 80 m³/h.

It is suggested that this is increased by 10% to allow for the affects of a dirty filter.

And so, it can be seen that models of the 7F with 100 m³/h flow rate will provide the proper dissipation of heat under these circumstances.

Application notes

Filter Fan

The ball-bearing axial fan housing is made of aluminium and the rotor is made of plastic or metal (depending on the type).

Filter classes

Within EN 779 are specified 9 filter classes, categorised into 4 coarse dust filters and 5 fine dust filters.

The coarse dust filters G1 - G4 are able to filter particles > 10 µm and the fine dust filters G5 - G9 are able to filter particles from (1...10)µm.

Filter classes	Example of particle	Particle size
G1 - G4 (EU1 - EU4)	Textile fibers, hair, sand, pollen, spores, insects, cement dust	> 10 µm
G5 - G9 (EU5 - EU9)	Pollen, spores, cement dust, tobacco smoke, oil smoke, soot	(1...10)µm

Filtering degree (Am)

The degree of filtering (Am) is the percentages of dust, by weight, that is caught and retained by the filter.

Filter mats

The quality of these filter mats has been independently tested, according EN 779 and branded after passing the test.

The filter mats are to filter class G3 and have an average filtering degree of (80...90)%.

Filter material

The filter material consists of a synthetic fiber with progressive construction which is moisture-resistant to 100% RH and temperature resistant to +100 °C.

According to the strict requirements of fire class F1, DIN 53438, these filter mats are self extinguishing.

Progressive construction at filter mats

The individual fibers of these filter mats are bonded by a special process to provide a progressive construction where the fiber size and spacing varies through the thickness of the filter mat.

This means that coarse dust particles are caught early and fine dust later through the thickness of the mat. In this way the entire depth of the filter mat is used.

Flammability class of the housing and the cover

The plastic materials used comply with flammability class V-0, according UL94.

EMC Filter Fans and EMC Exhaust Filters

The plastic mounting frame of the EMC Filter Fans (7F.70) and EMC Exhaust Filters (7F.07) are sprayed with a conductive (metallic) paint.

The gasket located on the mounting frame, for sealing the Filter Fan or Exhaust Filter in the cabinet is also metalised.

In addition; located at the EMC Filter Fan between the metalized mounting frame and the filter mat, is a metal grid.

Therefore, between the metal parts of the Filter Fan and the metal cabinet, there is a conductive connection.

Filter Fan in "reverse flow" version

As supplied, the standard Filter Fan is in "Draw-In"- mode, which means that cool air is filtered and drawn into the cabinet. In some cases it may be required that the warm air is blown out of the cabinet.

In which case it is possible to get Filter Fans in "Exhaust Filter" mode version (7F.80).

Mounting of the pressure compensation device

In sealed cabinets and enclosures the internal pressure can vary due to changes in temperature. The pressure compensation device (07F.80) will relieve this internal/external pressure differential whilst maintaining a high level of protection - preventing the ingress of dust and moisture into the cabinet or the enclosure. The pressure compensation device is approved for use in cabinets and enclosures according to DIN EN 62208.

Drill a hole Ø 37^{+1.0} mm in the housing wall and fix the pressure compensation device with the accompanying nut. It is important to ensure that the sealing ring is located on the outside. To ensure optimum pressure balance, it is recommended to fit 2 pressure compensation device at the upper sides of the cabinet or enclosure.



finder[®]
SWITCH TO THE FUTURE

Modular timers 1 - 6 - 8 - 16 A



Building automation



Elevators and lifts



Automation for blinds, grilles and shutters



Hoists and cranes



Panels for electrical distribution



Door and gate openers



80
SERIES

Multi-function and mono-function timer range

80.01 - Multi-function & multi-voltage

80.11 - On-delay, multi-voltage

- 17.5 mm wide
- Six time scales from 0.1 s to 24 h
- High input/output isolation
- 35 mm rail (EN 60715) mount
- "Blade + cross" - both flat blade and cross head screw drivers can be used to adjust the range and function selectors, the timing trimmer, and to disengage the rail mounting clip
- New multi-voltage versions with "PWM clever" technology

80.01



- Multi-voltage
- Multi-function

80.11



- Multi-voltage
- Mono-function

80.01 / 80.11
Screw terminal



- AI:** On-delay
DI: Interval
SW: Symmetrical flasher (starting pulse on)
BE: Off-delay with control signal
CE: On- and off-delay with control signal
DE: Interval with control signal on

AI: On-delay

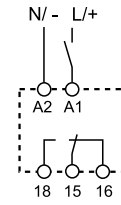
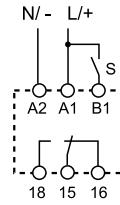
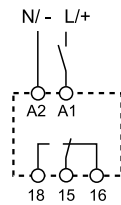

Wiring diagram
(without control signal)

Wiring diagram
(with control signal)

Wiring diagram
(without control signal)

FOR UL RATINGS SEE:

"General technical information" page V

For outline drawing see page 9

Contact specification

Contact configuration		1 CO (SPDT)	1 CO (SPDT)
Rated current/Maximum peak current	A	16/30	16/30
Rated voltage/ Maximum switching voltage	V AC	250/400	250/400
Rated load AC1	VA	4000	4000
Rated load AC15 (230 V AC)	VA	750	750
Single phase motor rating (230 V AC)	kW	0.55	0.55
Breaking capacity DC1: 30/110/220 V	A	16/0.3/0.12	16/0.3/0.12
Minimum switching load	mW (V/mA)	500 (10/5)	500 (10/5)
Standard contact material		AgNi	AgNi

Supply specification

Nominal voltage (U _N)	V AC (50/60 Hz)	12...240	24...240
	V DC	12...240	24...240
Rated power AC/DC	VA (50 Hz)/W	< 1.8/< 1	< 1.8/< 1
Operating range	V AC	10.8...265	16.8...265
	V DC	10.8...265	16.8...265

Technical data

Specified time range		(0.1...2)s, (1...20)s, (0.1...2)min, (1...20)min, (0.1...2)h, (1...24)h	
Repeatability	%	± 1	± 1
Recovery time	ms	100	100
Minimum control impulse	ms	50	—
Setting accuracy-full range	%	± 5	± 5
Electrical life at rated load in AC1	cycles	50 · 10 ³	50 · 10 ³
Ambient temperature range	°C	-10...+50	-10...+50
Protection category		IP 20	IP 20

Approvals (according to type)



Mono-function timer range**80.21 - Interval, multi-voltage****80.41 - Off-delay with control signal, multi-voltage****80.91 - Asymmetrical flasher, multi-voltage**

- 17.5 mm wide
- Six time scales from 0.1 s to 24 h
- High input/output isolation
- 35 mm rail (EN 60715) mount
- "Blade + cross" - both flat blade and cross head screw drivers can be used to adjust the range and function selectors, the timing trimmer, and to disengage the rail mounting clip
- New multi-voltage versions with "PWM clever" technology

80.21 / 80.41 / 80.91

Screw terminal



FOR UL RATINGS SEE:

"General technical information" page V

For outline drawing see page 9

Contact specification

		80.21	80.41	80.91
Contact configuration		1 CO (SPDT)	1 CO (SPDT)	1 CO (SPDT)
Rated current/Maximum peak current	A	16/30	16/30	16/30
Rated voltage/ Maximum switching voltage	V AC	250/400	250/400	250/400
Rated load AC1	VA	4000	4000	4000
Rated load AC15 (230 V AC)	VA	750	750	750
Single phase motor rating (230 V AC)	kW	0.55	0.55	0.55
Breaking capacity DC1: 30/110/220 V	A	16/0.3/0.12	16/0.3/0.12	16/0.3/0.12
Minimum switching load	mW (V/mA)	500 (10/5)	500 (10/5)	500 (10/5)
Standard contact material		AgNi	AgNi	AgNi

Supply specification

Nominal voltage (U _N)	V AC (50/60 Hz)	24...240	24...240	12...240
	V DC	24...240	24...240	12...240
Rated power AC/DC	VA (50 Hz)/W	< 1.8/< 1	< 1.8/< 1	< 1.8/< 1
Operating range	V AC	16.8...265	16.8...265	10.8...265
	V DC	16.8...265	16.8...265	10.8...265

Technical data

Specified time range		(0.1...2)s, (1...20)s, (0.1...2)min, (1...20)min, (0.1...2)h, (1...24)h		
Repeatability	%	± 1	± 1	± 1
Recovery time	ms	100	100	100
Minimum control impulse	ms	—	50	50
Setting accuracy-full range	%	± 5	± 5	± 5
Electrical life at rated load in AC1	cycles	50 · 10 ³	50 · 10 ³	50 · 10 ³
Ambient temperature range	°C	-10...+50	-10...+50	-10...+50
Protection category		IP 20	IP 20	IP 20

Approvals (according to type)**80.21**

- Multi-voltage
- Mono-function

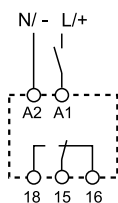
DI: IntervalWiring diagram
(without control signal)**80.41**

- Multi-voltage
- Mono-function

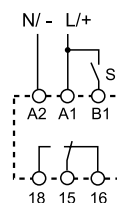
BE: Off-delay with control signalWiring diagram
(with control signal)**80.91**

- Multi-voltage
- Mono-function

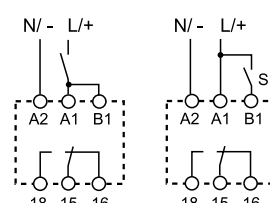
LI: Asymmetrical flasher
(starting pulse on)**LE:** Asymmetrical flasher (starting pulse on) with control signalWiring diagram
(without control signal)Wiring diagram
(with control signal)

Multi-function and multi-voltage solid-state output timer

- 17.5 mm wide
- Six time scales from 0.1 s to 24 h
- High input/output isolation
- 35 mm rail (EN 60715) mount
- Multi-voltage output (24...240 V AC/DC), independent from the input voltage
- "Blade + cross" - both flat blade and cross head screw drivers can be used to adjust the range and function selectors, the timing trimmer, and to disengage the rail mounting clip
- Multi-voltage input with "PWM clever" technology

80.71
Screw terminal



80.71



- Multi-voltage
- Multi-function

AI: On-delay
DI: Interval
SW: Symmetrical flasher (starting pulse on)
BE: Off-delay with control signal
CE: On- and off-delay with control signal
DE: Interval with control signal on

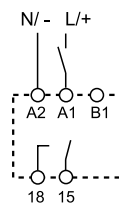

Wiring diagram
(without control signal)

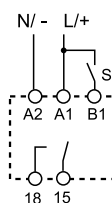

Wiring diagram
(with control signal)

For outline drawing see page 9

Output circuit

Contact configuration	1 NO (SPST-NO)	
Rated current	A	1
Rated voltage	V AC/DC	24...240
Switching voltage range	V AC/DC	19...265
Rated load AC15	A	1
Rated load DC1	A	1
Minimum switching current	mA	0.5
Max. "OFF-state" leakage current	mA	0.05
Max. "ON-state" voltage drop	V	2.8

Input circuit

Nominal voltage (U _N)	V AC (50/60 Hz)	24...240
	V DC	24...240
Rated power	VA (50 Hz)/W	1.3/1.3
Operating range	V AC	19...265
	V DC	19...265

Technical data

Specified time range	(0.1...2)s, (1...20)s, (0.1...2)min, (1...20)min, (0.1...2)h, (1...24)h	
Repeatability	%	± 1
Recovery time	ms	100
Minimum control impulse	ms	50
Setting accuracy-full range	%	± 5
Electrical life	cycles	100 · 10 ⁶
Ambient temperature range	°C	-20...+50
Protection category	IP 20	

Approvals (according to type)



Mono-function timer range**80.61 - Power off-delay (True off-delay), multi-voltage****80.82 - Star-delta, multi-voltage**

- 17.5 mm wide
- Rotary range selector, and timing trimmer
- Four time scales from 0.05s to 180 s (type 80.61)
- Six time scales from 0.1 s to 20min (type 80.82)
- High input/output isolation
- 35 mm rail (EN 60715) mount

80.61 / 80.82
Screw terminal

FOR UL RATINGS SEE:

"General technical information" page V

For outline drawing see page 9

Contact specification

Contact configuration		1 CO (SPDT)	2 NO (DPST-NO)
Rated current/Maximum peak current	A	8/15	6/10
Rated voltage/ Maximum switching voltage	V AC	250/400	250/400
Rated load AC1	VA	2000	1500
Rated load AC15 (230 V AC)	VA	400	300
Single phase motor rating (230 V AC)	kW	0.3	—
Breaking capacity DC1: 30/110/220 V	A	8/0.3/0.12	6/0.2/0.12
Minimum switching load	mW (V/mA)	300 (5/5)	500 (12/10)
Standard contact material		AgNi	AgNi

Supply specification

Nominal voltage (U _N)	V AC (50/60 Hz)	24...240	24...240
	V DC	24...220	24...240
Rated power AC/DC	VA (50 Hz)/W	< 0.6/< 0.6	< 1.3/< 0.8
Operating range	V AC	16.8...265	16.8...265
	V DC	16.8...242	16.8...265

Technical data

Specified time range		(0.05...2)s, (1...16)s, (8...70)s, (50...180)s	(0.1...2)s, (1...20)s, (0.1...2)min, (1...20)min
Repeatability	%	± 1	± 1
Recovery time	ms	—	100
Minimum control impulse	ms	500 (A1-A2)	—
Setting accuracy-full range	%	± 5	± 5
Electrical life at rated load in AC1	cycles	100 · 10 ³	60 · 10 ³
Ambient temperature range	°C	-10...+50	-10...+50
Protection category		IP 20	IP 20

Approvals (according to type)**80.61**

- Multi-voltage
- Mono-function

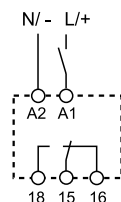
BI: Power off-delay (True off-delay)Wiring diagram
(without control signal)**80.82**

- Multi-voltage
- Mono-function
- Transfer time can be regulated (0.05...1)s

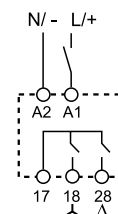
SD: Star-deltaWiring diagram
(without control signal)

Multi-function and multi-voltage

- 17.5 mm wide
- Six time scales from 0.1 s to 24 h
- High input/output isolation
- 35 mm rail (EN 60715) mount
- "Blade + cross" - both flat blade and cross head screw drivers can be used to adjust the range and function selectors, the timing trimmer, and to disengage the rail mounting clip
- New multi-voltage versions with "PWM clever" technology

80.51.0.240.0000
Screw terminal

80.51..0.240.P000
Push-in terminal



FOR UL RATINGS SEE:

"General technical information" page V

For outline drawing see page 9

Contact specification

Contact configuration		1 CO (SPDT)
Rated current/Maximum peak current	A	8/16
Rated voltage/ Maximum switching voltage	V AC	250/400
Rated load AC1	VA	2000
Rated load AC15 (230 V AC)	VA	400
Single phase motor rating (230 V AC)	kW	0.3
Breaking capacity DC1: 30/110/220 V	A	8/0.3/0.12
Minimum switching load	mW (V/mA)	500 (10/5)
Standard contact material		AgNi

Supply specification

Nominal voltage (U _N)	V AC (50/60 Hz)	24...240
	V DC	24...240
Rated power AC/DC	VA (50 Hz)/W	< 1.8/< 1
Operating range	V AC	17...265
	V DC	17...265

Technical data

Specified time range		(0.1...2)s, (1...20)s, (0.1...2)min, (1...20)min, (0.1...2)h, (1...24)h
Repeatability	%	± 1
Recovery time	ms	≤ 50
Minimum control impulse	ms	50
Setting accuracy-full range	%	± 5
Electrical life at rated load in AC1	cycles	100 · 10 ³
Ambient temperature range	°C	-10...+50
Protection category		IP 20

Approvals (according to type)

NEW 80.51



- Multi-voltage (24...240) V AC/DC
- Multi-function

- AI:** On-delay
- DI:** Interval
- SW:** Symmetrical flasher (starting pulse on)
- BE:** Off-delay with control signal
- CE:** On- and off-delay with control signal
- DE:** Interval with control signal on

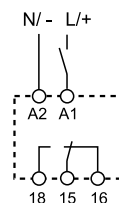

Wiring diagram
(without control signal)

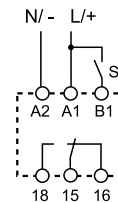

Wiring diagram
(with control signal)

Ordering information

Example: 80 series, modular timers, 1 CO (SPDT) - 16 A, supply rated at (12...240)V AC/DC.

8 0 . 0 1 . 0 . 2 4 0 . 0 0 0 0

Series

Type

- 0 = Multi-function (AI, DI, SW, BE, CE, DE)
- 1 = On-delay (AI)
- 2 = Interval (DI)
- 4 = Off-delay with control signal (BE)
- 5 = Multi-function (AI, DI, SW, BE, CE, DE)
- 6 = Power off-delay (True off-delay) (BI)
- 7 = Multi-function with solid state output (AI, DI, SW, BE, CE, DE)
- 8 = Star-delta (SD)
- 9 = Asymmetrical flasher (LI, LE)

Versions

- 0 = Standard
- P = Push-in (only for 80.51)

Supply voltage

- 240 = (12...240)V AC/DC (80.01, 80.91)
- 240 = (24...240)V AC/DC (80.11, 80.21, 80.41, 80.51, 80.71, 80.82)
- 240 = (24...240)V AC, (24...220)V DC (80.61)

Supply version

- 0 = AC (50/60 Hz)/DC

No. of poles

- 1 = 1 CO (SPDT)
- 1 = 1 NO (SPST-NO), type 80.71 only
- 2 = 2 NO (DPST-NO), type 80.82 only

Technical data

Insulation

			80.01/11/21/41/51/82/91	80.61	80.71
Dielectric strength	between input and output circuit	V AC	4000	2500	2500
	between open contacts	V AC	1000	1000	—
Insulation (1.2/50 μs) between input and output		kV	6	4	4

EMC specifications

Type of test		Reference standard	80.01/11/21/41/61/71/91	80.51/82
Electrostatic discharge	contact discharge	EN 61000-4-2	4 kV	4 kV
	air discharge	EN 61000-4-2	8 kV	8 kV
Radio-frequency electromagnetic field (80 ÷ 1000 MHz)		EN 61000-4-3	10 V/m	10 V/m
Fast transients (burst) (5-50 ns, 5 kHz) on Supply terminals		EN 61000-4-4	4 kV	4 kV
Surges (1.2/50 μs) on Supply terminals	common mode	EN 61000-4-5	4 kV	4 kV
	differential mode	EN 61000-4-5	4 kV	4 kV
	common mode	EN 61000-4-5	4 kV	4 kV
	differential mode	EN 61000-4-5	4 kV	4 kV
Radio-frequency common mode (0.15 ÷ 80 MHz) on Supply terminals		EN 61000-4-6	10 V	10 V
Radiated and conducted emission		EN 55022	class B	class A

Other data

Current absorption on signal control (B1)			< 1 mA
Power lost to the environment	without contact current	W	1.4
	with rated current	W	3.2

Terminals

			Screw terminals	Push-in terminals
Wire strip length	mm		10	10
 Screw torque	Nm		0.8	—
Min. wire size			solid cable	solid cable
	mm ²		0.5	0.75
	AWG		20	18
Max. wire size			solid cable	solid cable
	mm ²		1 x 6 / 2 x 4	1 x 1.5 / 2 x 1.5
	AWG		1 x 10 / 2 x 12	1 x 16 / 2 x 16
Min. wire size			stranded cable	stranded cable
	mm ²		0.5	0.75
	AWG		20	18
Max. wire size			stranded cable	stranded cable
	mm ²		1 x 4 / 2 x 2.5	1 x 2.5 / 2 x 2.5
	AWG		1 x 12 / 2 x 14	1 x 14 / 2 x 14

Outline drawings

80.01/80.51
Screw terminal

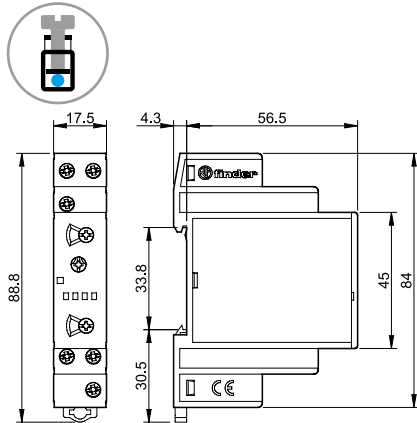

80.51
Push-in terminal

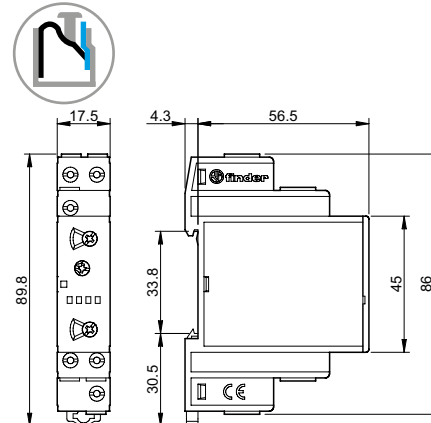

80.11/80.21/80.61
Screw terminal

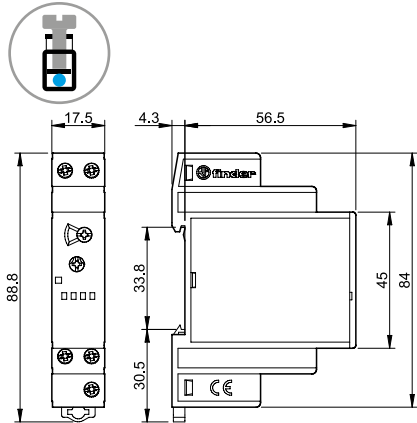

80.41
Screw terminal

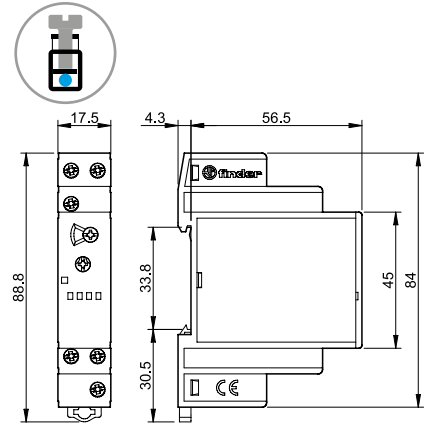

80.91
Screw terminal

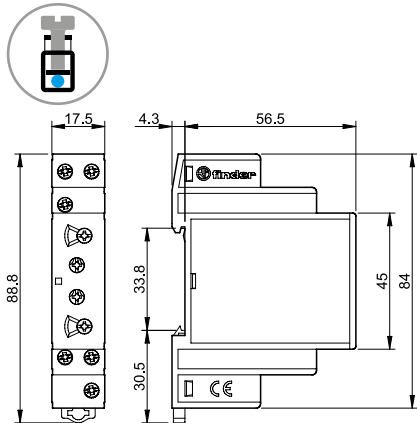

80.71
Screw terminal

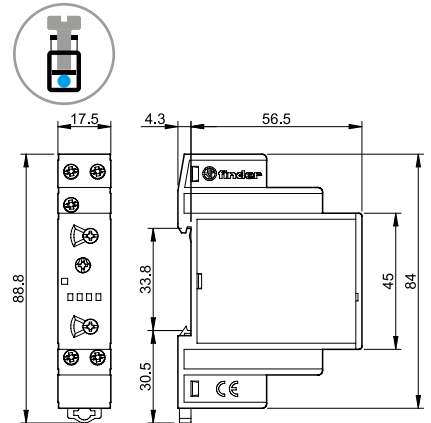

80.82
Screw terminal

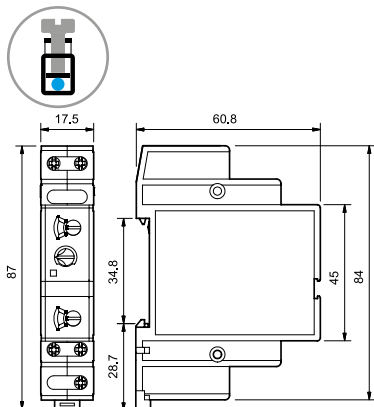

Functions

U = Supply voltage

S = Signal switch

= Output contact

LED*	Supply voltage	NO output contact	Contacts	
			Open	Closed
	OFF	Open	15 - 18	15 - 16
	ON	Open	15 - 18	15 - 16
	ON	Open (Timing in Progress)	15 - 18	15 - 16
	ON	Closed	15 - 16	15 - 18

* The LED on type 80.61 is illuminated only when the supply voltage is applied to the timer; during the timing period the LED is not illuminated.

Wiring diagram

Without control signal

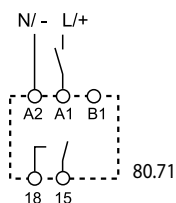
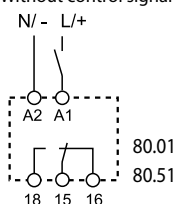

Without control signal = Start via contact in supply line (A1).

With control signal = Start via contact into control terminal (B1).

Type
80.01
80.51
80.71

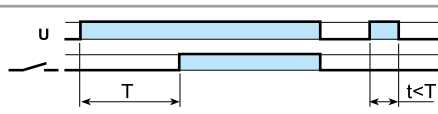

(A1) On-delay.

Apply power to timer. Output contacts transfer after preset time has elapsed. Reset occurs when power is removed.

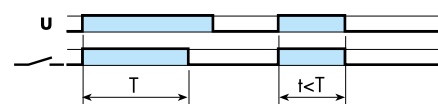

(DI) Interval.

Apply power to timer. Output contacts transfer immediately. After the preset time has elapsed, contacts reset.

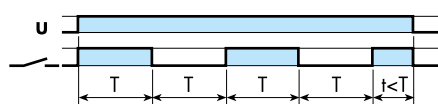

(SW) Symmetrical flasher (starting pulse on).

Apply power to timer. Output contacts transfer immediately and cycle between ON and OFF for as long as power is applied. The ratio is 1:1 (time on = time off).

H

With control signal

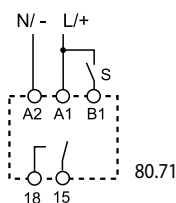
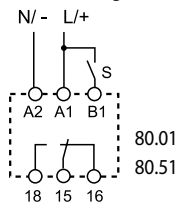

80.01
80.51
80.71

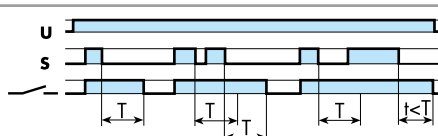

(BE) Off-delay with control signal.

Power is permanently applied to the timer. The output contacts transfer immediately on closure of the Signal Switch (S). Opening the Signal Switch initiates the preset delay, after which time the output contacts reset.

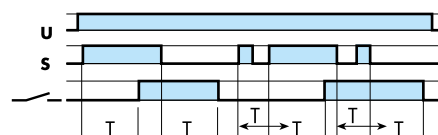

(CE) On- and off-delay with control signal.

Power is permanently applied to the timer. Closing the Signal Switch (S) initiates the preset delay, after which time the output contacts transfer. Opening the Signal switch initiates the same preset delay, after which time the output contacts reset.

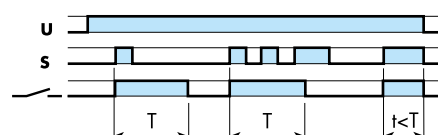

(DE) Interval with control signal on.

Power is permanently applied to the timer. On momentary or maintained closure of Signal Switch (S), the output contacts transfer, and remain so for the duration of the preset delay, after which they reset.

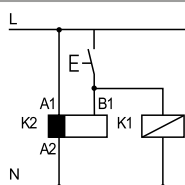

NOTE: The function must be set before energising the timer.

• Possible to control an external load, such as another relay coil or timer, connected to the control signal terminal B1.

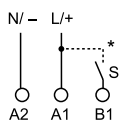

* With DC supply, positive polarity has to be connected to B1 terminal (according to EN 60204-1).

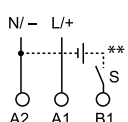

** A voltage other than the supply voltage can be applied to the command Start (B1), example:

A1 - A2 = 230 V AC
B1 - A2 = 12 V DC

Functions

Wiring diagram

<p>Without control signal</p> <p>80.11/21/61</p> <p>80.82</p>	<p>Type 80.11</p> <p>80.21</p> <p>80.61</p> <p>80.82</p>	<p>(AI) On-delay. Apply power to timer. Output contacts transfer after preset time has elapsed. Reset occurs when power is removed.</p> <p>(DI) Interval. Apply power to timer. Output contacts transfer immediately. After the preset time has elapsed, contacts reset.</p> <p>(BI) Power off-delay (True off-delay). Apply power to timer (minimum 500 ms). Output contacts transfer immediately. Removal of power initiates the preset delay, after which time the output contacts reset.</p> <p>(SD) Star-delta. Apply power to timer. The star contact (Λ) closes immediately. After preset delay has elapsed the star contact (Λ) resets. After a further transfer time variable from (0.05...1)s the delta contact (Δ) closes and remains in that position, until reset on power off.</p>	
<p>With control signal</p> <p>80.41</p>	<p>80.41</p>		<p>(BE) Off-delay with control signal. Power is permanently applied to the timer. The output contacts transfer immediately on closure of the Signal Switch (S). Opening the Signal Switch initiates the preset delay, after which time the output contacts reset.</p>
<p>Without control signal</p> <p>80.91</p> <p>With control signal</p> <p>80.91</p>	<p>80.91</p>	<p>(LI) Asymmetrical flasher (starting pulse on). Apply power to timer. Output contacts transfer immediately and cycle between ON and OFF for as long as power is applied. The ON (T₁) and OFF (T₂) times are independently adjustable.</p> <p>(LE) Asymmetrical flasher (starting pulse on) with control signal Power is permanently applied to the timer. Closing Signal Switch (S) causes the output contacts to transfer immediately and cycle between ON (T₁) and OFF (T₂), until opened.</p>	

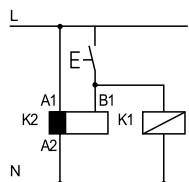

• Possible to control an external load, such as another relay coil or timer, connected to the control signal terminal B1.

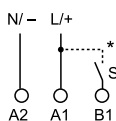

* With DC supply, positive polarity has to be connected to B1 terminal (according to EN 60204-1).

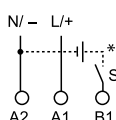

** A voltage other than the supply voltage can be applied to the command Start (B1), example:

A1 - A2 = 230 V AC

B1 - A2 = 12 V DC

Accessories



020.24

Sheet of marker tags, for types 80.82, plastic, 24 tags, 9 x 17 mm

020.24

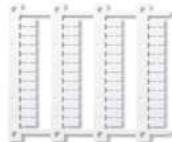

060.48

Sheet of marker tags (CEMBRE Thermal transfer printers) for relays types 80.01/11/21/41/51/61/71 (48 tags), 6 x 12 mm

060.48



finder[®]
SWITCH TO THE FUTURE

Modular timers 16 A



Control panels



Milk processing plant



Punches, cleaners, planers and sanders



Hoists and cranes



Shipyards



Door and gate openers



81
SERIES

Multi-function and multi-voltage timer

- One module 17.5 mm wide housing
- Seven functions (4 with supply start and 3 with control signal)
- Additional Reset function
- Six time ranges from 0.1 s to 10 h
- 35 mm rail (EN 60715) mounting

81.01

Screw terminal

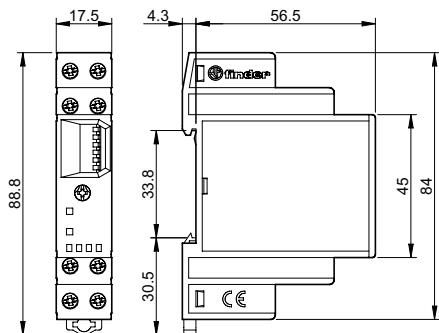

81.01



- Multi-voltage (DC non polarized)
- Multi-function
- 35 mm rail (EN 60715) mounting

- AI:** On-delay
- DI:** Interval
- SW:** Symmetrical flasher (starting pulse on)
- SP:** Symmetrical flasher (starting pulse off)
- BE:** Off-delay with control signal
- DE:** Interval with control signal on
- EEb:** Interval with control signal off

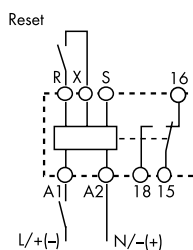

Wiring diagram
(supply START)

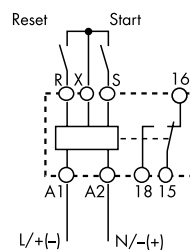

Wiring diagram
(control signal)

Contact specification

Contact configuration		1 CO (SPDT)
Rated current/Maximum peak current	A	16/30
Rated voltage/ Maximum switching voltage	V AC	250/400
Rated load AC1	VA	4000
Rated load AC15 (230 V AC)	VA	750
Single phase motor rating (230 V AC)	kW	0.55
Breaking capacity DC1: 30/110/220 V	A	16/0.3/0.12
Minimum switching load	mW (V/mA)	500 (10/5)
Standard contact material		AgCdO

Supply specification

Nominal voltage (U _N)	V AC (50/60 Hz)	12...230
	V DC	12...230 (non polarized)
Rated power AC/DC	VA (50 Hz)/W	< 2/< 2
Operating range	V AC	10.8...250
	V DC	10.8...250

Technical data

Specified time range		(0.1...1)s, (1...10)s, (10...60)s, (1...10)min, (10...60)min, (1...10)h
Repeatability	%	± 1
Recovery time	ms	≤ 50
Minimum control impulse	ms	50
Setting accuracy-full range	%	± 5
Electrical life at rated load in AC1	cycles	100 · 10 ³
Ambient temperature range	°C	-10...+50
Protection category		IP 20

Approvals (according to type)



Ordering information

Example: 81 series, modular timer multi-voltage, 1 CO (SPDT) - 16 A, supply rated at (12...230)V AC/DC.

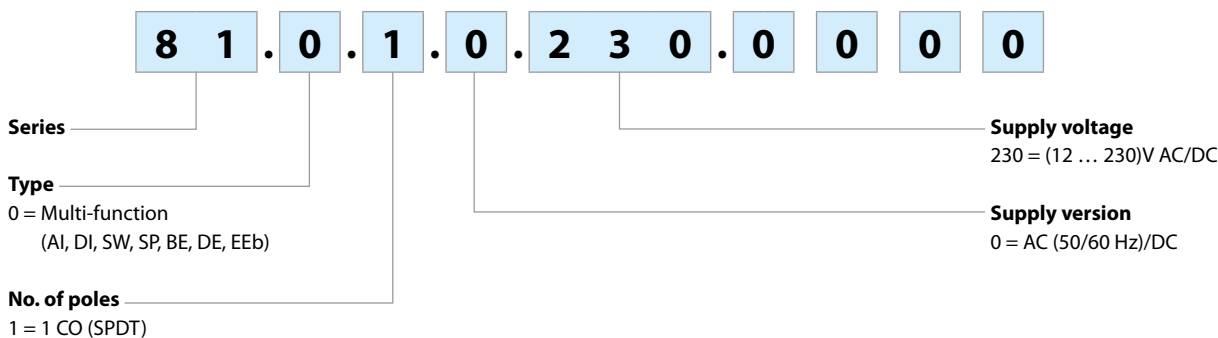

Technical data

EMC specifications

Type of test		Reference standard	
Electrostatic discharge	contact discharge	EN 61000-4-2	4 kV
	air discharge	EN 61000-4-2	8 kV
Radio-frequency electromagnetic field (80 ÷ 1000 MHz)		EN 61000-4-3	10 V/m
Fast transients (burst) (5-50 ns, 5 kHz) on Supply terminals		EN 61000-4-4	4 kV
Surges (1.2/50 µs) on Supply terminals	common mode	EN 61000-4-5	4 kV
	differential mode	EN 61000-4-5	4 kV
Radio-frequency common mode (0.15 ÷ 80 MHz) on Supply terminals		EN 61000-4-6	10 V
Radiated and conducted emission		EN 55022	class A

Other data

Current absorption on signal control (B1)		< 1 mA (S-X)	< 1 mA (R-X)	
Voltage potential on the input terminal R - X and S - X		Not galvanic separation from the supply voltage on A1 - A2		
Power lost to the environment	without contact current	W	1.3	
	with rated current	W	3.2	
Screw torque		Nm	0.8	
Max. wire size		solid cable	stranded cable	
		mm ²	1 x 6 / 2 x 4	1 x 4 / 2 x 2.5
		AWG	1 x 10 / 2 x 12	1 x 12 / 2 x 14

Time range setting

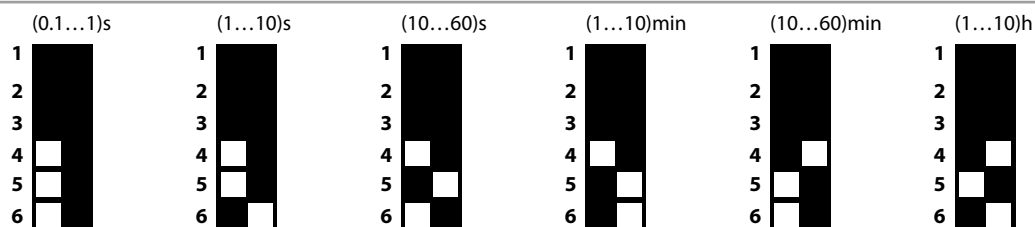

NOTE: time range and function must be set before energising the timer.

Functions

- U** = Supply voltage
- S** = Signal switch
- R** = Reset
- = Output contact

LED (green)	LED (red)	Supply voltage	NO output contact	Contacts	
				Open	Closed
		OFF	Open	15 - 18	15 - 16
		ON	Open	15 - 18	15 - 16
		ON	Closed	15 - 16	15 - 18

Supply Start = Start via contact in supply line (A1).
Control signal = Start via contact into control terminal (X-S).

Wiring diagram

Supply START

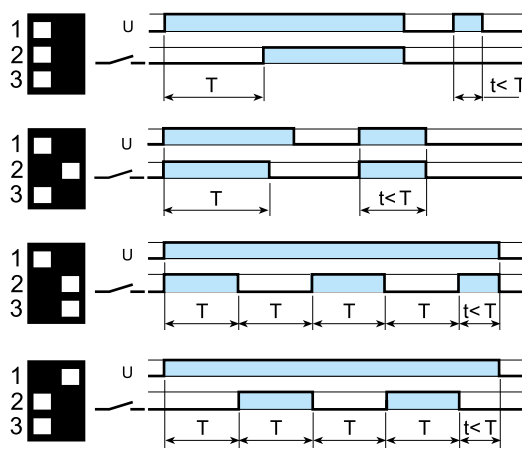
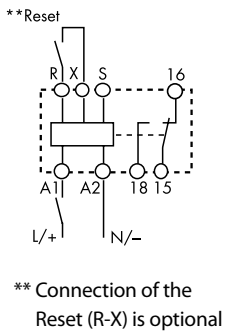

- (AI) On-delay.**
Apply power to timer. Output contacts transfer after preset time has elapsed. Reset occurs when power is removed.
- (DI) Interval.**
Apply power to timer. Output contacts transfer immediately. After the preset time has elapsed, contacts reset.
- (SW) Symmetrical flasher (starting pulse on).**
Apply power to timer. Output contacts transfer immediately and cycle between ON and OFF for as long as power is applied. The ratio is 1:1 (time on = time off).
- (SP) Symmetrical flasher (starting pulse off).**
Apply power to timer. First transfer of contact occurs after preset time has elapsed. The timer now cycles between OFF and ON as long as power is applied. The ratio is 1:1 (time on = time off).

Control signal

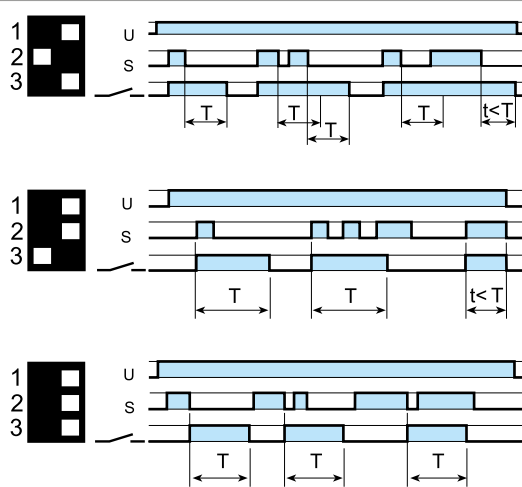
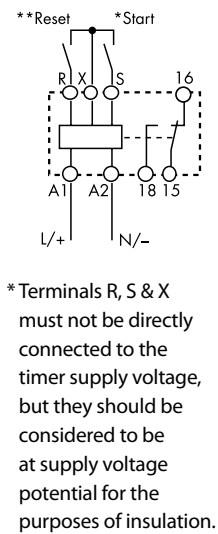

- (BE) Off-delay with control signal.**
Power is permanently applied to the timer. The output contacts transfer immediately on closure of the Signal Switch (S). Opening the Signal Switch initiates the preset delay, after which time the output contacts reset.
- (DE) Interval with control signal on.**
Power is permanently applied to the timer. On momentary or maintained closure of Signal Switch (S), the output contacts transfer, and remain so for the duration of the preset delay, after which they reset.
- (EEb) Interval with control signal off.**
Power is permanently applied to the timer. On opening of the Signal Switch (S) the output contacts transfer, and remain so for the duration of the preset delay, after which they reset.

RESET function (R)

For each and every function and time range, the timer is immediately reset when the reset switch is closed.

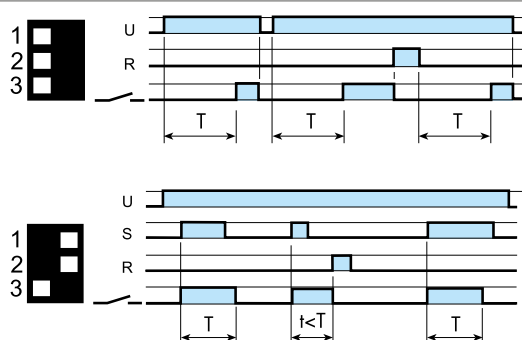

- Example:
Supply START; ON delay function
Closing the external reset switch immediately resets the timer. Opening the reset switch re-initiates the timing function.
- Example:
Control signal; ON pulse function.
Closing the external reset switch terminates the interval time and resets the timer. To re-start, it is necessary to open the reset switch, before closing the control signal contact.

Accessories



019.01

Identification tag, for type 81.01, plastic, 1 tag, 17 x 25.5 mm

019.01

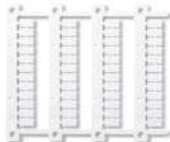

060.48

Sheet of marker tags (CEMBRE Thermal transfer printers) for type 81.01, plastic,
48 tags, 6 x 12 mm

060.48



finder[®]
SWITCH TO THE FUTURE

Modular timers 8 - 12 - 16 A

83
SERIES



Panels for electrical
distribution



Automatic
car-washes



Packaging
machines



Pump control



Industrial
refrigeration



Fountains

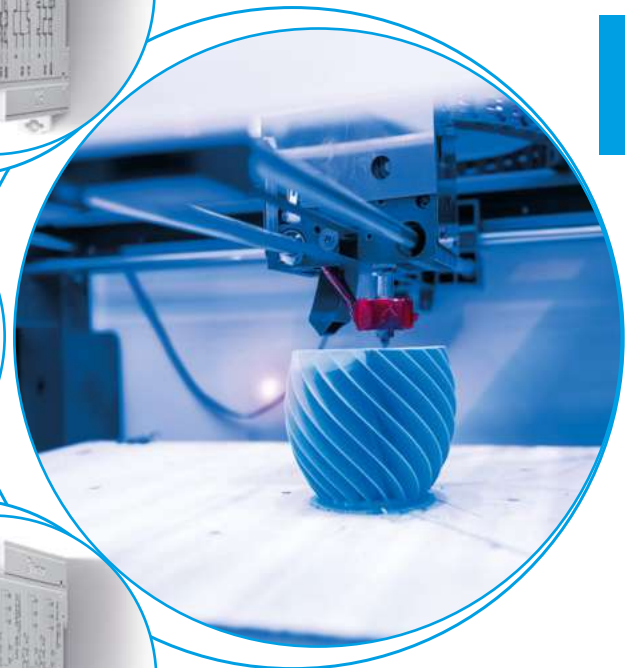

Multi-function timer range

Type 83.01

- Multi-function & multi-voltage
- 1 Pole

Type 83.02

- Multi-function & multi-voltage
- 2 Pole (timed + instantaneous options), external time setting potentiometer option

Type 83.52

- Multi-function & multi-voltage
- 2 Pole (timed + instantaneous options), external time setting potentiometer option, pause function option

- 22.5 mm wide
- Eight time scales from 0.05 s to 10 days
- High input/output isolation
- Wide supply range (24...240)V AC/DC
- 35 mm rail (EN 60715) mount
- "Blade + cross" - both flat blade and cross head screw drivers can be used to adjust the range and function selectors, the timing trimmer, and to disengage the rail mounting clip
- Multi-voltage versions with "PWM clever" technology
- Complies with EN 45545-2:2013 (protection against fire of materials), EN 61373 (resistance against random vibrations and shock, Category 1, Class B), EN 50155 (resistance to temperature and humidity, T1 class)

For outline drawing see page 7

Contact specification

Contact configuration		1 CO (SPDT)	2 CO (DPDT)	2 CO (DPDT)
Rated current/Maximum peak current	A	16/30	12/30	12/30
Rated voltage/ Maximum switching voltage	V AC	250/400	250/400	250/400
Rated load AC1	VA	4000	3000	3000
Rated load AC15 (230 V AC)	VA	750	750	750
Single phase motor rating (230 V AC)	kW	0.5	0.5	0.5
Breaking capacity DC1: 30/110/220 V	A	16/0.3/0.12	12/0.3/0.12	12/0.3/0.12
Minimum switching load	mW (V/mA)	300 (5/5)	300 (5/5)	300 (5/5)
Standard contact material		AgNi	AgNi	AgNi

Supply specification

Nominal voltage (U _N)	V AC (50/60 Hz)	24...240	24...240	24...240
	V DC	24...240	24...240	24...240
Rated power AC/DC	VA (50 Hz)/W	< 1.5/< 2	< 2/< 2	< 2/< 2
Operating range	V AC	16.8...265	16.8...265	16.8...265
	V DC	16.8...265	16.8...265	16.8...265

Technical data

Specified time range		(0.05...1)s, (0.5...10)s, (0.05...1)min, (0.5...10)min, (0.05...1)h, (0.5...10)h, (0.05...1)d, (0.5...10)d		
Repeatability	%	± 1	± 1	± 1
Recovery time	ms	200	200	200
Minimum control impulse	ms	50	50	50
Setting accuracy-full range	%	± 5	± 5	± 5
Electrical life at rated load in AC1	cycles	50 · 10 ³	60 · 10 ³	60 · 10 ³
Ambient temperature range	°C	-20...+60	-20...+60	-20...+60
Protection category		IP 20	IP 20	IP 20

Approvals (according to type)



	83.01	83.02	83.52
• Multi-voltage • Multi-function	• Multi-voltage • Multi-function • Timing can be regulated using ext. Potentiometer • 2 timed contacts or 1 timed + 1 instantaneous contact	• Multi-voltage • Multi-function • Timing can be regulated using ext. Potentiometer • 2 timed contacts or 1 timed + 1 instantaneous contact • 3 functions with pause option	
AI: On-delay DI: Interval GI: Pulse delayed SW: Symmetrical flasher (starting pulse on) BE: Off-delay with control signal CE: On- and off-delay with control signal DE: Interval with control signal on WD: Watchdog (Retriggerable interval with control signal on)	AI: On-delay DI: Interval GI: Pulse delayed SW: Symmetrical flasher (starting pulse on) BE: Off-delay with control signal CE: On- and off-delay with control signal DE: Interval with control signal on WD: Watchdog (Retriggerable interval with control signal on)	AE: On-delay with control signal GE: Pulse delayed with control signal on IT: Timing step FE: Interval with control signal on and off EEa: Interval with control signal off (retriggerable) DEp: Interval with control signal on and pause signal BEp: Off-delay with control signal and pause signal SHp: "Shower" function	

Mono-function timer range**Type 83.11**

- ON-delay, multi-voltage

Type 83.21

- Interval, multi-voltage

Type 83.41

- Off-delay with control signal, multi-voltage

- 1 Pole
- 22.5 mm wide
- Eight time scales from 0.05 s to 10 days
- High input/output isolation
- Wide supply range (24...240)V AC/DC
- 35 mm rail (EN 60715) mount
- "Blade + cross" - both flat blade and cross head screw drivers can be used to adjust the range and function selectors, the timing trimmer, and to disengage the rail mounting clip
- Multi-voltage versions with "PWM clever" technology
- Complies with EN 45545-2:2013 (protection against fire of materials), EN 61373 (resistance against random vibrations and shock, Category 1, Class B), EN 50155 (resistance to temperature and humidity, T1 class)

83.11

- Multi-voltage
- Mono-function

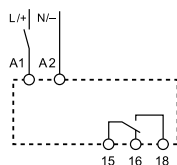
AI: On-delayWiring diagram
(without control signal)**83.21**

- Multi-voltage
- Mono-function

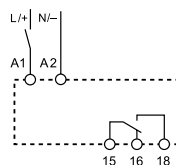
DI: IntervalWiring diagram
(without control signal)**83.41**

- Multi-voltage
- Mono-function

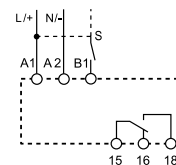
BE: Off-delay with control signalWiring diagram
(with control signal)**H**

For outline drawing see page 7

Contact specification

Contact configuration		1 CO (SPDT)	1 CO (SPDT)	1 CO (SPDT)
Rated current/Maximum peak current	A	16/30	16/30	16/30
Rated voltage/ Maximum switching voltage	V AC	250/400	250/400	250/400
Rated load AC1	VA	4000	4000	4000
Rated load AC15 (230 V AC)	VA	750	750	750
Single phase motor rating (230 V AC)	kW	0.5	0.5	0.5
Breaking capacity DC1: 30/110/220 V	A	16/0.3/0.12	16/0.3/0.12	16/0.3/0.12
Minimum switching load	mW (V/mA)	300 (5/5)	300 (5/5)	300 (5/5)
Standard contact material		AgNi	AgNi	AgNi

Supply specification

Nominal voltage (U _N)	V AC (50/60 Hz)	24...240	24...240	24...240
	V DC	24...240	24...240	24...240
Rated power AC/DC	VA (50 Hz)/W	< 1.5/< 2	< 1.5/< 2	< 1.5/< 2
Operating range	V AC	16.8...265	16.8...265	16.8...265
	V DC	16.8...265	16.8...265	16.8...265

Technical data

Specified time range		(0.05...1)s, (0.5...10)s, (0.05...1)min, (0.5...10)min, (0.05...1)h, (0.5...10)h, (0.05...1)d, (0.5...10)d		
Repeatability	%	± 1	± 1	± 1
Recovery time	ms	200	200	200
Minimum control impulse	ms	—	—	50
Setting accuracy-full range	%	± 5	± 5	± 5
Electrical life at rated load in AC1	cycles	50 · 10 ³	50 · 10 ³	50 · 10 ³
Ambient temperature range	°C	-20...+60	-20...+60	-20...+60
Protection category		IP 20	IP 20	IP 20

Approvals (according to type)

Mono-function and multi-function timer range

Type 83.62

- Power off-delay, multi-voltage, 2 Pole

Type 83.82

- Star-Delta, multi-voltage, star and delta output contacts

Type 83.91

- Asymmetrical flasher, multi-voltage, 1 Pole

- 22.5 mm wide
- Time scales:
Type 83.62 - 0.05 s to 3 minutes
Type 83.82/83.91 - 0.05 s to 10 days
- Wide supply range (24...240)V AC / DC
- 35 mm rail (EN 60715) mount
- Complies with EN 45545-2:2013 (protection against fire of materials), EN 61373 (resistance against random vibrations and shock, Category 1, Class B), EN 50155 (resistance to temperature and humidity, T1 class)

- * (0.05...2)s, (1...16)s, (8...70)s, (50...180)s
- ** (0.05...1)s, (0.5...10)s, (0.05...1)min, (0.5...10)min, (0.05...1)h, (0.5...10)h, (0.05...1)d, (0.5...10)d
- *** 0.05 s, 0.2 s, 0.3 s, 0.45 s, 0.6 s, 0.75 s, 0.85 s, 1 s

For outline drawing see page 7

Contact specification

Contact configuration		2 CO (DPDT)	2 NO (DPST-NO)	1 CO (SPDT)
Rated current/Maximum peak current	A	8/15	16/30	16/30
Rated voltage/Maximum switching voltage	V AC	250/400	250/400	250/400
Rated load AC1	VA	2000	4000	4000
Rated load AC15 (230 V AC)	VA	400	750	750
Single phase motor rating (230 V AC)	kW	0.3	0.5	0.5
Breaking capacity DC1: 30/110/220 V	A	8/0.3/0.12	16/0.3/0.12	16/0.3/0.12
Minimum switching load	mW (V/mA)	300 (5/5)	300 (5/5)	300 (5/5)
Standard contact material		AgNi	AgNi	AgNi

Supply specification

Nominal voltage (U _N)	V AC (50/60 Hz)	24...240	24...240	24...240
	V DC	24...220	24...240	24...240
Rated power AC/DC	VA (50 Hz)/W	< 1.5/< 2	< 1.5/< 2	< 1.5/< 2
Operating range	V AC	16.8...265	16.8...265	16.8...265
	V DC	16.8...242	16.8...265	16.8...265

Technical data

Specified time range		*	**	
Repeatability	%	± 1	± 1	± 1
Recovery time	ms	—	200	200
Minimum control impulse	ms	500 ms (A1 - A2)	—	50
Setting accuracy-full range	%	± 5	± 5	± 5
Electrical life at rated load in AC1	cycles	100·10 ³	50·10 ³	50·10 ³
Ambient temperature range	°C	-20...+60	-20...+60	-20...+60
Protection category		IP 20	IP 20	IP 20

Approvals (according to type)



83.62



- Multi-voltage
- Mono-function
- 2 pole

BI: Power off-delay (True off-delay)

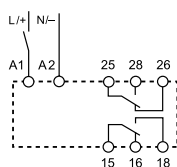

Wiring diagram (without control signal)

83.82



- Multi-voltage
- Mono-function
- 2 pole
- Transfer time can be regulated (0.05...1)s***

SD: Star-delta

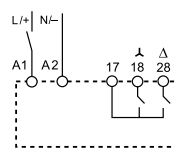

Wiring diagram (without control signal)

83.91



- Multi-voltage
- Multi-function

- LI:** Asymmetrical flasher (starting pulse on)
- LE:** Asymmetrical flasher (starting pulse on) with control signal
- PI:** Asymmetrical flasher (starting pulse off)
- PE:** Asymmetrical flasher (starting pulse off) with control signal

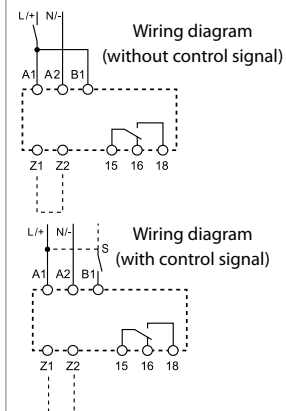

Ordering information

Example: 83 series, modular timers, 1 CO (SPDT) - 16 A, supply rated at (24...240)V AC/DC.

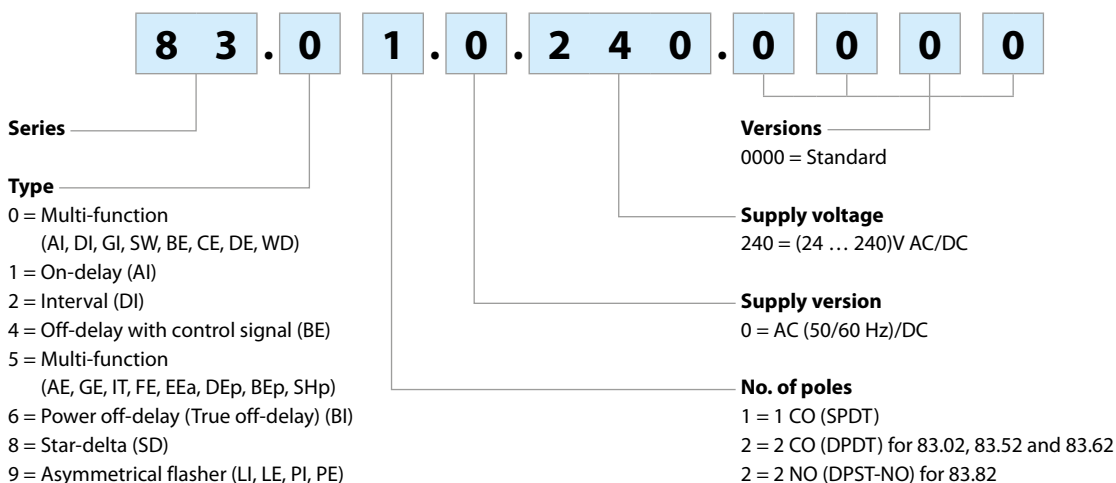

Technical data

Insulation

Dielectric strength	between input and output circuit	V AC	4000
	between open contacts	V AC	1000
Insulation (1.2/50 µs) between input and output		kV	6

EMC specifications

Type of test	Reference standard	83.01/02/52/11/21/41/82/91	83.62	
Electrostatic discharge	contact discharge	EN 61000-4-2	4 kV	
	air discharge	EN 61000-4-2	8 kV	
Radio-frequency electromagnetic field	(80 ÷ 1000 MHz)	EN 61000-4-3	10 V/m	
	(1000 ÷ 2700 MHz)	EN 61000-4-3	3 V/m	
Fast transients (burst) (5-50 ns, 5 and 100 kHz)	on Supply terminals	EN 61000-4-4	7 kV	
	on control signal terminal (B1)	EN 61000-4-4	6 kV	
Surges (1.2/50 µs) on Supply terminals	common mode	EN 61000-4-5	6 kV	
	differential mode	EN 61000-4-5	6 kV	
	on control signal terminal (B1)	common mode	EN 61000-4-5	6 kV
	differential mode	EN 61000-4-5	4 kV	
Radio-frequency common mode	(0.15 ÷ 80 MHz)	EN 61000-4-6	10 V	
	on Supply terminals	(80 ÷ 230 MHz)	EN 61000-4-6	10 V
Radiated and conducted emission		EN 55022	class A	

Other data

Current absorption on control signal (B1)	< 1 mA			
- max cable length (capacity of ≤ 10 nF/100 m)	150 m			
- when applying a control signal to B1, which is different from the supply voltage at A1/A2	B1 is isolated from A1 and A2 by an opto-coupler, and can therefore be operated at a voltage other than the supply voltage. If using a control signal of between (24... 48)V DC and a supply voltage of (24...240)V AC, ensure that the signal - is connected to A2 and the + is applied to B1, and that L is applied to B1 and N to A2.			
External potentiometer for 83.02/52	Use a 10 kΩ / ≥ 0.25 W linear potentiometer. Maximum cable length 10 m. When using an external potentiometer, the timer automatically use its setting in place of the internal setting. Consider the voltage potential at the potentiometer to be the same as the timer supply voltage.			
Power lost to the environment	without contact current	W	1.4	
	with rated current	W	3.2	
Screw torque		Nm	0.8	
	Max. wire size	solid cable	mm ²	1 x 6 / 2 x 4
		stranded cable	mm ²	1 x 4 / 2 x 2.5
	AWG		1 x 10 / 2 x 12	

Outline drawings

83.01
Screw terminal

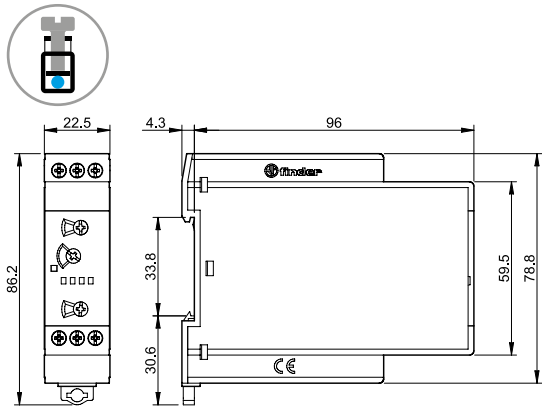

83.02/52
Screw terminal

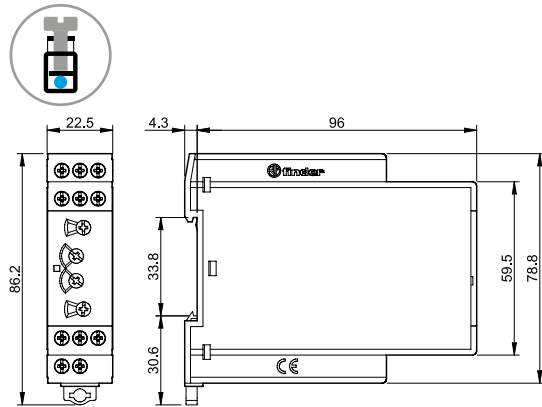

83.11
Screw terminal

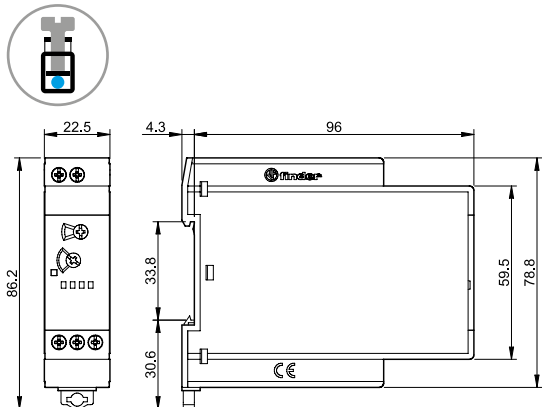

83.21
Screw terminal

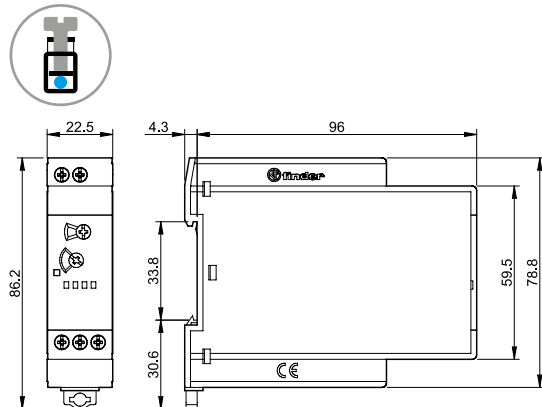

83.41
Screw terminal

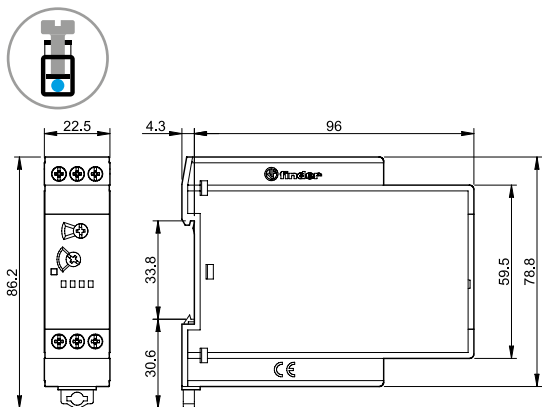

83.62
Screw terminal

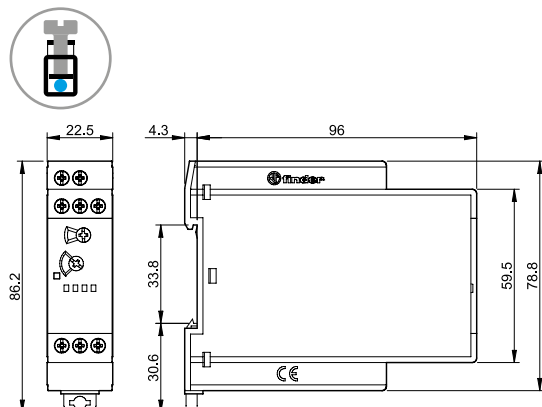

83.82
Screw terminal

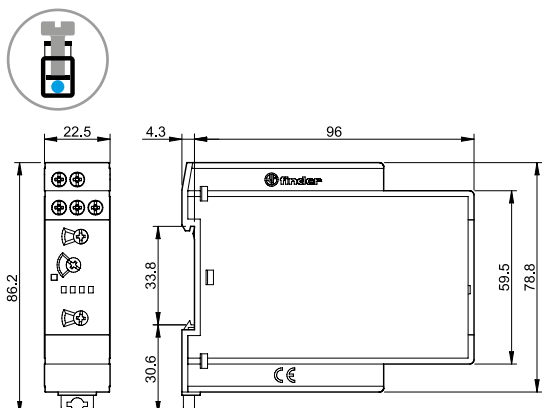

83.91
Screw terminal

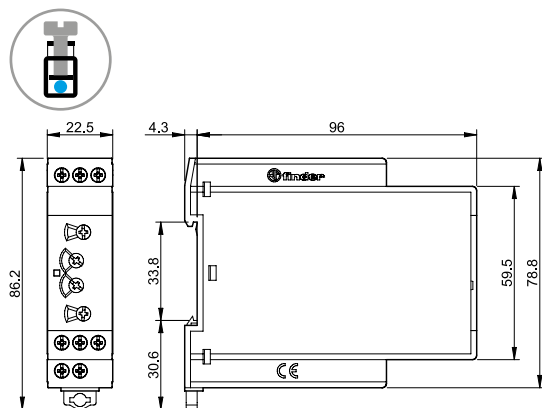

Accessories

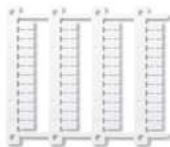

060.48

<p>Sheet of marker tags (CEMBRE Thermal transfer printers) for relays types 83.01/11/21/41/62/82, plastic, 48 tags, 6 x 12 mm</p>	060.48
--	--------



087.02.2

<p>Potentiometer usable as external potentiometer for type 83.02/52 10 kΩ / 0.25 W linear, IP 66</p>	087.02.2
---	----------

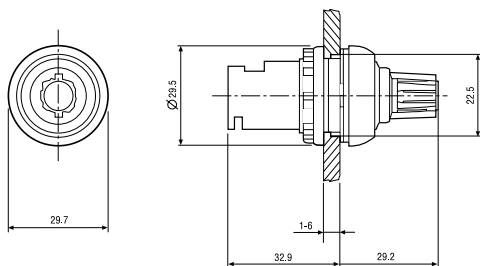
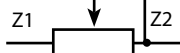

Functions

H

LED*	Supply voltage	NO output contact	Contacts	
			Open	Closed
	OFF	Open	15 - 18 25 - 28	15 - 16 25 - 26
	ON	Open	15 - 18 25 - 28	15 - 16 25 - 26
	ON	Open (Timing in Progress)	15 - 18 25 - 28	15 - 16 25 - 26
	ON	Closed	15 - 16 25 - 26	15 - 18 25 - 28

* The LED on type 83.62 is illuminated when supply voltage is supplied to timer.

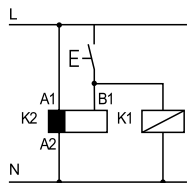

• Possible to control an external load, such as another relay coil or timer, connected to the control signal terminal B1.

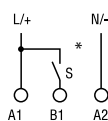

* With DC supply, positive polarity has to be connected to B1 terminal (according to EN 60204-1).

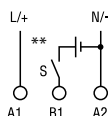

** A voltage other than the supply voltage can be applied to the control signal (B1), example:
A1 - A2 = 230 V AC
B1 - A2 = 12 V DC

Functions

Wiring diagram

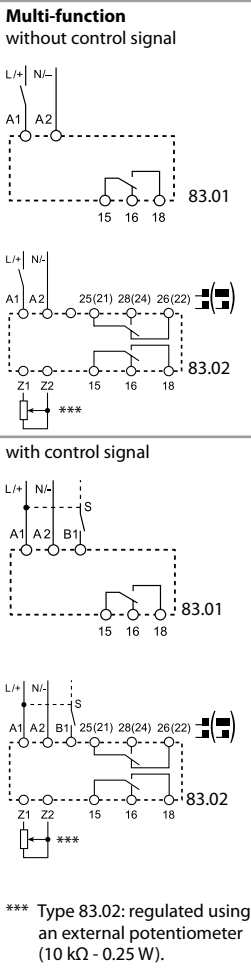

U = Supply voltage

S = Signal switch

= Output contact

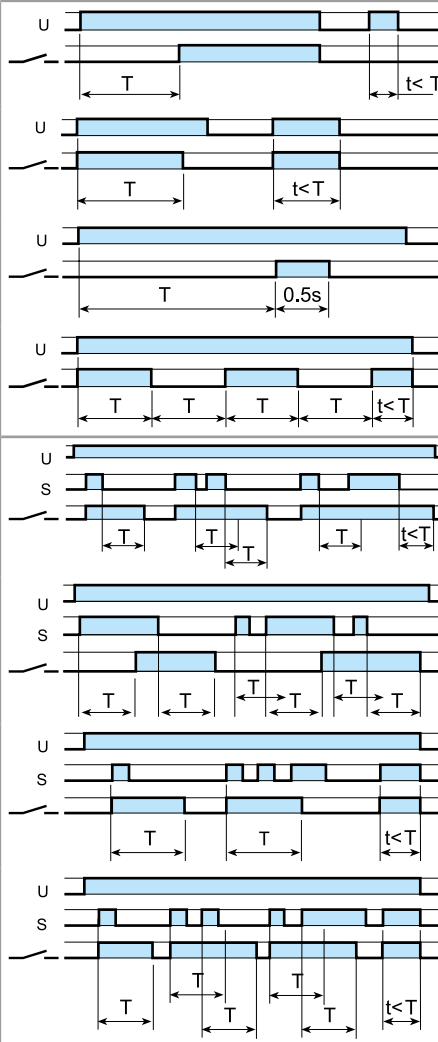

(AI) On-delay.
Apply power to timer. Output contacts transfer after preset time has elapsed. Reset occurs when power is removed.

(DI) Interval.
Apply power to timer. Output contacts transfer immediately. After the preset time has elapsed, contacts reset.

(GI) Pulse delayed.
Apply power to timer. Output contacts transfer after preset time has elapsed. Reset occurs after a fixed time of 0.5s.

(SW) Symmetrical flasher (starting pulse on).
Apply power to timer. Output contacts transfer immediately and cycle between ON and OFF for as long as power is applied. The ratio is 1:1 (time on = time off).

(BE) Off-delay with control signal.
Power is permanently applied to the timer. The output contacts transfer immediately on closure of the control signal (S). Opening the control signal initiates the preset delay, after which time the output contacts reset.

(CE) On- and off-delay with control signal.
Power is permanently applied to the timer. Closing the control signal (S) initiates the preset delay, after which time the output contacts transfer. Opening the control signal initiates the same preset delay, after which time the output contacts reset.

(DE) Interval with control signal on.
Power is permanently applied to the timer. On momentary or maintained closure of control signal (S), the output contacts transfer, and remain so for the duration of the preset delay, after which they reset.

(WD) Watchdog (Retriggerable interval with control signal on).
Power is permanently applied to the timer. On momentary or maintained closure of control signal (S), the output contacts transfer, and remain so for the duration of the preset delay, after which they reset; subsequent closures of control signal during the delay will extend the time. If the closure of the control signal (S) is longer than the preset time (T) then the output contacts reset.

NOTE: The timing function must be set when the timer is de-energised. Or for the 83.02/52, when the contact mode selector is in the OFF position.

83.02 type

Contact mode selector	Functions without control signal (example: AI)	Functions with control signal (example: BE)
2 timed contacts 	<p>Both output contacts (15-18 and 25-28) follow the timing function</p>	<p>Both output contacts (15-18 and 25-28) follow the timing function</p>
OFF 	<p>Both output contacts [15-18 and 25(21)-28(24)] stay permanently open</p>	<p>Both output contacts [15-18 and 25(21)-28(24)] stay permanently open</p>
1 timed + 1 instantaneous contact 	<p>The output contact 15-18 follows the timing function The output contact 21-24 follows the power supply (U)</p>	<p>The output contact 15-18 follows the timing function The output contact 21-24 follows the control signal (S)</p>

Functions

Wiring diagram

Multi-function with control signal

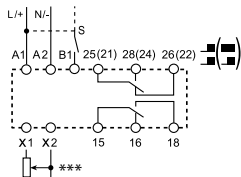

*** Regulated using an external potentiometer (10 kΩ - 0.25 W).

with control signal and pause signal

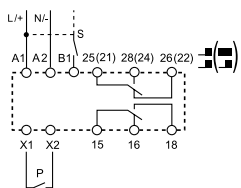

Type 83.52

U = Supply voltage S = Signal switch P = Pause switch = Output contact

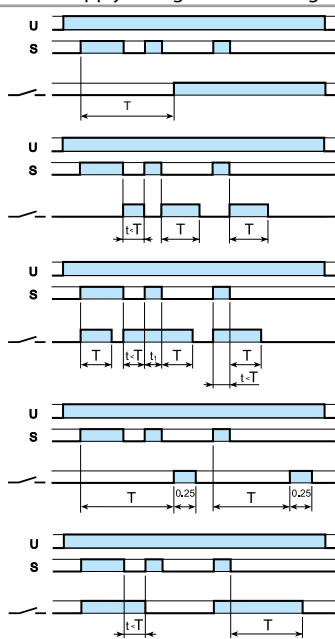

(AE) On-delay with control signal.

Power is permanently applied to the timer. Closing the Signal Switch (S) initiates the preset delay, after which times the output contacts transfer and remain so until the power is removed.

(EEa) Interval with control signal off (retriggerable).

Power is permanently applied to the timer. On opening of the Signal Switch (S) the output contacts transfer, and remain so for the duration of the preset delay, after which they reset.

(FE) Interval with control signal on and off.

Power is permanently applied to the timer. Both the opening and the closing of the Signal Switch (S) initiates the transfer of the output contacts. In both instances the contacts reset after the preset delay has elapsed.

(GE) Pulse delayed with control signal on.

Power is permanently applied to the timer. Closing the Signal Switch (S) initiates the preset delay, after which the output contacts transfer. Reset occurs after a fixed time of 0.25 s.

(IT) Timing step.

Closing the Signal Switch (S) the output contacts transfer and remain so, after S opening, for the duration of the preset delay, after which they reset. During the timing period it is possible to immediately open the contact with a further impulse on S.

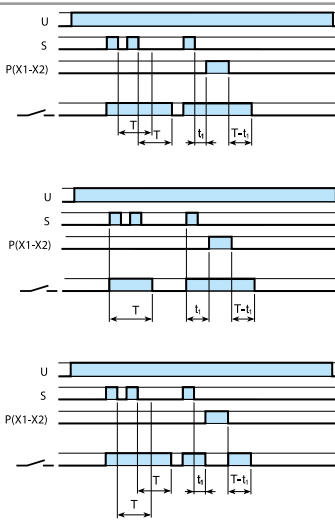

(BEp) Off-delay with control signal and pause signal.

Power is permanently applied to the timer. The output contacts transfer immediately on closure of the Signal Switch (S). Opening the signal switch initiates the preset delay, after which the output contacts reset. Closure of the pause switch (X1-X2) will immediately halt the timing process, but the elapsed time will be retained. The current state of the output contacts will be maintained. On opening of the pause switch, timing resumes from the retained value.

(DEp) Interval with control signal on and pause signal.

Power is permanently applied to the timer. On momentary or maintained closure of Signal Switch (S), the output contacts transfer, and remain so for the duration of the preset delay, after which they reset. Closure of the pause switch (X1-X2) will immediately halt the timing process, but the elapsed time will be retained. The current state of the output contacts will be maintained. On opening of the pause switch, timing resumes from the retained value.

(SHp) "Shower" function (Off-delay with control signal and pause signal).

Power is permanently applied to the timer. The output contacts transfer immediately on closure of the Signal Switch (S). Opening the signal switch initiates the preset delay, after which the output contacts reset. Closure of the pause switch (X1-X2) will immediately halt the timing process, but the elapsed time will be retained. During the pause, the output contacts 15-18 and 25-28 will be open. On opening of the pause switch, timing resumes from the retained value and the output contacts will take the previous condition.

83.52 type

Contact mode selector	Functions with control signal and pause signal (example: BEp)	Function SHp
2 timed contacts 	<p>Both output contacts (15-18 and 25-28) follow the timing function</p>	<p>Both output contacts (15-18 and 25-28) follow the timing function</p>
OFF 	<p>Both output contacts [15-18 and 25(21)-28(24)] stay permanently open</p>	<p>Both output contacts [15-18 and 25(21)-28(24)] stay permanently open</p>
1 timed + 1 instantaneous contact 	<p>The output contact 15-18 follows the timing function The output contact 21-24 follows the control signal (S)</p>	<p>The output contact 15-18 follows the timing function. The output contact 21-24 is always open, unless during the pause, when is closed</p>

Functions

Wiring diagram

U = Supply voltage

S = Signal switch

= Output contact

Function	Wiring Diagram	Type	Timing Diagram	Description
Mono-function without control signal		83.11		(AI) On-delay. Apply power to timer. Output contacts transfer after preset time has elapsed. Reset occurs when power is removed.
		83.21		(DI) Interval. Apply power to timer. Output contacts transfer immediately. After the preset time has elapsed, contacts reset.
		83.62		(BI) Power off-delay (True off-delay). Apply power to timer (minimum 500 ms). Output contacts transfer immediately. Removal of power initiates the preset delay, after which time the output contacts reset.
		83.82		(SD) Star-3delta. Apply power to timer. The star contact (λ) closes immediately. After preset delay has elapsed the star contact (λ) resets. After a further time (settable from 0.05 s to 1 s) the delta contact (Δ) closes and remains in that position, until reset on power off.
with control signal (S)		83.41		(BE) Off-delay with control signal. Power is permanently applied to the timer. The output contacts transfer immediately on closure of the control signal (S). Opening the control signal initiates the preset delay, after which time the output contacts reset.
Asymmetrical recycler without control signal		83.91		(LI) Asymmetrical flasher (starting pulse on) - (Z1-Z2 open). Apply power to timer. Output contacts transfer immediately and cycle between ON and OFF for as long as power is applied. The ON and OFF times are independently adjustable.
				(PI) Asymmetrical flasher (starting pulse off) - (Z1-Z2 linked). Apply power to timer. Output contacts transfer after time T1 has elapsed and cycle between OFF and ON for as long as power is applied. The ON and OFF times are independently adjustable.
				(LE) Asymmetrical flasher (starting pulse on) with control signal - (Z1-Z2 open). Power is permanently applied to the timer. Closing control signal (S) causes the output contacts to transfer immediately and cycle between ON and OFF, until opened.
				(PE) Asymmetrical flasher (starting pulse off) with control signal - (Z1-Z2 linked). Power is permanently applied to the timer. Closing the control signal (S) initiates delay T1 after which the output contacts transfer and continue to cycle between OFF and ON, until the control signal is opened.
with control signal		83.91		(LE) Asymmetrical flasher (starting pulse on) with control signal - (Z1-Z2 open). Power is permanently applied to the timer. Closing control signal (S) causes the output contacts to transfer immediately and cycle between ON and OFF, until opened.
		83.91		(PE) Asymmetrical flasher (starting pulse off) with control signal - (Z1-Z2 linked). Power is permanently applied to the timer. Closing the control signal (S) initiates delay T1 after which the output contacts transfer and continue to cycle between OFF and ON, until the control signal is opened.



finder[®]

SWITCH TO THE FUTURE

Miniature plug-in timers 7 - 10 A

85
SERIES



Timers and
lighting controls



Medical and
dentistry



Drying kilns



Elevators
and lifts



Panels for
electrical
distribution



Control panels



Plug-in timer

- 85.02 - 2 Pole 10 A**
- 85.03 - 3 Pole 10 A**
- 85.04 - 4 Pole 7 A**

- Multifunctions
- Seven time scales, from 0.05 s to 100 h
- 94 series sockets for 35 mm rail (EN 60715) mount with push-in and screw terminal

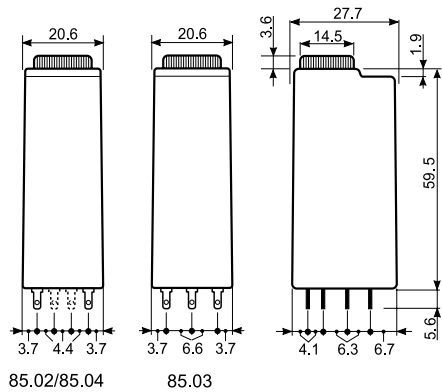

FOR UL RATINGS SEE:
"General technical information" page V

Contact specification

Contact configuration		2 CO (DPDT)	3 CO (3PDT)	4 CO (4PDT)
Rated current/Maximum peak current	A	10/20	10/20	7/15
Rated voltage/ Maximum switching voltage	V AC	250/400	250/400	250/250
Rated load AC1	VA	2500	2500	1750
Rated load AC15 (230 V AC)	VA	500	500	350
Single phase motor rating (230 V AC)	kW	0.37	0.37	0.125
Breaking capacity DC1: 30/110/220 V	A	10/0.25/0.12	10/0.25/0.12	7/0.25/0.12
Minimum switching load	mW (V/mA)	300 (5/5)	300 (5/5)	300 (5/5)
Standard contact material		AgNi	AgNi	AgNi

Supply specification

Nominal voltage (U _N)	V AC (50/60 Hz)	230...240	230...240	230...240
	V AC/DC	12 - 24 - 48 - 110...125 (non polarized)		
Rated power AC/DC	VA (50 Hz)/W	2/2	2/2	2/2
Operating range	AC	(0.85...1.1)U _N	(0.85...1.1)U _N	(0.85...1.1)U _N
	DC	(0.85...1.1)U _N	(0.85...1.1)U _N	(0.85...1.1)U _N

Technical data

Specified time range		(0.05...1)s, (0.5...10)s, (5...100)s, (0.5...10)min, (5...100)min, (0.5...10)h, (5...100)h		
Repeatability	%	± 2	± 2	± 2
Recovery time	ms	≤ 20	≤ 20	≤ 20
Minimum control impulse	ms	—	—	—
Setting accuracy-full range	%	± 5	± 5	± 5
Electrical life at rated load in AC1	cycles	200 · 10 ³	200 · 10 ³	150 · 10 ³
Ambient temperature range	°C	-20...+60	-20...+60	-20...+60
Protection category		IP 40	IP 40	IP 40

Approvals (according to type)

85.02



- 2 pole, 10 A
- AC/DC supply non polarized
- Plug-in for use with 94 series sockets

- AI:** On-delay
- DI:** Interval
- SW:** Symmetrical flasher (starting pulse on)
- GI:** Pulse delayed

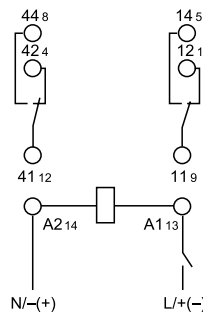

Wiring diagram
(without control signal)

85.03



- 3 pole, 10 A
- AC/DC supply non polarized
- Plug-in for use with 94 series sockets

- AI:** On-delay
- DI:** Interval
- SW:** Symmetrical flasher (starting pulse on)
- GI:** Pulse delayed

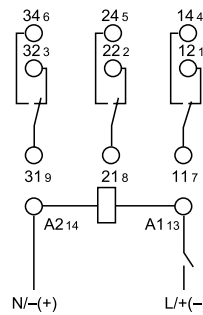

Wiring diagram
(without control signal)

85.04



- 4 pole, 7 A
- AC/DC supply non polarized
- Plug-in for use with 94 series sockets

- AI:** On-delay
- DI:** Interval
- SW:** Symmetrical flasher (starting pulse on)
- GI:** Pulse delayed

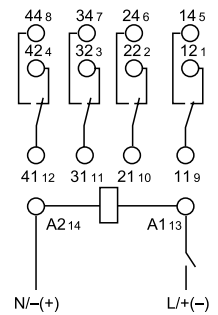

Wiring diagram
(without control signal)

Ordering information

Example: 85 series timer, 4 CO (4PDT), 24 V AC/DC supply voltage, AI, DI, GI, SW functions.



Series _____

Type _____

0 = Multifunction (AI, DI, GI, SW)*

* AI = On-delay
DI = Interval
GI = Pulse delayed
SW = Symmetrical flasher (starting pulse on)

No. of poles _____

2 = 2 pole - 10 A
3 = 3 pole - 10 A
4 = 4 pole - 7 A

Supply voltage

012 = 12 V AC/DC
024 = 24 V AC/DC
048 = 48 V AC/DC
125 = (110...125)V AC/DC
240 = (230...240)V AC

Supply version

0 = AC (50/60 Hz)/DC
8 = AC (50/60 Hz) for 240 V only

Technical data

Insulation			
Dielectric strength			85.02, 85.03
	between input and output circuit	V AC	2000
	between open contacts	V AC	1000
	between adjacent contacts	V AC	2000
			85.04
	between adjacent contacts	V AC	1550
Insulation (1.2/50 μs) between input and output		kV	6
			4
EMC specifications			
Type of test		Reference standard	
Electrostatic discharge	contact discharge	EN 61000-4-2	n.a.
	air discharge	EN 61000-4-2	8 kV
Radio-frequency electromagnetic field (80 ÷ 1000 MHz)		EN 61000-4-3	15 V/m
Fast transients (burst) (5-50 ns, 5 kHz) on Supply terminals		EN 61000-4-4	4 kV
Surges (1.2/50 μs) on Supply terminals	common mode	EN 61000-4-5	4 kV
	differential mode	EN 61000-4-5	2 kV
Radio-frequency common mode (0.15 ÷ 80 MHz) on Supply terminals		EN 61000-4-6	10 V
Power-frequency (50 Hz)		EN 61000-4-8	30 A/m
Radiated and conducted emission		EN 55022	class B
Other data			
Power lost to the environment	without contact current	W	1.6
	with rated current	W	3.7 (85.02) 4.7 (85.03) 3.6 (85.04)

Times scales

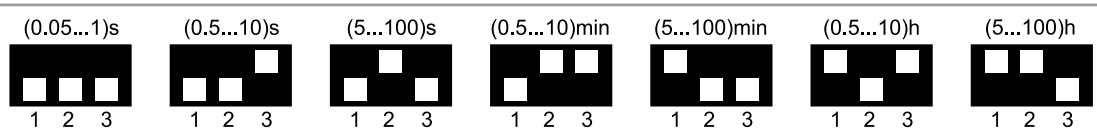

NOTE: time scales and functions must be set before energising the timer.

Functions

- U** = Supply voltage
- = Output contact

LED	Supply voltage	NO (SPDT-NO) output contact	Contacts	
			Open	Closed
	OFF	Open	x1 - x4	x1 - x2
	ON	Open	x1 - x4	x1 - x2
	ON	Open (Timing in Progress)	x1 - x4	x1 - x2
	ON	Closed	x1 - x2	x1 - x4

Wiring diagram

Type: 85.02, 85.03, 85.04

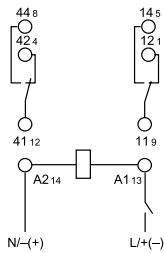

85.02

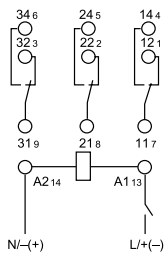

85.03

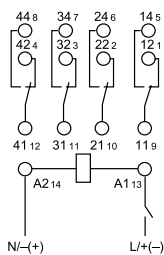

85.04

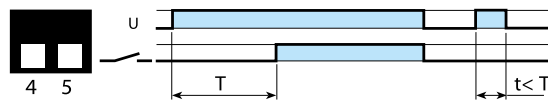

(AI) On-delay.

Apply power to timer.
Output contacts transfer after preset time has elapsed.
Reset occurs when power is removed.

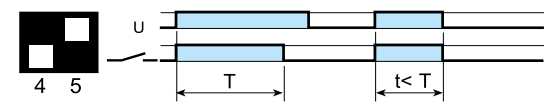

(DI) Interval.

Apply power to timer.
Output contacts transfer immediately.
After the preset time has elapsed, contacts reset.



(GI) Pulse delayed.

Apply power to timer. Output contacts transfer after preset time has elapsed. Reset occurs after a fixed time of 0.5 s.

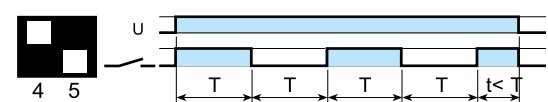

(SW) Symmetrical flasher (starting pulse on).

Apply power to timer.
Output contacts transfer immediately and cycle between ON and OFF for as long as power is applied.
The ratio is 1:1 (time on = time off).

- U** = Supply voltage
- S** = Signal switch
- U_c** = Supply voltage to the timer
- 11-14** = Self-holding contact
- = Output contact

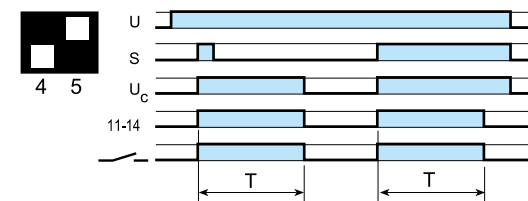

Signal ON Pulse

On momentary closure of Signal Switch (S) > 50 ms, the output contacts transfer and remain so (with self-holding on contact 11-14) for the duration of the preset delay, after which they reset.

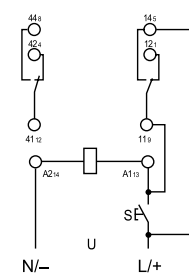

85.02

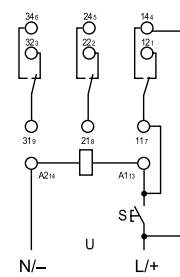

85.03

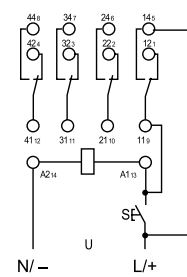

85.04

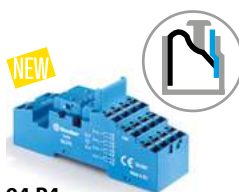

94.P4

Approvals
(according to type):

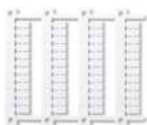

060.48

Push-in terminal socket panel or 35 mm (EN 60715) rail mount	94.P3 Blue	94.P4 Blue
For timer type	85.03	85.02, 85.04
Accessories		
Metal retaining clip		094.81
6-way jumper link		094.56
Identification tag		094.00.4
2-way jumper link		094.52.1
2-way jumper link		097.52
Marker tag holder		097.00
Sheet of marker tags for marker tag holder 097.00, 48 tags, 6 x 12 mm for CEMBRE thermal transfer printers		060.48
Technical data		
Rated values	10 A - 250 V	
Dielectric strength	2 kV AC	
Protection category	IP 20	
Ambient temperature	°C -40...+70	
Wire strip length	mm	8
Min. wire size for 94.P3 and 94.P4 sockets	solid wire	stranded wire
	mm ²	0.5
	AWG	21
Max. wire size for 94.P3 and 94.P4 sockets	solid wire	stranded wire
	mm ²	2 x 1.5 / 1 x 2.5
	AWG	2 x 18 / 1 x 14

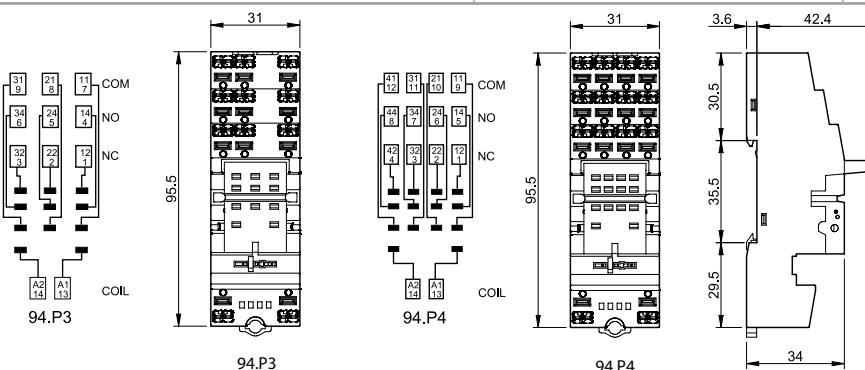

6-way jumper link for 94.P3 and 94.P4 sockets	094.56 (blue)
Rated values	10 A - 250 V

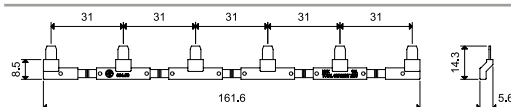

2-way jumper link for 94.P3 and 94.P4 sockets	094.52.1
Rated values	10 A - 250 V

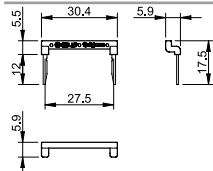

2-way jumper link for 94.P3 and 94.P4 sockets	097.52
Rated values	10 A - 250 V

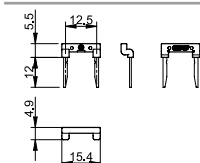

Marker tag holder for 94.P3 and 94.P4 sockets	097.00
--	--------

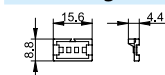

H



094.56



094.52.1



097.52



097.00



94.04

Approvals
(according to type):

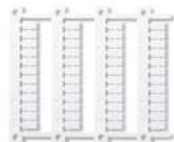

060.48

Screw terminal (Box clamp) socket panel or 35 mm (EN 60715) rail mount	94.02 Blue	94.02.0 Black	94.03 Blue	94.03.0 Black	94.04 Blue	94.04.0 Black
For timer type	85.02		85.03		85.04	
Accessories						
Metal retaining clip	094.81					
6-way jumper link	094.06	094.06.0	094.06	094.06.0	094.06	094.06.0
Identification tag	094.00.4					
Marker tag holder	097.00					
Sheet of marker tags marker tag holder 097.00, 48 tags, 6 x 12 mm for CEMBRE thermal transfer printers	060.48					
Technical data						
Rated values	10 A - 250 V					
Dielectric strength	2 kV AC					
Protection category	IP 20					
Ambient temperature	°C -40...+70					
Screw torque	Nm 0.5					
Wire strip length	mm 8					
Max. wire size for 94.02/03/04 sockets	solid wire			stranded wire		
	mm ² 1 x 6 / 2 x 2.5			1 x 4 / 2 x 2.5		
	AWG 1 x 10 / 2 x 14			1 x 12 / 2 x 14		

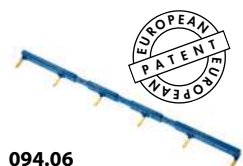
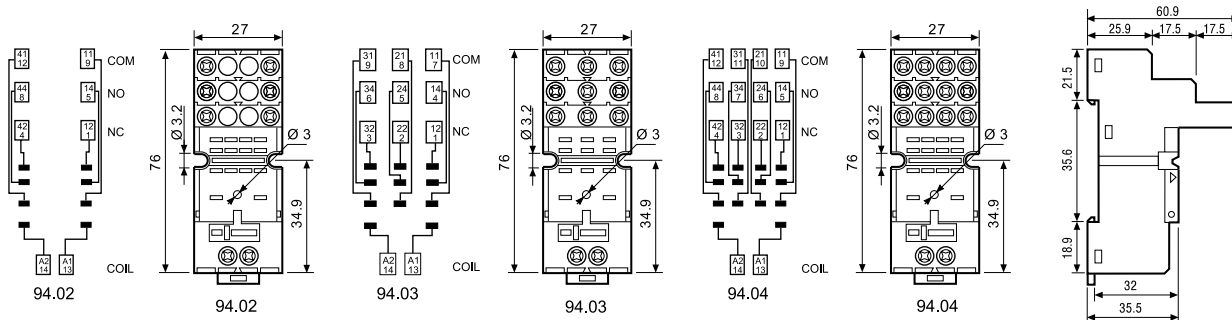

094.06

6-way jumper link for 94.02, 94.03 and 94.04 sockets	094.06 (blue)	094.06.0 (black)
Rated values	10 A - 250 V	

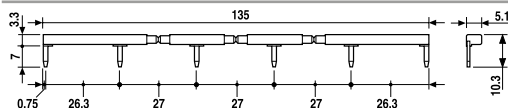

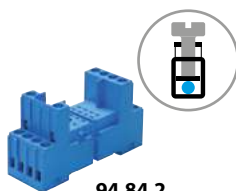

94.84.2

Approvals
(according to type):



Screw terminal (Box clamp) socket panel or 35 mm (EN 60715) rail mount	94.84.2	94.84.20
For timer type	85.02, 85.04	
Accessories		
Metal retaining clip (supplied with socket - packaging code SMA)	094.81	
6-way jumper link	094.06	094.06.0
Identification tag	094.80.3	
Technical data		
Rated values	10 A - 250 V	
Dielectric strength	2 kV AC	
Protection category	IP 20	
Ambient temperature	°C -40...+70	
Screw torque	Nm	0.5
Wire strip length	mm 7	
Max. wire size for 94.84.2 socket		solid wire
	mm ²	1 x 6 / 2 x 2.5
	AWG	1 x 10 / 2 x 14
		stranded wire
		1 x 4 / 2 x 2.5
		1 x 12 / 2 x 14

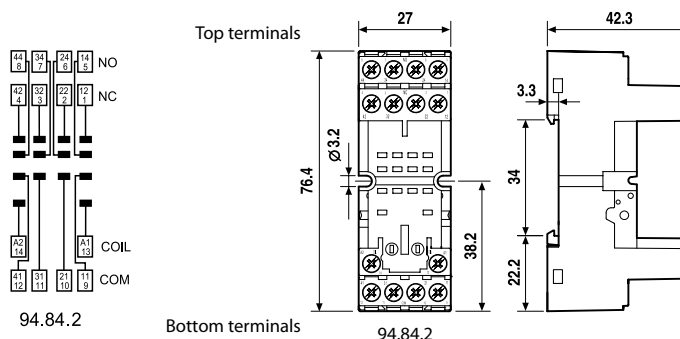

6-way jumper link for 94.84.2 socket	094.06 (blue)	094.06.0 (black)
Rated values	10 A - 250 V	



094.06

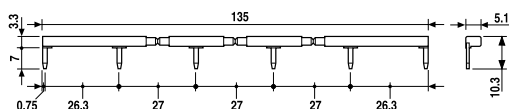



94.94.3

Approvals
(according to type):



Screw terminal (Box clamp) socket panel or 35 mm rail mount	94.92.3 (blue)	94.92.30 (black)	94.94.3 (blue)	94.94.30 (black)
For timer type	85.02		85.04	
Accessories				
Metal retaining clip	094.81			
6-way jumper link	094.06	094.06.0	094.06	094.06.0
Identification tag	094.80.3			
Technical data				
Rated values	10 A - 250 V			
Dielectric strength	2 kV AC			
Protection category	IP 20			
Ambient temperature	°C	-25...+70		
Screw torque	Nm	0.5		
Wire strip length	mm	8		
Max. wire size for 94.92.3 and 94.94.3 sockets		solid wire		stranded wire
	mm ²	1 x 6 / 2 x 2.5		1 x 4 / 2 x 2.5
	AWG	1 x 10 / 2 x 14		1 x 12 / 2 x 14

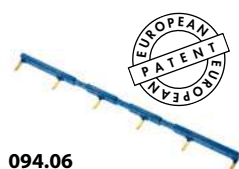
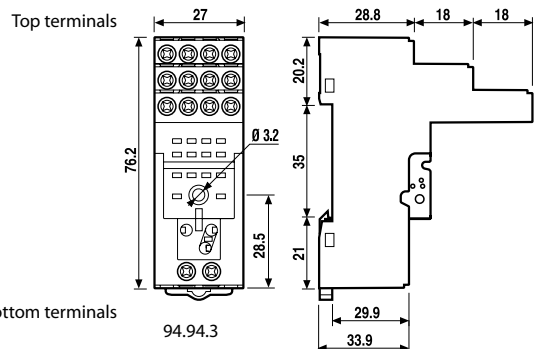
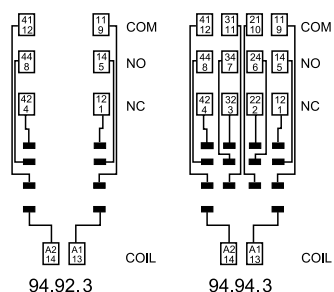

094.06



6-way jumper link for 94.92.3 and 94.94.3 sockets	094.06 (blue)	094.06.0 (black)
Rated values	10 A - 250 V	

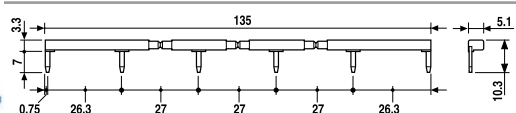

H



94.74
Approvals
(according to type):



94.82
Approvals
(according to type):



Screw terminal (Plate clamp) socket panel or 35 mm rail (EN 60715) mount	94.72 Blue	94.72.0 Black	94.73 Blue	94.73.0 Black	94.74 Blue	94.74.0 Black
For timer type	85.02		85.03		85.02, 85.04	
Accessories						
Metal retaining clip (supplied with timer)	094.81					
Screw terminal socket panel or 35 mm rail (EN 60715) mount	94.82 Blue				94.82.0 Black	
For timer type	85.02		85.02			
Accessories						
Metal retaining clip (supplied with timer)	094.81					
Technical data						
Rated values	10 A - 250 V					
Dielectric strength	2 kV AC					
Protection category	IP 20					
Ambient temperature	°C -40...+70					
Screw torque	Nm 0.5					
Wire strip length	mm 8 (94.72, 94.73, 94.74)				9 (94.82)	
Max. wire size for 94.72, 94.73, 94.74 and 94.82 sockets	solid wire				stranded wire	
	mm ² 1 x 2.5 / 2 x 1.5				1 x 2.5 / 2 x 1.5	
	AWG 1 x 14 / 2 x 16				1 x 14 / 2 x 16	

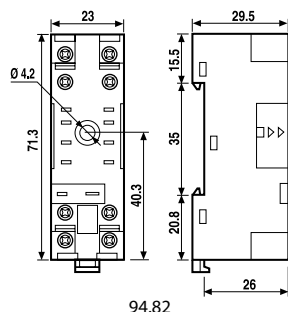
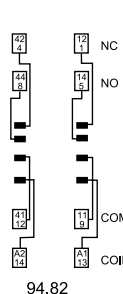
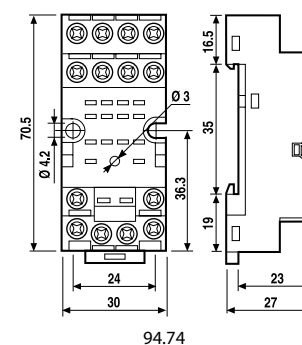
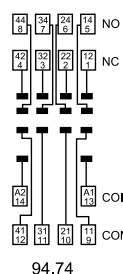
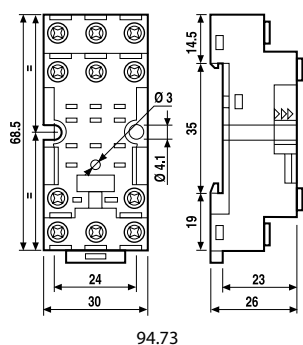
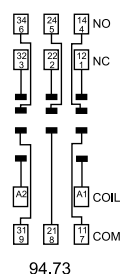
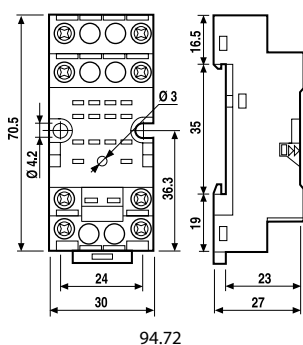
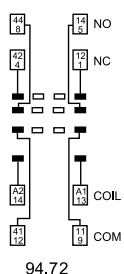



finder[®]
SWITCH TO THE FUTURE

Timer modules

86
SERIES



Machines for ceramics



Machines for paper processing



Printing machines



Packaging machines



Wood-processing machines



Milk processing plant



Textile machines

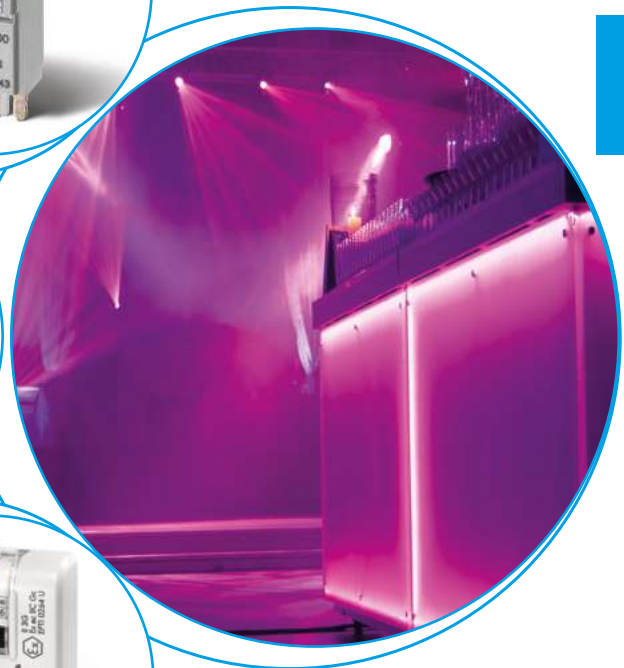
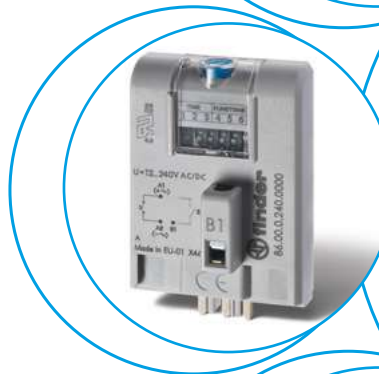

Timer modules for use in conjunction with relay & socket.

86.00 - Multi-function & multi-voltage timer module

86.30 - Bi-function & multi-voltage timer module

- Timer module type 86.00 for 90, 92, 96 series sockets and type 86.30 for 90, 92, 94, 95, 96, 97 series sockets
- Wide supply voltage range:
12...240 V AC/DC (86.00)
12...24 V AC/DC or 230...240 V AC (86.30)
- LED indicator
- Atex versions available

86.00



- Time scale: from 0.05 s to 100 h
- Multi-function
- Plug-in for use with 90.02, 90.03, 92.03 and 96.04 sockets

86.30



- Time scale: from 0.05 s to 100 h
- Bi-function
- Plug-in for use with 90.02, 90.03, 92.03, 94.P3, 94.P4, 94.02, 94.03, 94.04, 95.P3, 95.P5, 95.03, 95.05, 96.02, 96.04, 97.P1, 97.P2, 97.01 and 97.02 sockets

- AI:** On-delay
DI: Interval
SW: Symmetrical flasher (starting pulse on)
BE: Off-delay with control signal
CE: On- and off-delay with control signal
DE: Interval with control signal on
EE: Interval with control signal off
FE: Interval with control signal on and off

- AI:** On-delay
DI: Interval

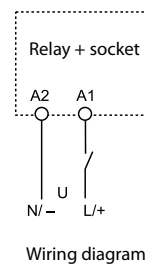
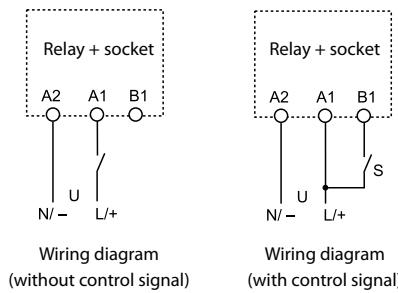

* For Atex versions, refer to the "Other data" table on the page 2
 For outline drawing see page 3

Contact specification*

Contact configuration	
Rated current/Maximum peak current	A
Rated voltage/Maximum switching voltage	V AC
Rated load AC1	VA
Rated load AC15 (230 V AC)	VA
Single phase motor rating (230 V AC)	kW
Breaking capacity DC1: 30/110/220 V	A
Minimum switching load	mW (V/mA)
Standard contact material	

See 56, 60 and 62 series relays
 Note: Do not use with relays 62.3x.x012.x300 and 62.3x.x012.x600

See 40, 44, 46, 55, 56, 60 and 62 series relays

Supply specification*

Nominal voltage (U _N)	V AC (50/60 Hz)	12...240	12...24	110...125	230...240
	V DC				
Rated power AC/DC	W	1.2	0.15		
Operating range	V AC (50/60 Hz)	10.2...265	9.6...33.6	88...137	184...265
	DC	10.2...265	9.6...33.6	—	—

Technical data

Specified time range		(0.05...1)s, (0.5...10)s, (5...100)s, (0.5...10)min, (5...100)min, (0.5...10)h, (5...100)h			
Repeatability	%	± 1	± 1		
Recovery time	ms	≤ 50	≤ 50		
Minimum control impulse	ms	50	—		
Setting accuracy full range	%	± 5	± 5		
Electrical life at rated load in AC1	cycles	See 56, 60 and 62 series relays	See 40, 44, 46, 55, 56, 60 and 62 series relays		
Ambient temperature range	°C	-20...+50	-20...+50		
Protection category		IP 20	IP 20		

Approvals (according to type)



Ordering information

Example: 86 series multi-function timer module, (12...240)V AC/DC supply voltage.

8 6 . 0 0 . 0 . 2 4 0 . 0 0 0 0

Series

Type

0 = Multi-function (AI, DI, SW, BE, CE, DE, EE, FE)

3 = Bi-function (AI, DI)

No. of poles

See 40, 44, 46, 55, 56, 60 and 62 series relays

Poles for chosen relay/socket combination - according to chart below

Supply voltage

024 = (12...24)V AC/DC (86.30 only)

120 = (110...125)V AC (86.30 only)

240 = (12...240)V AC/DC (86.00 only)

240 = (12...48)V AC/DC

(86.00.0.240.0073 only)

240 = (230...240)V AC (86.30 only)

Supply version

0 = AC (50/60 Hz)/DC

8 = AC (50/60 Hz)

Combinations

Number of poles	Relay type	Socket type	Timer module
1	40.31	95.P3/95.03	86.30
1	40.61	95.P5/95.05	86.30
1	46.61	97.P1/97.01	86.30
2	40.52/44.52/44.62	95.P5/95.05	86.30
2	46.52	97.P2/97.02	86.30
2	55.32	94.P4/94.02	86.30
2	56.32	96.02	86.30
2	60.12	90.02	86.00/86.30
2	62.32	92.03	86.00/86.30
3	55.33	94.P3/94.03	86.30
3	60.13	90.03	86.00/86.30
3	62.33	92.03	86.00/86.30
4	55.34	94.P4/94.04	86.30
4	56.34	96.04	86.00/86.30

H

Other data Timer ATEX versions

Code available	Nominal tension	Operating range	Use temperature
86.00.0.240.0073	12-48 V AC/DC	10.2...60 V AC/DC	-20...+50°C
86.30.0.024.0073	12-24 V AC/DC	9.6...33.6 V AC/DC	-20...+50°C

Markings - ATEX versions - ATEX, II 3G Ex ec IIC Gc

MARKING	
	Specific marking of explosion protection
II	Component for surface plant (different from mines)
3	Category 3: normal level of protection
GAS	G Explosive atmosphere due to presence of combustible gas vapour or mist
	Ex ec Increased security
	IIC Gas group
	Gc Equipment Protection Level
-20 °C ≤ Ta ≤ +50 °C Ambient temperature	
EPTI 17 ATEX 0264 U EPTI: laboratory which issues the CE type certificate 17: year of issue of certificate 0264: number of CE type certificate	
U: ATEX component	

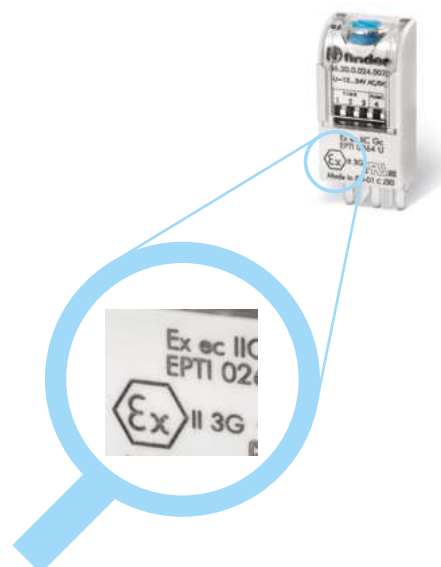

Technical data

EMC specifications				
Type of test		Reference standard	86.00	86.30
Electrostatic discharge	contact discharge	EN 61000-4-2	4 kV	n.a.
	air discharge	EN 61000-4-2	8 kV	8 kV
Radio-frequency electromagnetic field (80 ÷ 1000 MHz)		EN 61000-4-3	10 V/m	10 V/m
Fast transients (burst) (5-50 ns, 5 kHz) on Supply terminals		EN 61000-4-4	4 kV	2 kV
Surges (1.2/50 µs) on Supply terminals	common mode	EN 61000-4-5	4 kV	2 kV
	differential mode	EN 61000-4-5	4 kV	1 kV
Radio-frequency common mode (0.15 ÷ 80 MHz) on Supply terminals		EN 61000-4-6	10 V	10 V
Radiated and conducted emission		EN55022	class B	class B
Other data		86.00	86.30	
Current absorption on signal control (B1)		mA	1	—
Power lost to the environment	without contact current	W	0.1 (12 V) - 1 (230 V)	0.2
	with rated current		See 56, 60 and 62 series relays	See 40, 44, 46, 55, 56, 60, 62 series relays

Times scales

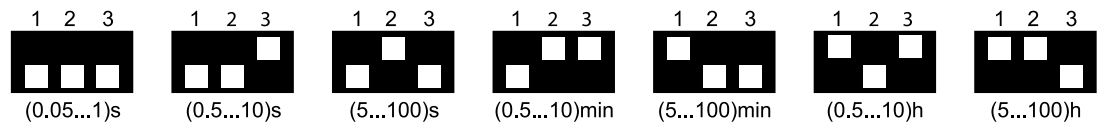

NOTE: Time scales and functions must be set before energising the timer.

To achieve the minimum time setting of 0.05 seconds it is necessary to use one of the functions with control signal. When setting very short times it may be necessary to take into account the operate time of the relay used.

Outline drawings

Type 86.00

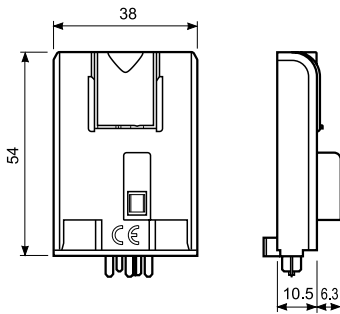

Type 86.30

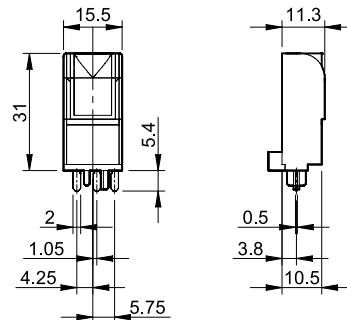

Functions

U = Supply voltage

S = Signal switch

— = Output contact

LED Type 86.00	LED Type 86.30	Supply voltage	NO output contact
		OFF	Open
		ON	Open
		ON	Open (Timing in Progress)
		ON	Closed

Without control signal = Start via contact in supply line (A1).
With control signal = Start via contact into control terminal (B1).

Wiring diagram

Without control signal

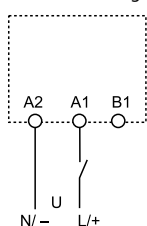

Type 86.00

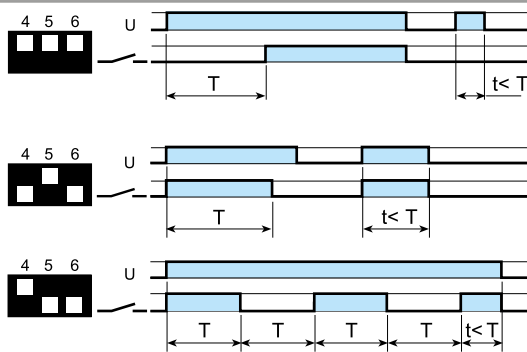

(AI) On-delay.

Apply power to timer. Output contacts transfer after preset time has elapsed. Reset occurs when power is removed.

(DI) Interval.

Apply power to timer. Output contacts transfer immediately. After the preset time has elapsed, contacts reset.

(SW) Symmetrical flasher (starting pulse on).

Apply power to timer. Output contacts transfer immediately and cycle between ON and OFF for as long as power is applied. The ratio is 1:1 (time on = time off).

With control signal

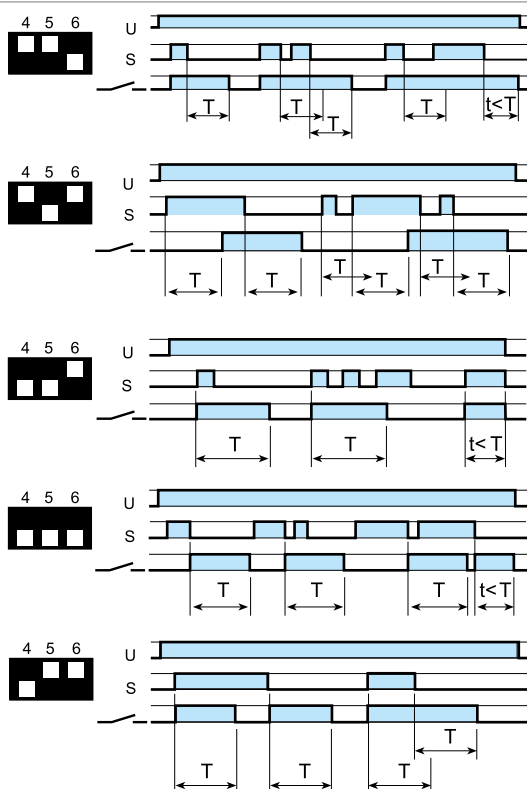
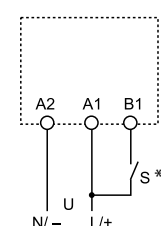

(BE) Off-delay with control signal.

Power is permanently applied to the timer. The output contacts transfer immediately on closure of the Signal Switch (S). Opening the Signal Switch initiates the preset delay, after which time the output contacts reset.

(CE) On- and off-delay with control signal.

Power is permanently applied to the timer. Closing the Signal Switch (S) initiates the preset delay, after which time the output contacts transfer. Opening the Signal switch initiates the same preset delay, after which time the output contacts reset.

(DE) Interval with control signal on.

Power is permanently applied to the timer. On momentary or maintained closure of Signal Switch (S), the output contacts transfer, and remain so for the duration of the preset delay, after which they reset.

(EE) Interval with control signal off.

Power is permanently applied to the timer. On opening of the Signal Switch (S) the output contacts transfer, and remain so for the duration of the preset delay, after which they reset.

(FE) Interval with control signal on and off.

Power is permanently applied to the timer. Both the opening and closing of the Signal Switch (S) initiates the transfer of the output contacts. In both instances the contacts reset after the delay period has elapsed.

* With DC supply, positive polarity has to be connected to B1 terminal (according to EN 60204-1). Switch S should be exclusively used to provide the control signal to terminal B1. (Do not connect any other load at this point).

Wiring diagram

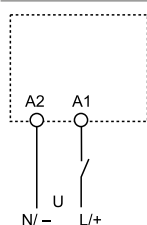

Type 86.30

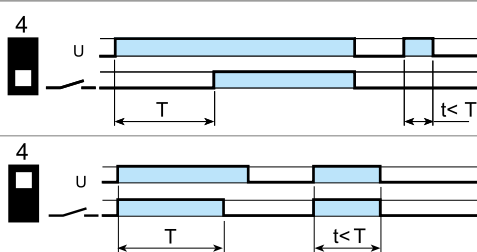

(AI) On-delay.

Apply power to timer. Output contacts transfer after preset time has elapsed. Reset occurs when power is removed.

(DI) Interval.

Apply power to timer. Output contacts transfer immediately. After the preset time has elapsed, contacts reset.



90.03
Approvals
(according to type):



Screw terminal (Box clamp) socket panel or 35 mm rail (EN 60715) mount	90.02 Blue	90.02.0 Black	90.03 Blue	90.03.0 Black
For relay type	60.12		60.13	
Accessories				
Metal retaining clip	090.33			
6-way jumper link	090.06			
Identification tag	090.00.2			
Timer module	86.00, 86.30			
Technical data				
Double terminal A1 (for easy start connection)				
Rated values	10 A - 250 V			
Dielectric strength	2 kV AC			
Protection category	IP 20			
Ambient temperature	°C -40...+70			
Screw torque	Nm 0.6			
Wire strip length	mm 10			
Max. wire size for 90.02 and 90.03 sockets	solid wire		stranded wire	
	mm ²	1 x 6 / 2 x 2.5	1 x 4 / 2 x 2.5	
	AWG	1 x 10 / 2 x 14	1 x 12 / 2 x 14	

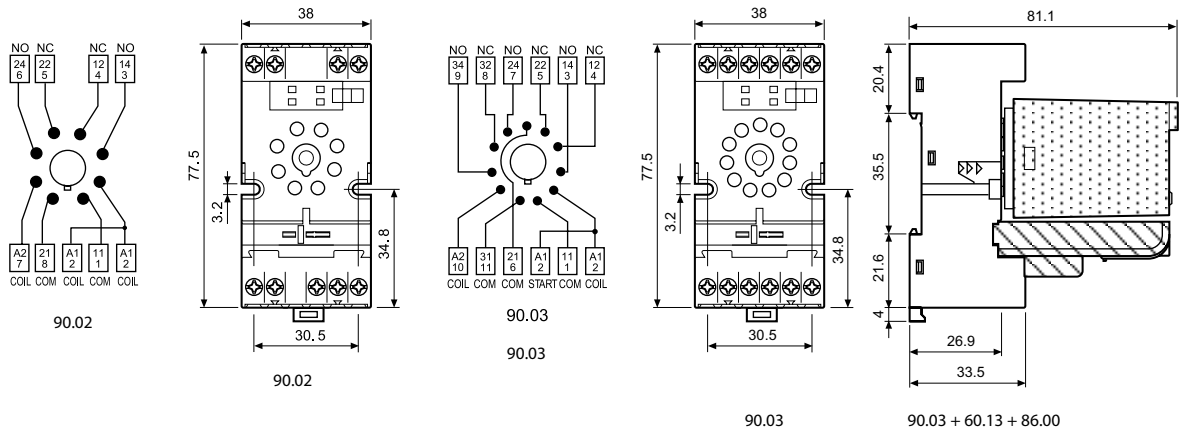

H

6-way jumper link for 90.02 and 90.03 sockets	090.06
Rated values	10 A - 250 V

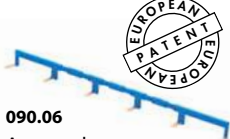

090.06
Approvals
(according to type):

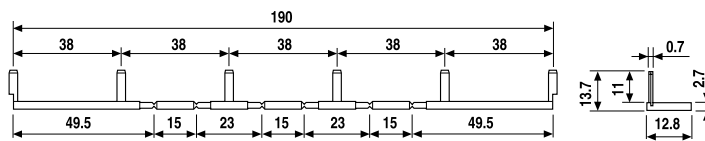



92.03
Approvals
(according to type):



Screw terminal (Box clamp) socket panel or 35 mm rail (EN 60715) mount For relay type	92.03 Blue	92.03.0 Black
	62.32, 62.33	
Accessories		
Metal retaining clip (supplied with socket - packaging code SMA)	092.71	
Identification tag	092.00.2	
Timer modules	86.00, 86.30	
Technical data		
Rated values	16 A - 250 V	
Dielectric strength	6 kV (1.2/50 μs) between coil and contacts	
Protection category	IP 20	
Ambient temperature	°C -40...+70 (see diagram L92)	
Screw torque	Nm	0.8
Wire strip length	mm 10	
Max. wire size for 92.03 socket	solid wire	stranded wire
	mm ²	1 x 10 / 2 x 4
	AWG	1 x 8 / 2 x 12

L 92 - Rated current v ambient temperature

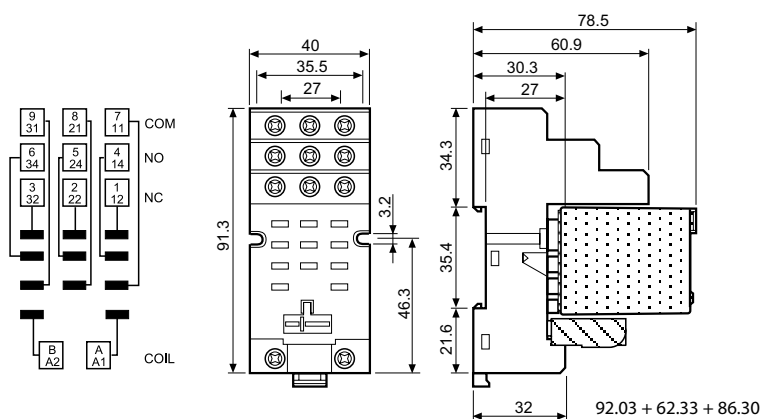
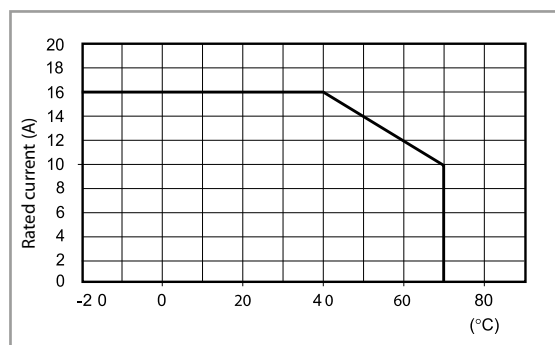

NEW

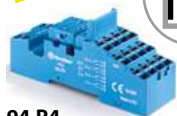

94.P4

Approvals
(according to type):



UL US Certain relay/socket combinations



094.91.3

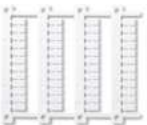

060.48

Push-in terminal socket panel or 35 mm (EN 60715) rail mount	94.P3	94.P4
For relay type	Blue	Blue
	55.33	55.32, 55.34
Accessories		
Metal retaining clip		094.71
Plastic retaining and release clip (supplied with socket - packaging code SPA)		094.91.3
6-way jumper link		094.56
Identification tag		094.00.4
2-way jumper link		094.52.1
2-way jumper link		097.52
Marker tag holder		097.00
Timer modules (see table below)		86.30
Sheet of marker tags for plastic retaining and release clip 094.91.3 and for marker tag holder 097.00, 48 tags, 6 x 12 mm for CEMBRE thermal transfer printers		060.48
Technical data		
Rated values	10 A - 250 V	
Dielectric strength	2 kV AC	
Protection category	IP 20	
Ambient temperature	°C -40...+70	
Wire strip length	mm 8	
Min. wire size for 94.P3 and 94.P4 sockets	solid wire	stranded wire
	mm ² 0.5	0.5
Max. wire size for 94.P3 and 94.P4 sockets	AWG 21	21
	solid wire	stranded wire
mm ²	2 x 1.5 / 1 x 2.5	2 x 1.5 / 1 x 2.5
AWG	2 x 18 / 1 x 14	2 x 18 / 1 x 14

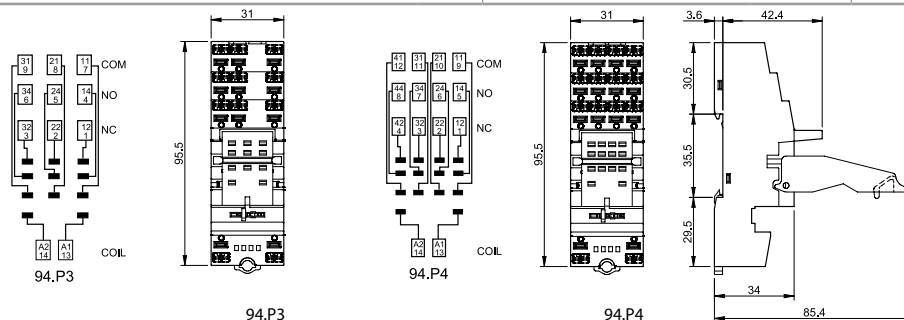

094.56



6-way jumper link for 94.P3 and 94.P4 sockets	094.56 (blue)
Rated values	10 A - 250 V

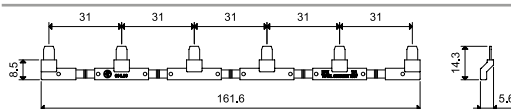

094.52.1

2-way jumper link for 94.P3 and 94.P4 sockets	094.52.1
Rated values	10 A - 250 V

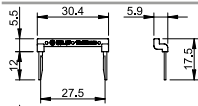

097.52

2-way jumper link for 94.P3 and 94.P4 sockets	097.52
Rated values	10 A - 250 V

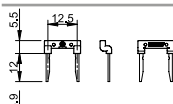

097.00

Marker tag holder for 94.P3 and 94.P4 sockets	097.00
--	--------

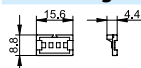

86.30

86 series timer modules	
(12...24)V AC/DC; Bi-function: AI, DI; (0.05 s...100 h)	86.30.0.024.0000
(110...125)V AC; Bi-function: AI, DI; (0.05 s...100 h)	86.30.8.120.0000
(230...240)V AC; Bi-function: AI, DI; (0.05 s...100 h)	86.30.8.240.0000

Approvals (according to type):



94.04

Approvals
(according to type):



UL US Certain relay/socket combinations



94.91.3

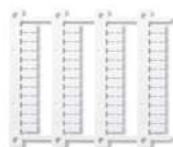

060.48

Screw terminal (Box clamp) socket panel or 35 mm (EN 60715) rail mount	94.02 Blue	94.02.0 Black	94.03 Blue	94.03.0 Black	94.04 Blue	94.04.0 Black
For relay type	55.32		55.33		55.32, 55.34	
Accessories						
Metal retaining clip	094.71					
Plastic retaining and release clip (supplied with socket - packaging code SPA)	094.91.3	094.91.30	094.91.3	094.91.30	094.91.3	094.91.30
6-way jumper link	094.06	094.06.0	094.06	094.06.0	094.06	094.06.0
Identification tag	094.00.4					
Marker tag holder	097.00					
Timer modules (see table below)	86.30					
Sheet of marker tags for plastic retaining and release clip 094.91.3 and for marker tag holder 097.00, 48 tags, 6 x 12 mm for CEMBRE thermal transfer printers	060.48					
Technical data						
Rated values	10 A - 250 V					
Dielectric strength	2 kV AC					
Protection category	IP 20					
Ambient temperature	°C -40...+70					
Screw torque	Nm 0.5					
Wire strip length	mm 8					
Max. wire size for 94.02/03/04 sockets	solid wire			stranded wire		
	mm ² 1 x 6 / 2 x 2.5			1 x 4 / 2 x 2.5		
	AWG 1 x 10 / 2 x 14			1 x 12 / 2 x 14		

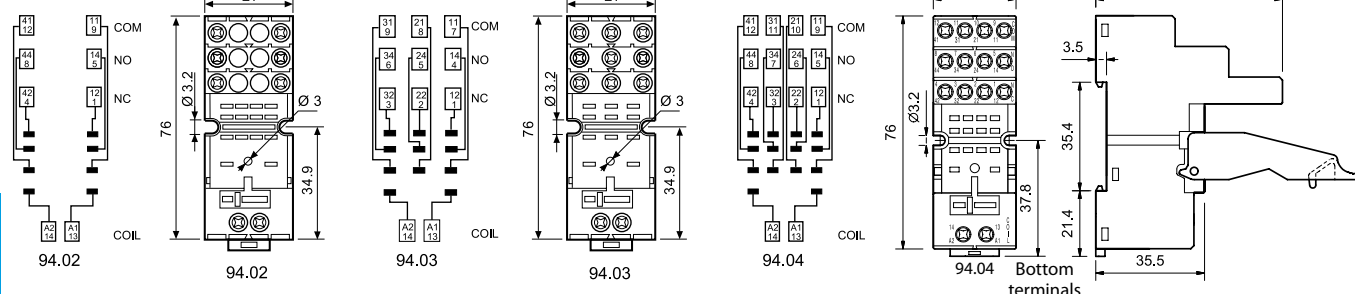

6-way jumper link for 94.02, 94.03 and 94.04 sockets	094.06 (blue)	094.06.0 (black)
Rated values	10 A - 250 V	



94.06

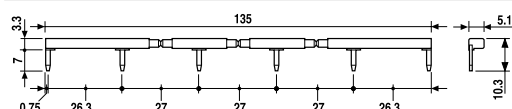

86.30

86 series timer modules	
(12...24)V AC/DC; Bi-function: AI, DI; (0.05 s...100 h)	86.30.0.024.0000
(110...125)V AC; Bi-function: AI, DI; (0.05 s...100 h)	86.30.8.120.0000
(230...240)V AC; Bi-function: AI, DI; (0.05 s...100 h)	86.30.8.240.0000

Approvals (according to type):

NEW



95.P5

Approvals
(according to type):



095.91.3

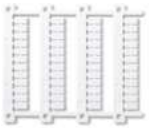

060.48

Push-in terminals socket panel or 35 mm rail mount		95.P3	95.P5
For relay type		40.31	40.51/ 52/ 61, 44.52/62
Accessories			
Metal retaining clip			095.71
Plastic retaining and release clip (supplied with socket - packaging code SPA)			095.91.3
8-way jumper link			097.58
2-way jumper link (12.5 mm pitch)			097.52
2-way jumper link (4.6 mm pitch)			097.42
Marker tag holder (for tags 060.48 type)			097.00
Timer modules (see table below)			86.30
Identification tag			095.00.4
Sheet of marker tags for plastic retaining and release clip 095.91.3 and for marker tag holder 097.00, 48 tags, 6 x 12 mm, for CEMBRE thermal transfert printer			060.48
Technical data			
Rated values		10 A - 250 V*	
Dielectric strength		6 kV (1.2/50 μs) between coil and contacts	
Protection category		IP 20	
Ambient temperature		°C -40...+70 (see diagram L95)	
Wire strip length		mm 8	
Min. wire size for 95.P3 and 95.P5 sockets		solid wire	stranded wire
		mm ² 0.5	0.5
		AWG 21	21
Max. wire size for 95.P3 and 95.P5 sockets		solid wire	stranded wire
		mm ² 2 x 1.5 / 1 x 2.5	2 x 1.5 / 1 x 2.5
		AWG 2 x 18 / 1 x 14	2 x 18 / 1 x 14

* For currents > 10 A, contact terminals must be connected in parallel (21 with 11, 24 with 14, 22 with 12).
With the relay 40.51 the change-over contact will be 21-12-14.

L 95 - Total socket current v ambient temperature

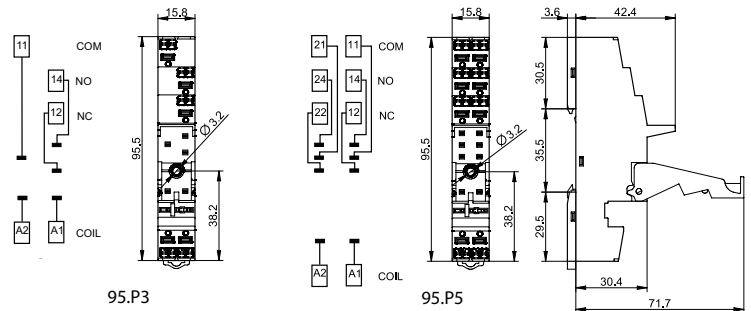
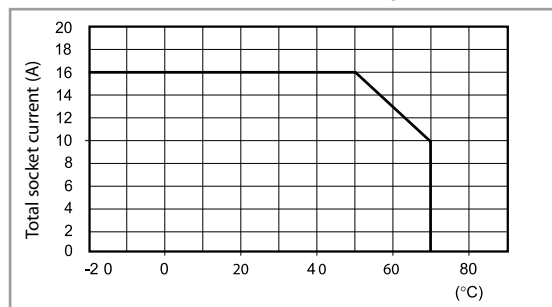

097.58

8-way jumper link for 95.P3 and 95.P5 sockets	097.58
Rated values	10 A - 250 V

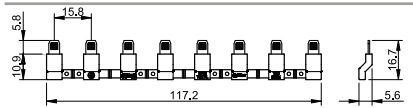

097.52

2-way jumper link for 95.P3 and 95.P5 sockets	097.52
Rated values	10 A - 250 V

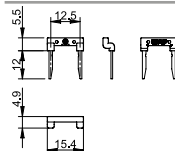

097.42

2-way jumper link for 95.P3 and 95.P5 sockets	097.42
Rated values	10 A - 250 V

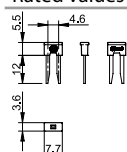

097.00

Marker tag holder for 95.P3 and 95.P5 sockets	097.00
--	--------

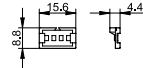

86 series timer modules	
(12...24)V AC/DC; Bi-function: AI, DI; (0.05 s...100 h)	86.30.0.024.0000
(110...125)V AC; Bi-function: AI, DI; (0.05 s...100 h)	86.30.8.120.0000
(230...240)V AC; Bi-function: AI, DI; (0.05 s...100 h)	86.30.8.240.0000

Approvals (according to type):



86.30

H



95.05
Approvals
(according to type):



UL US Certain relay/socket combinations



095.01

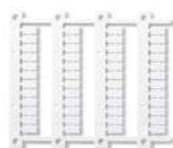

060.48

Screw terminal (Box clamp) socket panel or 35 mm rail mount	95.03 (blue)	95.03.0 (black)	95.05 (blue)	95.05.0 (black)
For relay type	40.31		40.51, 40.52, 40.61	
Accessories				
Metal retaining clip			095.71	
Plastic retaining and release clip (supplied with socket - packaging code SPA)	095.01	095.01.0	095.01	095.01.0
8-way jumper link	095.18	095.18.0	095.18	095.18.0
Marker tag holder (for tags 060.48 type)			097.00	
Identification tag			095.00.4	
Timer modules (see table below)			86.30	
Sheet of marker tags for plastic retaining and release clip 095.01 and for marker tag holder 097.00, 48 tags, 6 x 12 mm, for CEMBRE thermal transfer printers			060.48	
Technical data				
Rated values	10 A - 250 V*			
Dielectric strength	6 kV (1.2/50 μs) between coil and contacts			
Protection category	IP 20			
Ambient temperature	°C -40...+70 (see diagram L95)			
Screw torque	Nm	0.5		
Wire strip length	mm	8		
Max. wire size for 95.03 and 95.05 sockets		solid wire	stranded wire	
	mm ²	1 x 6 / 2 x 2.5		1 x 4 / 2 x 2.5
	AWG	1 x 10 / 2 x 14		1 x 12 / 2 x 14

* For currents > 10 A, contact terminals must be connected in parallel (21 with 11, 24 with 14, 22 with 12).

L 95 - Total socket current v ambient temperature

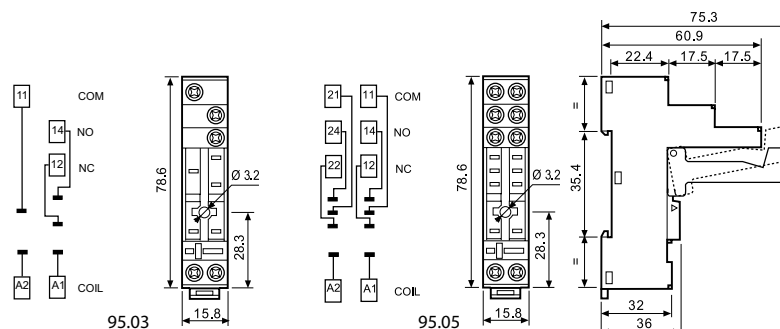
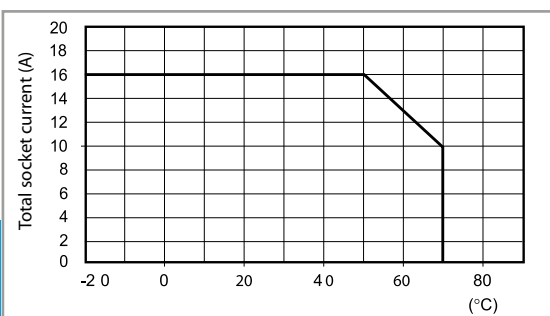

8-way jumper link for 95.03 and 95.05 sockets	095.18 (blue)	095.18.0 (black)
Rated values	10 A - 250 V	

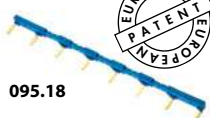

095.18

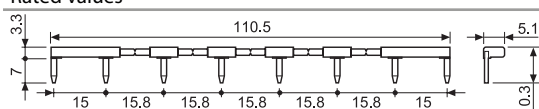

86 series timer modules	
(12...24)V AC/DC; Bi-function: AI, DI; (0.05 s...100 h)	86.30.0.024.0000
(110...125)V AC; Bi-function: AI, DI; (0.05 s...100 h)	86.30.8.120.0000
(230...240)V AC; Bi-function: AI, DI; (0.05 s...100 h)	86.30.8.240.0000

86.30

Approvals (according to type):



96.02
Approvals
(according to type):



96.04
Approvals
(according to type):



094.91.3

Screw terminal (Box clamp) socket	96.02	96.02.0	96.04	96.04.0
panel or 35 mm rail (EN 60715) mount	Blue	Black	Blue	Black
For relay type	56.32		56.34	
Accessories				
Metal retaining clip (supplied with socket - packaging code SMA)	094.71		096.71	
Plastic retaining and release clip (supplied with socket - packaging code SPA)	094.91.3	094.91.30	—	—
6-way jumper link	094.06	094.06.0	—	—
Identification tag	095.00.4		090.00.2	
Timer modules	86.30		86.00, 86.30	
Technical data				
Rated values	12 A - 250 V			
Dielectric strength	2 kV AC			
Protection category	IP 20			
Ambient temperature	°C -40...+70			
Screw torque	Nm	0.8		
Wire strip length	mm	8		
Max. wire size for 96.02/04 sockets		solid wire	stranded wire	
	mm ²	1 x 6 / 2 x 2.5	1 x 4 / 2 x 2.5	
	AWG	1 x 10 / 2 x 14	1 x 12 / 2 x 14	

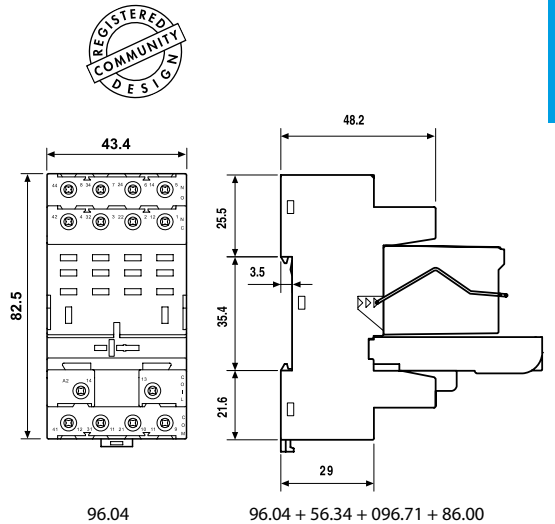
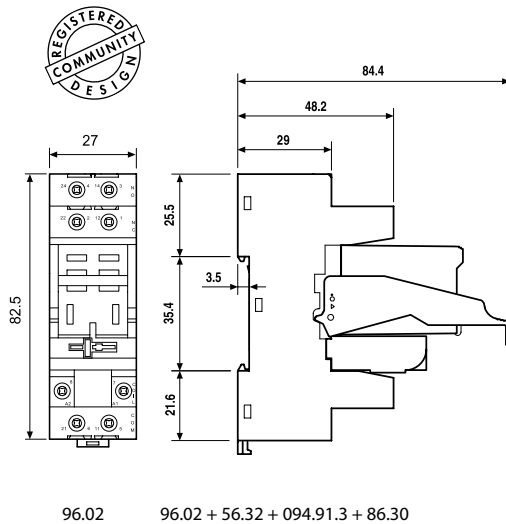
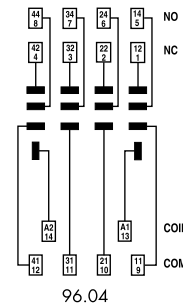
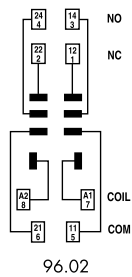

094.06



6-way jumper link for 96.02 socket	094.06 (blue)	094.06.0 (black)
Rated values	10 A - 250 V	

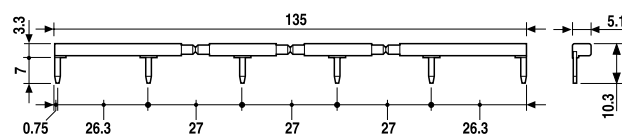

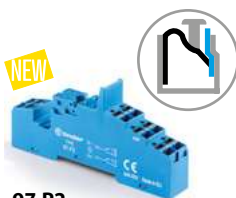

97.P2

Approvals
(according to type):



097.01

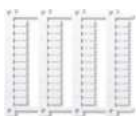

060.48

Push-in terminal socket panel or 35 mm rail (EN 60715) mount	97.P1	97.P2
For relay type	46.61	46.52
Accessories		
Plastic retaining and release clip (supplied with socket - packaging code SPA)		097.01
Metal retaining clip		097.71
Identification tag		095.00.4
8-way jumper link		097.58
2-way jumper link		097.52
2-way jumper link		097.42
Marker tag holder		097.00
Timer modules (see table below)		86.30
Sheet of marker tags for marker tag holder 097.00, 48 tags, 6 x 12 mm, for CEMBRE thermal transfer printers		060.48
Technical data		
Rated values	16 A-250 V AC	8 A-250 V AC
Dielectric strength	6 kV (1.2/50 μs) between coil and contacts	
Protection category	IP 20	
Ambient temperature	°C -40...+70 (see diagram L97)	
Wire strip length	mm 8	
Min. wire size for 97.P1 and 97.P2 socket	solid wire	stranded wire
	mm ² 0.5	0.5
	AWG 21	21
Max. wire size for 97.P1 and 97.P2 socket	solid wire	stranded wire
	mm ² 2 x 1.5 / 1 x 2.5	2 x 1.5 / 1 x 2.5
	AWG 2 x 18 / 1 x 14	2 x 18 / 1 x 14

L 97 - Rated current v ambient temperature

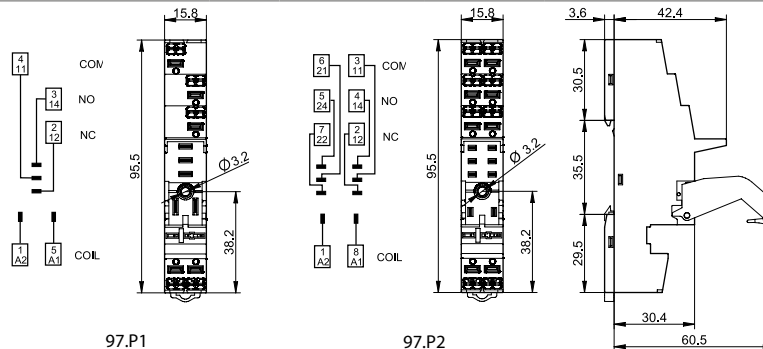
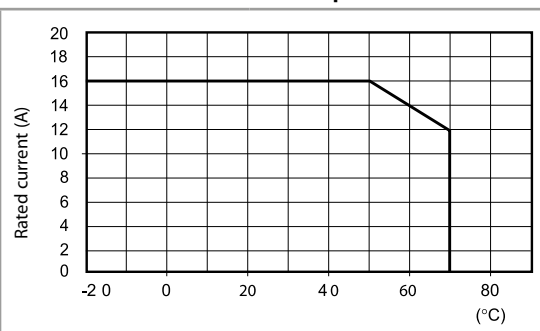

8-way jumper link for 97.P1 and 97.P2 sockets	097.58
Rated values	10 A - 250 V

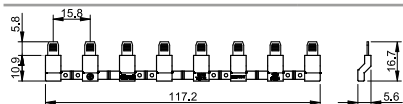

097.58

2-way jumper link for 97.P1 and 97.P2 sockets	097.52
Rated values	10 A - 250 V

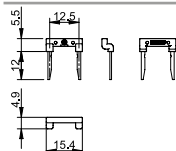

097.52

2-way jumper link for 97.P1 and 97.P2 sockets	097.42
Rated values	10 A - 250 V

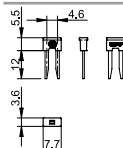

097.42

Marker tag holder for 95.P3 and 95.P5 sockets	097.00
--	--------

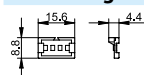

097.00

86 series timer modules	
(12...24)V AC/DC; Bi-function: AI, DI; (0.05 s...100 h)	86.30.0.024.0000
(110...125)V AC; Bi-function: AI, DI; (0.05 s...100 h)	86.30.8.120.0000
(230...240)V AC; Bi-function: AI, DI; (0.05 s...100 h)	86.30.8.240.0000



86.30

Approvals (according to type): **CE EAC cRU US**

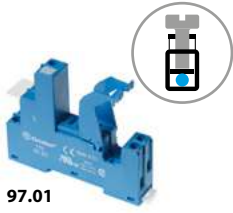

97.01
Approvals
(according to type):



097.01

Screw terminal socket	97.01	97.02
panel or 35 mm rail (EN 60715) mount	Blue	Blue
For relay type	46.61	46.52
Accessories		
Plastic retain and eject clip (supplied with socket - packaging code SPA)	097.01	
8-way jumper link	095.18 (blue)	095.18.0 (black)
Identification tag	095.00.4	
Timer modules	86.30	
Technical data		
Rated current	16 A - 250 V AC	8 A - 250 V AC
Dielectric strength	6 kV (1.2/50 μs) between coil and contacts	
Protection category	IP 20	
Ambient temperature	°C -40...+70 (see diagram L97)	
Screw torque	Nm	0.8
Wire strip length	mm	8
Max. wire size for 97.01 and 97.02 sockets	solid wire	stranded wire
	mm ²	1 x 6 / 2 x 2.5
	AWG	1 x 10 / 2 x 14

L 97 - Rated current v ambient temperature
(for 46.61 relay / 97.01 socket combination)

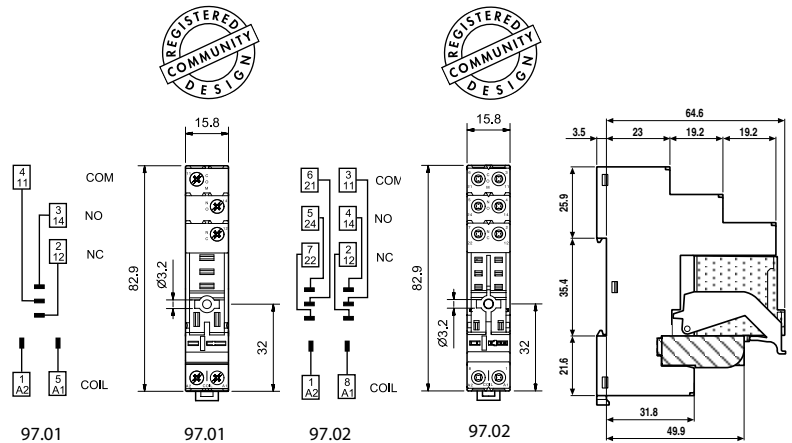
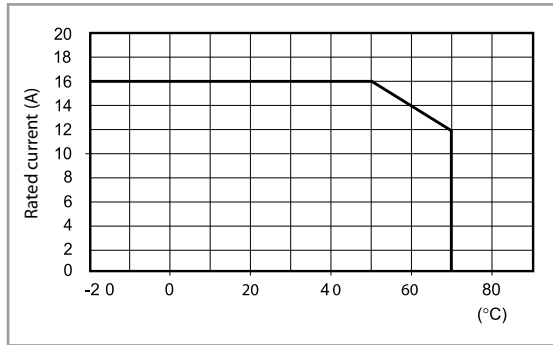

97.02 + 46.52 + 097.01
+ 86.30

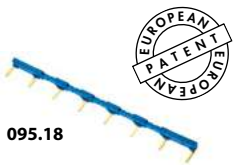

095.18



8-way jumper link for 97.01 and 97.02 sockets	095.18 (blue)	095.18.0 (black)
Rated values	10 A - 250 V	

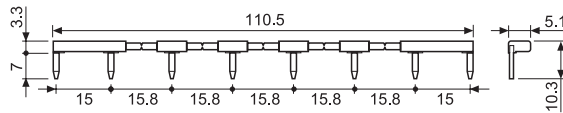



finder[®]
SWITCH TO THE FUTURE

Plug-in timers 8 A



Drying kilns



Industrial furnaces and ovens



Industrial washing machines



Hoists and cranes



Wood-processing machines



Medical and dentistry



88
SERIES

Multi-voltage and multi-function timer range
Front panel or socket mount

- 8 and 11 pin plug-in versions available
- Time scales from 0.05 s to 100 h
- "1 delayed contact + 1 instantaneous contact" version available (type 88.12)
- Front panel mounting fixing included
- 90 series sockets

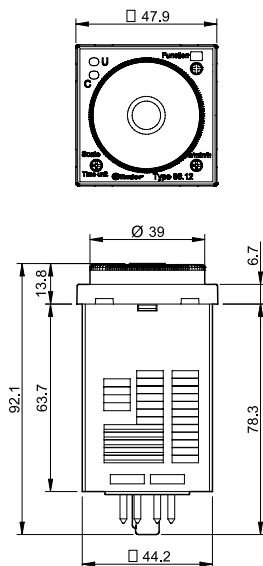

88.02



- Multi-function
- 11 pin
- Plug-in for use with 90 series sockets

- AI:** On-delay
- DI:** Interval
- GI:** Pulse delayed
- SP:** Symmetrical flasher (starting pulse off) without control signal

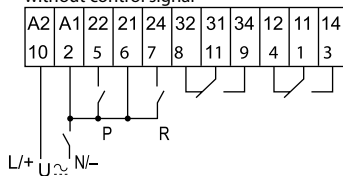

- BE:** Off-delay with control signal
- CEa:** On- and off-delay with control signal
- DE:** Interval with control signal on with control signal

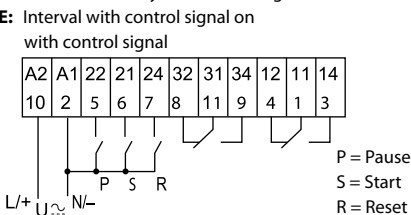

88.12



- Multi-function
- 8 pin, 2 timed contacts or 1 timed + 1 instantaneous contact
- Plug-in for use with 90 series sockets

- AI a:** On-delay (2 timed contacts)
- AI b:** On-delay (1 timed + 1 instantaneous contact)
- DI a:** Interval (2 timed contacts)
- DI b:** Interval (1 timed + 1 instantaneous contact)
- GI:** Pulse delayed
- SW:** Symmetrical flasher (starting pulse on)

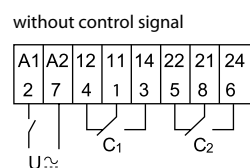

Contact specification

Contact configuration		2 CO (DPDT)	2 CO (DPDT)
Rated current/Maximum peak current	A	8/15	8/15
Rated voltage/Maximum switching voltage	V AC	250/400	250/400
Rated load AC1	VA	2000	2000
Rated load AC15 (230 V AC)	VA	400	400
Single phase motor rating (230 V AC)	kW	0.3	0.3
Breaking capacity DC1: 30/110/220 V	A	8/0.3/0.12	8/0.3/0.12
Minimum switching load	mW (V/mA)	300 (5/5)	300 (5/5)
Standard contact material		AgNi	AgNi

Supply specification

Nominal voltage (U _n)	V AC (50/60 Hz)	24...230	24...230
	V DC	24...230	24...230
Rated power AC/DC	VA (50 Hz)/W	2.5 (230 V)/1 (24 V)	2.5 (230 V)/1.5 (24 V)
Operating range	V AC	20.4...264.5	20.4...264.5
	V DC	20.4...264.5	20.4...264.5

Technical data

Specified time range		(0.05 s...5 h) - (0.05 s...10 h) - (0.05 s...50 h) - (0.05 s...100 h)	
Repeatability	%	± 1	± 1
Recovery time	ms	300	200
Minimum control impulse	ms	50	—
Setting accuracy-full range	%	± 3	± 3
Electrical life at rated load AC1	cycles	100 · 10 ³	100 · 10 ³
Ambient temperature range	°C	-10...+55	-10...+55
Protection category		IP 40	IP 40

Approvals (according to type)



Multi-voltage and mono-function timer range
Front panel or socket mount

- Asymmetrical flasher The ON and OFF time are independently adjustable
- 8 pin plug-in
- Time scales from 0.05 s to 300 h
- 2 contacts
- Front panel mounting fixing included
- 90 series sockets

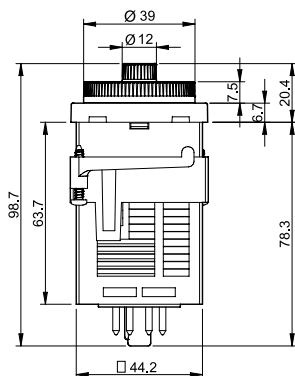
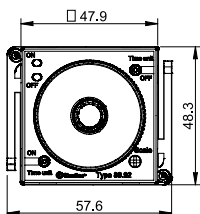

88.92 - 0000



- Mono-function
- 8 pin, 2 timed contacts
- Plug-in for use with 90 series sockets

PI: Asymmetrical flasher (starting pulse OFF)

without control signal

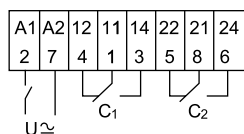

88.92 - 0001



- Mono-function
- 8 pin, 2 timed contacts
- Plug-in for use with 90 series sockets

LI: Asymmetrical flasher (starting pulse ON)

without control signal

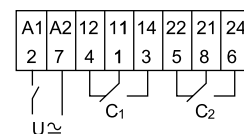

Contact specification

Contact configuration		2 CO (DPDT)	2 CO (DPDT)
Rated current/Maximum peak current	A	8/15	8/15
Rated voltage/ Maximum switching voltage	V AC	250/400	250/400
Rated load AC1	VA	2000	2000
Rated load AC15 (230 V AC)	VA	400	400
Single phase motor rating (230 V AC)	kW	0.3	0.3
Breaking capacity DC1: 30/110/220 V	A	8/0.3/0.12	8/0.3/0.12
Minimum switching load	mW (V/mA)	300 (5/5)	300 (5/5)
Standard contact material		AgNi	AgNi

Supply specification

Nominal voltage (U _N)	V AC (50/60 Hz)	12...240	12...240
	V DC	12...240	12...240
Rated power AC/DC	VA (50 Hz)/W	2.5 (230 V)/1.5 (24 V)	2.5 (230 V)/1.5 (24 V)
Operating range	V AC	10.8...264.5	10.8...264.5
	V DC	10.8...264.5	10.8...264.5

Technical data

Specified time range		See "Time Scale" page 5	See "Time Scale" page 5
Repeatability	%	± 1	± 1
Recovery time	ms	200	200
Minimum control impulse	ms	—	—
Setting accuracy-full range	%	± 1	± 1
Electrical life at rated load AC1	cycles	100 · 10 ³	100 · 10 ³
Ambient temperature range	°C	-10...+55	-10...+55
Protection category		IP 40	IP 40

Approvals (according to type)



Ordering information

Example: 88 series multi-function timer, 2 CO (DPDT) 8 A contacts, (24...230)V AC (50/60 Hz) and (24...230)V DC supply.

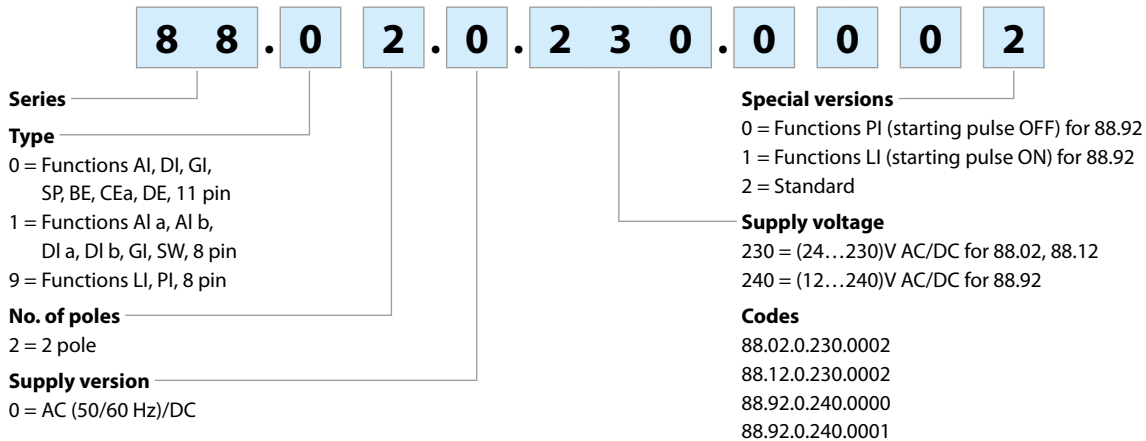

Technical data

EMC specifications

Type of test	Reference standard	88.02/88.12	88.92
Electrostatic discharge	contact discharge	EN 61000-4-2	4 kV
	air discharge	EN 61000-4-2	8 kV
Radio-frequency electromagnetic field (80 ÷ 1000 MHz)	EN 61000-4-3	10 V/m	10 V/m
Fast transients (burst) (5-50 ns, 5 kHz) on Supply terminals	EN 61000-4-4	2 kV	—
Surges (1.2/50 µs) on Supply terminals	common mode	EN 61000-4-5	2 kV
	differential mode	EN 61000-4-5	1 kV
Radio-frequency common mode (0.15 ÷ 80 MHz) on Supply terminals	EN 61000-4-6	3 V	—

Selection of: function, time scale and units

	88.02	88.12	88.92 - 0000	88.92 - 0001
Function	AI, DI, GI, SP, BE, CEa, DE	AI a, AI b, DI a, DI b, GI, SW	PI	LI
Time scale	0.5, 1, 5, 10		1.2, 3, 12, 30	
Unit of time	s (second), min (minute), h (hour), 10 h (10 hours)		s (second), 10 s (second x 10), min (minute), 10 min (minute x 10), h (hour), 10 h (hour x 10)	

Time scales

Full scale value for types 88.02, 88.12

D \ H	s	min	h	10 h
0.5	0.5 second	0.5 minute	0.5 hour	5 hour
1	1 second	1 minute	1 hour	10 hour
5	5 second	5 minute	5 hour	50 hour
10	10 second	10 minute	10 hour	100 hour

Full scale value for type 88.92

H \ D-E	s	10 s	min	10 min	h	10 h
1.2	1.2 second	12 second	1.2 minute	12 minute	1.2 hour	12 hour
3	3 second	30 second	3 minute	30 minute	3 hour	30 hour
12	12 second	120 second	12 minute	120 minute	12 hour	120 hour
30	30 second	300 second	30 minute	300 minute	30 hour	300 hour

NOTE: time scales and functions must be set before energising the timer.

LED/visual indication

Types 88.02, 88.12

A	Yellow LED: power ON (U)
B	Red LED: timing in progress (C)
C	Unit of time selected
D	Time scale selector
E	Function selector
F	Function selected
G	Time scale selected
H	Unit of time selector

Type 88.92

A	Red LED: pulse ON (T1)
B	Green LED: pulse OFF (T2)
C	Red timing regulator: T1 time setting
D	Unit of time selector: T1 (ON)
E	Unit of time selector: T2 (OFF)
F	Green timing regulator: T2 time setting
G	Time scale selected
H	Time scale selector

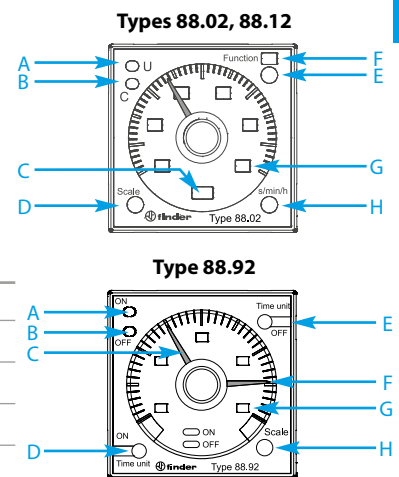

Functions for types 88.02, 88.12

U = Supply Voltage
S = Signal switch
P = Pause
R = Reset
— = Output Contact

	LED (yellow)	LED (red)	Supply voltage	NO output contact	Open	Closed
			OFF	Open	x1 - x4	x1 - x2
			ON	Open	x1 - x4 x1 - x2	x1 - x2 x1 - x4
			ON	Open (timing in progress)	x1 - x4	x1 - x2
			ON	Closed	x1 - x2	x1 - x4

Wiring diagram

Type 88.02

without control signal

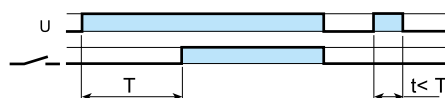
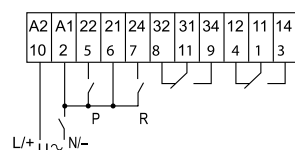

(AI) On-delay.

Apply power to timer. Output contacts transfer after preset time has elapsed. Reset occurs when power is removed.

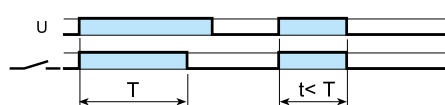

(DI) Interval.

Apply power to timer. Output contacts transfer immediately. After the preset time has elapsed, contacts reset.



(GI) Pulse delayed.

Apply power to timer. Output contacts transfer after preset time has elapsed. Reset occurs after a fixed time of 0.5 s.

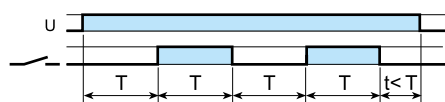

(SP) Symmetrical flasher (starting pulse off).

Apply power to timer. First transfer of contact occurs after preset time has elapsed. The timer now cycles between OFF and ON as long as power is applied. The ratio is 1:1 (time on = time off).

with control signal

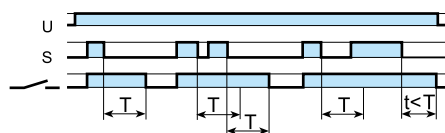
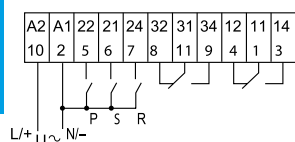

(BE) Off-delay with control signal.

Power is permanently applied to the timer. The output contacts transfer immediately on closure of the Signal Switch (S). Opening the Signal Switch initiates the preset delay, after which time the output contacts reset.

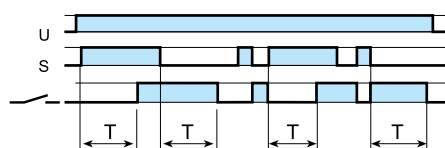

(CEa) On- and off-delay with control signal.

Power is permanently applied to the timer. Closing the Signal Switch (S) initiates the preset delay, after which time the output contacts transfer. Opening the Signal switch initiates the same preset delay, after which time the output contacts reset.

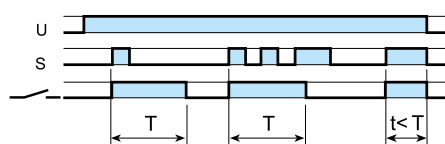

(DE) Interval with control signal on.

Power is permanently applied to the timer. On momentary or maintained closure of Signal Switch (S), the output contacts transfer, and remain so for the duration of the preset delay, after which they reset.

RESET (R)

A momentary closure of the reset switch (2-7) will reset the timer. Longer term closure of the reset switch will hold the timer in the reset state. This is applicable for all functions.

PAUSE (P)

Closure of the pause switch (2-5) will immediately halt the timing process, but the elapsed time will be retained, and the current state of the output contacts will be maintained.

On opening of the pause switch, timing resumes from the retained value. This is applicable for all functions.

Functions for type 88.12

Wiring diagram

without control signal

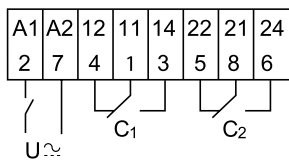

Type 88.12

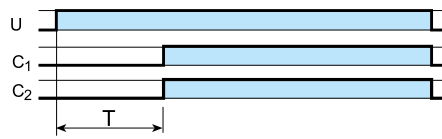

(AI a) On-delay (2 timed contacts).

Apply power to timer.
Contacts (C₁ and C₂) transfer after preset time has elapsed.
Reset occurs when power is removed.

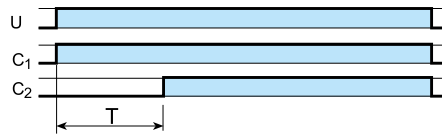

(AI b) On-delay

(1 timed contact + 1 instantaneous contact).

Apply power to timer. Output contact (C₁) transfers immediately.
Contact (C₂) transfers after the preset time has elapsed.
Reset occurs when power is removed.

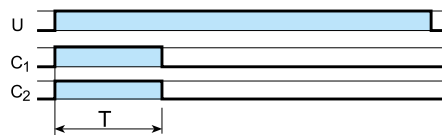

(DI a) Interval (2 timed contacts).

Apply power to timer.
Output contacts (C₁ and C₂) transfer immediately.
After preset time has elapsed, the contacts reset.

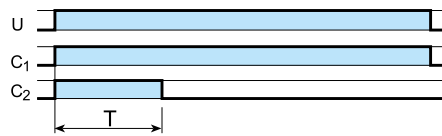

(DI b) Interval (1 timed contact + 1 instantaneous contact).

Apply power to timer. Output contacts (C₁ and C₂) transfer immediately. After preset time has elapsed, the contact (C₂) resets.
Contact (C₁) resets when power is removed.

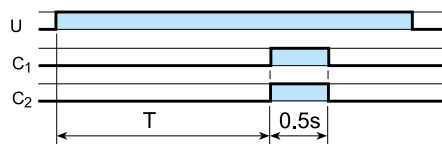

(GI) Pulse delayed.

Apply power to timer. Output contacts transfer after preset time has elapsed. Reset occurs after a fixed time of 0.5 s.

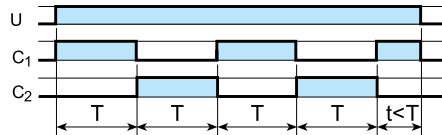

(SW) Symmetrical flasher (starting pulse on).

Apply power to timer. Output contacts transfer immediately and cycle between ON and OFF for as long as power is applied.
The ratio is 1:1 (time on = time off).

Functions for type 88.92

U = Supply Voltage

	LED ON (red)	LED OFF (green)	Supply voltage	Contact	
				Open	Closed
_____	_____	_____	OFF	11 - 14 21 - 24	11 - 12 21 - 22
		_____	ON	11 - 12 21 - 22	11 - 14 21 - 24
_____	_____		ON	11 - 14 21 - 24	11 - 12 21 - 22

Wiring diagram

without control signal

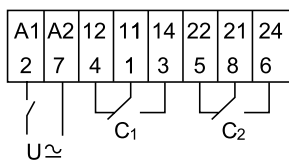

Type 88.92

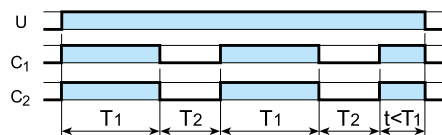

(LI) Asymmetrical flasher (starting pulse ON).

Apply power to timer. Output contacts transfer immediately and cycle between ON and OFF for as long as power is applied. The ON and OFF times are independently adjustable.

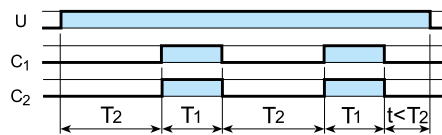

(PI) Asymmetrical flasher (starting pulse OFF).

Apply power to timer. Output contacts transfer after time T₂ has elapsed and cycle between OFF and ON for as long as power is applied. The ON and OFF times are independently adjustable.



90.21

Approvals
(according to type):



Screw terminal (Box clamp) socket panel or 35 mm rail (EN 60715) mount	90.20 Blue	90.20.0 Black	90.21 Blue	90.21.0 Black
For timer type	88.12, 88.92		88.02	
Technical data				
Rated values	10 A - 250 V			
Dielectric strength	2 kV AC			
Protection category	IP 20			
Ambient temperature	°C -40...+70			
Screw torque	Nm 0.5			
Wire strip length	mm 10			
Max. wire size for 90.20 and 90.21 sockets	solid wire		stranded wire	
	mm ²	1 x 6 / 2 x 2.5		1 x 6 / 2 x 2.5
	AWG	1 x 10 / 2 x 14		1 x 10 / 2 x 14

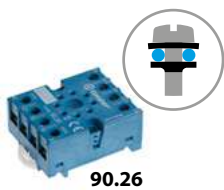
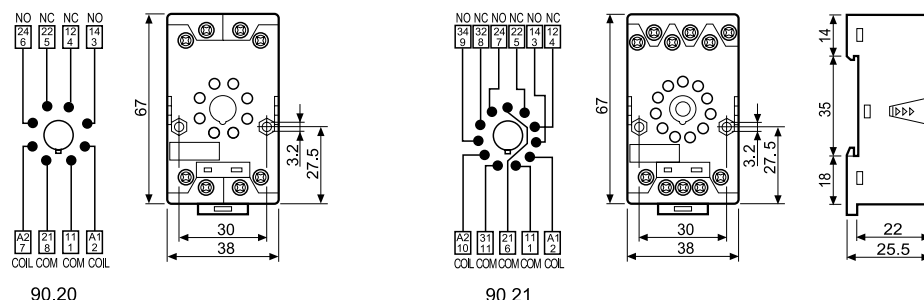

90.26

Approvals
(according to type):



Screw terminal (Box clamp) socket panel or 35 mm rail (EN 60715) mount	90.26 Blue	90.26.0 Black	90.27 Blue	90.27.0 Black
For timer type	88.12, 88.92		88.02	
Technical data				
Rated values	10 A - 250 V			
Dielectric strength	2 kV AC			
Protection category	IP 20			
Ambient temperature	°C -40...+70			
Screw torque	Nm 0.8			
Wire strip length	mm 10			
Max. wire size for 90.26 and 90.27 sockets	solid wire		stranded wire	
	mm ²	1 x 4 / 2 x 2.5		1 x 4 / 2 x 2.5
	AWG	1 x 12 / 2 x 14		1 x 12 / 2 x 14

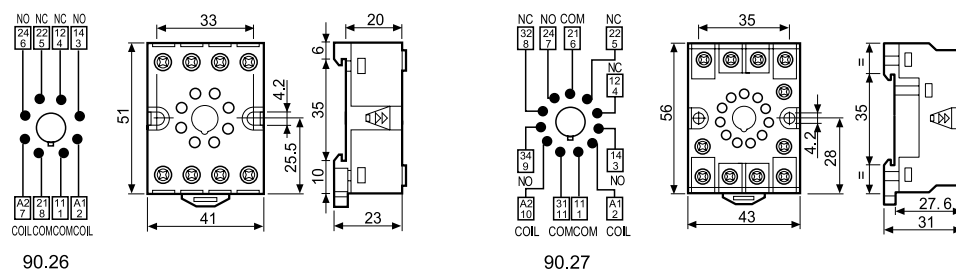

90.13.4

Approvals
(according to type):



Sockets 8-11 pin backwired with solder terminals	90.12.4 (black)	90.13.4 (black)
For timer type	88.12, 88.92	
Technical data		
Rated values	10 A - 250 V	
Dielectric strength	2 kV AC	
Ambient temperature	°C -40...+70	

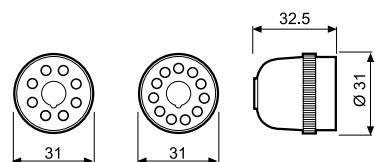

90.12.4

90.13.4



finder[®]
SWITCH TO THE FUTURE

Timed socket for 34 series



Hoists and cranes



Packaging machines



Traffic light controls



Bottling plant



Carousel warehouses



Control panels



Panels for electrical distribution



Labelling machines

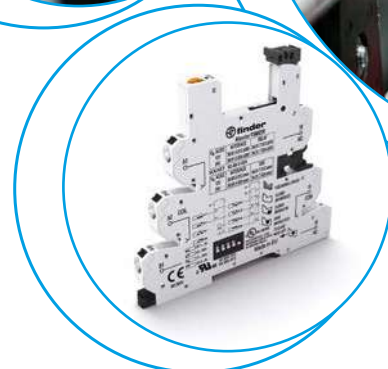
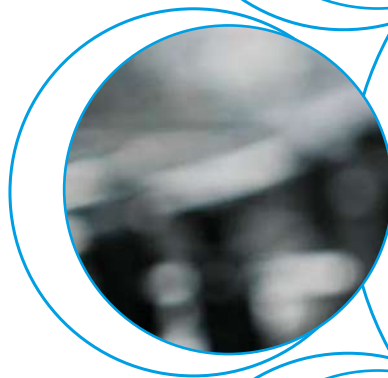
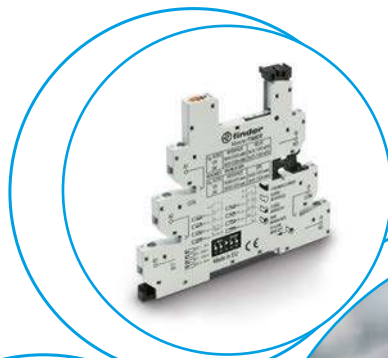

93
SERIES

Slim timed sockets for 34 series, 6.2 mm wide

- Timer adjustment via top mounted rotary knob accessible after assembly
- Control signal terminal
- DIP-switch for selection of 4 time scales and 8 functions
- Output with fuse module option
- EMR and SSR: 12 to 24 V AC/DC supply
- Screw terminal and push-in terminal

93.68
Screw terminals



93.69
Push-in terminal



- Time scale: from 0.1 s to 6 h
- Multi-function
- For use with 34.51 (EMR) and 34.81 (SSR) relays
- Screw terminal and push-in terminal

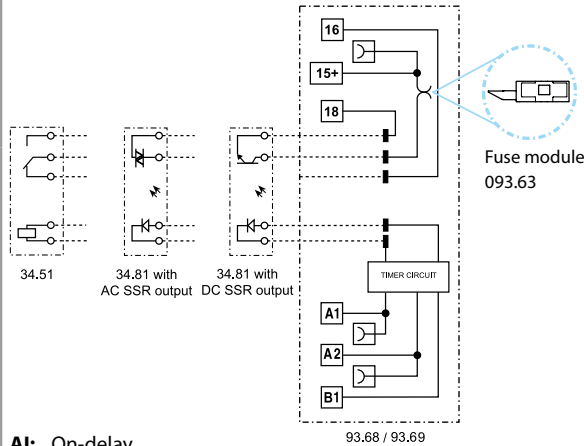

- A1:** On-delay
- D1:** Interval
- G1:** Pulse (0.5 s) delayed
- SW:** Symmetrical flasher (starting pulse on)
- BE:** Off-delay with control signal
- CE:** On- and off-delay with control signal
- DE:** Interval with control signal on
- EE:** Interval with control signal off

For outline drawing see page 5

Contact specification

Contact configuration	
Rated current/Maximum peak current	A
Rated voltage/ Maximum switching voltage	V AC
Rated load AC1	VA
Rated load AC15 (230 V AC)	VA
Single phase motor rating (230 V AC)	kW
Breaking capacity DC1: 30/110/220 V	A
Minimum switching load	mW (V/mA)
Standard contact material	

See 34.51 and 34.81 relays

Supply specification

Nominal voltage (U _N)	V AC (50/60 Hz)/DC
Rated power AC/DC	VA/W
Operating range	V AC (50/60 Hz)/DC

12...24

See coils specifications page 4

9.6...26.4

Technical data

Specified time range	
Repeatability	%
Recovery time	ms
Setting accuracy - full range	%
Electrical life at rated load in AC1	cycles
Ambient temperature range	°C
Protection category	

(0.1...3)s, (3...60)s, (1...20)min, (0.3...6)h

± 1

≤ 50

5

See 34.51 (EMR) and 34.81 (SSR) relays

-20...+50

IP 20

Approvals (according to type)



Ordering information

Example: type 93.68 multi-function timer module for 34 series relay, screw terminals, (12...24)V AC/DC supply voltage.

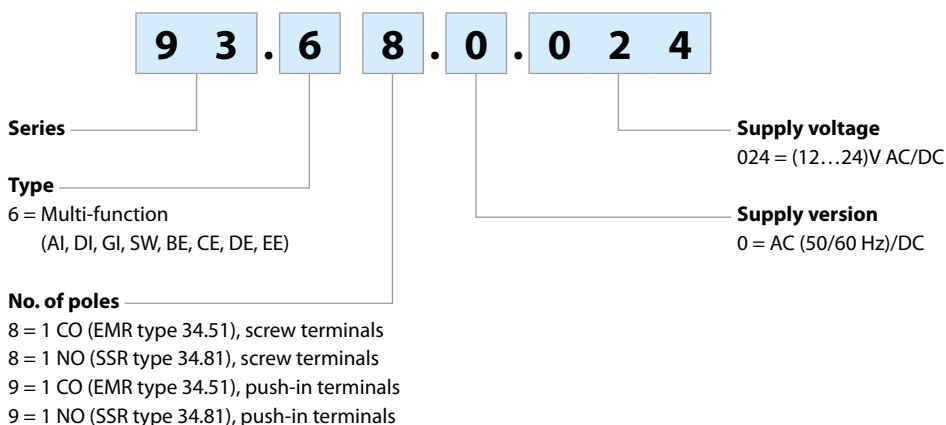

Combinations

Output	Supply voltage	Type of relay	Type of socket, screw terminals
1 pole 6 A, electromechanical relay	12 V AC/DC	34.51.7.012.0010	93.68.0.024
1 pole 6 A, electromechanical relay	24 V AC/DC	34.51.7.024.0010	93.68.0.024
1 output 6 A/24 V DC, solid state relay	12 V AC/DC	34.81.7.012.9024	93.68.0.024
1 output 2 A/240 V AC, solid state relay	12 V AC/DC	34.81.7.012.8240	93.68.0.024
1 output 6 A/24 V DC, solid state relay	24 V AC/DC	34.81.7.024.9024	93.68.0.024
1 output 2 A/240 V AC, solid state relay	24 V AC/DC	34.81.7.024.8240	93.68.0.024
Output	Supply voltage	Type of relay	Type of socket, push-in terminals
1 pole 6 A, electromechanical relay	12 V AC/DC	34.51.7.012.0010	93.69.0.024
1 pole 6 A, electromechanical relay	24 V AC/DC	34.51.7.024.0010	93.69.0.024
1 output 6 A 24 V DC, solid state relay	12 V AC/DC	34.81.7.012.9024	93.69.0.024
1 output 2 A 240 V AC, solid state relay	12 V AC/DC	34.81.7.012.8240	93.69.0.024
1 output 6 A 24 V DC, solid state relay	24 V AC/DC	34.81.7.024.9024	93.69.0.024
1 output 2 A 240 V AC, solid state relay	24 V AC/DC	34.81.7.024.8240	93.69.0.024

Note: Although the timer socket covers both 12 and 24 V supplies, it must be combined with the appropriate 12 V or 24 V relay; resulting in a combination suitable for just a single supply voltage.

Technical data

EMC specifications

Type of test	Reference standard		
Electrostatic discharge	contact discharge	EN 61000-4-2	4 kV
	air discharge	EN 61000-4-2	8 kV
Radio-frequency electromagnetic field	(80 ÷ 1000 MHz)	EN 61000-4-3	10 V/m
	(1400 ÷ 2700 MHz)	EN 61000-4-3	10 V/m
Fast transients (burst) (5-50 ns, 5 and 100 kHz)	on Supply terminals	EN 61000-4-4	4 kV
	on control signal terminals	EN 61000-4-4	4 kV
Surges (1.2/50 µs) on supply and control signal terminals	common mode	EN 61000-4-5	2 kV
	differential mode	EN 61000-4-5	0.8 kV
Radio-frequency common mode (0.15 ÷ 80 MHz)	on Supply terminals	EN 61000-4-6	10 V
	on control signal terminals	EN 61000-4-6	3 V
Radiated and conducted emission	EN 55022		class B

Other data

Current absorption on signal control (B1)	mA	< 1.7 (12 V) - < 3.5 (24 V)	
Bounce time (EMR) : NO/NC	ms	1/6	
Vibration resistance (EMR, 10...55 Hz): NO/NC	g	10/5	
Power lost to the environment	without contact current	W	0.3
	with rated current	W	0.8

Terminals

		Solid and stranded cable	
		Screw terminals	Push-in terminals
Wire strip length	mm	10	8
 Screw torque	Nm	0.5	—
Max. wire size	mm ²	1 x 2.5 / 2 x 1.5	1 x 2.5
	AWG	1 x 14 / 2 x 16	1 x 14
Min. wire size	mm ²	1 x 0.5	1 x 0.5
	AWG	1 x 21	1 x 21

Input specifications

Input data AC/DC timer

Nominal voltage U_N	Operating range (AC/DC)		Must drop-out voltage U_r	Rated input current at U_N		Rated power at U_N	
	U_{min}	U_{max}		DC	AC	DC	AC
V	V	V	V	mA	mA	mA	mA
12	9.6	13.2	1.2	15	23	0.2	0.3/0.2
24	19.2	26.4	2.4	11	19	0.25	0.4/0.3

Outline drawing

93.68
Screw terminals

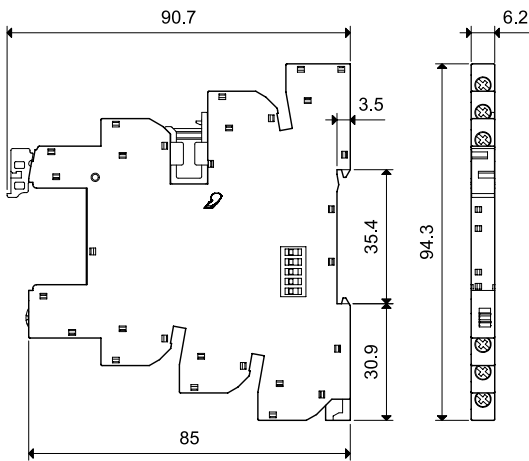

93.69
Push-in terminal

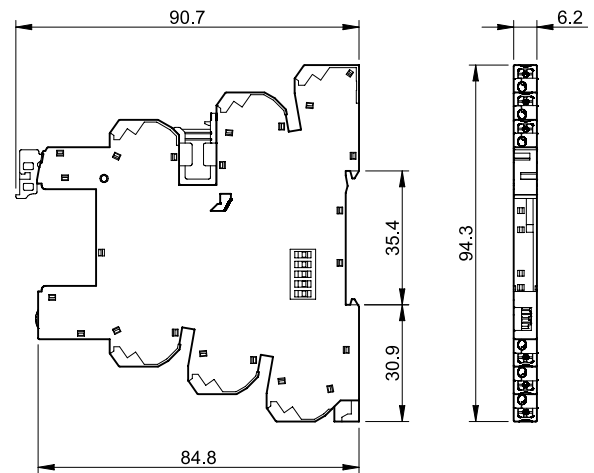

Times scales

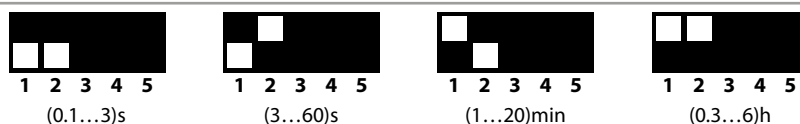

Functions

LED	Supply voltage	NO contact/output
	OFF	Open
	ON	Open
	ON	Open (timing to close in progress)
	ON	Closed

Wiring diagram

U = Supply voltage S = Signal switch = Output Contact

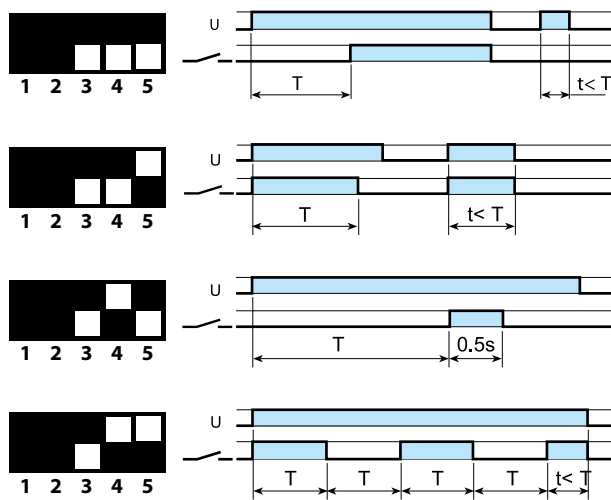
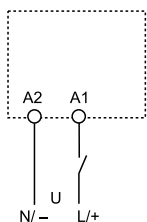

(AI) On-delay
Apply power to timer. Output contacts transfer after preset time has elapsed. Reset occurs when power is removed.

(DI) Interval
Apply power to timer. Output contacts transfer immediately. After the preset time has elapsed, contacts reset.

(GI) Pulse (0.5 s) delayed
Apply power to timer. Output contacts transfer after preset time has elapsed. Reset occurs after a fixed time of 0.5 s.

(SW) Symmetrical flasher (starting pulse on)
Apply power to timer. Output contacts transfer immediately and cycle between ON and OFF for as long as power is applied. The ratio is 1:1 (time on = time off).

H

With control signal

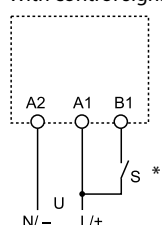

* With DC supply, positive polarity has to be connected to B1 terminal (according to EN 60204-1).

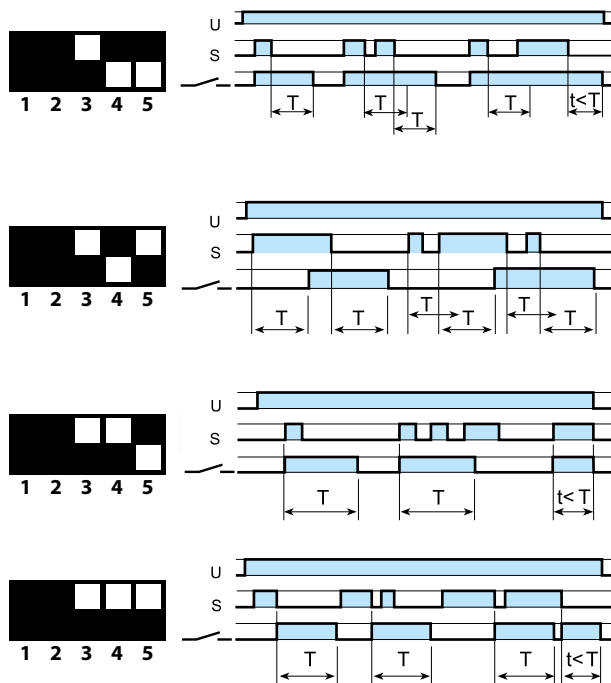

(BE) Off-delay with control signal
Power is permanently applied to the timer. The output contacts transfer immediately on closure of the Signal Switch (S). Opening the Signal Switch initiates the preset delay, after which time the output contacts reset.

(CE) On- and off-delay with control signal
Power is permanently applied to the timer. Closing the Signal Switch (S) initiates the preset delay, after which time the output contacts transfer. Opening the Signal switch initiates the same preset delay, after which time the output contacts reset.

(DE) Interval with control signal on
Power is permanently applied to the timer. On momentary or maintained closure of Signal Switch (S), the output contacts transfer, and remain so for the duration of the preset delay, after which they reset.

(EE) Interval with control signal off
Power is permanently applied to the timer. On opening of the Signal Switch (S) the output contacts transfer, and remain so for the duration of the preset delay, after which they reset.

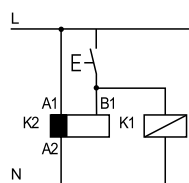

• Possible to control an external load, such as another relay coil or timer, connected to the control signal terminal B1.

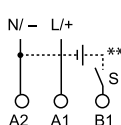

** A voltage other than the supply voltage can be applied to the command Start (B1), example:
A1 - A2 = 24 V AC
B1 - A2 = 12 V DC

Accessories

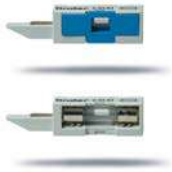

093.63

Approvals
(according to type):



Output fuse module	093.63
---------------------------	--------

- For 5 x 20 mm fuses up to 6 A, 250 V
- Easy visibility of the fuse condition through the window
- Quick connection to socket

Notes

Safety: Because the output circuit can be reinstated, even with the fuse removed, it is important not to consider the removal of the fuse as a "safety disconnect". Always isolate elsewhere before working on the circuit.

UL: According to UL508A, the fuse module cannot be installed in power circuits (in which it is mandatory that a fuse certified according to UL category JDDZ be fitted). However, where the MasterInterface is connected as an output interface to a PLC no such restrictions apply, and the fuse module can be usefully employed.

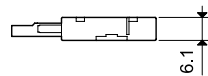
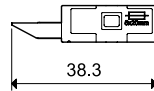

093.16



093.16.0



093.16.1

Approvals
(according to type):



16-way jumper link	093.16 (blue)	093.16.0 (black)	093.16.1 (red)
---------------------------	---------------	------------------	----------------

Rated values	6 A - 250 V
--------------	-------------

Possibility of multiple connection, side by side

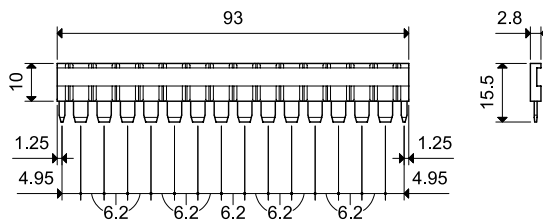

093.60



Dual-purpose plastic separator (1.8 mm or 6.2 mm separation)	093.60
---	--------

- By breaking off the protruding ribs (by hand), the separator becomes only 1.8 mm thick; useful for the visual separation of different groups of interfaces, or necessary for the protective separation of different voltages of neighbouring interfaces, or for the protection of cut ends of jumper links.

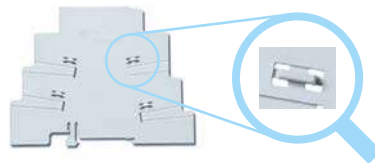

- Leaving the ribs in place provides 6.2 mm separation. Simply cutting (with scissors) the relevant segment(s) permits the interconnection across the separator of 2 different groups of interface relays, using the standard jumper link.

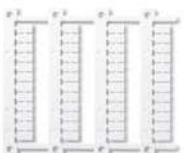

060.48

Sheet of marker tags, plastic, 48 tags, 6 x 12 mm, for CEMBRE thermal transfer printers	060.48
--	--------

Accessories



093.62

Terminal doubler (for socket Push-in only)	093.62	
Total load	6 A - 300 V	
Max. wire size	Solid and stranded cable	
	mm ²	2 x 1.5
	AWG	2 x 16



093.68.14.1

Approvals
(according to type):



MasterADAPTER	093.68.14.1	
----------------------	-------------	--

The **MasterADAPTER** permits the easy connection of A1/A2 terminals of up to **MasterINTERFACE** modules to PLC outputs via a 14-Pole ribbon cable, plus simple 2-wire power supply connection.

Technical data		
Rated current (per signal path)	A	1
Minimum required supply power	W	3
Nominal voltage (U _N)	V DC	24
Operating range	(0.8...1.1)U _N	
Control logic	Positive switching (to A1)	
Power supply status indication	Green LED	
Ambient temperature range	°C	-40...+70

Terminals for 24 V control logic		
Type of connector	14 pole, according to IEC 60603-13	

Terminals for 24 V power supply			
Wire strip length	mm	9.5	
 Screw torque	Nm	0.5	
Max. wire size	solid wire	mm ²	1 x 4 / 2 x 1.5
		AWG	1 x 12 / 2 x 16
	stranded wire	mm ²	1 x 2.5 / 2 x 1.5
		AWG	1 x 14 / 2 x 16



Connected
MasterADAPTER



finder[®]
SWITCH TO THE FUTURE

Light dependent relays 12 - 16 A



Garden and
night lighting



Shop displays



Lighting for
parks



Streetlights
and car park
lighting



10
SERIES

Relays for automatic control of lighting according to the ambient light level

Integral light sensor

For pole or wall mounting

10.32 - 2 NO 16 A output contacts

10.41 - 1 NO 16 A output contact

- Double pole Live and Neutral switching possible with the 10.32
- Sensitivity adjustment from 1 to 80 lux
- Cadmium free contact material
- Cadmium free light sensor (IC photo diode)
- Electronic circuit - transformer isolated
- Italian Patent "light feedback compensation" innovative principle
Compatible with slow starting gas discharge lamps (up to 10 minutes)
- For the first 3 working cycles the delay time (On and Off) is reduced to zero in order to aid installation
- Available for supply 230 and 120 V AC (50/60 Hz)

10.32



- Double pole switching - 2 NO 16 A for Live and Neutral switching

10.41



- Single pole switching - 1 NO 16 A for Live switching

For outline drawing see page 8

Contact specification

Contact configuration		2 NO (DPST-NO)		1 NO (SPST-NO)	
Rated current/Maximum peak current	A	16/30 (120 A - 5 ms)		16/30 (120 A - 5 ms)	
Rated voltage/Maximum switching voltage	V AC	120/—	230/—	120/—	230/—
Rated load AC1	VA	1900	3700	1900	3700
Rated load AC15	VA	400	750	400	750
Rated current AC5a	A	—	5	—	5
Nominal lamp rating:					
230 V incandescent/halogen W		—	2300	—	2000
fluorescent tubes with electronic ballast W		600	1200	500	1000
fluorescent tubes with electromechanical ballast W		450	850	400	750
CFL W		250	500	200	400
230 V LED W		—	500	—	400
LV halogen or LED with electronic ballast W		250	500	200	400
LV halogen or LED with electromechanical ballast W		500	1000	400	800
Minimum switching load	mW (V/mA)	1000 (10/10)		1000 (10/10)	
Standard contact material		AgSnO ₂		AgSnO ₂	
Supply specification					
Nominal voltage (U _N)	V AC (50/60 Hz)	120	230	120	230
	V DC	—		—	
Rated power AC/DC	VA (50 Hz)/W	2/—		2/—	
Operating range	AC (50 Hz)	(0.8...1.1)U _N		(0.8...1.1)U _N	
	DC	—		—	
Technical data					
Electrical life at rated load in AC1	cycles	100 · 10 ³		100 · 10 ³	
Threshold setting	lx	1...80		1...80	
Preset threshold	lx	10		10	
Delay time: switching ON/OFF	s	15/30		15/30	
Ambient temperature range	°C	-30...+70		-30...+70	
Protection category		IP 54		IP 54	
Approvals (according to type)					

Relays for automatic control of lighting according to the ambient light level
Integral light sensor
For pole or wall mounting
10.42 - Two independent 16 A outputs with individual lux setting
10.51 - Miniature single 12 A 1 NO output
10.61 - Mounting on street light body

- Sensitivity adjustment from 1 to 80 lux
- Fixed sensitivity 10 lux ($\pm 20\%$) - (10.61 type)
- Cadmium free contact material
- Cadmium free light sensor (IC photo diode)
- Electronic circuit - transformer isolated (10.42 type)
- Italian Patent "light feedback compensation" innovative principle (10.51 type)
- For the first 3 working cycles the delay time (On and Off) is reduced to zero in order to aid installation
- Available for supply 230 and 120 V AC (50/60 Hz)
- Prewired with silicone wire, 500 mm length (10.61 type)

10.42

- Two independent outputs - 2 NO 16 A

10.51



- Single pole switching - 1 NO 12 A
- Miniature size

10.61

- Single pole switching - 1 NO 16 A

For outline drawing see page 8

Contact specification

Contact configuration		2 NO (DPST-NO)		1 NO (SPST-NO)		1 NO (SPST-NO)	
Rated current/Maximum peak current	A	16/30 (120 A - 5 ms)		12/25 (80 A - 5 ms)		16/30 (120 A - 5 ms)	
Rated voltage/Maximum switching voltage	V AC	120/—	230/—	120/—	230/—	230/—	
Rated load AC1	VA	1900	3700	1400	2760	3700	
Rated load AC15	VA	400	750	300	600	750	
Rated current AC5a	A	—	5	—	—	5	
Nominal lamp rating:							
230 V incandescent/halogen W		—	2000	—	1200	2000	
fluorescent tubes with electronic ballast W		500	1000	300	600	1000	
fluorescent tubes with electromechanical ballast W		400	750	200	400	750	
CFL W		200	400	200	350	400	
230 V LED W		—	400	—	350	400	
LV halogen or LED with electronic ballast W		200	400	200	350	400	
LV halogen or LED with electromechanical ballast W		400	800	300	600	800	
Minimum switching load	mW (V/mA)	1000 (10/10)		1000 (10/10)		1,000 (10/10)	
Standard contact material		AgSnO ₂		AgSnO ₂		AgSnO ₂	
Supply specification							
Nominal voltage (U _N)	V AC (50/60 Hz)	120	230	120	230	230	
	V DC	—		—		—	
Rated power AC/DC	VA (50 Hz)/W	2/—		1.5/—		2.5/—	
Operating range	AC (50 Hz)	(0.8...1.1)U _N		(0.8...1.1)U _N		(0.8...1.1)U _N	
	DC	—		—		—	
Technical data							
Electrical life at rated load in AC1	cycles	100 · 10 ³		100 · 10 ³		100 · 10 ³	
Threshold setting	lx	1...80		1...80		10	
Preset threshold	lx	10		10		10	
Delay time: switching ON/OFF	s	15/30		15/30		15/30	
Ambient temperature range	°C	-30...+70		-30...+70		-30...+70	
Protection category		IP 54		IP 54		IP 54	
Approvals (according to type)							

Ordering information

Example: 10 series light dependent relay, 2 NO (DPST-NO) 16 A contact, screw terminal connections, 230 V AC supply.



Series

Type

32 = Double output - 2 NO 16 A

41 = Single output - 1 NO 16 A

42 = Two independent outputs - 2 NO 16 A

51 = Single output - 1 NO 12 A

61 = Mounting on street light body - 1 NO 16 A

Supply voltage

120 = 120 V

230 = 230 V

Supply version

8 = AC (50/60 Hz)

Technical data

Insulation	10.32 / 41 / 42		10.51		10.61
Dielectric strength between open contacts V AC	1000		1000		1000
Conducted disturbance immunity					
Surge (1.2/50 µs) on L and N (differential mode) kV	4		4		6
Other data					
Cable grip Ø mm	(8.9...12)		(7.5...9)		—
Screw torque Nm	0.8		0.8		—
Max. wire size	solid cable	stranded cable	solid cable	stranded cable	—
	mm ²	1 x 6 / 2 x 4	1 x 6 / 2 x 2.5	1 x 6 / 2 x 4	1 x 4 / 2 x 2.5
	AWG	1 x 10 / 2 x 12	1 x 10 / 2 x 14	1 x 10 / 2 x 12	1 x 12 / 2 x 14
Output wires					
Material	—		—		Silicone rubber UV resistant
Size mm ²	—		—		1.5
Length mm	—		—		500, ends-ferruled
Rated insulation voltage kV	—		—		0.6/1
Max temperature °C	—		—		120

Functions

LED*	10.32 / 10.41 / 10.42		10.51	
	Supply voltage	NO output contact	Supply voltage	NO output contact
	OFF	Open	OFF or ON	Open
	ON	Open	ON	Closed
	ON	Open (Timing in Progress)	ON	Open (Timing in Progress)
	ON	Closed	—	—

* The LED is located under the terminal cover, close to the Lux adjustment knob. It indicates the contact status and assists in the test and setting of the correct light threshold level.

Wiring diagrams

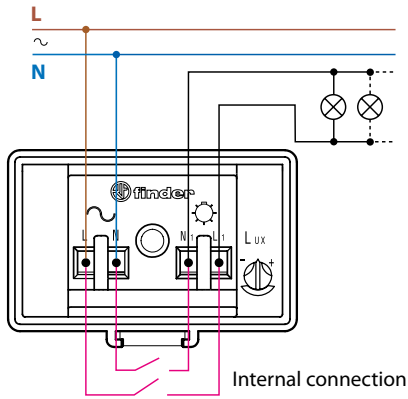

Type 10.32

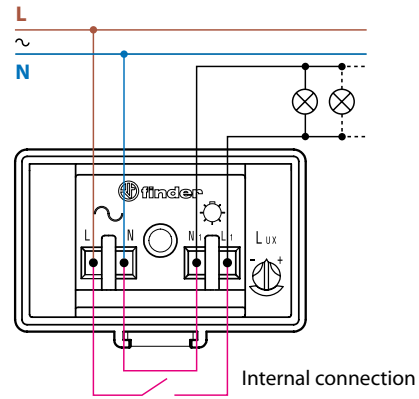

Type 10.41

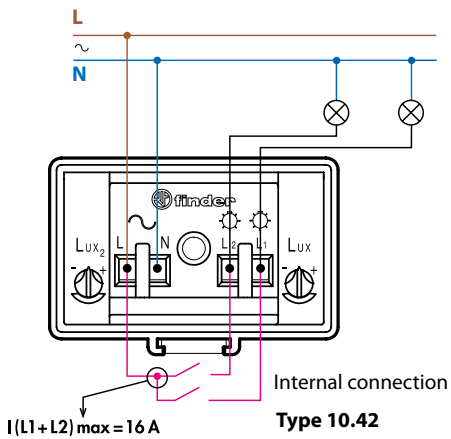

Type 10.42

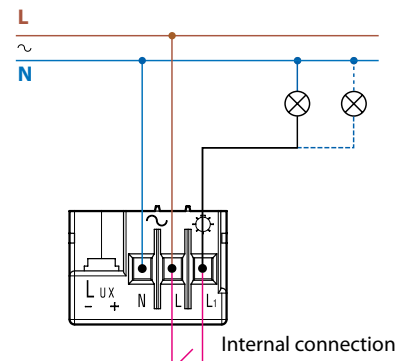

Type 10.51

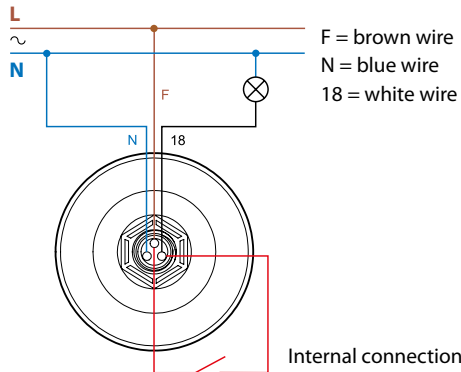

Type 10.61

Advantage of the "light feedback compensation" principle

Light dependent relay where the lighting being controlled does not influence the light level seen by the light sensor

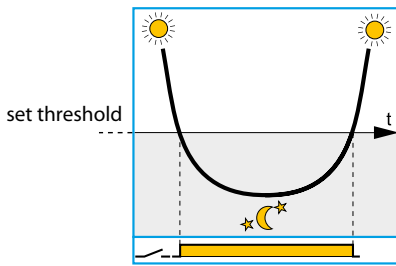

Correct functioning - provided the sensor can be shielded from the effects of the controlled lighting switching On and Off

Traditional light dependent relay where the lighting being controlled influences the light level seen by the light sensor

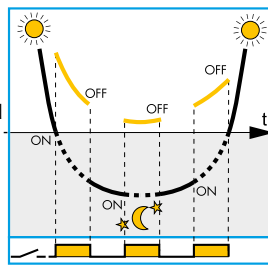

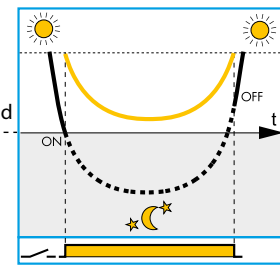

Incorrect functioning where the lamps cycle between On and Off, because their effect is being detected by the light sensor

Type 10.32, 10.41 and 10.51 light dependent relay with "light feedback compensation"



The innovative principle of "light feedback compensation" avoids the annoying and damaging effects of the lamps repeatedly "hunting" between On and Off, due to poor installation

recalculated OFF threshold

 Ambient light level as measured by the light dependent relay's integral light sensor.
 Ambient light + controlled light level as measured by the light dependent relay's integral light sensor.

Notes

1. It is good practice to try to achieve a correct installation where the light emitted from the lamp(s) does not influence the light level seen by the sensor, although the "light feedback compensation" principle will help when this is not fully achievable. In this case it should be appreciated that the "light feedback compensation" principle may delay slightly the time of Switch Off - beyond the ideal.
2. The compensation principle is not effective where the combined effect of the ambient light and the controlled lighting exceeds 120 lux.
3. The 10.32 and 10.41 types are compatible with gas discharge lamps that attain full output within 10 minutes, since the electronic circuit monitors lamps' light output over a 10 minutes period to achieve a true assessment of its contribution to the overall lighting level.

Outline drawings

Type 10.32

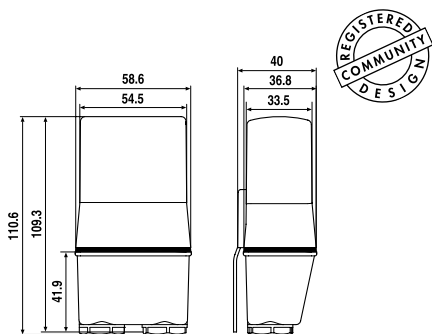

Type 10.41

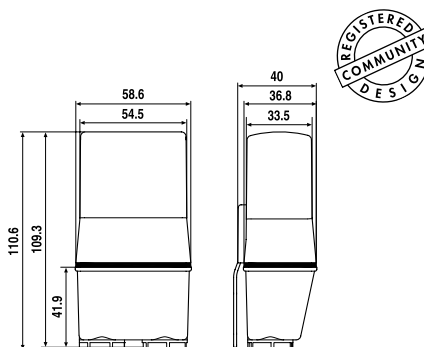

Type 10.42

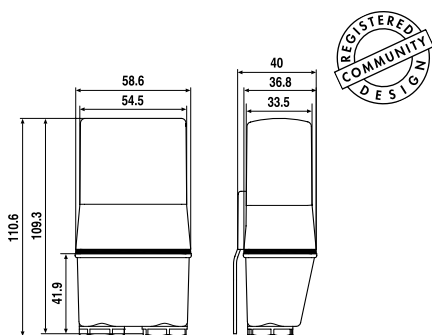

Type 10.51

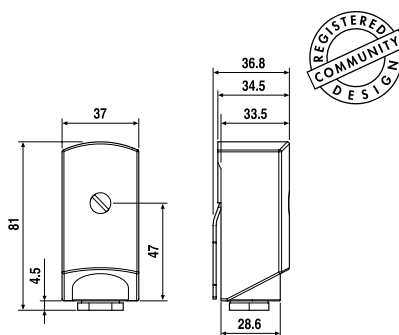

Type 10.61

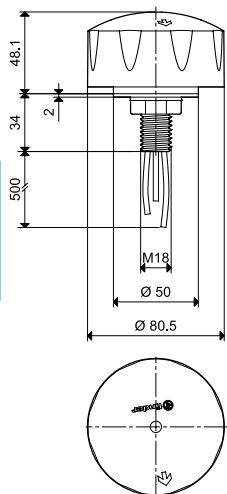



finder[®]
SWITCH TO THE FUTURE

Light dependent relays 12 - 16 A



Garden and
night lighting



Shop displays



Lighting for
parks



Streetlights and
car park lighting



11
SERIES

Relays for automatic control of lighting according to ambient light level - with separate light sensor

11.31 - 1 NO 16 A output contact

- Sensitivity adjustment from 1 to 100 lux
- One module, 17.5 mm wide
- Low energy consumption
- 24 V DC/AC supply version available

11.41 - 1 CO 16 A output contact

- European patent "zero hysteresis" for energy saving
- Italian patent "Light feedback compensation" principle
- Selector with 4 positions:
 - Standard range (threshold setting 1...80 lx)
 - High range (threshold setting 30...1000 lx)
 - continuous light (helpful during installation and initial testing and for maintenance purposes)
 - light off (useful for vacations)
- For the first 3 working cycles the delay time (On and Off) is reduced to zero in order to aid installation
- LED status indication
- SELV separation between contact and supply circuit
- Double insulation between supply and light sensor
- 35 mm rail (EN 60715) mount
- Cadmium free contact material
- Cadmium free light sensor (IC photo diode)

11.31



- 1 pole
- 17.5 mm wide

11.41



- 1 pole
- "zero hysteresis"
- 4 position selector

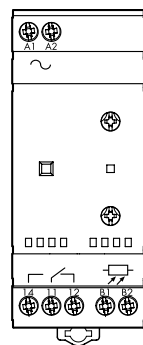

For outline drawing see page 10

Contact specification

Contact configuration		1 NO (SPST-NO)	1 CO (SPDT)
Rated current/Maximum peak current	A	16/30 (120 A - 5 ms)	16/30 (120 A - 5 ms)
Rated voltage/Maximum switching voltage	V AC	250/400	250/400
Rated load AC1	VA	4000	4000
Rated load AC15 (230 V AC)	VA	750	750
Nominal lamp rating:			
230 V incandescent/halogen W		2000	2000
fluorescent tubes with electronic ballast W		1000	1000
fluorescent tubes with electromechanical ballast W		750	750
CFL W		400	400
230 V LED W		400	400
LV halogen or LED with electronic ballast W		400	400
LV halogen or LED with electromechanical ballast W		800	800
Minimum switching load	mW (V/mA)	1000 (10/10)	1000 (10/10)
Standard contact material		AgSnO ₂	AgSnO ₂

Supply specification

Nominal voltage (U _N)	V AC (50/60 Hz)	12...24	110...230	230
	DC	12...24	—	—
Rated power	VA (50 Hz)/W	2.5/0.9		5.2/2
Operating range	V AC (50 Hz)	10.2...28.8	90...265	(0.8...1.1)U _N
	DC	10.2...32	—	—

Technical data

Electrical life at rated load in AC1	cycles	100 · 10 ³	100 · 10 ³
Threshold setting:	Standard range lx	1...100	1...80
	High range lx	—	30...1000
Hysteresis (switching Off/On ratio)		1.25	1
Delay time: switching On/Off	s	15/30	15/30
Ambient temperature range	°C	-20...+50	-20...+50
Protection category: light dependent relay/light sensor		IP 20/IP 54	IP 20/IP 54

Approvals (according to type)



Relays for automatic control of lighting according to ambient light level - with separate light sensor
11.42 - 1 CO + 1 NO 12 A output contacts

- Two independent outputs with individual lux setting
- Selector with 4 positions:
 - Standard range (threshold setting 1...80 lx)
 - High range (threshold setting 20...1000 lx)
 - continuous light (helpful during installation and initial testing and for maintenance purposes)
 - light off (useful for vacations)
- For the first 6 working cycles (in total for channels 1 & 2) the delay time (On and Off) is reduced to zero in order to aid installation
- LED status indication

11.91 - 1 CO 16 A output contact (+ auxiliary output for Power Module)

- Daily time switch function - programmable to inhibit main output (for energy saving)
- Auxiliary output - directly driven by the photosensor
- Italian patent "Light feedback compensation" principle
- Sensitivity adjustment from 1 to 150 lux
- LCD status indication, set-up and programming
- Internal battery for set-up/programming without supply and for time/program back-up in case of power failure (5 years)
- Low stand-by power consumption
- SELV separation between contact and supply circuit
- Double insulation between supply and light sensor
- 35 mm rail (EN 60715) mount
- Cadmium free contact material
- Cadmium free light sensor (IC photo diode)

For outline drawing see page 10

Contact specification

Contact configuration	1 CO (SPDT) + 1 NO (SPST-NO)	1 CO (SPDT) + 1 aux output*
Rated current/Maximum peak current	A 12/24 (120 A - 5 ms)	16/30 (120 A - 5 ms)
Rated voltage/Maximum switching voltage	V AC 250/400	250/400
Rated load AC1	VA 3000	4000
Rated load AC15 (230 V AC)	VA 750	750
Nominal lamp rating:		
230 V incandescent/halogen W	2000	2000
fluorescent tubes with electronic ballast W	1000	1000
fluorescent tubes with electromechanical ballast W	750	750
CFL W	400	400
230 V LED W	400	400
LV halogen or LED with electronic ballast W	400	400
LV halogen or LED with electromechanical ballast W	800	800
Minimum switching load	mW (V/mA) 1000 (10/10)	1000 (10/10)
Standard contact material	AgSnO ₂	AgSnO ₂

Supply specification

Nominal voltage (U _N)	V AC (50/60 Hz)	230	110...230
	DC	—	110...230
Rated power	VA (50 Hz)/W	7.4/2.8	5/2.1
Operating range	V AC (50 Hz)	(0.8...1.1)U _N	(0.8...1.1)U _N
	DC	—	(0.8...1.1)U _N

Technical data

Electrical life at rated load in AC1	cycles	100 · 10 ³	100 · 10 ³
Threshold setting:	Standard range lx	1...80	1...150
	High range lx	20...1000	—
Hysteresis (switching Off/On ratio)		1.25	Δ = 3 lx
Delay time: switching On / Off	s	15/30	25/50
Ambient temperature range	°C	-20...+50	-20...+50
Protection category: light dependent relay/light sensor		IP 20/IP 54	IP 20/IP 54

Approvals (according to type)

11.42

- 2 independent outputs
- 2 individual lux settings
- 4 position selector

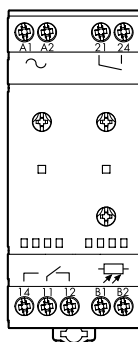
11.91

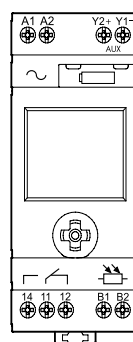

- Light dependent relay + time switch
- Auxiliary output (light dependent) with 19.91 power module available



* 11.91 auxiliary output:
12 V DC, 1 W max

Ordering information

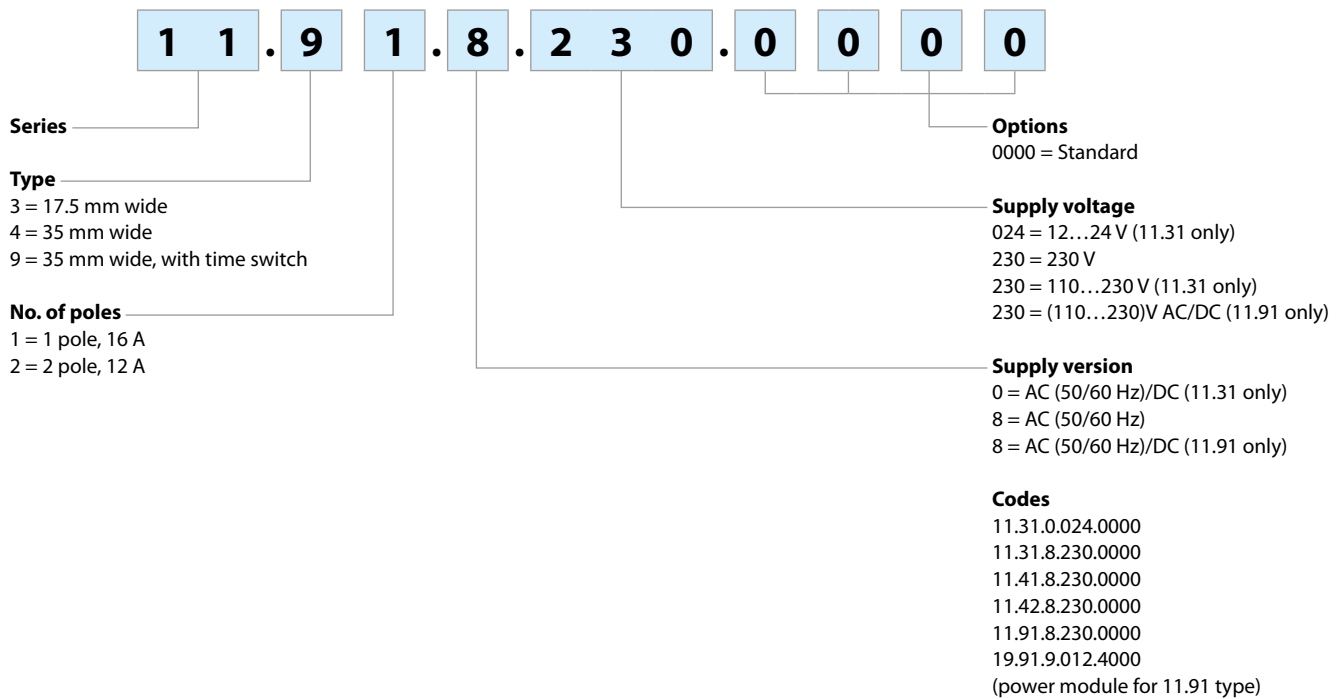
Example: 11 series light dependent relay with time switch, 1 CO (SPDT) 16 A contact, 230 V AC supply.



Technical data

Insulation		Dielectric strength	Impulse (1.2/50 µs)		
	between supply and contacts	4000 V AC	6 kV		
	between supply and light sensor	2000 V AC	4 kV		
	between open contacts	1000 V AC	1.5 kV		
EMC specifications					
Type of test		Reference standard	11.31	11.41 / 42 / 91	
Electrostatic discharge	contact discharge	EN 61000-4-2		4 kV	
	air discharge	EN 61000-4-2		8 kV	
Radiated electromagnetic field (80...1000 MHz)		EN 61000-4-3		10 V/m	
Fast transients (burst 5/50 ns, 5 and 100 kHz)	on supply terminals	EN 61000-4-4	3 kV	4 kV	
	on light sensor connection	EN 61000-4-4	3 kV	4 kV	
Voltage pulses on supply terminals (surge 1.2/50 µs)	common mode	EN 61000-4-5		4 kV	
	differential mode	EN 61000-4-5	3 kV	4 kV	
Radiofrequency common mode voltage (0.15...80 MHz)	on supply terminals	EN 61000-4-6		10 V	
	on light sensor	EN 61000-4-6		3 V	
Voltage dips	70% U _N , 40% U _N	EN 61000-4-11		10 cycles	
Short interruptions		EN 61000-4-11		10 cycles	
Radio frequency conducted emissions	0.15...30 MHz	EN 55014		class B	
Radiated emissions	30...1000 MHz	EN 55014		class B	
Terminals					
Screw torque		Nm	0.8		
Max. wire size	solid cable	1 x 6 / 2 x 4 mm ²	1 x 10 / 2 x 12 AWG		
	stranded cable	1 x 4 / 2 x 2.5 mm ²	1 x 12 / 2 x 14 AWG		
Wire strip length	mm	9			
Other data					
Cable grip of light sensor	mm	7.5...9			
Maximum cable length relay to light sensor	m	50 (2 x 1.5 mm ²)			
Preset threshold	lx	10			
Power lost to the environment		11.31	11.41	11.42	11.91
	in stand-by W	0.3	1.3	1.4	0.5
	without contact current W	0.9	2.0	2.8	2.1
	with rated current W	1.7	2.6	3.8	2.7

Wiring diagrams

Type 11.31

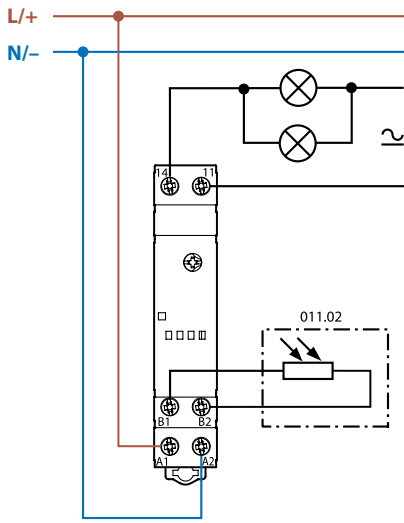

Type 11.42

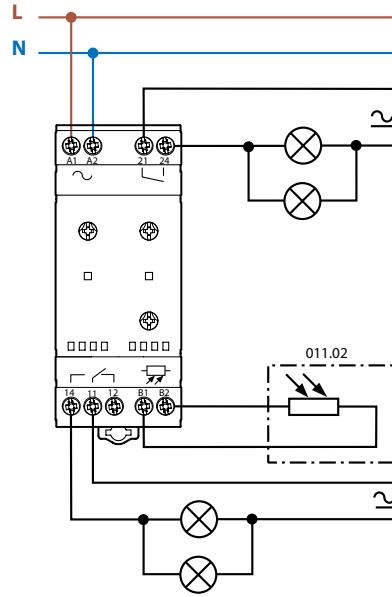

Type 11.41

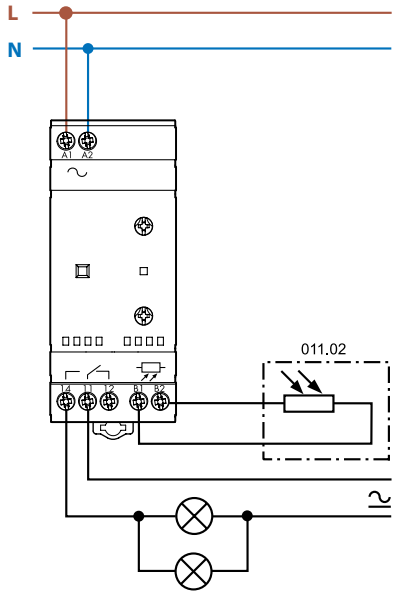

Type 11.91

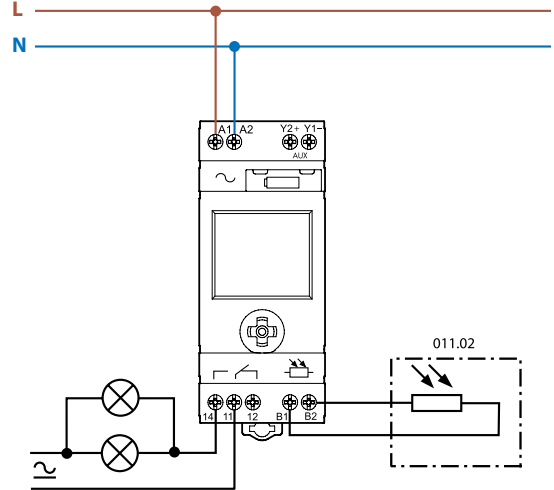

Type 11.91 + 19.91

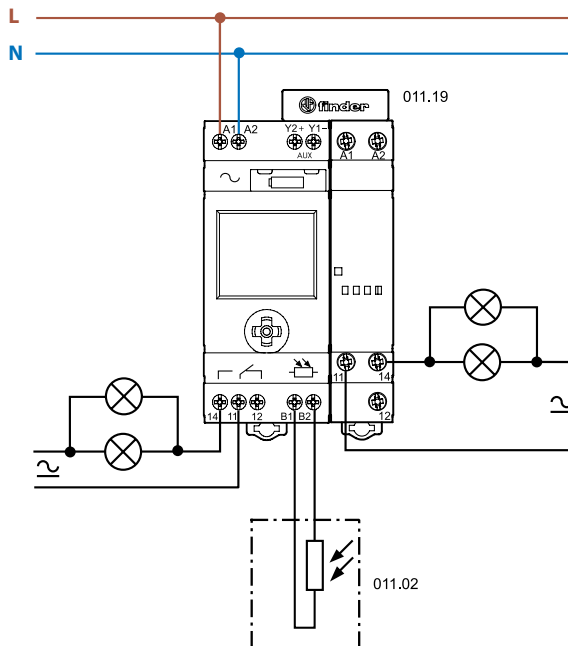

Advantage of the "zero hysteresis" patented circuit:

ensures reliable switching without wasting energy

TYPE 11.41 "ZERO HYSTERESIS"
LIGHT DEPENDENT RELAYS

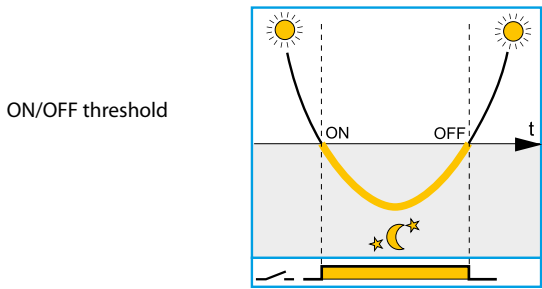

Switch OFF level = Switch ON level. Patented "zero hysteresis" circuitry ensures reliable switching without wasting energy.

TRADITIONAL
LIGHT DEPENDENT RELAYS

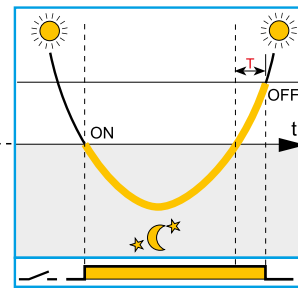

"Traditional" light dependent relays incorporate switching hysteresis to prevent malfunctioning or tripping. This results in an unnecessary delay in switching off, and a resulting waste of energy (over period T).

— Brightness of the natural light
— The NO of the light dependent relay is closed (light is switched on)

Advantage of the "light feedback compensation" principle:

avoids the effect of the lamps repeatedly "hunting" between On and Off, due to poor installation

Light dependent relay where the lighting being controlled does not influence the light level seen by the light sensor

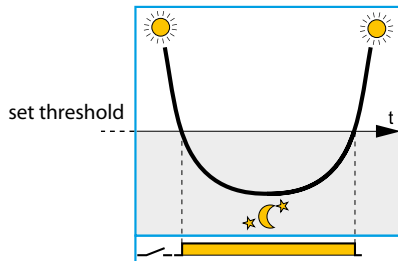

Correct functioning - provided the light sensor can be shielded from the effects of the controlled lighting switching On and Off

Traditional light dependent relay where the lighting being controlled influences the light level seen by the light sensor

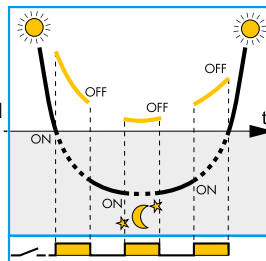

Incorrect functioning where the lamps cycle between On and Off, because their effect is being detected by the light sensor

Type 11.41 and 11.91 light dependent relay with "light feedback compensation"

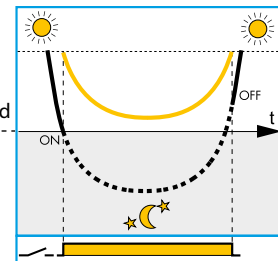







The innovative principle of "light feedback compensation" avoids the annoying and damaging effects of the lamps repeatedly "hunting" between On and Off, due to poor installation

— Ambient light level as measured by the light dependent relay's light sensor.
— Ambient light + controlled light level as measured by the light dependent relay's light sensor.

Notes

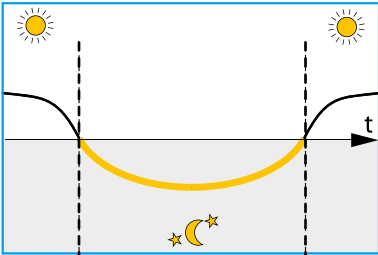
1. It is good practice to try to achieve a correct installation where the light emitted from the lamp(s) does not influence the light level seen by the light sensor, although the "light feedback compensation" principle will help when this is not fully achievable. In this case it should be appreciated that the "light feedback compensation" principle may delay slightly the time of Switch Off - beyond the ideal.
2. The compensation principle is not effective where the combined effect of the ambient light and the controlled lighting exceeds a maximum value (200 lux for the 11.91, 160/2000 lux for standard/high range of the 11.41).
3. The 11.41 and 11.91 types are compatible with gas discharge lamps that attain full output within 10 minutes, since the electronic circuit monitors lamps' light output over a 10 minute period to achieve a true assessment of its contribution to the overall lighting level.

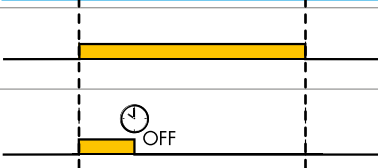
Functions 11.91

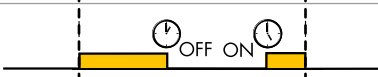
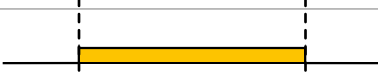
	Switch-OFF time	Switch-ON time	 	Application examples
	NO	NO		Working as a standard light-dependent relay
 11 14	YES 	NO		Working where lighting is not required from 10 PM onwards
	YES 	YES 		Working where lighting is not required between 1 AM and 5 AM
AUX Y1 Y2				Additional output - light dependent without time switch intervention

All the functions and the values can be set through the front joystick and are displayed on the front LCD.

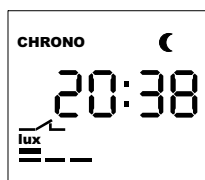
**Display mode**

During normal operation, with AC supply connected, the following is displayed:

- the current time
- the current lux level (upper bars)
- the set lux threshold (lower bars)
- the status (open/closed) of the 11-14 output contact
- the "moon" symbol (only if the current lux level is lower than the set threshold). It also indicates that the Auxiliary output is On, although the main output contact 11-14 may be On, depending on the chrono program.
- the "chrono" symbol (only if a switch-off time is enabled).

From **Display mode** it is possible to enter **Program mode** or **Set-up mode** with a short or long (> 2 s) press respectively, to the joystick centre. From **Display mode** it is also possible to enter **Hand mode**, where (independently of the lux level and the Chrono program) the 11-14 output contact is forced into the On or Off position with a long (> 2 s) press of the joystick upper or lower quadrants, respectively. The "hand" symbol is then displayed. A long press to the opposite quadrant will reset the hand mode.

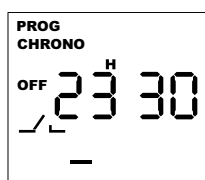
**Program mode**

In this mode it is possible to set the lux threshold level, to enable and to set the switch-off time, to enable and to set the switch-on time. With a short press to the joystick right or left quadrant it is possible to progress from one program step to another (accepting the values set). At any program step it is possible to modify the set values with a short press to the joystick upper or lower quadrant. A long (> 1 s) press allows the fast increment (or decrement) of values. A short press to the joystick centre will resume the display mode.

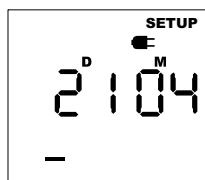
**Set-up mode**

In this mode it is possible to set the current year, month, day, hour and minute (in this order) and to enable european "Daylight saving".

With a short press to the joystick right or left quadrant it is possible to progress from one set-up step to another (accepting the values set); in any step it is possible to modify the set values with a short press to the joystick upper or lower quadrant. A long (> 1 s) press allows the fast increment (or decrement) of values.

A short press to the joystick centre will resume the display mode.

Note: the product is supplied with central european time factory set and "Daylight saving" enabled.

Power-off mode

If the 230 V AC supply is not connected, the relay enters power-off mode and to ensure the long life of the built-in back-up battery only the clock is maintained active. The display turns off and no other operation (including light measurement) is performed.

With a press to the joystick during power-off mode it is possible to "awaken" the device and to enter program or set-up mode (the "electrical plug" symbol is displayed); after about 1 minute inactivity the power-off mode is resumed.

Note: with the supply not connected, the program or set-up modes absorb a higher current than the power-off mode, thus influencing the battery life.

Auxiliary output

A solid state output at terminals Y1-Y2 is provided (rated 12 V DC, 80 mA/1 W max.): this can be used with the power module **19.91.9.012.4000** connected by the dedicated **011.19** connector. Or, it is possible to connect a suitable relay (for example, 38-48-49-4C-58-59 interface module) provided the coil is within the rating, and the wiring does not exceed 40 cm length. The auxiliary output is driven exclusively by the light sensor of the device, and is consequently independent of the time switch. With the main contact, this permits a flexible lighting system controlled by the ambient light, both with and without the influence of the time switch function.



19.91 power module specification		
Contact configuration		1 CO (SPDT)
Rated current/Maximum peak current (I_N/I_{max})	A	16/30 (120 A – 5 ms)
Rated voltage/Maximum switching voltage (U_N/U_{max})	V AC	250/400
Rated load AC15 (230 V AC)	VA	750
Nominal lamp rating:		
	230 V incandescent/halogen W	2000
	fluorescent tubes with electronic ballast W	1000
	fluorescent tubes with electromechanical ballast W	750
	CFL W	400
	230 V LED W	400
	LV halogen or LED with electronic ballast W	400
	LV halogen or LED with electromechanical ballast W	800
Nominal supply voltage (U_N)	V DC	12
Ambient temperature range	°C	-20...+50
Protection category		IP 20

11.31/41/42

LED	Supply voltage	NO output contact	
		11.41/11.42	11.31
	OFF	Open	Open
	ON	Open	Open
	ON	Open (timing to close in progress)	Open (timing to close in progress)
	ON	Closed	Closed
	ON	Closed (timing to open in progress)	Closed (timing to open in progress)
	ON	Fixed position (On or Off on selector)	—

Outline drawings

11.31
Screw terminal

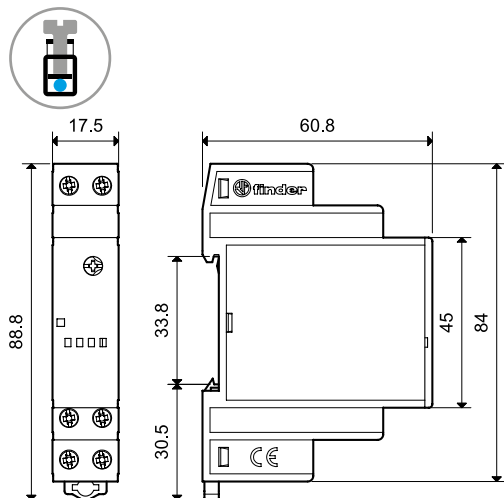

11.42
Screw terminal

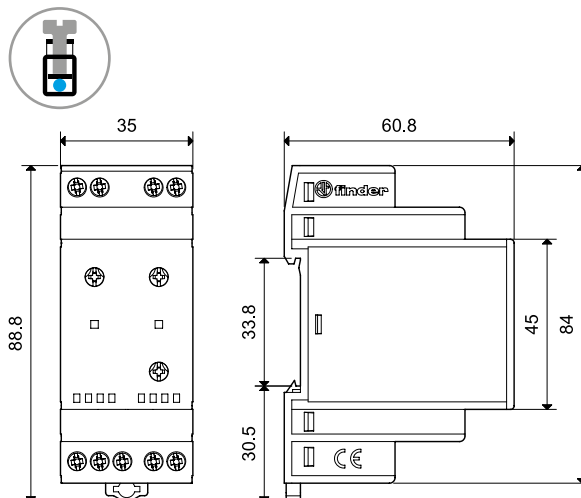

11.41
Screw terminal

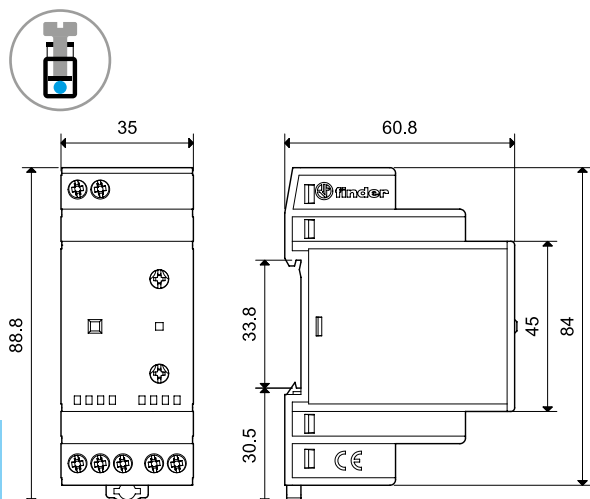

11.91
Screw terminal

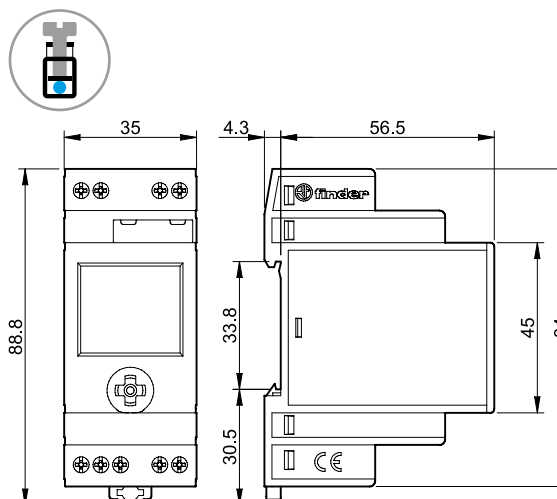

19.91 (power module for 11.91)
Screw terminal

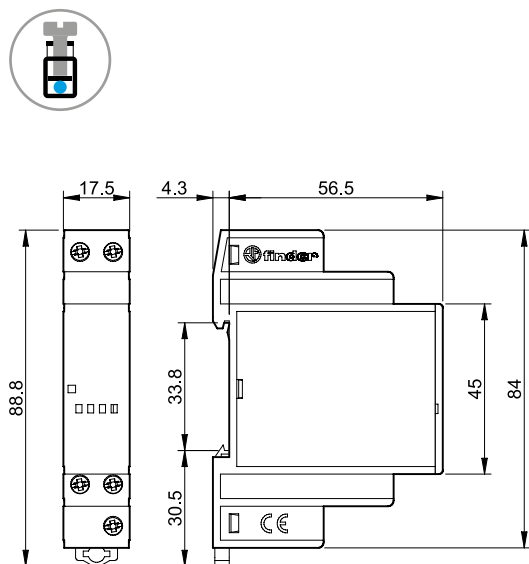

11.91 + 19.91 power module
Screw terminal

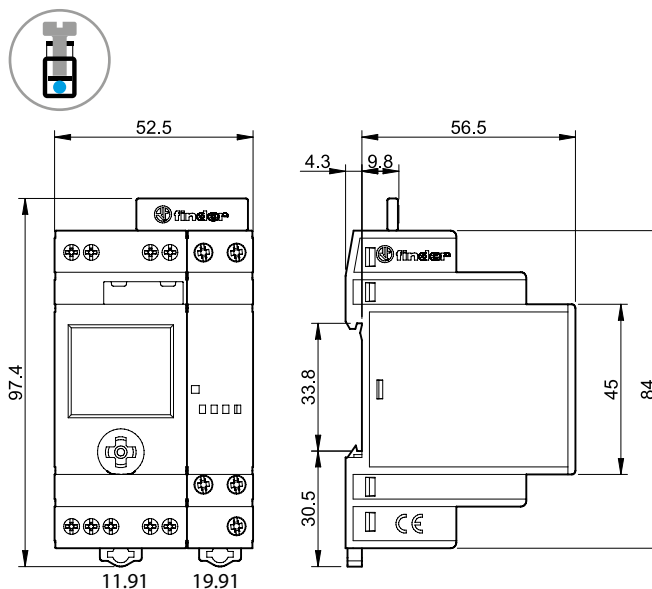

Accessories



011.02

Light sensor (supplied with light dependent relay) 011.02

- Ambient temperature range: -40...+70 °C
- Cadmium free
- Non polarized
- Double insulated with respect to light dependent relay supply
- Not compatible with old 11.01 and 11.71 light dependent relay (to be used with 011.00 photosensor)

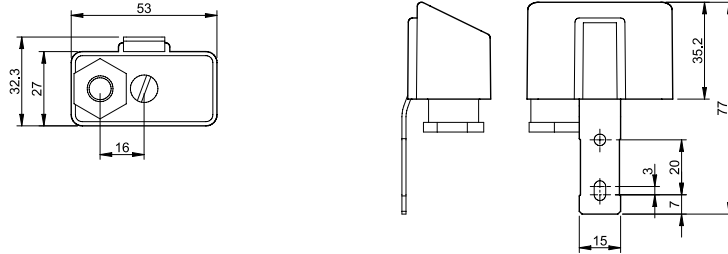

011.03

Flush-mounted light sensor (protection category: IP66/67) 011.03

- Ambient temperature range: -40...+70 °C
- Cadmium free
- Non polarized
- Double insulated with respect to light dependent relay supply
- Not compatible with old 11.01 and 11.71 light dependent relay
- Supplied with light dependent relay (packaging code POA)

Connection cable

Material	PVC, flame retardant
Conductor size	mm ² 0.5
Cable length	mm 500
Cable diameter	mm 5.0
Working voltage	V 300/500
Test voltage, cable	kV 2.5
Max. temperature	°C +90

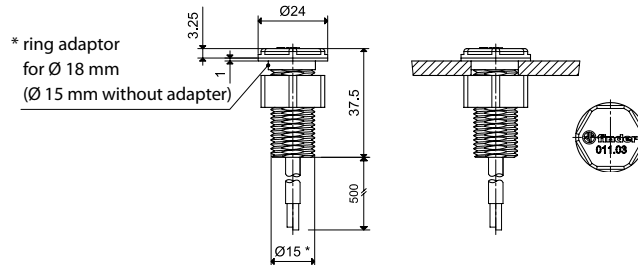

011.01

Adaptor for panel mounting (supplied with light dependent relay), 35 mm wide 011.01

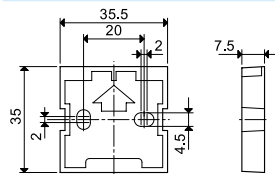

011.19

2-pole connector (for type 11.91 and 19.91 power module) 011.19

For direct connection of 11.91 auxiliary output (Y1-Y2) to 19.91 supply (A1-A2)

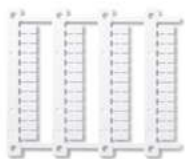
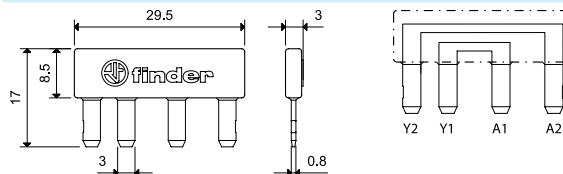

060.48

Sheet of marker tags, for types 11.31, 11.41, 11.42, 19.91, plastic, 48 tags, 6 x 12 mm, for CEMBRE thermal transfer printers 060.48



019.01

Identification tag, for types 11.41 and 11.42, plastic, 1 tag, 17 x 25.5 mm 019.01



finder[®]
SWITCH TO THE FUTURE

Time switches 16 A



Heating and cooling



Shop displays



Lighting for parks



Streetlights and car park lighting



School bells



12
SERIES

Mechanical time switches

- **Daily time setting***
- **Weekly time setting****

Type 12.01

- Daily
- 1 CO 16 A
- 35.8 mm wide
- 35 mm rail mount

Type 12.11

- Daily
- 1 NO 16 A
- 17.5 mm wide
- 35 mm rail mount

Type 12.31-0000

- Daily
- 1 CO 16 A
- 72 x 72 mm
- Front panel mount

Type 12.31-0007

- Weekly
- 1 CO 16 A
- 72 x 72 mm
- Front panel mount

- Minimum time interval setting:
1 h (12.31-0007)
30 min (12.01)
15 min (12.11 - 12.31-0000)

* Same program every day

** Different program possible for each of the 7 days of the week

For outline drawing see page 13

12.01



- Mechanical daily time switch
- 1 CO 16 A
- 35 mm rail (EN 60715) mount

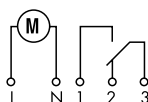

12.11



- Mechanical daily time switch
- 1 NO 16 A
- 35 mm rail (EN 60715) mount

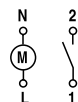

12.31



- Mechanical daily or weekly
- 1 CO 16 A
- Front panel mounting

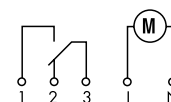

Contact specification

Contact configuration	1 CO (SPDT)	1 NO (SPST-NO)	1 CO (SPDT)
Rated current/Maximum peak current	A 16/—	16/30	16/—
Rated voltage/Maximum switching voltage	V AC 250/—	250/—	250/—
Rated load AC1	VA 4000	4000	4000
Rated load AC15 (230 V AC)	VA 750	420	420
Nominal lamp rating:			
incandescent (230 V) W	2000 (NO contact)	2000	2000
compensated fluorescent (230 V) W	750 (NO contact)	750	750
uncompensated fluorescent (230 V) W	1000 (NO contact)	1000	1000
halogen (230 V) W	2000 (NO contact)	2000	2000
Minimum switching load	mW (V/mA) 1000 (10/10)	1000 (10/10)	1000 (10/10)
Standard contact material	AgSnO ₂	AgSnO ₂	AgCdO

Supply specification

Nominal voltage (U _N)	V AC (50/60 Hz)	230	230	120 - 230
	V DC	—	—	—
Rated power AC/DC	VA (50 Hz)/W	2/—	2/—	2/—
Operating range	AC (50 Hz)	(0.85...1.1)U _N	(0.85...1.1)U _N	(0.85...1.1)U _N
	DC	—	—	—

Technical data

Electrical life at rated load in AC1	cycles	50 · 10 ³	50 · 10 ³	50 · 10 ³
Type of time switch		daily	daily	daily weekly
Switching intervals /day		48	96	96 24 (168/week)
Minimum switching interval	min	30	15	15 60
Accuracy	s/day	1.5	1.5	1.5
Ambient temperature range	°C	-5...+50	-5...+50	-10...+50
Protection category		IP 20	IP 20	IP 20

Approvals (according to type)



Type 12.51

Digital (analogue-style) time switch, daily/weekly programming

- Can be programmed in "Classic" mode via the joystick, or "Smart" mode via smartphones with NFC communication
- Minimum time interval setting - 30 minutes
- Easily configurable for daily or weekly programming

Type 12.81

Digital Astro-switch

- Can be programmed in "Classic" mode via the joystick, or "Smart" mode via smartphones with NFC communication
- Astro program: calculation of sunrise and sunset times through date, time and location coordinates
- Option for Astro ON period override, by timeswitch
- Location coordinates easily settable for most European countries through post codes
- Offset function: allows programming of switching times offset from the astronomical time (by up to 90 min, in 10 min steps)
- Summer/Winter European, Australian, Brazilian time
- 1 CO 16 A output contact
- LCD status indication, set-up and programming
- Lock with a 4-digit PIN
- Back-light display
- Internal battery for set-up and programming without supply, easily replaceable from the front
- Protective separation between supply and contacts
- 35 mm wide
- 35 mm rail (EN 60715) mount
- Cadmium free contact material

For outline drawing see page 13

NEW 12.51



- Digital time switch
- 1 CO 16 A

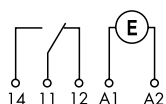

NEW 12.81

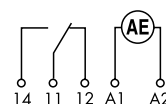

- Digital Astro-switch
- 1 CO 16 A

**Contact specification**

Contact configuration		1 CO (SPDT)	1 CO (SPDT)
Rated current/Maximum peak current	A	16/30 (120 A - 5 ms)	16/30 (120 A - 5 ms)
Rated voltage/ Maximum switching voltage	V AC	250/400	250/400
Rated load AC1	VA	4000	4000
Rated load AC15 (230 V AC)	VA	750	750
Nominal lamp rating:			
230 V incandescent/halogen W		2000	2000
fluorescent tubes with electronic ballast W		1000	1000
fluorescent tubes with electromechanical ballast W		750	750
CFL W		400	400
230 V LED W		400	400
LV halogen or LED with electronic ballast W		400	400
LV halogen or LED with electromechanical ballast W		800	800
Minimum switching load	mW (V/mA)	1000 (10/10)	1000 (10/10)
Standard contact material		AgSnO ₂	AgSnO ₂

Supply specification

Nominal voltage (U _N)	V AC (50/60 Hz)	110...230	110...230
	V DC	110...230	110...230
Rated power AC/DC	VA (50 Hz)/W	2.8/0.9	2.8/0.9
Operating range	V AC (50 Hz)	88...264	88...264
	V DC	88...264	88...264

Technical data

Electrical life at rated load in AC1	cycles	100 · 10 ³	100 · 10 ³
Switching intervals		48	—
Minimum switching interval	min	30	—
Accuracy	s/day	1	1
Ambient temperature range	°C	-20...+50 (see page 9, diagram L12)	-20...+50 (see page 9, diagram L12)
Protection category		IP 20	IP 20

Approvals (according to type)

CE EAC

Digital time switch, weekly programming
- Can be programmed in "Classic" mode via the joystick, or "Smart" mode via smartphones with NFC communication

Type 12.61

- 1 CO 16 A

Type 12.62

- 2 CO 16 A

• Functions:

Switch ON, Switch OFF

Pulse: 1s...59 min

- Minimum time interval setting - 1 minute
- Summer/Winter European, Australian, Brazilian time
- LCD status indication, set-up and programming
- Lock with a 4-digit PIN
- Back-light display
- Internal battery for set-up and programming without supply, easily replaceable from the front
- Protective separation between supply and contacts
- 35 mm wide
- 35 mm rail (EN 60715) mount
- Cadmium free contact material



- Weekly programming
- 1 CO 16 A
- Switch ON, Switch OFF, Pulse



- Weekly programming
- 2 CO 16 A
- Switch ON, Switch OFF, Pulse

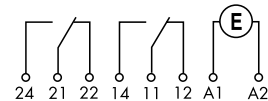
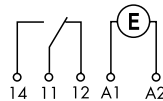

For outline drawing see page 14

Contact specification

Contact configuration		1 CO (SPDT)	2 CO (DPDT)
Rated current/Maximum peak current	A	16/30 (120 A - 5 ms)	16/30 (120 A - 5 ms)
Rated voltage/Maximum switching voltage	V AC	250/400	250/400
Rated load AC1	VA	4000	4000
Rated load AC15 (230 V AC)	VA	750	750
Nominal lamp rating:			
230 V incandescent/halogen W		2000	2000
fluorescent tubes with electronic ballast W		1000	1000
fluorescent tubes with electromechanical ballast W		750	750
CFL W		400	400
230 V LED W		400	400
LV halogen or LED with electronic ballast W		400	400
LV halogen or LED with electromechanical ballast W		800	800
Minimum switching load	mW (V/mA)	1000 (10/10)	1000 (10/10)
Standard contact material		AgSnO ₂	AgSnO ₂

Supply specification

Nominal voltage (U _N)	V AC (50/60 Hz)	12...24	110...230	110...230
	V DC	12...24	110...230	110...230
Rated power AC/DC	VA (50 Hz)/W	2.8/0.9		2.8/0.9
Operating range	V AC (50 Hz)	10...30	88...253	88...253
	V DC	10...30	88...253	88...253

Technical data

Electrical life at rated load in AC1	cycles	100 · 10 ³	100 · 10 ³
Type of time switch		Weekly	Weekly
Memory locations for switching times		50	50
Minimum internal setting	min	1	1
Accuracy	s/day	1	1
Ambient temperature range	°C	-20...+50 (see page 9, diagram L12)	-20...+50 (see page 9, diagram L12)
Protection category		IP 20	IP 20

Approvals (according to type)



Weekly Astro time switch

- Can be programmed in "Classic" mode via the joystick, or "Smart" mode via smartphones with NFC communication
- "Astro" program: calculation of sunrise and sunset times through date, time and location coordinates

Type 12.A1

- 1 CO 16 A

Type 12.A2

- 2 CO 16 A

• Functions:

- "Astro" ON, "Astro" OFF
- Switch ON, Switch OFF
- Pulse: 1s...59 min
- Location coordinates easily settable for most European countries through Post codes
- Offset function: allows programming of switching times offset from the astronomic time (by up to 90 min, in 1 min step)
- Minimum time interval setting - 1 minute
- Summer/Winter European, Australian, Brazilian time
- LCD status indication, set-up and programming
- Lock with a 4-digit PIN
- Back-light display
- Internal battery for set-up and programming without supply, easily replaceable from the front
- Protective separation between supply and contacts
- 35 mm wide
- 35 mm rail (EN 60715) mount
- Cadmium free contact material

For outline drawing see page 14

NEW 12.A1

- Weekly programming
- 1 CO 16 A
- Switch ON, Switch OFF, Pulse

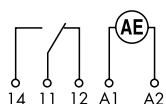
**NEW 12.A2**

- Weekly programming
- 2 CO 16 A
- Switch ON, Switch OFF, Pulse

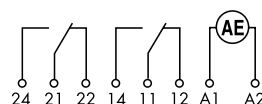
**Contact specification**

Contact configuration		1 CO (SPDT)	2 CO (DPDT)
Rated current/Maximum peak current	A	16/30 (120 A - 5 ms)	16/30 (120 A - 5 ms)
Rated voltage/ Maximum switching voltage	V AC	250/400	250/400
Rated load AC1	VA	4000	4000
Rated load AC15 (230 V AC)	VA	750	750
Nominal lamp rating:			
230 V incandescent/halogen W		2000	2000
fluorescent tubes with electronic ballast W		1000	1000
fluorescent tubes with electromechanical ballast W		750	750
CFL W		400	400
230 V LED W		400	400
LV halogen or LED with electronic ballast W		400	400
LV halogen or LED with electromechanical ballast W		800	800
Minimum switching load	mW (V/mA)	1000 (10/10)	1000 (10/10)
Standard contact material		AgSnO ₂	AgSnO ₂

Supply specification

Nominal voltage (U _N)	V AC (50/60 Hz)	110...230	12...24	110...230
	V DC	110...230	12...24	110...230
Rated power AC/DC	VA (50 Hz)/W	2.8/0.9	2.8/0.9	
Operating range	V AC (50 Hz)	88...253	10...30	88...253
	V DC	88...253	10...30	88...253

Technical data

Electrical life at rated load in AC1	cycles	100 · 10 ³	100 · 10 ³	
Type of time switch		Weekly	Weekly	
Memory locations for switching times		50	50	
Minimum internal setting	min	1	1	
Accuracy	s/day	1	1	
Ambient temperature range	°C	-20...+50 (see page 9, diagram L12)	-20...+50 (see page 9, diagram L12)	
Protection category		IP 20	IP 20	

Approvals (according to type)

Electronic digital time switches
- 1 Weekly time setting

Type 12.71

- 1 CO 16 A
- 17.8 mm wide
- Minimum time interval setting - 1 minute
- Internal battery for set-up without supply
- Pulse output function:
1 s... 59:59(mm:ss)
- Automatic adjustment for daylight saving
- 35 mm rail (EN 60715) mount

12.71



- Digital weekly time switch
- 1 CO 16 A
- 17.8 mm wide

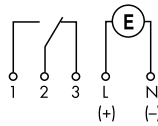

For outline drawing see page 13

Contact specification

Contact configuration	1 CO (SPDT)	
Rated current/Maximum peak current	A	16/30
Rated voltage/ Maximum switching voltage	V AC	250/—
Rated load AC1	VA	4000
Rated load AC15 (230 V AC)	VA	420
Nominal lamp rating:		
230 V incandescent/halogen W	400	
fluorescent tubes with electronic ballast W	100	
fluorescent tubes with electromechanical ballast W	100	
CFL W	50	
230 V LED W	50	
LV halogen or LED with electronic ballast W	50	
LV halogen or LED with electromechanical ballast W	100	
Minimum switching load	mW (V/mA)	1000 (10/10)
Standard contact material	AgNi	

Supply specification

Nominal voltage (U _N)	V AC (50/60 Hz)	—	230
	V AC/DC	24	—
Rated power AC/DC	VA (50 Hz)/W	1.4/1.4	2/—
Operating range	AC (50 Hz)	(0.9...1.1)U _N	(0.85...1.1)U _N
	DC	(0.9...1.1)U _N	—

Technical data

Electrical life at rated load in AC1	cycles	50 · 10 ³
Type of time switch	weekly	
Memory locations for switching times*	30	
Minimum switching interval	min	1
Accuracy	s/day	0.5
Ambient temperature range	°C	-30...+55
Protection category	IP 20	

Approvals (according to type)



* Switching times in memory may be used more than once i.e. when selected for different days.

Ordering information

Example: 12 series digital (analogue style) time switch, 1 CO 16 A contact, (110...230)V AC/DC supply

1 2 . 5 1 . 8 . 2 3 0 . 0 0 0 0

Series**Type**

0 = Daily, 35.8 mm wide
 1 = Daily, 17.5 mm wide
 3 = Daily or Weekly, 72 x 72 mm
 5 = Digital (analogue style),
 NFC programming, 35 mm wide
 6 = Weekly, NFC programming,
 35 mm wide
 7 = Weekly, 17.5 mm wide
 8 = Astro-switch, NFC programming,
 35 mm wide
 A = Weekly "Astro", NFC programming,
 35 mm wide

No. of poles

1 = 1 CO (SPDT), 16 A
 1 = 1 NO (SPST), 16 A
 2 = 2 CO (DPDT), 16 A

Option

0 = With power back-up
 1 = Without power back-up
 (type 12.11)

Supply voltage

024 = 24 V AC/DC (type 12.71)
 024 = 12...24 V AC/DC
 (types 12.61, 12.A2)
 120 = 120 V AC
 230 = 230 V AC
 230 = (110...230)V AC/DC
 (types 12.51, 12.61, 12.62,
 12.81, 12.A1, 12.A2)

Supply version

0 = AC (50/60 Hz)/DC
 (types 12.61.0.024, 12.A2.0.024, 12.71.0.024)
 8 = AC (50/60 Hz)
 8 = AC (50/60 Hz)/DC
 (types 12.51, 12.81, 12.61, 12.62, 12.A1, 12.A2)

Option

0 = Standard
 0 = Daily only for 12.31
 7 = Weekly only for 12.31

Special version

0 = Standard

Codes

12.01.8.230.0000
 12.11.8.230.0000
 12.11.8.230.1000
 12.31.8.230.0000
 12.31.8.230.0007
 12.51.8.230.0000
 12.71.0.024.0000
 12.71.8.230.0000
 12.81.8.230.0000
 12.61.0.024.0000
 12.61.8.230.0000
 12.62.8.230.0000
 12.A1.8.230.0000
 12.A2.0.024.0000
 12.A2.8.230.0000

Technical data

Insulation		12.51, 12.61, 12.62, 12.81, 12.A1, 12.A2	12.01, 12.11, 12.31, 12.71	
Dielectric strength between supply and contacts	V AC	4000	4000	
Dielectric strength between open contacts	V AC	1000	1000	
Rated impulse voltage (between supply and contacts)	kV/(1.2/50) μ s	6	6	
Rated impulse voltage (between open contacts)	kV/(1.2/50) μ s	1.5	1.5	
EMC specifications				
Type of test		Reference standard		
Electrostatic discharge	contact discharge	EN 61000-4-2	4 kV	6 kV
	air discharge	EN 61000-4-2	8 kV	8 kV
Radiated electromagnetic field (80...1000 MHz)		EN 61000-4-3	10 V/m	10 V/m
Fast transients (burst 5/50 ns, 5 and 100 kHz)		EN 61000-4-4	4 kV	4 kV
Voltage pulses on supply terminals (surge 1.2/50 μ s)	common mode	EN 61000-4-5	4 kV	2 kV
	differential mode	EN 61000-4-5	4 kV	2 kV
Radiofrequency common mode voltage (0.15...80 MHz)		EN 61000-4-6	10 V	10 V
Voltage dips	70% U_N , 40% U_N	EN 61000-4-11	10 cycles	10 cycles
Short interruptions		EN 61000-4-11	10 cycles	10 cycles
Radio frequency conducted emissions	0.15...30 MHz	EN 55014	class B	class B
Radiated emissions		30...1000 MHz	EN 55014	class B
Terminals				
Screw torque		Nm	0.8	1.2
Max. wire size		mm ²	AWG	mm ²
	solid cable	1 x 6 / 2 x 4	1 x 10 / 2 x 12	1 x 6 / 2 x 4
	stranded cable	1 x 4 / 2 x 2.5	1 x 12 / 2 x 14	1 x 6 / 2 x 2.5
Wire strip length		mm	9	
Other data				
Power back-up (Battery life)		6 years (12.51, 12.61, 12.62, 12.81, 12.A1, 12.A2, 12.71)		
Battery type		CR 2032, 3 V, 230 mAh (12.51, 12.61, 12.62, 12.81, 12.A1, 12.A2)		
Power back-up		100 h (12.01, 12.11, 12.31 - following 80 h continuous energisation)		
Power lost to the environment		12.51, 12.61, 12.81, 12.A1	12.62, 12.A2	12.01, 12.11, 12.31
	in stand-by W	0.2	0.2	—
	without contact current W	0.9	0.9	1.5
	with rated current W	1.5	2.1	2.5
				12.71
				3 (for 1 pole)

L 12 - Rated current v ambient temperature

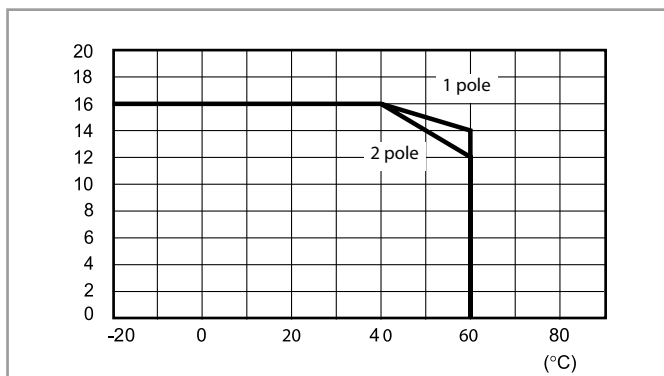

Wiring diagrams

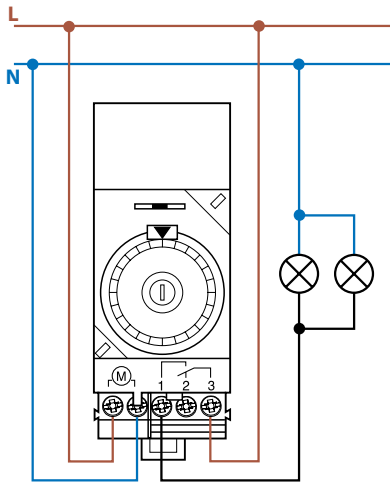

Type 12.01

Selector switch:

- ⊖ = Permanently OFF
- AUTO = Automatic
- I = Permanently ON

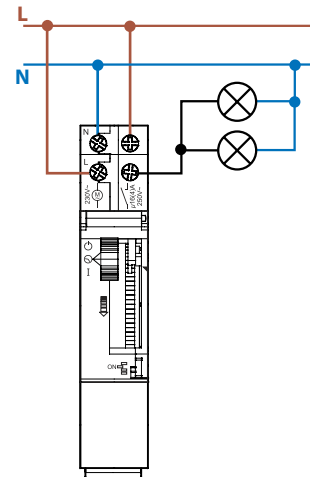

Type 12.11

Selector switch:

- ⊖ = Permanently OFF
- ⊖ = Automatic
- I = Permanently ON

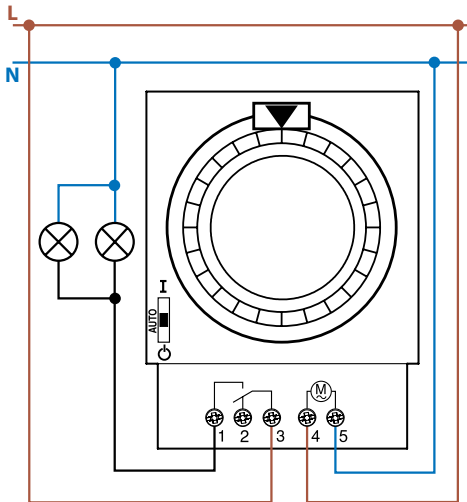

Type 12.31

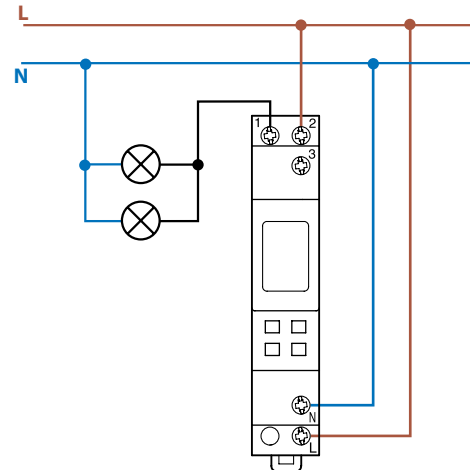

Type 12.71

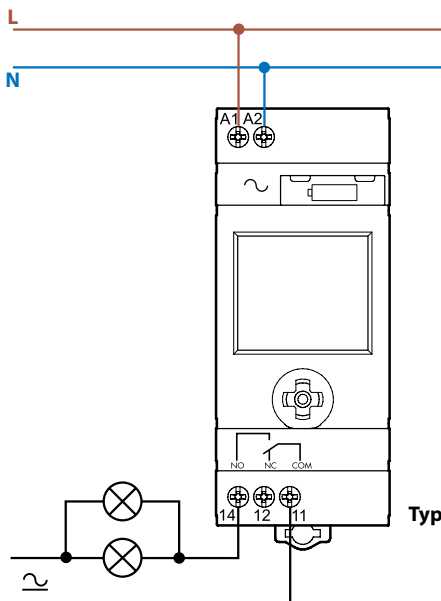

**Type 12.51
12.81**

Wiring diagrams

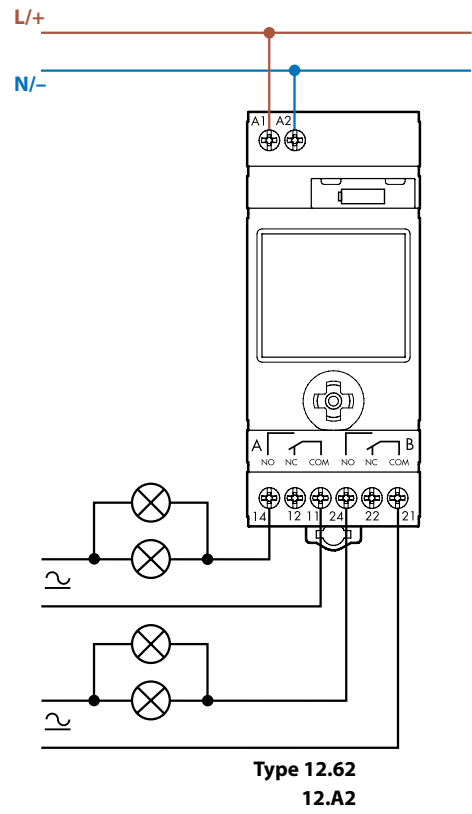
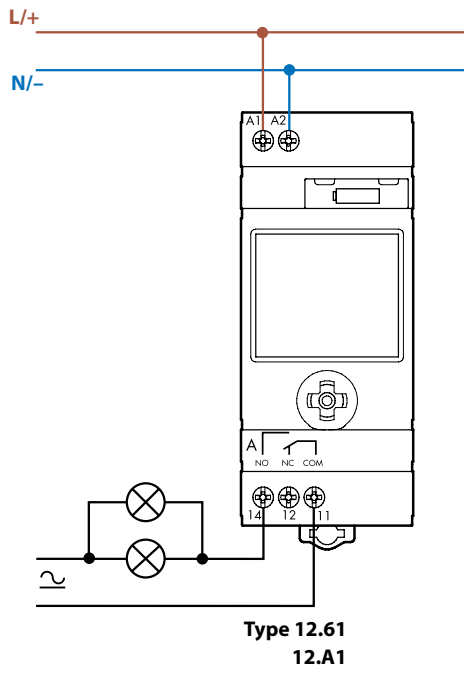

Two programming modes for type 12.51, 12.61, 12.62, 12.81, 12.A1, 12.A2

“Smart”

Mode via smartphones with NFC communication using Finder toolbox Android App.



“Classic”

Mode via the joystick

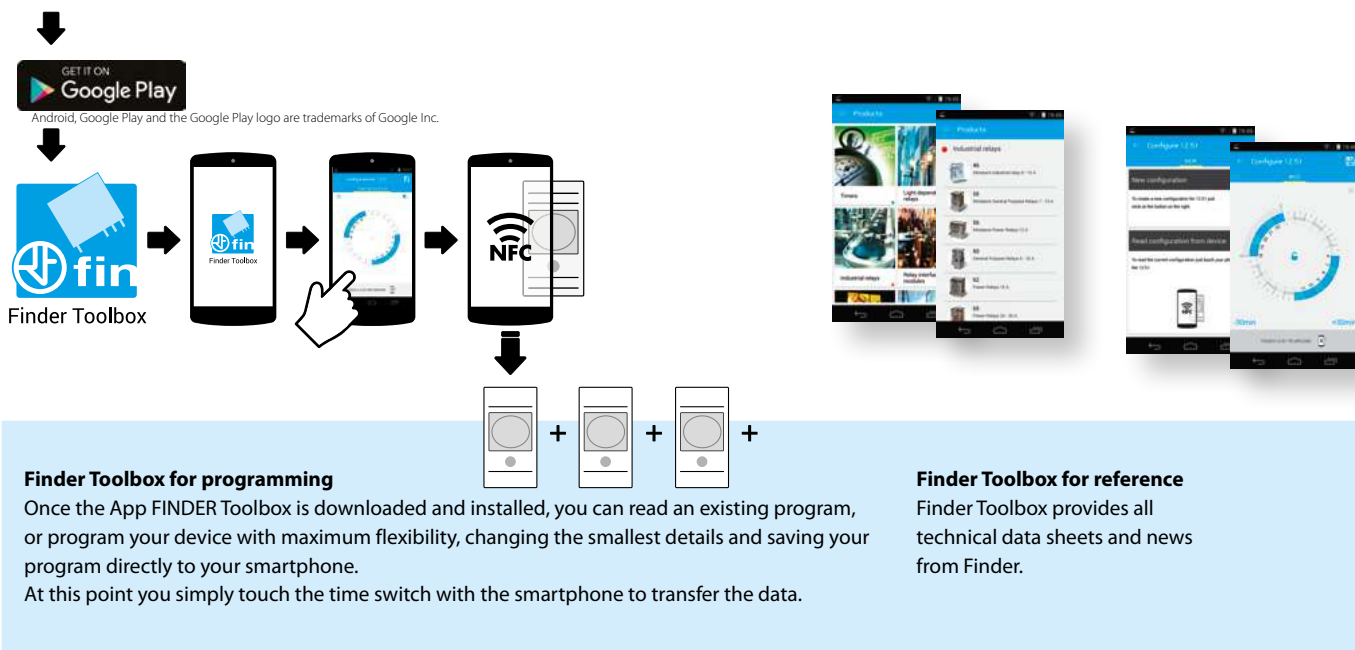

Functions type 12.81

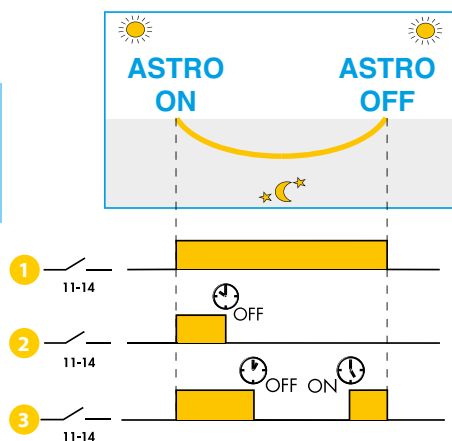

The Override feature permits the 12.81 three different ways of functioning:

- 1 Classic function where the **AstroON** and **AstroOFF** times are determined by the geographic coordinates. These times vary every day.
- 2 Functions such that the output turns on according to the **AstroON** time and turns off according to the clock off-time OFF . Application example: shop window lighting on by **AstroON** at sunset and off OFF at 00:30.
- 3 Functions such that the output turns on according to the **AstroON** time and turns off according to the clock off-time OFF , and then turns back on at the clock on-time ON (for the remainder of the ASTRO time period). Application example: company car park lighting, on by **AstroON** at sunset, off end of the evening shift at 23:00 OFF . On again at the beginning of the morning shift at 5:00 ON and off automatically by **AstroOFF***.

* Depending on the time of year (summer specifically) it may be that the override ON time will fall after the AstroOFF time. In this case, the output switches off at the AstroOFF time and the override ON time is ignored.

Outline drawings

12.01
Screw terminal

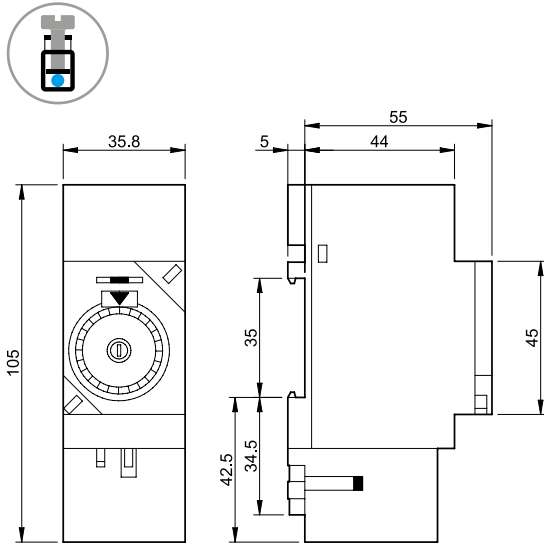

12.11
Screw terminal

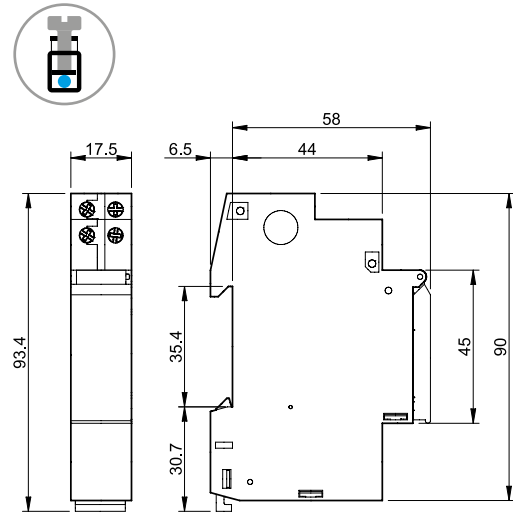

12.31
Screw terminal

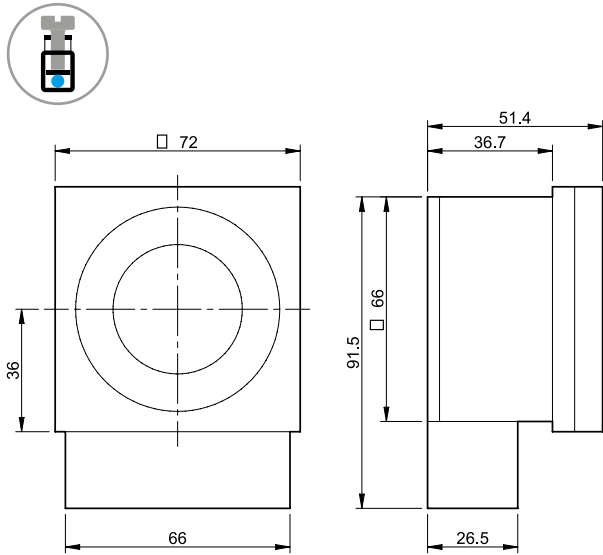

12.51/12.81
Screw terminal

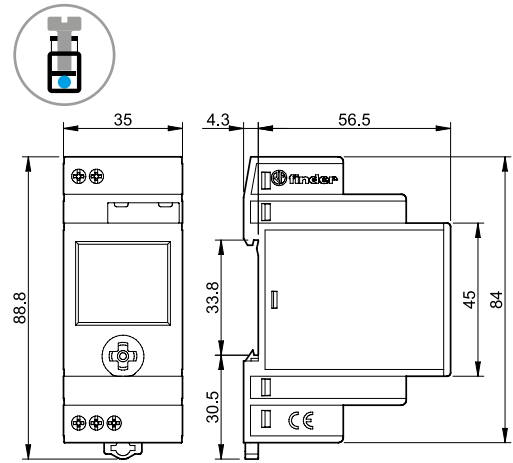

12.71
Screw terminal

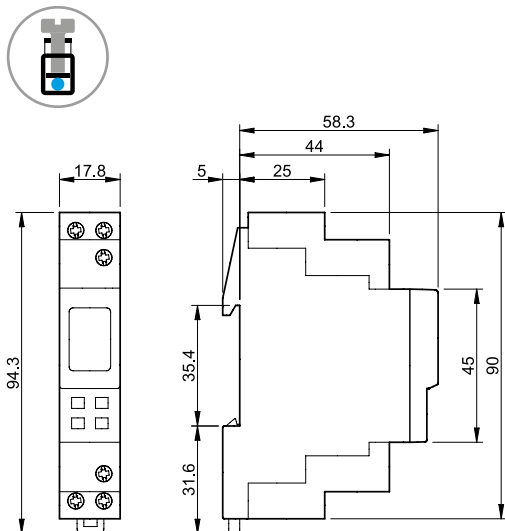

Outline drawings

12.61 / 12.A1
Screw terminal

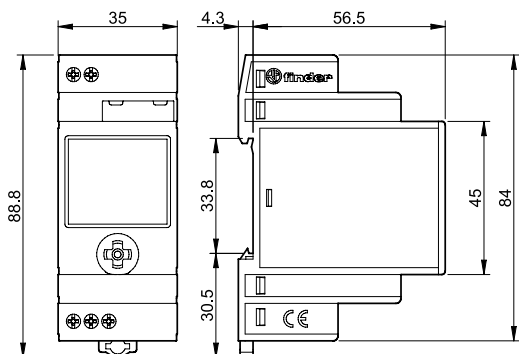

12.62 / 12.A2
Screw terminal

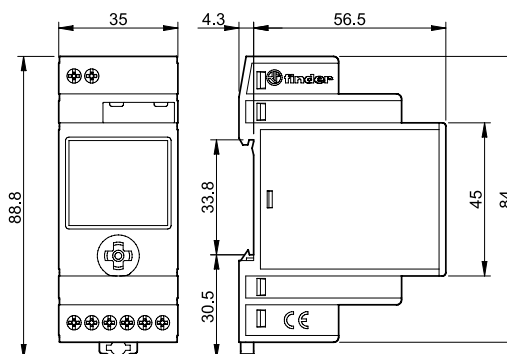

Battery replacement type 12.51, 12.61, 12.62, 12.81, 12.A1, 12.A2



Power-save mode

If the 230 V AC supply is not connected, the time switch enters power-save mode: only the clock is maintained active whilst the display turns off so as to guarantee a long life for the built-in back-up battery. With a press to the joystick it is possible to "awake" the device and enter Display mode (with the "plug" symbol displayed). A further press to  will enter the program or set-up mode as explained in the Display mode section above.

After about 1 minute of inactivity the power-save mode will start again. During program or set-up the current absorption is higher than in power-save mode, thus influencing the battery life.

In this mode the display back-light is not active. It is activated following a press to the joystick only with the 230 V AC supply connected, but after about 1 minute of inactivity the display back-light will turn off, and to activate it again it is necessary to press the joystick again.

Note: the output relay only functions if the power supply is connected.

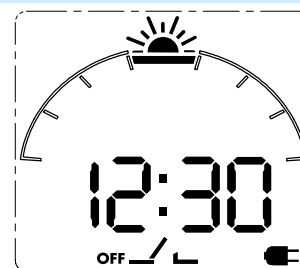

Accessories type 12.51, 12.61, 12.62, 12.81, 12.A1, 12.A2



011.01

Adaptor for panel mounting, 35 mm wide

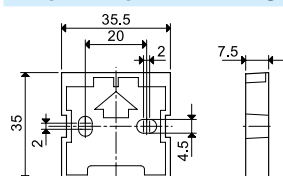

011.01

Electronic staircase timers 16 A



Staircase
light control



14
SERIES

**Multi-function electronic staircase timers
1 NO 16 A 17.5 mm wide**

Type 14.01

- 8 functions
- Switch-off "early warning" options

Type 14.71

- 3 functions
- Time setting from 30 seconds to 20 minutes
- "Zero crossing" load switching
- Suitable for 3 or 4 wire systems, with automatic recognition
- Compatible with movement detectors (18 series)
- LED status indicators
- Cadmium free contact material
- Can be used with illuminated push - buttons
- "Blade + cross" - both flat blade and cross head screw drivers can be used to adjust the function selector, the timing trimmer, and to disengage the 35 mm rail mounting clip
- 35 mm rail (EN 60715) mount
- European Patent

14.01/71
Screw terminal



For outline drawing see page 10

Contact specification

Contact configuration		1 NO (SPST-NO)	1 NO (SPST-NO)
Rated current/Maximum peak current	A	16/30 (120 A - 5 ms)	16/30 (120 A - 5 ms)
Rated voltage/ Maximum switching voltage	V AC	230/—	230/—
Rated load AC1	VA	3700	3700
Rated load AC15 (230 V AC)	VA	750	750
Nominal lamp rating:			
230 V incandescent/halogen W		3000	3000
fluorescent tubes with electronic ballast W		1500	1500
fluorescent tubes with electromagnetic ballast W		1000	1000
CFL W		600	600
230 V LED W		600	600
LV halogen or LED with electronic ballast W		600	600
LV halogen or LED with electromagnetic ballast W		1500	1500
Minimum switching load	mW (V/mA)	1000 (10/10)	1000 (10/10)
Standard contact material		AgSnO ₂	AgSnO ₂

Supply specification

Nominal voltage (U _N)	V AC (50/60 Hz)	230	230
	V DC	—	—
Rated power	VA (50 Hz)/W	3/1.2	3/1.2
Operating range	AC (50 Hz)	(0.8...1.1)U _N	(0.8...1.1)U _N
	DC	—	—

Technical data

Electrical life at rated load in AC1	cycles	100 · 10 ³	100 · 10 ³
Delay setting	min	0.5...20	0.5...20
Max no. of illuminated push-button (≤ 1 mA)		30	30
Maximum impulse duration		continuous	continuous
Ambient temperature range	°C	-10...+60	-10...+60
Protection category		IP 20	IP 20

Approvals (according to type)



14.01



- 8 functions:
 - Staircase timer
 - Staircase timer + maintenance function
 - Staircase timer with early warning
 - Staircase timer with early warning + maintenance function
 - Timing step relay
 - Timing step relay with early warning
 - Step relay
 - Light ON

14.71



- 3 functions:
 - Staircase timer
 - Staircase timer + maintenance function
 - Light ON

**Mono-function electronic staircase timers
1 NO 16 A 17.5 mm wide**
Type 14.81

- Staircase timer + maintenance function

Type 14.91

- Signal ON pulse timer
- Time setting from 30 seconds to 20 minutes
- "Zero crossing" load switching
- Wiring compatible with mechanical versions and with old type (low emission) illuminated pushbuttons
- Suitable for 3 or 4 wire systems, via "pushbutton configuration"
- 110...125 V AC supply version available (14.81)
- Cadmium free contact material
- Can be used with illuminated push - buttons
- "Blade + cross" - both flat blade and cross head screw drivers can be used to adjust the function selector, the timing trimmer, and to disengage the 35 mm rail mounting clip
- 35 mm rail (EN 60715) mount

14.81/91

Screw terminal



For outline drawing see page 10

Contact specification

Contact configuration		14.81	14.91
Contact configuration		1 NO (SPST-NO)	1 NO (SPST-NO)
Rated current/Maximum peak current	A	16/30 (120 A - 5 ms)	16/30 (120 A - 5 ms)
Rated voltage/ Maximum switching voltage	V AC	230/—	230/—
Rated load AC1	VA	3700	3700
Rated load AC15 (230 V AC)	VA	750	750
Nominal lamp rating:			
230 V incandescent/halogen W		3000	3000
fluorescent tubes with electronic ballast W		1500	1500
fluorescent tubes with electromagnetic ballast W		1000	1000
CFL W		600	600
230 V LED W		600	600
LV halogen or LED with electronic ballast W		600	600
LV halogen or LED with electromagnetic ballast W		1500	1500
Minimum switching load	mW (V/mA)	1000 (10/10)	1000 (10/10)
Standard contact material		AgSnO ₂	AgSnO ₂

Supply specification

Nominal voltage (U _N)	V AC (50/60 Hz)	110...125/230	230
	V DC	—	—
Rated power	VA (50 Hz)/W	3/1.2	3/1.2
Operating range	AC (50 Hz)	(0.8...1.1)U _N	(0.8...1.1)U _N
	DC	—	—

Technical data

Electrical life at rated load in AC1	cycles	100 · 10 ³	100 · 10 ³
Delay setting	min	0.5...20	0.5...20
Max no. of illuminated push-button (≤ 1 mA)		25	25
Maximum impulse duration		continuous	continuous
Ambient temperature range	°C	-10...+60	-10...+60
Protection category		IP 20	IP 20

Approvals (according to type)

14.81

- Mono-function:
 - Staircase timer + maintenance function
- All 4 terminal on same side

14.91

- Mono-function:
 - Signal ON pulse timer
- All 3 terminal on same side

Ordering information

Example: 14 series multi-function timer, 1 NO (SPDT-NO) 16 A contact, supply rated at 230 V AC.



Series

Type

- 0 = 35 mm rail (EN 60715) mount, 8 functions
- 7 = 35 mm rail (EN 60715) mount, 3 functions
- 8 = 35 mm rail (EN 60715) mount, mono-function, all terminals on same side
- 9 = 35 mm rail (EN 60715) mount, mono-function, 3 terminals

No. of poles

1 = 1 NO 16 A contact

Supply voltage

- 120 = 110...125 V AC (14.81 only)
- 230 = 230 V

Supply version

8 = AC (50/60 Hz)

Technical data

Insulation

Dielectric strength between open contacts V AC 1000

Other data

Power lost to the environment

without contact current	W	1.2
with rated current	W	2

Maximum cable length for push-button connection m 200

Screw torque Nm 0.8

Max. wire size

	solid cable	stranded cable
mm ²	1 x 6 / 2 x 4	1 x 4 / 2 x 2.5
AWG	1 x 10 / 2 x 12	1 x 12 / 2 x 14

Zero crossing switching

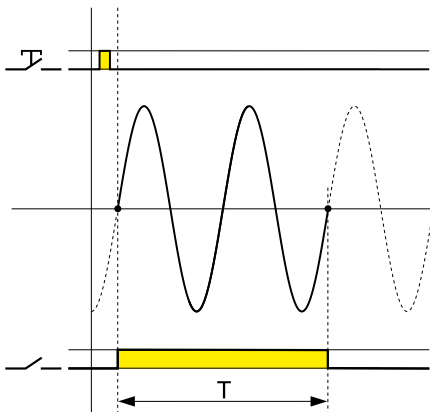

- 1 - Lower inrush current protects and increases lamp life
- 2 - Lower inrush current reduces the possibility of contact welding
- 3 - The current at switch-off is also lower, reducing stress and wear on the contacts

Note

Using the type 14.91, the lamps are switched on directly by the push-button

Accessories



020.01

Adaptor for panel mounting, 17.5 mm wide

020.01

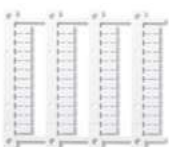

060.48

Sheet of marker tags (CEMBRE Thermal transfer printers), plastic, 48 tags, 6 x 12 mm

060.48

Wiring diagrams

Type 14.01

14.71

Red LED indication:

Continuous = relay ON

Blinking = relay OFF

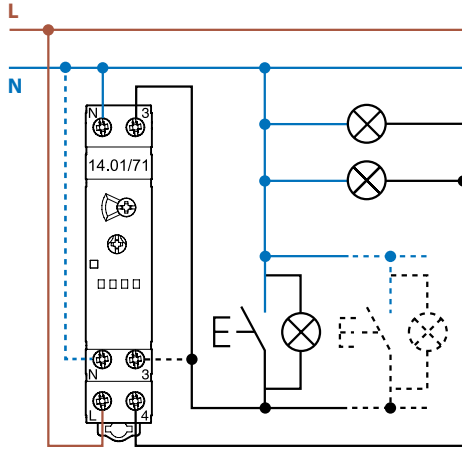

3 wire connection

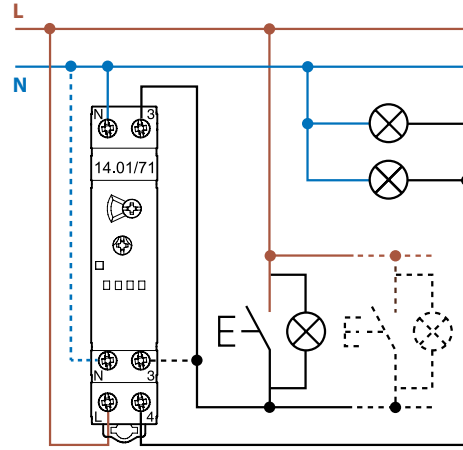

4 wire connection

Type 14.81 (push-button configuration procedure, as per the Installation manual)

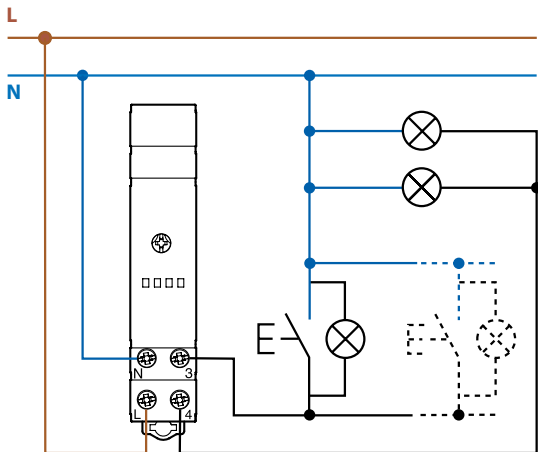

3 wire connection

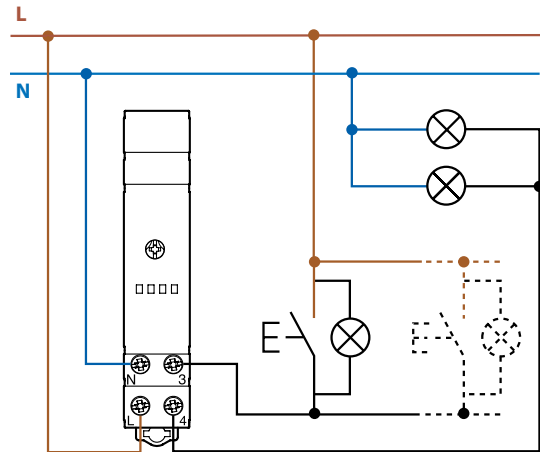

4 wire connection

Type 14.91 (the push-buttons must be rated for the load current)

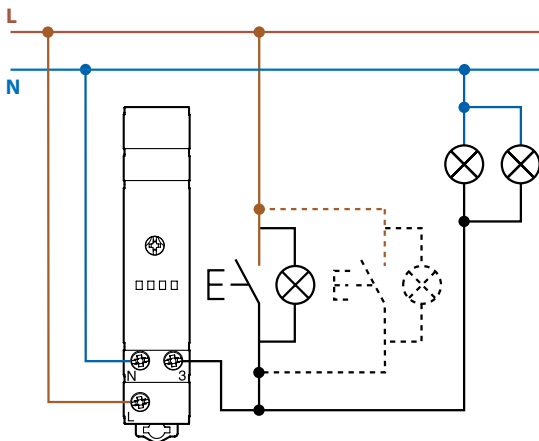

Wiring diagrams - 14.01 or 14.71 without Staircase maintenance function, triggered by PIR movement detector (18 series).

3 wire connection (with 18.21.8.230.0300 or 18.31.8.230.0300 only)

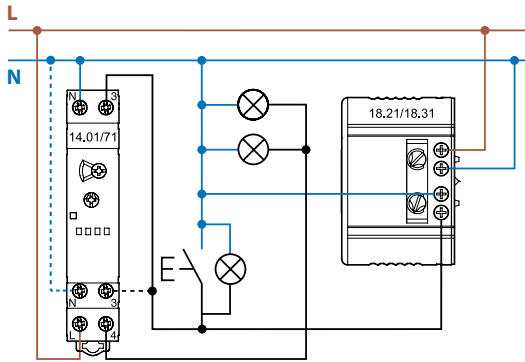

4 wire connection (with 18.21.8.230.0300 or 18.31.8.230.0300 only)

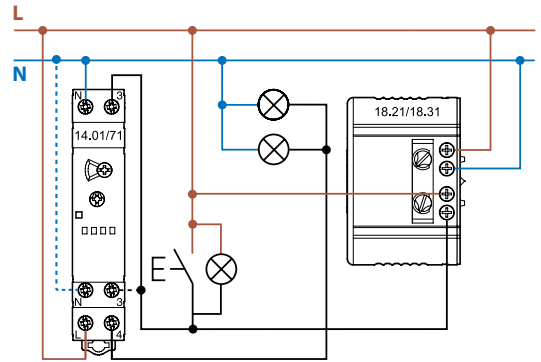

4 wire connection (with 18.01.8.230.0000 or 18.11.8.230.0000 only)

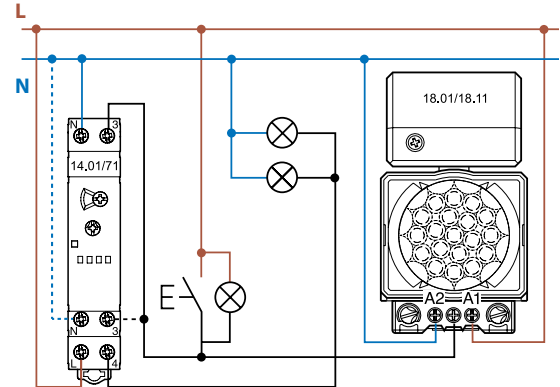

Functions

Type 14.01 Functions selectable with front rotary selector

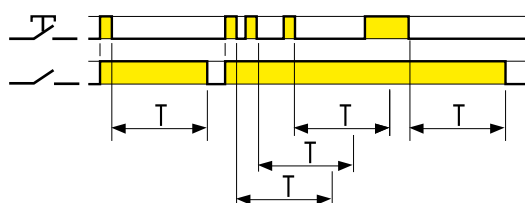

(BE) Staircase timer

On initial impulse the output contact closes and timing starts for the pre-set duration; subsequent impulses during the timing period will extend the timing period by the full pre-set value.

On expiry of the time delay, the output contact opens.

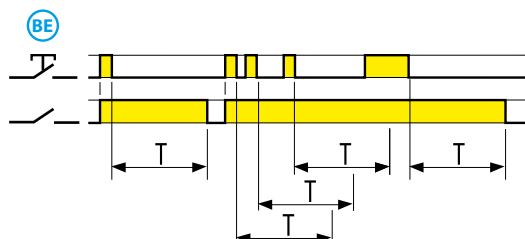

(ME) Staircase timer + Staircase maintenance

In addition to the Staircase timer function (BE), an impulse of ≥ 5 seconds will close the output contact for 60 minutes, after which time the contact will open. Ideal for maintenance or cleaning activities. The 60 minute timing can be interrupted by a further impulse of ≥ 5 seconds, and the output contact then opens

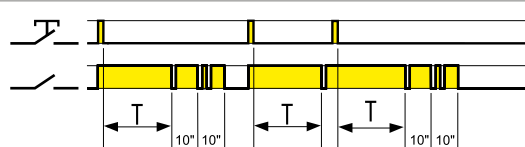

(BP) Staircase timer with early warning

On initial impulse the output contact closes and the timing starts for the pre-set duration. After the timing period, the output contact blinks off once; 10secs later the contact blinks off twice, and after a further 10secs the contact opens.

During the pre-set and 20 second warning time, it is possible, by a further impulse, to extend the time by the full pre-set value.

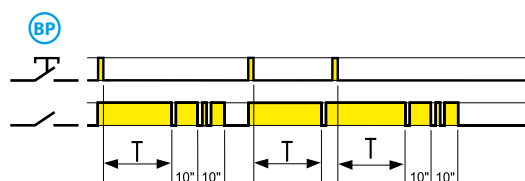

(MP) Staircase timer with early warning + Staircase maintenance

In addition to the Staircase timer function (BP), an impulse of ≥ 5 seconds will close the output contact for 60 minutes, after which time the contact will open. Ideal for maintenance or cleaning activities. The 60 minute timing can be interrupted by a further impulse of ≥ 5 seconds, and the output contact then opens

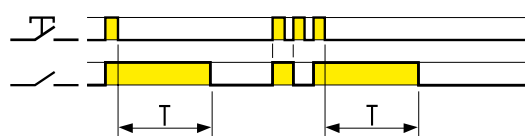

(IT) Timing step relay

On initial impulse the output contact closes and timing starts for the pre-set duration; On expiry of the time delay, the output contact opens.

During the timing period it is possible to immediately open the contact with a further impulse.

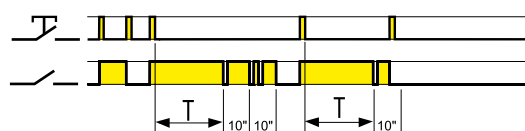

(IP) Timing step relay with early warning

On initial impulse the output contact closes and timing starts for the pre-set duration; After the timing period, the output contact blinks off once; 10 secs later the contact blinks off twice, and after a further 10 secs the contact opens.

During the pre-set and 20 second warning time, it is possible to immediately open the output contact by a further impulse.



(RI) Step relay

After every impulse, the output contact changes state - alternately switching from open to closed and vice versa.

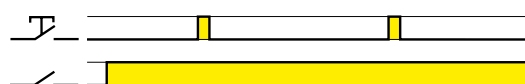

Light ON

With this function set - the output contact stays permanently closed.

NOTE: The blinking within the Early Warning functions (BP and IP) could cause re-start problems for fluorescent lamps with electromagnetic chokes (both conventional and compact types); We consequently suggest not to use such lamps with these functions.

Functions

Type 14.71 Functions selectable with front selector

3-function front selector

	⌚ Staircase timer + 🚧 Staircase maintenance
	⚙️ Light ON
	⌚ Staircase timer (compatible with 18 series movement detectors)

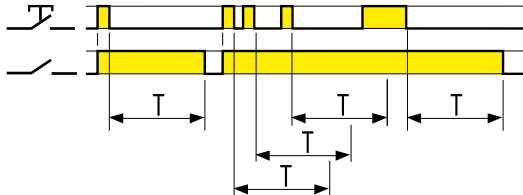

⌚ Staircase timer

On initial impulse the output contact closes and timing starts for the pre-set duration; subsequent impulses during the timing period will extend the timing period by the full pre-set value. On expiry of the time delay, the output contact opens.

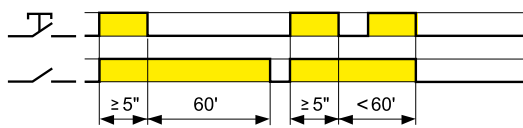

🚧 Staircase maintenance

An impulse of ≥ 5 seconds will close the output contact for 60 minutes, after which time the contact will open. Ideal for maintenance or cleaning activities. The 60' timing can be interrupted by a further impulse of ≥ 5 seconds, the output contact opens.

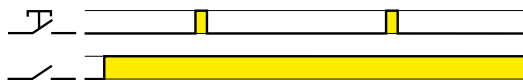

⚙️ Light ON

With this function set - the output contact stays permanently closed.

Type 14.81

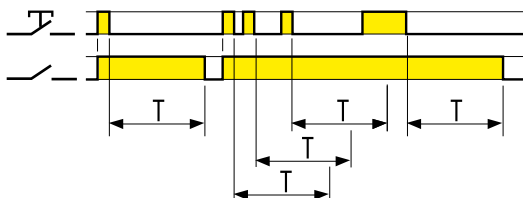

Staircase timer

On initial impulse the output contact closes and timing starts for the pre-set duration; subsequent impulses during the timing period will extend the timing period by the full pre-set value. On expiry of the time delay, the output contact opens.

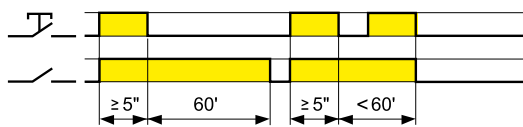

"Staircase maintenance" function

An impulse of ≥ 5 seconds will close the output contact for 60 minutes, after which time the contact will open. Ideal for maintenance or cleaning activities. The 60' timing can be interrupted by a further impulse of ≥ 5 seconds, which will re-establish the staircase timer function; so on expiry of the staircase time delay, the output contact opens.

Type 14.91

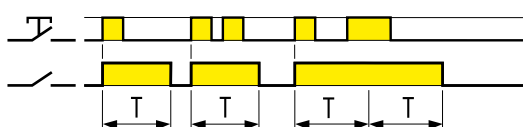

Signal ON pulse

On initial impulse the output contact closes, and remain so for the duration of the preset delay. On expiry of the time delay, the output contact opens.

Outline drawings

14.01
Screw terminal

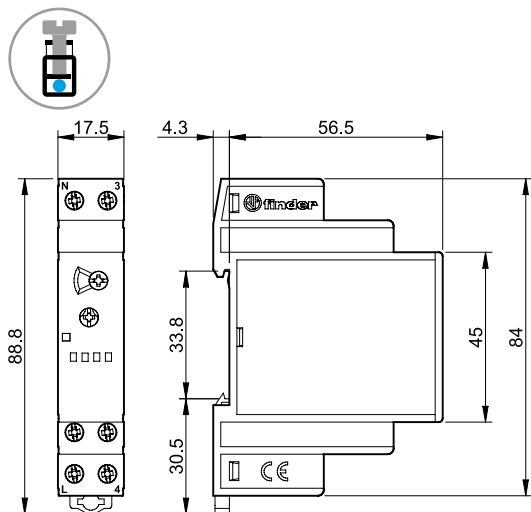

14.71
Screw terminal

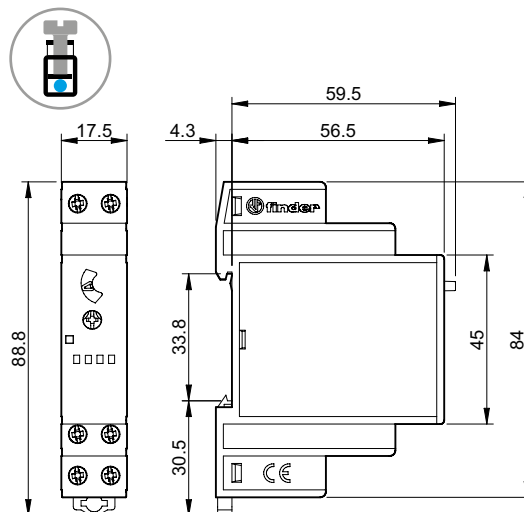

14.81
Screw terminal

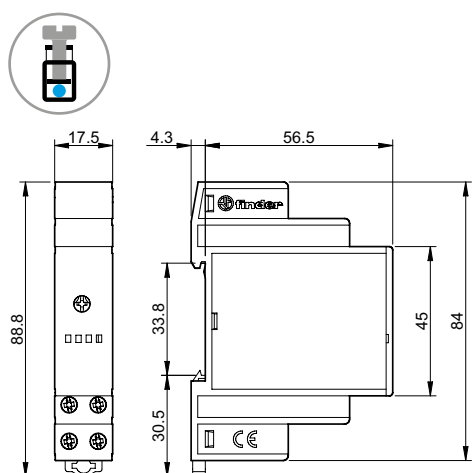

14.91
Screw terminal

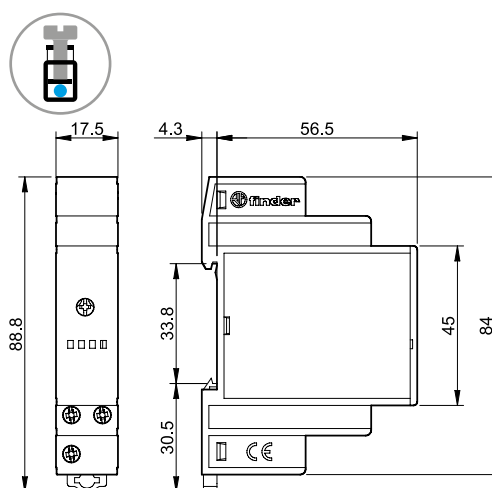

Dimmers



Kitchen
light control



Bedroom
light control



Living room
light control



Lighting control
in corridors
(for hotels, offices
and hospitals)



15
SERIES

“Master + Slave” system for dimming multiple lighting loads of either single or mixed lamp technologies

Type 15.10 “Master” - accepts input from a controlling push-button and outputs a dimming signal to a maximum of 32 x 15.11 slave dimmers, or other drivers or luminaires accepting a standardised 0-10 V/1-10 V signal

- Use with 4 wire connection
- “Soft” On and Off transitions
- Linear dimming
- Selectable operating modes with or without previous light level memory
- Staircase timer function

Type 15.11 “Slave” - accepts 1-10 V input from a 15.10 or other 0-10 V/1-10 V output device to dim a wide variety of lamps of different technology

- Selector switch for incandescent and halogen lighting loads (with or without transformer or electronic driver)
- Compatible with energy saving dimmable CFL or LED lamps and with all types of electromagnetic transformers
- Thermal protection against overload, thermofuse for extreme or short-circuit protection

Screw terminal



* Maximum peak current of the contact 30 A 230 V AC. Use a contactor or power relay to switch loads exceeding this value

For outline drawing see page 11

“Master Dimmer” output specifications

Driving signal (Output mode automatically configures to match input mode of the connected Driver)

Contact configuration A

“Slave Dimmer” output specifications

Power max. W

Power min. W

Nominal lamp ratings:

230 V incandescent or halogen W	—
Toroidal electromagnetic transformers for LV halogen W	—
E-core electromagnetic transformers for LV halogen W	—
Electronic transformers (or ballasts) for LV halogen W	—
Dimmable compact fluorescent (CFL) W	—
Dimmable 230 V LED W	—
Dimmable electronic transformers for LV LED W	—

Supply specification

Nominal voltage (U_N) V AC (50/60 Hz)

Operating range (0.8...1.1) U_N

Stand-by power consumption W

Dimming operating modes

Technical data

Dimming speed (total dimming time) s

Delay setting (staircase function) min

Max no. of illuminated push-button (≤ 1 mA)

Ambient temperature range °C

Protection category

Approvals (according to type)



Note (1) Select “trailing edge” (⚙️) position on the front selector.

(2) Select “transformer” (⚡️) position on the front selector. Preferably, no more than 2 transformers.

(3) Select “leading edge” (⚡️) position on the front selector, and set the appropriate minimum dimming value (dependent on lamp type).

(4) With lamp load > 300 W (> 75 W for CFL or LED lamps), adequate ventilation must be provided - a gap of 9 mm on both side of the dimmer is suggested. Use the plastic separator type 022.09.

NEW 15.10



NEW 15.11



“Master” dimmer

- 0-10 V/1-10 V output to drive up to 32 x 15.11 slave dimmers or other similar devices
- Multi-function (with or without memory, including special “CFL with memory” function)
- Linear dimming
- Dimming speed setting
- Staircase timer function, with switch-off “early warning” signalled by lamps dimming
- 230 V AC supply, 50/60 Hz with automatic adjustment for frequency
- 6 A output relay contact*
- 17.5 mm wide, modular, 35 mm rail mount

“Slave” dimmer

- 1-10 V input, driven by 15.10 or by other 0-10 V/1-10 V output devices
- Maximum lamp load 400 W
- 100 W load with energy saving dimmable lamps (LED and CFL)
- Leading and trailing edge dimming methods
- “Transformer” function (for use with electromagnetic transformers)
- Minimum dimming level setting
- 17.5 mm wide, modular, 35 mm rail mount

0-10 V, +35 mA max (Active current sourcing mode)	—
1-10 V, -35 mA max (Passive current sinking mode)	—
1 NO (6 A/230 V AC)*	—

Power max. W	—	400
Power min. W	—	3
Nominal lamp ratings:		
230 V incandescent or halogen W	—	400 ⁽¹⁾
Toroidal electromagnetic transformers for LV halogen W	—	400 ⁽²⁾
E-core electromagnetic transformers for LV halogen W	—	400 ⁽²⁾
Electronic transformers (or ballasts) for LV halogen W	—	400 ⁽¹⁾
Dimmable compact fluorescent (CFL) W	—	100 ⁽³⁾
Dimmable 230 V LED W	—	100 ^{(3) or (1)}
Dimmable electronic transformers for LV LED W	—	100 ⁽¹⁾
Nominal voltage (U _N) V AC (50/60 Hz)	110...230	230
Operating range	(0.8...1.1) U _N	(0.8...1.1) U _N
Stand-by power consumption W	0.5	0.5
Dimming operating modes	—	Trailing edge (⚙️) Leading edge (⚡️) and (⚡️)
Dimming speed (total dimming time) s	1.5...10	—
Delay setting (staircase function) min	0.5...20	—
Max no. of illuminated push-button (≤ 1 mA)	15	—
Ambient temperature range °C	-10...+50	-10...+50 ⁽⁴⁾
Protection category	IP 20	IP 20

Electronic dimmers for lamps of various technologies. All compatible with the direct drive of Incandescent/halogen lamps and 230 V dimmable LED lamps (Other lamps/drivers according to Type)

Type 15.91

- Mountable in wall box
- Leading edge dimming
- Linear dimming
- Automatically adjusts for supply frequency

Type 15.51

- Wall box or panel mount
- Trailing edge dimming
- Step or linear dimming
- Separate models for 50 and 60 Hz

Type 15.81

- 35 mm rail mount
- Leading or trailing edge dimming
- Also compatible with energy saving (CFL or LED) dimmable lamps and with most types of transformer/ballast drivers
- Linear dimming
- Automatically adjusts for supply frequency
- Thermo-fuse for extreme protection
- All Types suitable for incandescent and halogen lighting loads
- Use with 3 or 4 wire connection
- "Soft" On and Off transitions
- Two selectable operating modes: with or without previous light level memory
- Thermal protection against overload

Screw terminal





For outline drawing see page 11

Output data

	V AC	230	230	230
Rated voltage				
Power max.	W	100	400	500
Power min.	W	3	10	3
Nominal lamp ratings:				
230 V incandescent or halogen W		100	400	500 ⁽¹⁾
Toroidal electromagnetic transformers for LV halogen W		—	300 ⁽²⁾	500 ⁽³⁾
E-core electromagnetic transformers for LV halogen W		—	—	500 ⁽³⁾
Electronic transformers (or ballasts) for LV halogen W		—	400 ⁽⁴⁾	500 ⁽¹⁾
Dimmable compact fluorescent (CFL) W		—	—	100 ⁽⁵⁾
Dimmable 230 V LED W		50 ⁽⁶⁾	50 ⁽⁷⁾	100 ⁽⁵⁾
Dimmable electronic transformers for LV LED W		50 ⁽⁶⁾	50 ⁽⁷⁾	100 ⁽¹⁾

Supply specification



Nominal voltage (U _N)	V AC (50/60 Hz)	230	230 ⁽⁸⁾	230
Operating range		(0.8...1.1)U _N	(0.8...1.1)U _N	(0.8...1.1)U _N
Stand-by power consumption	W	0.4	0.7	0.5
Dimming operating mode		Leading edge	Trailing edge	Trailing edge () Leading edge () and ()

Technical data

Ambient temperature range	°C	-10...+50 ⁽⁹⁾	-10...+50 ⁽⁹⁾	-10...+50 ⁽¹⁰⁾
Protection category		IP 20	IP 20	IP 20

Approvals (according to type)



- Note**
- (1) Select "incandescent lamp" () position on the front selector.
 - (2) One transformer only. Power-up only with the lamp load connected.
 - (3) Select "transformer" () position on the front selector. Preferably, no more than 2 transformers.
 - (4) One transformer only.
 - (5) Select "CFL" () position on the front selector, and set the appropriate minimum dimming value (dependent on lamp type).
 - (6) Only if lamps or electronic transformers are compatible with leading edge method.
 - (7) Only if lamps or electronic transformers are compatible with trailing edge method.
 - (8) Specific 60 Hz version available (see ordering information).
 - (9) It is not recommended to mount more than one dimmer in the same wall box, unless adequate ventilation is provided or the lamp load is less than 100 W (15.51) or 50 W (15.91).
 - (10) With lamp load > 300 W (> 75 W for CFL or LED lamps), adequate ventilation must be provided - a gap of 9 mm on both side of the dimmer is suggested. Use the plastic separator type 022.09.
- Not compatible with illuminated push-buttons.

15.91



15.51



15.81



- Suitable for residential wall box mounting
- Maximum lamp load 100 W
- Leading edge dimming
- 2 modes - with or without memory
- 230 V AC supply, 50/60 Hz (with automatic adjustment for frequency)
- Linear dimming

- Suitable for wall box or panel mounting
- Maximum lamp load 400 W
- Trailing edge dimming
- Step or Linear dimming
- 2 modes - with or without memory
- 230 V AC supply (separate models for 50 and 60 Hz)

- 17.5 mm modular, 35 mm rail mount
- Maximum lamp load 500 W
- Multi-function
- Leading and trailing edge dimming methods (depending on the function)
- Compatible with energy saving (CFL or LED) dimmable lamps and most types of transformer/ballast drivers
- 230 V AC supply, 50/60 Hz (with automatic adjustment for frequency)

Ordering information

Example: type 15.91, Dimmer, 230 V AC.

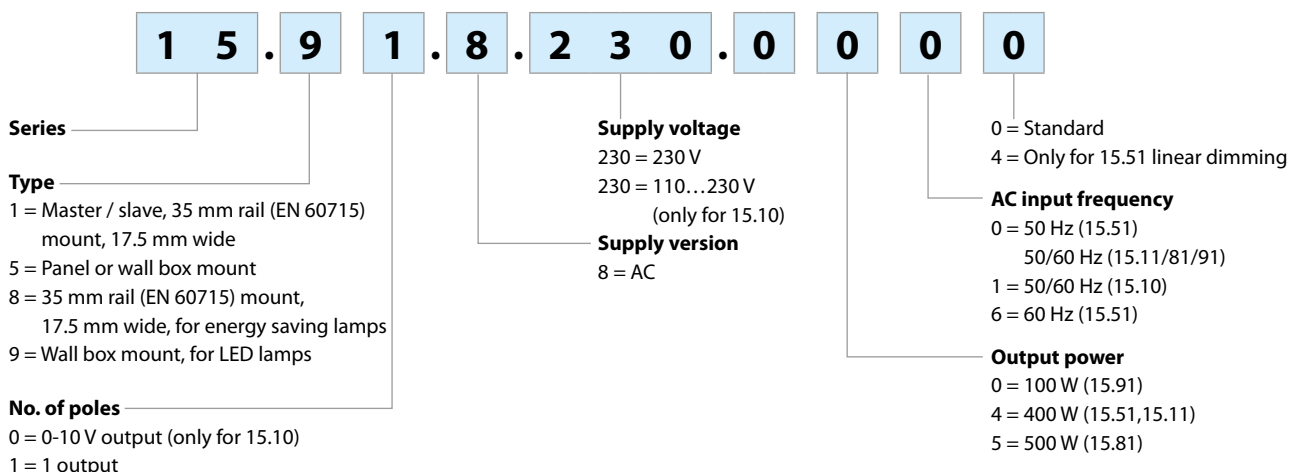

Codes

- 15.10.8.230.0010 master dimmer, 50/60 Hz
- 15.11.8.230.0400 slave dimmer, 50/60 Hz
- 15.51.8.230.0400 step dimming, 50 Hz
- 15.51.8.230.0404 linear dimming, 50 Hz
- 15.51.8.230.0460 step dimming, 60 Hz
- 15.81.8.230.0500 linear dimming, 50/60 Hz
- 15.91.8.230.0000 linear dimming, 50/60 Hz

Technical data

EMC specifications							
Type of test		Reference standard	15.51/15.91	15.10/11/81			
Electrostatic discharge	contact discharge	EN 61000-4-2	4 kV				
	air discharge	EN 61000-4-2	8 kV				
Radiated electromagnetic field	(80...1000 MHz)	EN 61000-4-3	3 V/m	10 V/m			
Fast transients (burst) (5-50 ns, 5 and 100 kHz)	on supply terminals	EN 61000-4-4	4 kV				
	on pushbutton connection	EN 61000-4-4	4 kV				
Voltage pulses on supply terminals (surge 1.2/50 μs)	differential mode	EN 61000-4-5	2 kV				
Radiofrequency common mode voltage (0.15...80 MHz)	on supply terminals	EN 61000-4-6	3 V				
	on pushbutton connection	EN 61000-4-6	3 V				
Voltage dips	70% U _N , 40% U _N	EN 61000-4-11	10 cycles				
Short interruptions		EN 61000-4-11	10 cycles				
Radiofrequency conducted emissions	0.15...30 MHz	EN 55014	class B				
Radiated emissions	30...1000 MHz	EN 55014	class B				
Terminals		solid cable	stranded cable				
Max. wire size	mm ²	1 x 6 / 2 x 4	1 x 4 / 2 x 2.5				
	AWG	1 x 10 / 2 x 12	1 x 12 / 2 x 14				
Screw torque	Nm	0.8					
Wire strip length	mm	9					
Other data		15.10	15.11	15.51	15.81	15.91	
Power lost to the environment	without load	W	0.5	0.5	0.7	0.5	0.4
	with rated load	W	1.7	2.5	2.2	2.6	1.2
Max cable length for push-button connection	m	100	100	100	100	100	
Max cable length for Master and Slaves connection	m	100 (keep separate from power cables)					

Signaling

LED (15.10 only)	Condition
	Stand-by, output voltage < 1 V
	Active, output voltage ≥ 1 V
	Timing, staircase function

LED (15.11 only)	Condition
	Stand-by, input voltage < 1 V
	Active, input voltage ≥ 1 V
	Short circuit or overload, output disabled
	Overtemperature, output disabled

Functions - Type 15.10 and 15.11

Type Linear dimming

15.10		<p>Operating mode without memory: at switch-off, the light level is not memorized.</p> <p>Long control pulse: The light level is progressively raised or lowered in linear way. The lowest value depending on the "minimum dimming level" regulator setting (on 15.11).</p> <p>Short control pulse: Alternately switches between On and Off (maximum light level and the off state).</p>
		<p>Operating mode with memory: the previous light level is memorized.</p> <p>Long control pulse: The light level is progressively raised or lowered in linear way. The lowest value dependent on the "minimum dimming level" regulator setting (on 15.11).</p> <p>Short control pulse: Alternately switches between On and Off. When switching On, the light level assumes the value set during the previous On state.</p>
		<p>Operating mode with memory: the previous light level is memorized, specific for CFL Lamp.</p> <p>Long control pulse: The light level is progressively raised or lowered in linear way. The lowest value dependent on the "minimum dimming level" regulator setting (on 15.11).</p> <p>Short control pulse: Alternately switches between On and Off. When switching On, the light level reach the full value for a very short time (in order to guarantee the correct lamp turn-on), then immediately assumes the value set during the previous On state.</p>
		<p>Staircase relay with early warning On initial impulse the output closes and the timing starts for the pre-set duration. After the timing period (T), the output power is reduced to 50% for 10 seconds; then in the last 30 seconds it will be further reduced to the final shutdown. During the pre-set and 40 seconds warning time, it is possible, by a further impulse, to extend the time by the full pre-set value.</p>

Type of load - Type 15.11

Type of load	Selector setting	Regulator setting
<ul style="list-style-type: none"> Incandescent lamps 230 V halogen lamps 12/24 V halogen and LED lamps with electronic transformer/ballast 	<p>(Trailing Edge)</p>	<p>It is suggested to set the "minimum dimming level" at the lowest value, so that the complete dimming range is available. But if it is necessary to avoid too low a level of illumination, a higher value can be set.</p>
<ul style="list-style-type: none"> Dimmable compact fluorescent lamps (CFL) Dimmable LED lamps 	<p>(Leading Edge)</p>	<p>It is suggested to initially set the "minimum dimming level" at an intermediate value and then if necessary, readjust for a level found to be compatible with the lamp being used.</p>
<ul style="list-style-type: none"> 12/24 V halogen lamps with toroidal or E-core electromagnetic transformer 	<p>(Leading Edge)</p>	<p>It is suggested to set the "minimum dimming level" at the lowest value, so that the complete dimming range is available. But if it is necessary to avoid too low a level of illumination, a higher value can be set.</p>

Functions - Type 15.51 and 15.91

Type

Step dimming

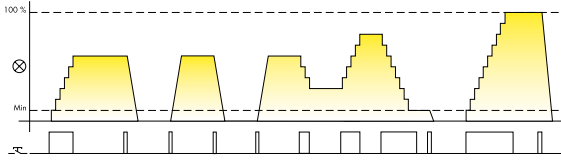
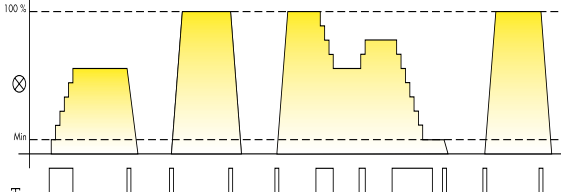
<p>15.51...0400</p>	<p>Operating mode 1 (with memory): the previous light level is memorized.</p>  <p>Long control pulse: The light level is progressively raised or lowered through a maximum of 10 incremental steps.</p> <p>Short control pulse: Alternately switches between On and Off. When switching On, the light level assumes the value set during the previous On state.</p>
	<p>Operating mode 2 (without memory): on switch off, the light level is not memorized.</p>  <p>Long control pulse: The light level is progressively raised or lowered through a maximum of 10 incremental steps.</p> <p>Short control pulse: Alternately switches On or Off between the maximum light level and the off state.</p>

Type

Linear dimming

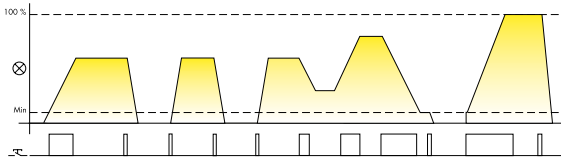
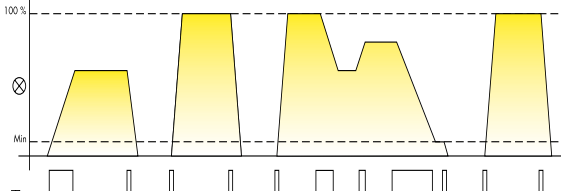
<p>15.51...0404 15.91...0000</p>	<p>Operating mode 3 (with memory): the previous light level is memorized.</p>  <p>Long control pulse: The light level is progressively raised or lowered.</p> <p>Short control pulse: Alternately switches between On and Off. When switching On, the light level assumes the value set during the previous On state.</p>
	<p>Operating mode 4 (without memory): on switch off, the light level is not memorized.</p>  <p>Long control pulse: The light level is progressively raised or Lowered.</p> <p>Short control pulse: Alternately switches On or Off between the maximum light level and the off state.</p>

Operating mode setup

Type 15.51

On 15.51 operating mode 1 or 3 (with memory) is preset, but it is possible to change it using the following sequence:

- remove the supply voltage;
- press the control button;
- apply the supply to the relay, keeping the button closed for 3 second;
- on button release, the light will flash twice to indicate the selection of operating mode 2 or 4, or flash once for operating mode 1 or 3.

Repeating the above steps will alternately change between operating modes.

Type 15.91

On 15.91 operating mode 4 (without memory) is preset, but it is possible to change it using the following sequence:

- remove the supply voltage;
- press the control button;
- apply the supply to the relay, keeping the button closed for 3 second;
- on button release, the light will flash twice to indicate the selection of operating mode 3, or flash once for operating mode 4.

Repeating the above steps will alternately change between operating modes.

Thermal protection and signaling

LED (15.81 type only)	Supply voltage	Thermal protection
	OFF	—
	ON	—
	ON	ALARM

ALARM

The internal thermal protection (active on all dimmer types) will detect an unsafe temperature, due to overload or incorrect installation, and will turn the dimmer output off. It is possible to turn the dimmer on, by push button, only when the temperature reduces to a safe level (after 1 to 10 minutes, depending on installation conditions) and after removing the cause of the overload.

Functions - Type 15.81

Type **Linear dimming**

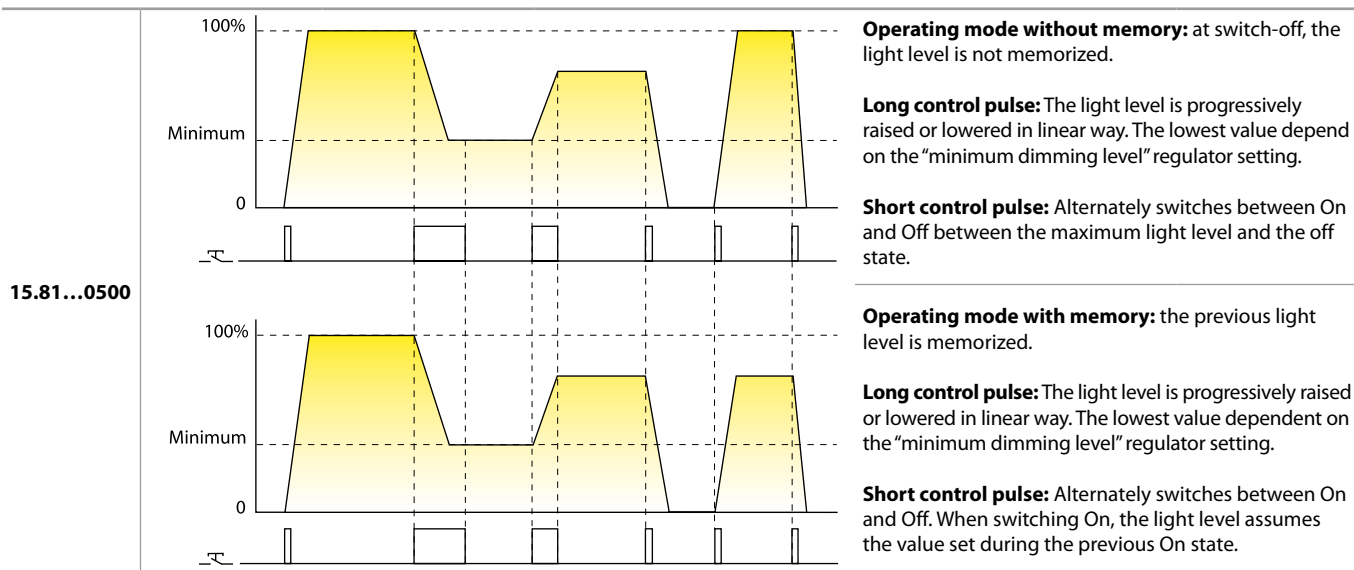

Operating mode without memory: at switch-off, the light level is not memorized.

Long control pulse: The light level is progressively raised or lowered in linear way. The lowest value depend on the "minimum dimming level" regulator setting.

Short control pulse: Alternately switches between On and Off between the maximum light level and the off state.

Operating mode with memory: the previous light level is memorized.

Long control pulse: The light level is progressively raised or lowered in linear way. The lowest value dependent on the "minimum dimming level" regulator setting.

Short control pulse: Alternately switches between On and Off. When switching On, the light level assumes the value set during the previous On state.

Type of load	Selector setting		Regulator setting
	With memory (M)	Without memory (M)	
<ul style="list-style-type: none"> Incandescent lamps 230 V halogen lamps 12/24 V halogen lamps with electronic transformer/ballast 			It is suggested to set the "minimum dimming level" at the lowest value, so that the complete dimming range is available. But if it is necessary to avoid too low a level of illumination, a higher value can be set.
<ul style="list-style-type: none"> Dimmable compact fluorescent lamps (CFL) Dimmable LED lamps 			It is suggested to initially set the "minimum dimming level" at an intermediate value and then if necessary, readjust for a level found to be compatible with the lamp being used.
<ul style="list-style-type: none"> 12/24 V halogen lamps with toroidal or E-core electromagnetic transformer 			It is suggested to set the "minimum dimming level" at the lowest value, so that the complete dimming range is available. But if it is necessary to avoid too low a level of illumination, a higher value can be set.

Leading edge dimming

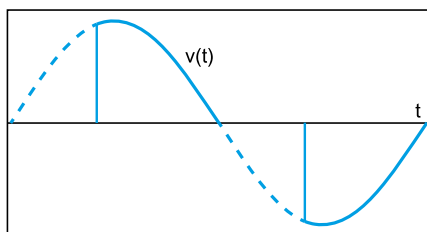

Trailing edge dimming

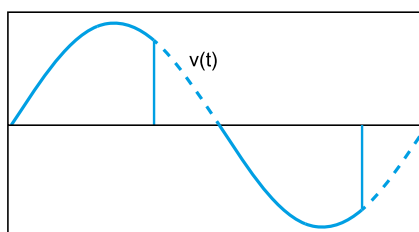

Light dimming is realized with "phase cutting technology", which works by "cutting off" part of the mains voltage waveform in order to reduce the RMS voltage fed to the lamp. When the "cut off" part is at the beginning of each half cycle the dimming method is called Leading Edge. When it is towards the end of each half cycle, it is called Trailing Edge. These 2 methods are suitable for dimming different lamp types: Trailing Edge is, in general, more suitable for electronic transformers for low voltage lamps (halogen or LED). Leading Edge is better suited for electromagnetic transformers for LV lamps, 230 V CFL and 230 V LED lamps. Both methods are, however, suitable for dimming 230 V halogen and incandescent lamps.

In consideration of the different lamp types actually available on the market, it is suggested to refer to the technical specification indicated in page 3 and, if given, to the lamp manufacturer's recommendation.

Wiring diagrams - Types 15.10 and 15.11

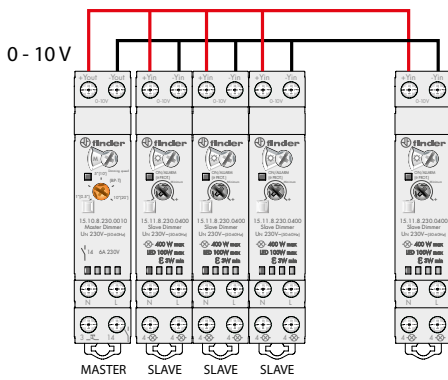

This new system is modular, adaptable to every need and allows control of multiple lamps through a single control device called the "Master Dimmer" Type 15.10.8.230.0010.

The Master Dimmer, produces a 0 - 10 V signal proportional to the dimming value needed: 0 V corresponds to 0% (light off); 5 V equals 50%, 10 V corresponds to the maximum brightness (100% on).

The 0 - 10 V output signal terminals Yout + / Yout - of the "Master Dimmer" must be connected to terminals + Yin / Yin - of one or more 15.11.8.230.0400, called the "Slave Dimmers", which have the task of changing the voltage applied to the lamps and therefore their brightness.

The result is a flexible system that offers a range of solutions from the minimum configuration of a Master Dimmer and a Slave Dimmer, up to the maximum configuration of a Master Dimmer and 32 Slave Dimmers.

Each slave can drive a different lamp type, depending on the appropriate methodology, "Leading Edge" or "Trailing Edge". It can regulate halogen lamps, dimmable LED lamps, dimmable CFL lamps, electronic transformers, and electromagnetic transformers.

For example, one Master Dimmer can control a Slave Dimmer with LED lamps and at the same time a second Slave Dimmer with halogen lamps, and a third with electronic transformers.

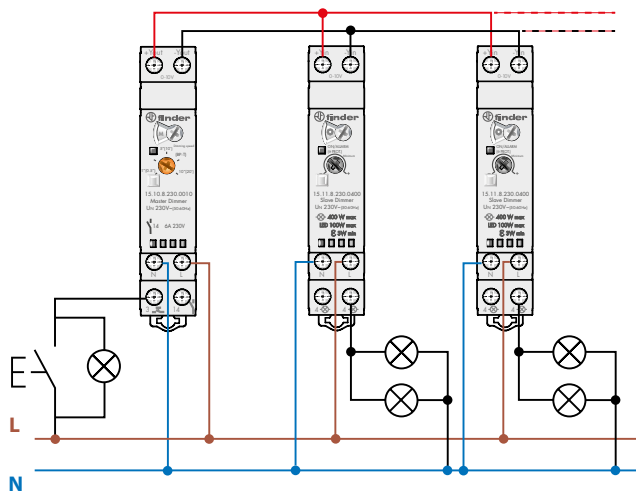

MASTER DIMMER TYPE 15.10 AND SLAVE DIMMER TYPE 15.11

It is recommended that the Master controls from one to a maximum of 32 Slave units.

The push-buttons (including illuminated push-buttons Max. 15) serve as the ON / OFF (momentary push), or when pressed for a longer time they adjust the brightness level.

Each Slave can drive a different load type.

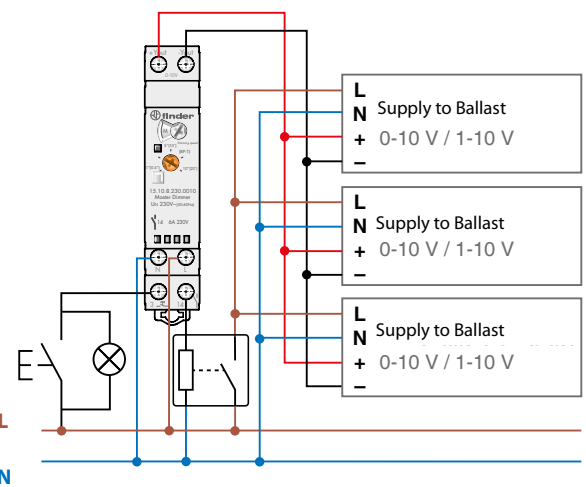

MASTER DIMMER + 0 - 10 V ELECTRONIC TRANSFORMER OR BALLAST

Using only the Master Dimmer it is possible to control electronic transformers or ballasts with a 0 - 10 V / 1 - 10 V input (observing correct polarity).

For 1 - 10 V applications it is suggested to supply the Ballast Live from terminal 14. This will ensure that the supply to the Ballast is cut-off for a signal < 1 V.

Note: Check that the maximum Peak Current of the Ballast does not exceed the 30 A 230 V AC rating of terminal 14. Use a contactor or power relay to switch loads exceeding this value.

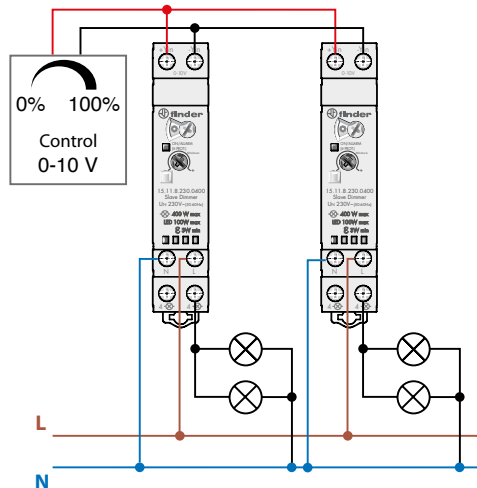

BMS 0 - 10 V OUTPUTS + SLAVE DIMMERS

In the case of Home Automation or Building Automation systems you can use just the Slave Dimmer Type 15.11 directly controlled by the 0 - 10 V output of the building management system (BMS), or by 0 - 10 V rotary regulators.

Wiring diagrams - Types 15.51, 15.81 and 15.91

Note: remember to maintain a ground/earth connection for class 1 light fittings.

Type 15.51 - 3 wire connection

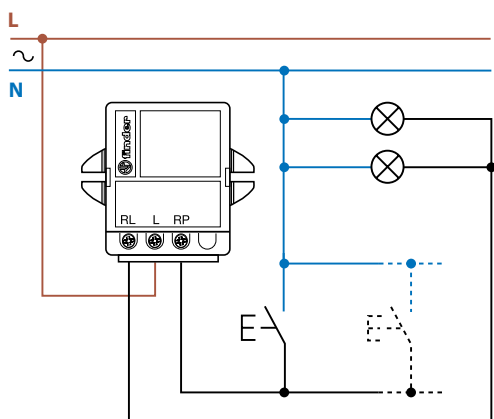

Type 15.51 - 4 wire connection

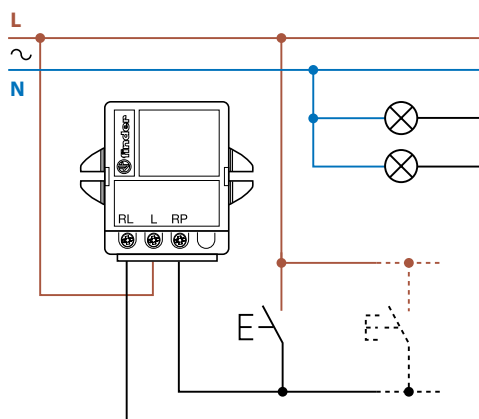

Type 15.91 - 3 wire connection

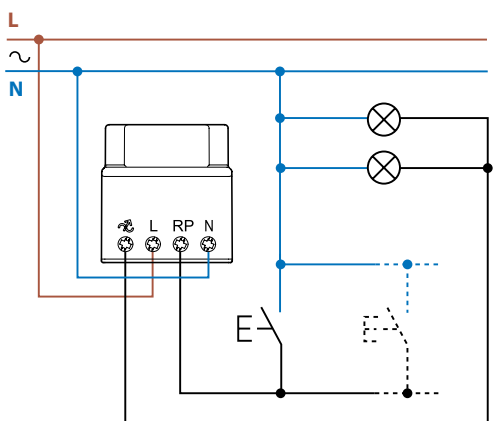

Type 15.91 - 4 wire connection

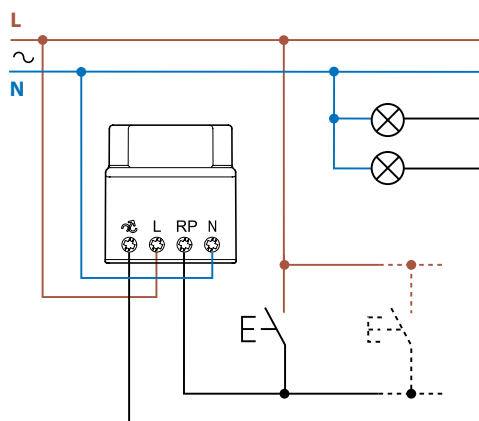

Type 15.81 - 3 wire connection

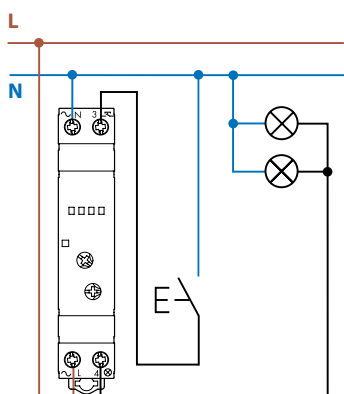

Type 15.81 - 4 wire connection

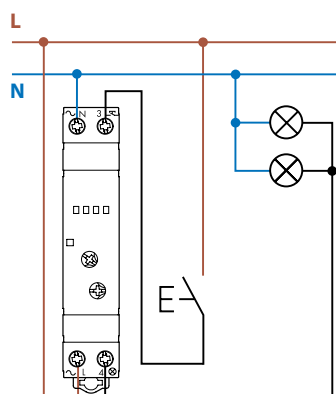

Outline drawings

15.51
Screw terminal

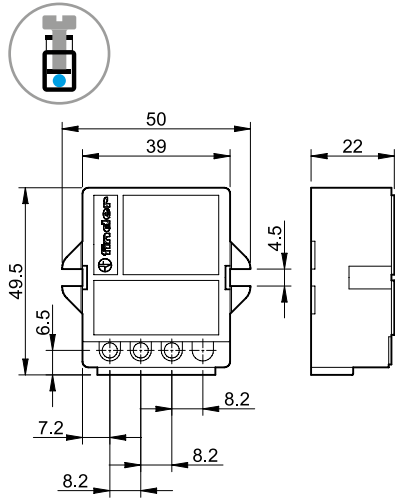

15.91
Screw terminal

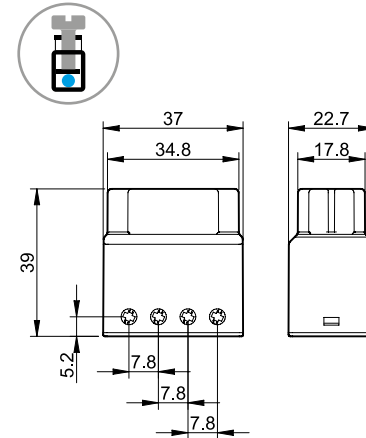

15.10
Screw terminal

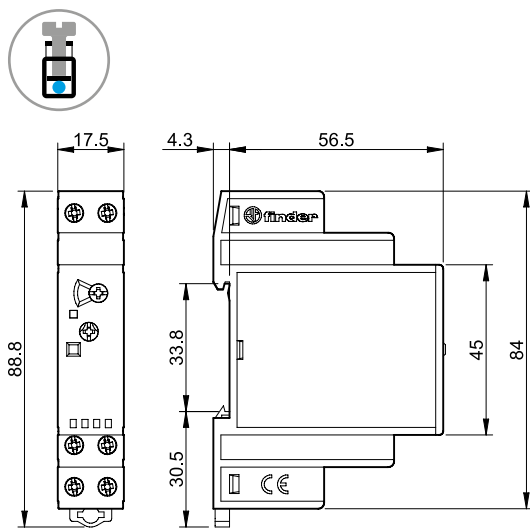

15.11
Screw terminal

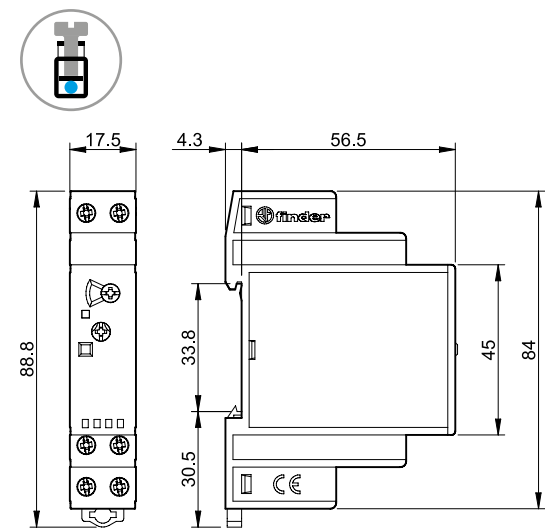

15.81
Screw terminal

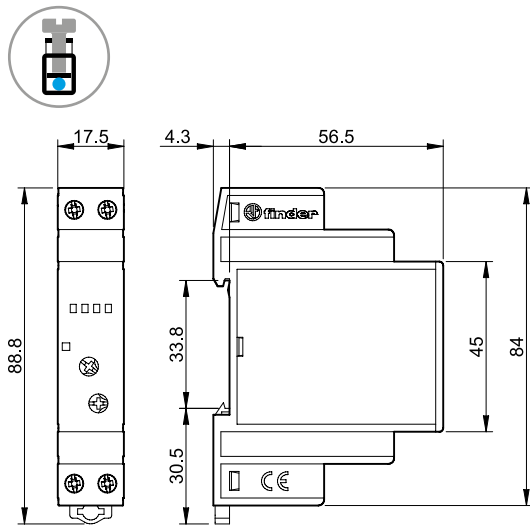

Accessories



020.01

Adaptor for panel mounting for types 15.10, 15.11 and 15.81, plastic, 17.5 mm wide

020.01

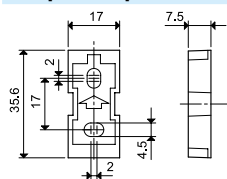

022.09

Separator for rail mounting, plastic, 9 mm wide for types 15.10, 15.11 and 15.81

022.09

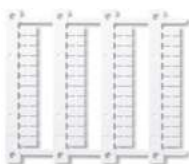
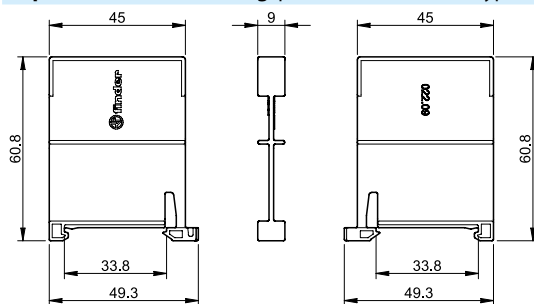

060.48

Sheet of marker tags for types 15.10, 15.11 and 15.81, plastic, 48 tags, 6 x 12 mm

060.48



022.18



8-way jumper link for type 15.10 and 15.11 connection, 17.5 mm wide

022.18 (blue)

Rated values

10 A - 250 V

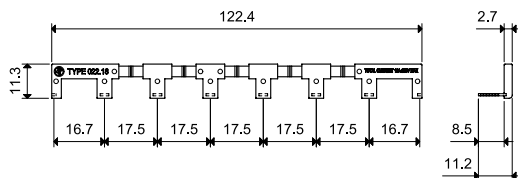



finder[®]
SWITCH TO THE FUTURE

PIR movement and presence detectors 10 A



Hotel room energy-enabling units



Lighting control in corridors (for hotels, offices and hospitals)



Offices, swimming baths and schools



Staircase light control

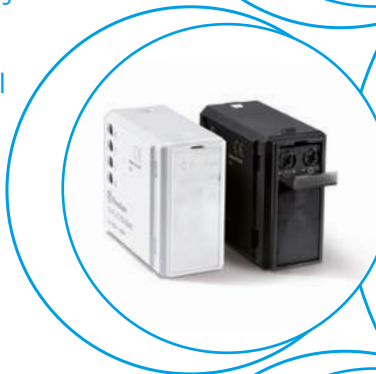

18
SERIES



PIR movement detectors for internal or external installations - wall mounting

Type 18.01

- Internal installation
- Surface mounting

Type 18.11

- External installation (IP54)
- Surface mounting

Type 18.A1

- External mounting (IP55)
- Terminal for PE connection
- Push-in terminals

- Output contact connected to supply live
- Small size
- Adjustable ambient light intervention threshold
- Adjustable Light ON Time
- Universal mounting position - permits the selection of any area for survey
- Wide angle of survey

18.01/18.11
Screw terminal



18.A1
Push-in terminal



NOTE: with 110...125 V AC supply, the Ratings (AC1, AC15 and lamp loads) must be reduced by 50 % (e.g. 500 W instead of 1000 W)

For outline drawings see page 17

Contact specification

	18.01	18.11	18.A1
Number of contacts	1 NO (SPST-NO)	1 NO (SPST-NO)	1 NO (SPST-NO)
Rated current/Maximum peak current	A 10/20 (100 A - 5 ms)	A 10/20 (100 A - 5 ms)	A 10/20 (100 A - 5 ms)
Rated voltage/Maximum switching voltage	V AC 230/230	V AC 230/230	V AC 230/230
Rated load AC1	VA 2300	VA 2300	VA 2300
Rated load AC15	(230 V) VA 450	(230 V) VA 450	(230 V) VA 450
Nominal lamp rating 230 V:			
incandescent/halogen W	1000	1000	1000
fluorescent lamp with electronic ballast W	500	500	500
fluorescent lamp with electromechanical ballast W	350	350	350
CFL W	300	300	300
LED 230 V W	300	300	300
halogen or LV LED with electronic ballast W	300	300	300
halogen or LV LED with electromechanical ballast W	500	500	500
Standard contact material	AgSnO ₂	AgSnO ₂	AgSnO ₂

Supply specification

	18.01	18.11	18.A1
Coil specification	V AC (50/60 Hz) 120...230	V AC (50/60 Hz) 120...230	V AC (50/60 Hz) 110...230
	DC —	DC —	DC —
Rated power AC/DC	VA (50 Hz)/W 2.5/—	VA (50 Hz)/W 2.5/—	VA (50 Hz)/W 2/0.8
Operating range	V AC (50/60 Hz) 96...253	V AC (50/60 Hz) 96...253	V AC (50/60 Hz) 96...253
	DC —	DC —	DC —

Technical data

	18.01	18.11	18.A1
Electrical life at rated load AC1	cycles 100 · 10 ³	cycles 100 · 10 ³	cycles 100 · 10 ³
Ambient light intervention threshold	lx 5...350	lx 5...350	lx 5...1000
Light ON time after last detection	10 s...12 min	10 s...12 min	10 s...20 min
Sensing area diameter	See diagram page 15	See diagram page 15	See diagram page 15
Ambient temperature range	°C -10...+50	°C -30...+50	°C -30...+50
Protection category	IP 40	IP 54	IP 55

Approvals (according to type)



- 1 NO 10 A
- Internal installations



- 1 NO 10 A
- External installations
- Protection category IP 54



- 1 NO 10 A
- External installations
- Protection category IP 55
- PE terminal
- Push-in terminals

PIR movement detectors for internal installations - ceiling mount
Type 18.21

- Surface mounting

Type 18.31

- Recess mounting

Type 18.31-0031

- High ceiling type (6 meter max.)
- Surface or recess mounting
- Output contact connected to supply live
- Small size
- Adjustable ambient light intervention threshold
- Adjustable Light ON Time
- Wide angle of survey

18.21/18.31/18.31...0031

Screw terminal



NOTE: with 110...125 V AC supply, the Ratings (AC1, AC15 and lamp loads) must be reduced by 50 % (e.g. 500 W instead of 1000 W)

For outline drawings see page 16

Contact specification

Number of contacts		1 NO (SPST-NO)	1 NO (SPST-NO)	1 NO (SPST-NO)
Rated current/Maximum peak current	A	10/20 (100 A - 5 ms)	10/20 (100 A - 5 ms)	10/20 (100 A - 5 ms)
Rated voltage/Maximum switching voltage	V AC	230/230	230/230	230/230
Rated load AC1	VA	2300	2300	2300
Rated load AC15	(230 V) VA	450	450	450
Nominal lamp rating 230 V:				
incandescent/halogen W		1000	1000	1000
fluorescent lamp with electronic ballast W		500	500	500
fluorescent lamp with electromechanical ballast W		350	350	350
CFL W		300	300	300
LED 230 V W		300	300	300
halogen or LV LED with electronic ballast W		300	300	300
halogen or LV LED with electromechanical ballast W		500	500	500
Standard contact material		AgSnO ₂	AgSnO ₂	AgSnO ₂

Supply specification

Coil specification	V AC (50/60 Hz)	120...230	120...230	120...230
	DC	—	—	—
Rated power AC/DC	VA (50 Hz)/W	2/1	2/1	2/1
Operating range	V AC (50/60 Hz)	96...253	96...253	96...253
	DC	—	—	—

Technical data

Electrical life at rated load AC1	cycles	100 · 10 ³	100 · 10 ³	100 · 10 ³
Ambient light intervention threshold	lx	5...350	5...350	5...350
Light ON time after last detection		10 s...12 min	10 s...12 min	30 s...35 min
Sensing area diameter		See diagram page 15	See diagram page 15	See diagram page 15
Ambient temperature range	°C	-10...+50	-10...+50	-10...+50
Protection category		IP 40	IP 40	IP 40

Approvals (according to type)

- 1 NO 10 A
- Surface mounting



- 1 NO 10 A
- Recess mounting



- 1 NO 10 A
- High ceiling applications (up to 6 meters)
- Light ON time after last detection (30 s...35 min)



PIR movement detectors for internal installations, with volt-free output contact

Type 18.21-0300

- Surface mounting

Type 18.31-0300

- Recess mounting

- Applications where interface to PLC or BMS is required
- Ceiling mounting
- Small size
- Adjustable ambient light intervention threshold
- Adjustable Light ON Time
- Wide angle of survey

18.21...0300/18.31...0300
Screw terminal



NOTE: with 110...125 V AC supply, the Ratings (AC1, AC15 and lamp loads) must be reduced by 50 % (e.g. 500 W instead of 1000 W)

For outline drawings see page 16

Contact specification

Number of contacts		1 NO (SPST-NO)	1 NO (SPST-NO)
Rated current/Maximum peak current	A	10/20 (100 A - 5 ms)	10/20 (100 A - 5 ms)
Rated voltage/Maximum switching voltage	V AC	250/400	250/400
Rated load AC1	VA	2500	2500
Rated load AC15	(230 V) VA	450	450
Nominal lamp rating 230 V:			
incandescent/halogen W		1000	1000
fluorescent lamp with electronic ballast W		500	500
fluorescent lamp with electromechanical ballast W		350	350
CFL W		300	300
LED 230 V W		300	300
halogen or LV LED with electronic ballast W		300	300
halogen or LV LED with electromechanical ballast W		500	500
Standard contact material		AgSnO ₂	AgSnO ₂

Supply specification

Coil specification	V AC (50/60 Hz)	120...230	120...230
	V AC (50/60 Hz)/DC	24	24
Rated power AC/DC	VA (50 Hz)/W	2/1	2/1
Operating range	V AC (50/60 Hz)	96...253	96...253
	V AC (50/60 Hz)/DC	19.2...26.4	19.2...26.4

Technical data

Electrical life at rated load AC1	cycles	100 · 10 ³	100 · 10 ³
Ambient light intervention threshold	lx	5...350	5...350
Light ON time after last detection		10 s...12 min	10 s...12 min
Sensing area diameter		See diagram page 15	See diagram page 15
Ambient temperature range	°C	-10...+50	-10...+50
Protection category		IP 40	IP 40

Approvals (according to type)



18.21-0300



- 1 NO 10 A
- Surface mounting

18.31-0300



- 1 NO 10 A
- Recess mounting

Movement and presence detectors with Push-in terminals For internal installation
Type 18.51

- Standard version
- Volt-free output contact

Type 18.51-0040

- Possibility to connect external push-button to force the output state
- Dynamic light compensation
- Output contact connected to supply live

Type 18.51-B300

- Programmable via Bluetooth LE (Low Energy) using Android and iOS smartphones
- Extensive sensing area up to 64 m²
- Two sensing areas: "presence" suitable for zones of low activity, and "movement" suitable for transit areas or zones of high activity
- Modern design
- Quick installation thanks to push-in terminals
- 1 NO contact 10 A, with "zero crossing" switching
- Wall mounting compatible with 60 mm box and 2 or 3 module box
- Double terminals for easy "looping" in and out

18.51/18.51...0040/18.51...B300

Push-in terminal



NOTE: with 110...125 V AC supply, the Ratings (AC1, AC15 and lamp loads) must be reduced by 50 % (e.g. 500 W instead of 1000 W)

For outline drawings see page 16

Contact specification

		18.51	18.51...0040	18.51...B300
Number of contacts		1 NO (SPST-NO)	1 NO (SPST-NO)	1 NO (SPST-NO)
Rated current/Maximum peak current	A	10/20 (100 A - 5 ms)	10/20 (100 A - 5 ms)	10/20 (100 A - 5 ms)
Rated voltage/Maximum switching voltage	V AC	250/400	230/230	230/230
Rated load AC1	VA	2500	2300	2300
Rated load AC15	(230 V) VA	450	450	450
Nominal lamp rating 230V:				
incandescent/halogen W		1000	1000	1000
fluorescent lamp with electronic ballast W		500	500	500
fluorescent lamp with electromechanical ballast W		350	350	350
CFL W		300	300	300
LED 230 V W		300	300	300
halogen or LV LED with electronic ballast W		300	300	300
halogen or LV LED with electromechanical ballast W		500	500	500
Standard contact material		AgSnO ₂	AgSnO ₂	AgSnO ₂

Supply specification

		18.51	18.51...0040	18.51...B300
Coil specification	V AC (50/60 Hz)	110...230	110...230	110...230
Rated power	VA (50 Hz)/W	1.5/1	1.5/1	1.5/1
Operating range	V AC (50/60 Hz)	96...253	96...253	96...253

Technical data

		18.51	18.51...0040	18.51...B300
Electrical life at rated load AC1	cycles	100 · 10 ³	100 · 10 ³	100 · 10 ³
Ambient light intervention threshold	lx	1...500	1...500	4...1000
Light ON time after last detection		12 s...35 min	12 s...35 min	12 s...25 min
Sensing area diameter		See diagram page 15	See diagram page 15	See diagram page 15
Ambient temperature range	°C	-10...+50	-10...+50	-10...+50
Protection category		IP 40	IP 40	IP 40

Approvals (according to type)

18.51

- 1 NO 10 A (volt-free)
- Sensing area 360°

NEW 18.51...0040

- 1 NO 10 A (connected to supply live)
- Sensing area 360°
- External push-button connection
- Dynamic Light Compensation

NEW 18.51...B300

- 1 NO 10 A (volt-free)
- Sensing area 360°

Movement and presence detectors with Push-in terminals. For internal installation.

Type 18.5D with DALI interface

Three selectable functions:

- Daylight-linked constant light level control
- ON/OFF control with early warning
- ON/OFF control with early warning + courtesy light level

Type 18.5K with KNX interface

- 2 outputs (data telegrams) for load control (Lighting, HVAC etc.)
- 1 output (data telegram) – movement/ presence detected
- Adjustment of ambient light threshold, and PIR sensitivity
- Master/Slave mode for increased sensing area
- Selectable function to inhibit ambient light threshold control
- Reporting of light level and movement status (for security purposes, etc.)

18.5D
Push-in terminal



For outline drawings see page 16

Supply specification		18.5D	18.5K
Coil specification	V AC (50/60 Hz)	110...230	—
Rated power	VA (50 Hz)/W	1.5/1	—
Operating range	V AC (50/60 Hz)	96...253	—
Supply specification			
Type of BUS		—	KNX
Supply voltage	V DC	—	30
Rated consumption	mA	—	10
Technical data			
Ambient light intervention threshold	lx	10...500	1...1500
Light ON time after last detection		10 s...35 min	0.1 s...18 h
Ambient temperature range	°C	-10...+50	-5...+45
Protection category		IP 40	IP 40
Approvals (according to type)		CE	CE



- Applications: offices, schools, zones of low activity
- Suitable for direct control of up to 8 DALI lighting ballasts
- Extensive sensing area up to 64 m²
- Two sensing areas: "presence" suitable for zones of low activity, and "movement" suitable for transit areas or zones of high activity



- Applications: offices, schools, zones of low activity
- Extensive sensing area up to 64 m²
- Two sensing areas: "presence" suitable for zones of low activity, and "movement" suitable for transit areas or zones of high activity

Movement detectors with Push-in terminals
For internal installation - with volt-free output contact
Type 18.41

- Corridor (ceiling) installation

Type 18.61

- Wall mount installation

- Extensive sensing area up to 120 m²
- Modern design
- Quick installation thanks to push-in terminals
- 1 NO contact 10 A, with "zero crossing" switching
- Wall mounting compatible with 60 mm box and 2 or 3 module box
- Double terminals for easy "looping" in and out

18.41/18.61

Push-in terminal



NOTE: with 110...125 V AC supply, the Ratings (AC1, AC15 and lamp loads) must be reduced by 50 % (e.g. 500 W instead of 1000 W)

For outline drawings see page 16

Contact specification

		18.41	18.61
Number of contacts		1 NO (SPST-NO)	1 NO (SPST-NO)
Rated current/Maximum peak current	A	10/20 (100 A - 5 ms)	10/20 (100 A - 5 ms)
Rated voltage/ Maximum switching voltage	V AC	250/400	250/400
Rated load AC1	VA	2500	2500
Rated load AC15	VA	450	450
Nominal lamp rating 230 V:			
	incandescent/halogen W	1000	1000
	fluorescent lamp with electronic ballast W	500	500
	fluorescent lamp with electromechanical ballast W	350	350
	CFL W	300	300
	LED 230 V W	300	300
	halogen or LV LED with electronic ballast W	300	300
	halogen or LV LED with electromechanical ballast W	500	500
Standard contact material		AgSnO ₂	AgSnO ₂

Supply specification

		18.41	18.61
Coil specification	V AC (50/60 Hz)	110...230	110...230
Rated power	VA (50 Hz)/W	1.5/1	1.5/1
Operating range	V AC (50/60 Hz)	96...253	96...253

Technical data

		18.41	18.61
Electrical life at rated load AC1	cycles	100 · 10 ³	100 · 10 ³
Ambient light intervention threshold	lx	1...500	1...500
Light ON time after last detection		12 s...35 min	12 s...35 min
Sensing area diameter		See diagram page 15	See diagram page 15
Ambient temperature range	°C	-10...+50	-10...+50
Protection category		IP 40	IP 40

Approvals (according to type)

18.41

- 1 NO 10 A
- Applications: hotel and offices corridors, transit areas
- Sensing area 30 meters length and 4 meters width

18.61

- 1 NO 10 A
- Specifically for wall mounting
- Wide angle: 180°
- Wall mounting compatible with 60 mm box

Movement detectors for internal installation

Type 18.91

- Wall mount installation
- External push-button connection
- Modern design
- 1 output with “zero crossing” switching
- Wall mounting compatible with 3 module housing, complete with adaptor for following frames:
 - BTicino series Axolute
 - BTicino series Light tech
 - BTicino series Living
 - BTicino series Living light Air
 - BTicino series Matix
 - Gewiss series Chorus
 - Vimar series Eikon
 - Vimar series Idea
 - Vimar series Arkè
 - Vimar PLANA
- White or black color version

18.91 **NEW**



- Specifically for wall mounting
- Wide angle: 110°
- Applications: corridors, transit areas, toilets, staircases

18.91
Screw terminal



For outline drawings see page 16

Output data		
Rated voltage	V AC	230
Power max.	W	200
Power min.	W	3
Nominal lamp rating 230 V:		
incandescent/halogen W		200
toroidal electromagnetic transformers for LV halogen W		200
E-core electromagnetic transformers for LV halogen W		200
electronic transformers (ballasts) for LV halogen W		200
compact fluorescent (CFL) W		200
230 V LED W		200
electronic transformers for LV LED W		200
Supply specification		
Nominal voltage (U _N)	V AC (50/60 Hz)	230
Rated power	VA(50Hz)/W	14/0.5
Operating range		(0.8...1.1)U _N
Technical data		
Ambient light intervention threshold	lx	5...500 (black)/6...600 (white)
Light ON time after last detection		10 s...20 min
Sensing area		See diagram page 15
Ambient temperature range	°C	-10...+50
Protection category		IP 20
Approvals (according to type)		CE

Ordering information

Example: 18 series, PIR movement detector for internal installations, wall mounting, 1 NO 10 A contact, 120...230 V AC supply.

1 8 . 0 1 . 8 . 2 3 0 . 0 0 0 0 0

Series

Type

- 0 = Internal installation - wall mounting
- 1 = External installations
- 2 = Internal ceiling installation - surface mounting
- 3 = Internal ceiling installation - recessed mounting
- 4 = PIR movement detector for corridors
- 5 = PIR movement and presence detector
- 6 = PIR movement detector wall mounting
- 9 = PIR movement detector wall mounting residential switch boxes
- A = External installations IP 55, push-in terminals

Program

- 0 = Standard
- B = Bluetooth programming

Contact circuit

- 0 = Voltage output
- 3 = Volt-free output contact

Supply voltage

- 024 = 24 V AC/DC for types 18.21/31-0300 only
- 030 = KNX Bus
- 230 = 120...230 V for types 18.01, 18.11, 18.21, 18.31
- 230 = 110...230 V for types 18.A1, 18.41, 18.51, 18.51.B300, 18.61, 18.5D
- 230 = 230 V for type 18.91

Supply version

- 0 = AC (50/60 Hz)/DC (24 V only)
- 8 = AC (50/60 Hz)
- 9 = DC

No. of poles/Output

- 1 = Single pole switching 1 NO (SPST-NO), 10 A
- D = PIR movement and presence detector with DALI interface
- K = PIR movement and presence detector with KNX interface

Special version

- 31 = High ceilings, (30 s...35 min)
- 40 = Push-button connection (only 18.51)
- 40 = Push-button connection, white color (only 18.91)
- 42 = Push-button connection, black color (only 18.91)

Codes

18.01.8.230.0000	18.31.0.024.0300	18.41.8.230.0300
18.11.8.230.0000	18.31.8.230.0000	18.51.8.230.0300
18.21.0.024.0300	18.31.8.230.0300	18.51.8.230.0040
18.21.8.230.0000	18.31.8.230.0031	18.51.8.230.B300
18.21.8.230.0300		18.61.8.230.0300
		18.91.8.230.0040
		18.91.8.230.0042
		18.A1.8.230.0000
		18.5D.8.230.0000
		18.5K.9.030.0000

Technical data

Insulation					
Dielectric strength between open contacts	V AC	1000 (except for type 18.91 TRIAC output)			
Between supply and contact	V AC	1500 (types 18.21...0300, 18.31...0300, 18.41, 18.51, 18.61)			
EMC specifications					
Type of test	Reference standard				
Electrostatic discharge	contact discharge	EN 61000-4-2	4 kV		
	air discharge	EN 61000-4-2	8 kV		
Radiated electromagnetic field (80...2000 MHz)		EN 61000-4-3	3 V/m		
Fast transients (burst 5/50 ns, 5 and 100 kHz)	on supply terminals	EN 61000-4-4	1 kV		
Voltage pulses on supply terminals (surge 1.2/50 µs)	common mode	EN 61000-4-5	4 kV (2 kV for 18.91)		
	differential mode	EN 61000-4-5	4 kV (2.5 kV for 18.01/11, 1 kV for 18.91)		
Radiofrequency common mode voltage (0.15...230 MHz)	on supply terminals	EN 61000-4-6	3 V		
Voltage dips	70% U _N , 40% U _N	EN 61000-4-11	10 cycles		
Short interruptions		EN 61000-4-11	10 cycles		
Radiofrequency conducted emissions	(0.15...30)MHz	EN 55014	class B		
Radiated emissions	(30...1000)MHz	EN 55014	class B		
Terminals			18.01, 18.11, 18.21, 18.31, 18.91		18.41, 18.51, 18.51...B300, 18.61, 18.A1
Type			Screw terminal		Push-in (see pag. 18)
Screw torque	Nm	0.5		—	
Max. wire size		solid cable	stranded cable	solid cable	stranded cable
	mm ²	1 x 6 / 2 x 4	1 x 4 / 2 x 2.5	2.5	2.5
	AWG	1 x 10 / 2 x 12	1 x 12 / 2 x 14	14	14
Wire strip length	mm	9	9	8	8
Other data					
Power lost to the environment	without output current	W	0.3		
	with rated output current	W	1.4		

- Following the initial power-on, and power-on following a power interruption, the detector makes a hardware-software initialisation for approximately 30 seconds. However, the behavior of the output during this 30 seconds will depend on certain circumstances:
 - If the detector was in the On state before the power interruption, and if the lighting level is (currently) below the pre-set threshold, then the output contact will immediately close when the power is re-applied, for the time delay set by the potentiometer (irrespective of whether movement is being detected).
 - If the detector was in the Off state before the power interruption, or if the ambient light is currently over the pre-set threshold, then the detector will not switch-on until the end of the initialisation phase (assuming movement is then detected).

Wiring diagram

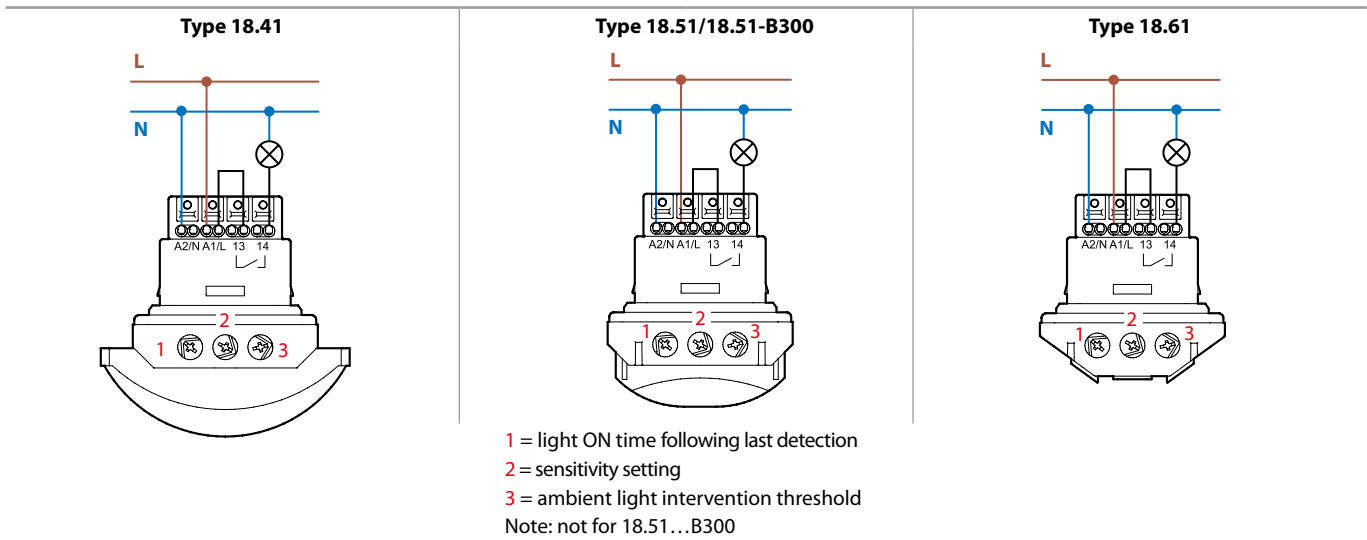
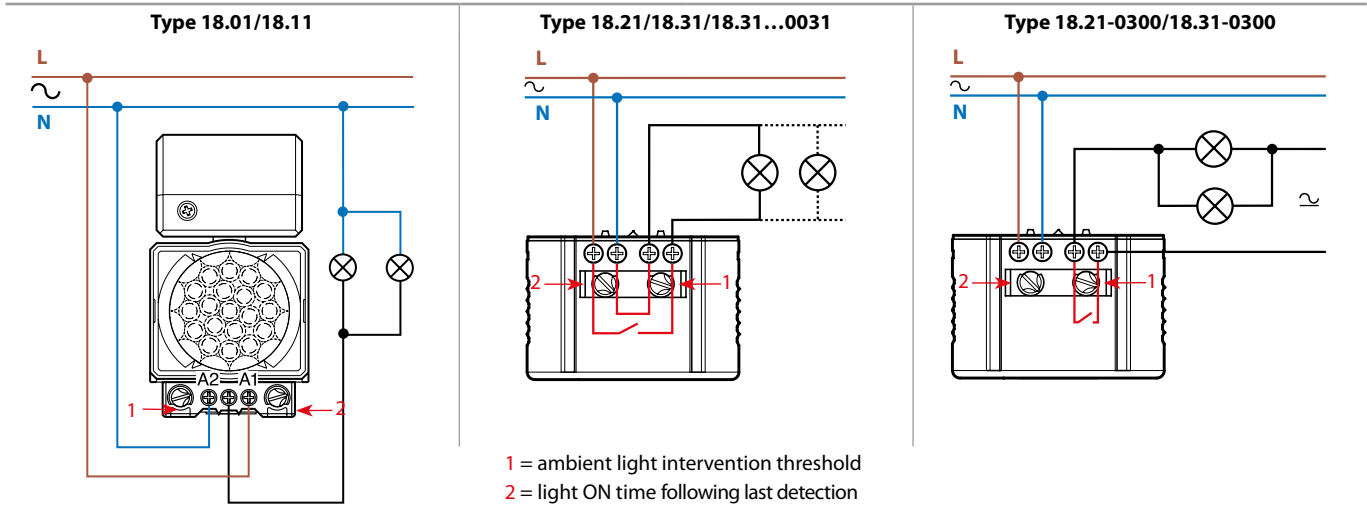

The nominal lamp rating as stated in the contact specification applies when wiring is realized in accordance with the diagrams above. If the load is powered from a phase different to that powering the Movement detector, then a 50% reduction in the lamp rating must be considered.

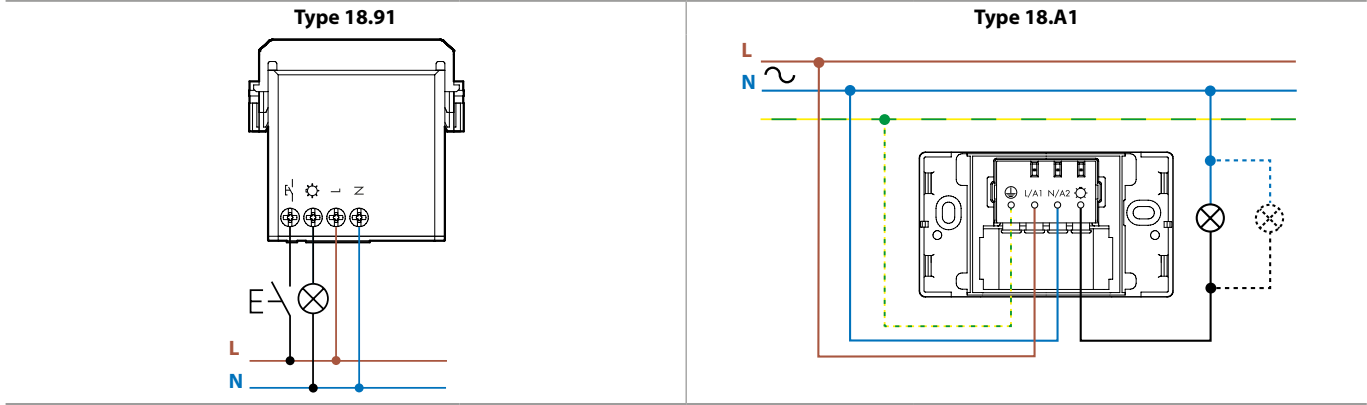
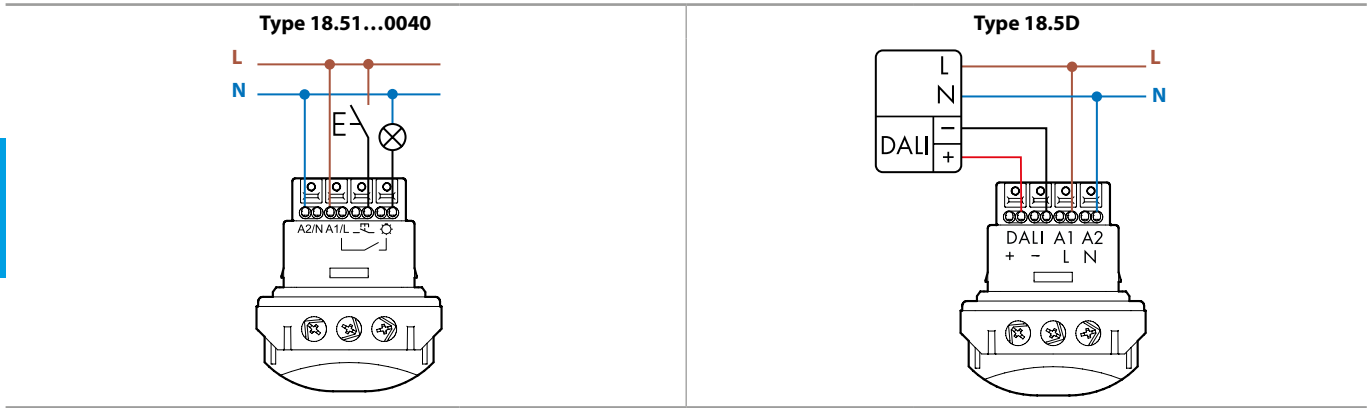

Wiring diagram

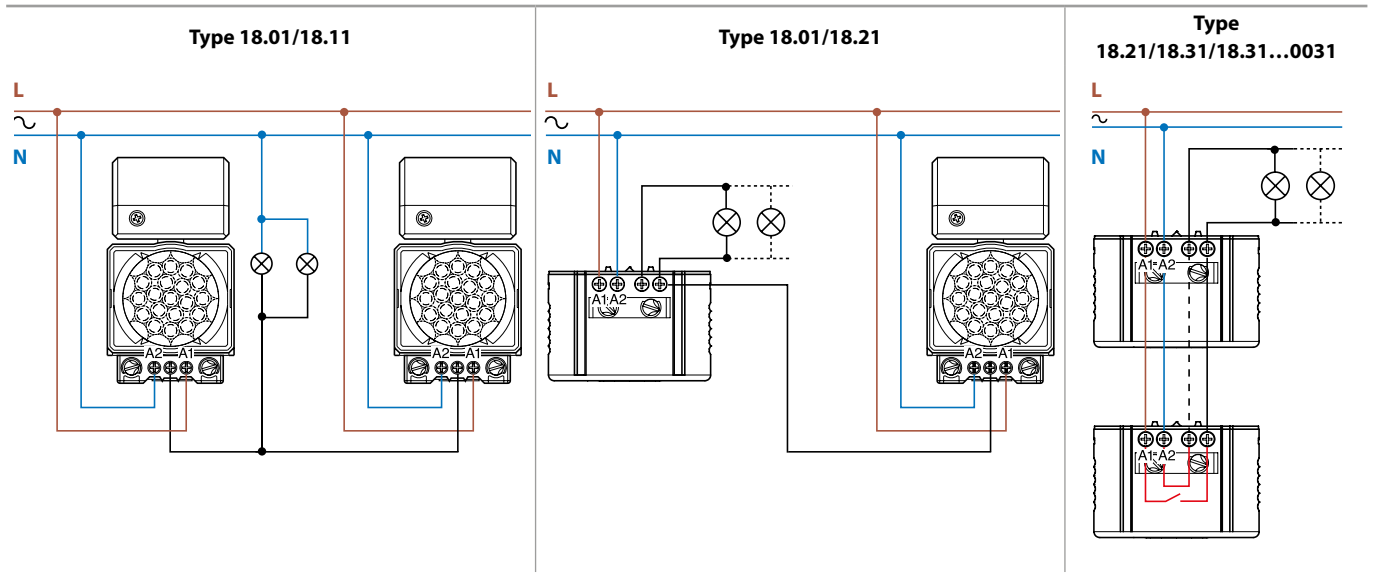

Note: Observe the polarity indicated for Phase and Neutral

Type 18.51-B300 - Bluetooth

Through the use of Bluetooth LE (Low Energy) technology programming the detector's operating characteristics can be easily and conveniently done using an Android or iOS smartphone.

After installing the 18.51, simply download the Free **App Finder Toolbox** from Google and Apple's official stores and set all the required parameters.



Android, Google Play and the Google Play logo are trademarks of Google Inc.
Apple is a trademark of Apple Inc. App Store is a service mark of Apple Inc.

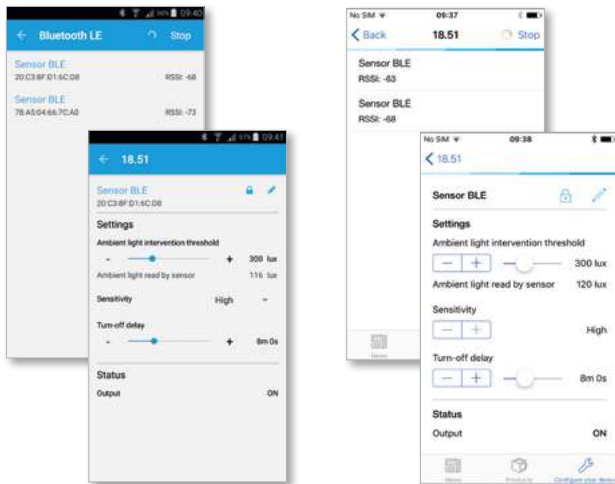

Detectors can be named and uniquely identified within a building. The ambient light level threshold can be adjusted between 4 lux and 1000 lux, the Light On delay time can be set from 12 seconds to 25 minutes, and the movement detector set to one of three sensitivity levels. When Bluetooth connection is made to a detector a red LED signals the correct pairing and that all the set parameters have been transferred. The detector then responds with two feedback values - brightness as read by the light sensor in the detector and the contact status, if closed (On) or open (Off). For security, the detectors can be locked by a selector switch and a 4-digit PIN - preventing parameter changes by unauthorized persons.

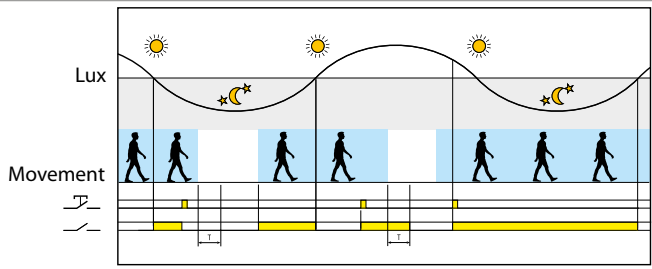
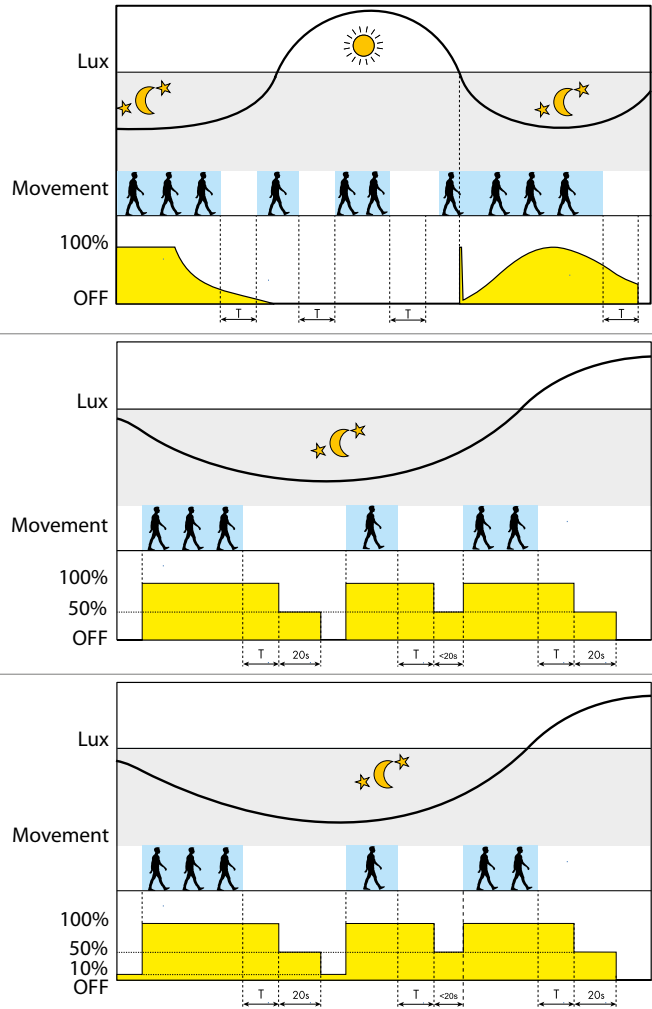
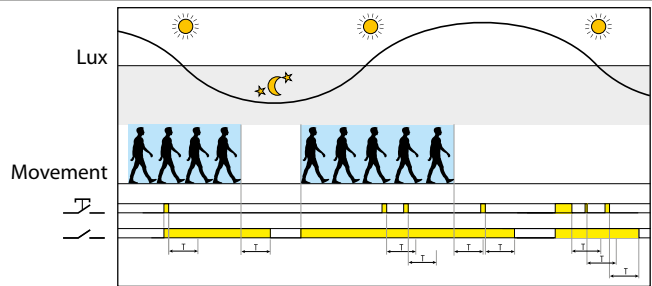

Functions

Type	Functions
18.51...0040	 <p>Push-button function A control pulse on the push-button inverts the status of the output relay, until the timing after the last movement detected is elapsed.</p> <p>Dynamic Light Compensation By incorporating Finder's Patented "light feedback compensation" principle, the 18.51...0040 is able to calculate the artificial light contributed by the lamps controlled by the output relay. In effect, this means the 18.51...0040 is able to continuously monitor the natural ambient light level, even when the output is On. As a consequence, whenever the natural light level exceeds the threshold setting the output is forced Off. This can significantly minimise the time the lighting is On, particularly where there is a high level of traffic - and cost savings can be considerable. This is an advance over other types of movement detectors, which are unable to identify the natural ambient light level when the output is On and so can only turn Off after the time delay that follows the last detected movement. In busy areas this may mean that the movement detector is being continuously re-triggered and maintained in the On state, even though the natural light level has long risen above the threshold.</p>
18.5D	 <p>Comfort - Daylight-linked constant light level control Adjusts to maintain a constant brightness level considering the detection of movement and the level of daylight - increasing or decreasing the power of the artificial light as appropriate. Suitable for small offices, classrooms or workplaces. This allows considerable energy saving while maintaining a comfortable level of illumination.</p> <p>Simplicity - ON/OFF control with early warning Works as a simple movement detector, activating the lamps at 100% power. But provides an early warning of the next shutdown with a power reduction to 50% for 20 seconds. Avoids a sudden total shutdown of lighting.</p> <p>Courtesy - ON/OFF control with early warning + courtesy light level If the brightness level is lower than the set value, artificial light is maintained at 10% power, guaranteeing a minimum level of illumination at all times. When movement is detected, the power of the lamps is raised to 100%. There is an early warning of any reduction from the 100% power level by a reduction to 50% for 20 seconds. Suitable for common areas, lobbies, corridors, elevator zones.</p>
18.91	 <p>Detection of movement Detected movement closes, or keeps closed, the output contact. Operating the push-button closes, or keeps closed, the output contact - for the set time T.</p>



Sensing area

18.01, 18.11, 18.A1 - Wall mounting

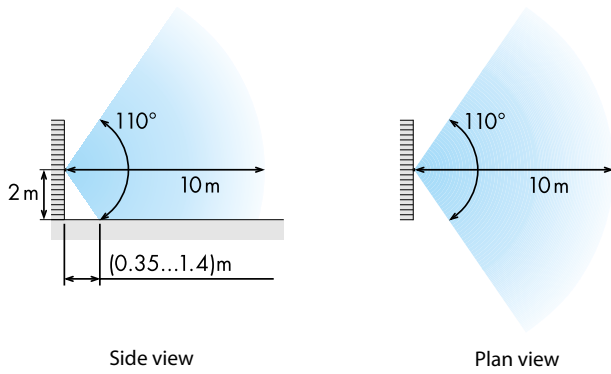

18.01, 18.11 - Ceiling mounting

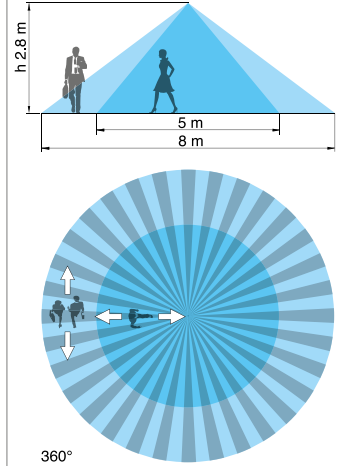

18.21, 18.31 - Ceiling mounting

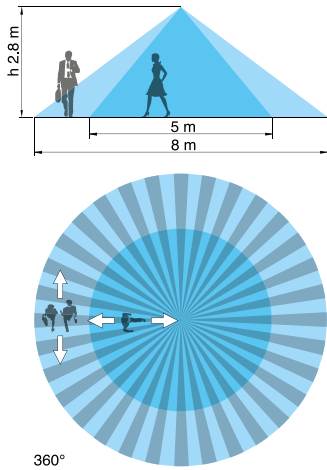

18.31...0031 - Internal ceiling installation, surface mounting

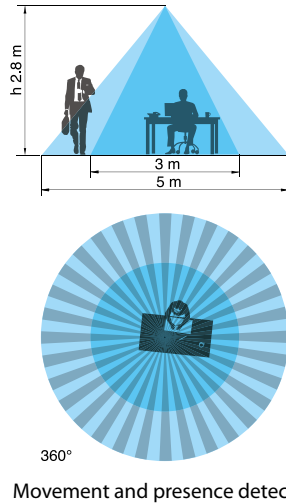

18.31...0031 - High ceilings installations

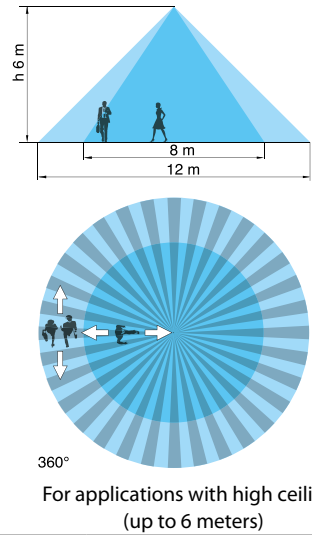

18.41

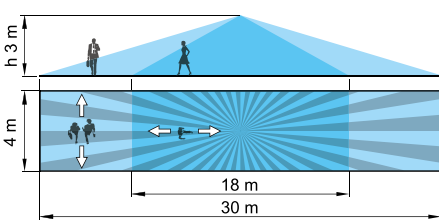

18.51/18.51...B300/18.5K

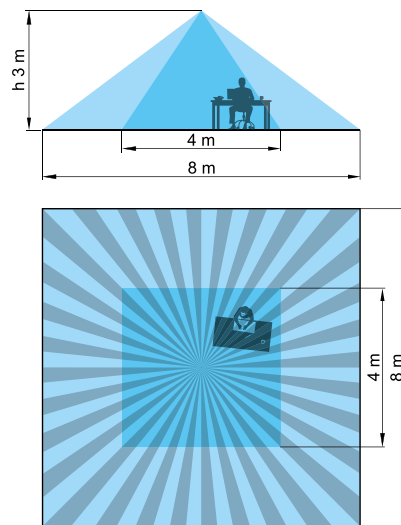

18.61

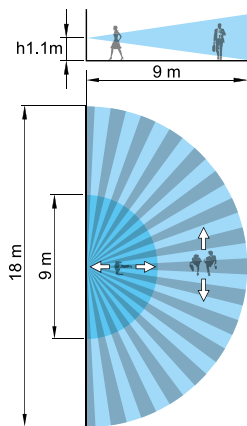

18.91

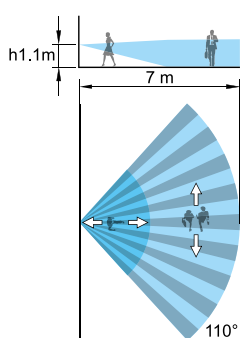

Accessories

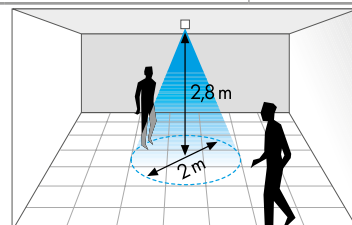

Example: 18.21/18.31 with Beam limiter

Beam limiter (supplied with the type 18.21/31/41/51)

At an installation height of 2.8 meters the area of survey will reduce at:
 18.21/18.31: diameter 2 meters
 18.41: 2.5 x 6 meters
 18.51: 2 x 2 meters



Outline drawings

Type	Suspended ceiling mounting	Recess mounting	Surface mounting
18.21			
18.31			
18.31...0031			
18.41			
18.51 18.5D 18.5K 18.51...B300			
18.61			



Outline drawings

Type 18.01

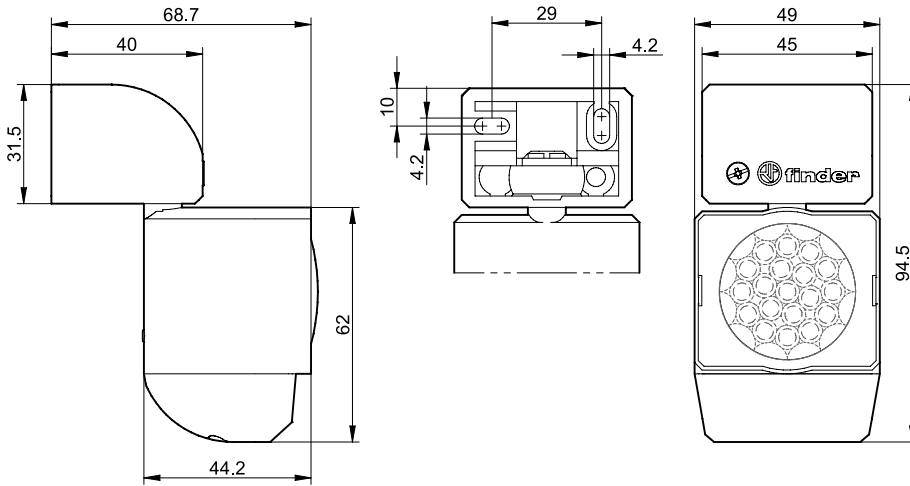

Type 18.11

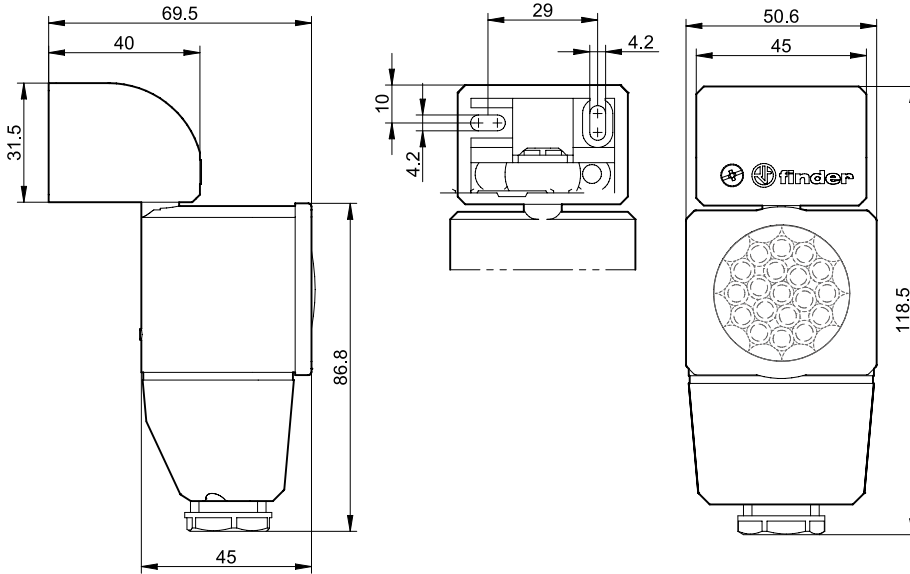

Type 18.A1

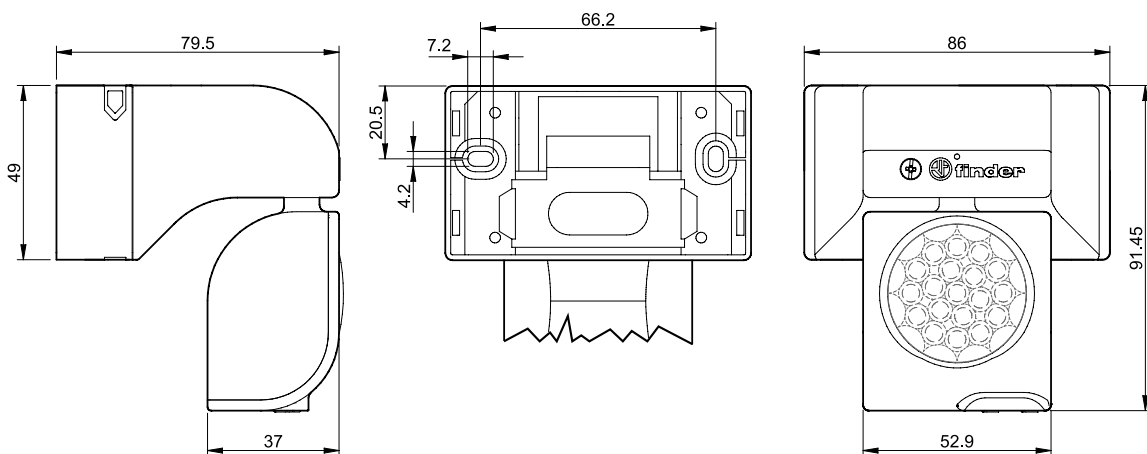

Type 18.91

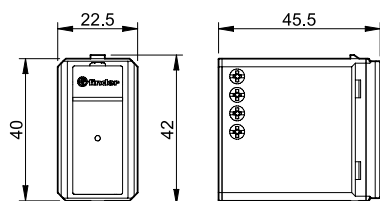

Push-in terminals for 18.41, 18.51, 18.5D, 18.61 and 18.A1

The push-in terminals permit the quick connection of solid wires or ferrules by their simple insertion into the terminal (A). It is possible to open the terminal to extract the wire by first pushing down on the push-button using a screwdriver or fingers (C). For stranded cable it is necessary first to open the terminal using the push button, both for the extraction (C) and insertion (B).

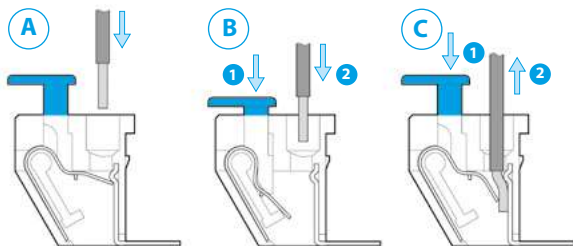

Double terminals for the easy "looping" between multiple 18 Series. The Max. wire size for each terminal is 2.5 mm².

The terminals are equipped with a test hole to take a test probe.



finder[®]
SWITCH TO THE FUTURE

Electronic step, call/reset and monostable relays



Call and reset switches for bathrooms



Bathrooms lighting control



Bedroom light control



Living room light control



Office lighting control



13
SERIES

13.81 - Electronic step relay - Rail mount - 1 Pole

**13.91 - Electronic step relay and timing step relay
Switch box mount - 1 Pole**

- Fixed time (10 minutes) timing function selectable (13.91)
- Use with 3 or 4 wire connection, with automatic recognition by the relay
- Control input can be continuously applied
- Longer mechanical and electrical life, and much quieter than electromechanical step relays
- "Zero crossing" load switching
- Can be mounted behind blanking plates, as widely used in residential wiring systems such as; BTicino: Axolute, Matix, Living and Magic, Gewiss: GW24, Vimar: Plana and Idea ... (13.91)
- 35 mm rail (EN 60715) mount (13.81)
- Cadmium free contact material

13.81/91

Screw terminals



For outline drawing see page 12

Contact specification

Contact configuration		1 NO (SPST-NO)	1 NO (SPST-NO)
Rated current/Maximum peak current	A	16/30 (120 - 5 ms)	10/20 (80 - 5 ms)
Rated voltage/ Maximum switching voltage	V AC	230/—	230/—
Rated load AC1	VA	3700	2300
Rated load AC15 (230 V AC)	VA	750	450
Nominal lamp rating:			
230 V incandescent/halogen W		3000	1000
fluorescent tubes with electronic ballast W		1500	500
fluorescent tubes with electromechanical ballast W		1000	350
CFL W		600	300
230 V LED W		600	300
LV halogen or LED with electronic ballast W		600	300
LV halogen or LED with electromechanical ballast W		1500	500
Minimum switching load	mW (V/mA)	1000 (10/10)	1000 (10/10)
Standard contact material		AgSnO ₂	AgSnO ₂

Supply specification

Nominal voltage (U _N)	V AC (50/60 Hz)	230	230
	V DC	—	—
Rated power	V A (50 Hz)/W	3/1.2	2/1
Operating range	AC (50 Hz)	(0.8...1.1)U _N	(0.8...1.1)U _N
	DC	—	—

Technical data

Electrical life at rated load in AC1	cycles	100 · 10 ³	100 · 10 ³
Maximum impulse duration		continuous	continuous
Dielectric strength between:			
open contacts V AC		1000	1000
supply - contacts V AC		—	—
Ambient temperature range	°C	-10...+60	-10...+50
Protection category		IP 20	IP 20

Approvals (according to type)



13.81



- 1 NO (SPST-NO)
- 35 mm rail (EN 60715) mount
- 17.5 mm wide

13.91



- 1 NO (SPST-NO)
- Step relay and timing step relay (10 minutes)
- For mounting within residential switch boxes

**13.01 - Electronic step/monostable relay
Rail mount - 1 Pole**
**13.61 - Multifunction step/monostable relay
with reset command - Rail mount 1 Pole**

- Selectable Step or Monostable operation (13.01)
- Multifunction (Step, Timing step, Monostable, Light ON) (13.61)
- Reset feature, for centralized off command (13.61)
- Set feature, for centralized on command (13.61.0.024)
- Control input can be continuously applied
- Longer mechanical and electrical life, and much quieter than electromechanical step relays
- 12...24 V AC/DC and 110...240 V AC supply versions (13.61)
- Suitable for SELV applications and available also for supply 12 and 24 V AC/DC (13.01)
- "Zero-crossing" load switching (13.61)
- 35 mm rail (EN 60715) mount
- Cadmium free contact material

13.01/61

Screw terminals



For outline drawing see page 12

Contact specification

Contact configuration		1 CO (SPDT)	1 CO	1 NO
Rated current/Maximum peak current	A	16/30 (120 A - 5 ms)	16/30 (120 A - 5 ms)	16/30 (120 A - 5 ms)
Rated voltage/ Maximum switching voltage	V AC	250/400	250/400	250/400
Rated load AC1	VA	4000	4000	4000
Rated load AC15 (230 V AC)	VA	750	750	750
Nominal lamp rating:				
230 V incandescent/halogen W		2000	2000	3000
fluorescent tubes with electronic ballast W		1000	1000	1500
fluorescent tubes with electromechanical ballast W		750	750	1000
CFL W		400	400	600
230 V LED W		400	400	600
LV halogen or LED with electronic ballast W		400	400	600
LV halogen or LED with electromechanical ballast W		800	800	1500
Minimum switching load	mW (V/mA)	1000 (10/10)	1000 (10/10)	1000 (10/10)
Standard contact material		AgSnO ₂	AgSnO ₂	AgSnO ₂

K Supply specification

Nominal voltage (U _N)	V AC (50/60 Hz)	110...125	230...240	—	110...240
	V DC/AC (50/60 Hz)	12	24	12...24	—
Rated power AC/DC	V A (50/60 Hz)/W	2.5/2.5	—	1/0.5	3.2/1
Operating range	V AC (50 Hz)	90...130	184...253	—	90...264
	V DC/AC (50 Hz)	10.8...13.2	20.6...33.6	10.2...26.4	—

Technical data

Electrical life at rated load in AC1	cycles	100 · 10 ³	100 · 10 ³	100 · 10 ³
Maximum impulse duration		continuous	continuous	continuous
Dielectric strength between:	open contacts V AC	1000	1000	1000
	supply - contacts V AC	4000	2000	2000
Ambient temperature range	°C	-10...+60	-10...+60	-10...+60
Protection category		IP 20	IP 20	IP 20

Approvals (according to type)

13.01

- 1 CO (SPDT)
- Step or monostable relay
- 35 mm rail (EN 60715) mount
- 35 mm wide

NEW
13.61.0.024.0000

- 1 CO (SPDT)
- Reset feature, for centralized off command
- Set feature, for centralized on command
- Multifunction:
 - step relay
 - timing step relay (30s...20min)
 - monostable relay
 - light on
- 35 mm rail (EN 60715) mount
- 17.5 mm wide

13.61.8.230.0000

- 1 NO (SPST-NO)
- Reset feature, for centralized off command
- Multifunction:
 - step relay
 - timing step relay (30s...20min)
 - monostable relay
 - light on
- 35 mm rail (EN 60715) mount
- 17.5 mm wide

- 13.11 - Call & Reset Relay - Rail mount - 1 Pole**
- 13.12 - Call & Reset Relay - Rail mount - 2 Pole**
- 13.31 - Electromechanical monostable relay
Switch box mount - 1 Pole**

- Call relay with reset command suitable for residential and commercial applications: public bathroom, hospital, hotel (type 13.11/13.12)
- Can be mounted behind blanking plates, as widely used in residential wiring systems such as; BTicino: Axolute, Matix, Living e Magic, Gewiss: GW24, Vimar: Plana e Idea ... (13.31)
- 35 mm rail (EN 60715) or flange mount (13.11 and 13.12)
- Cadmium free contact material (13.31)

13.11/12/31
Screw terminals



* During impulse only.
For outline drawing see page 12

Contact specification

		13.11	13.12	13.31
Contact configuration		1 CO (SPDT)	1 CO (SPDT) + 1 NO (SPST-NO)	1 NO (SPST-NO)
Rated current/Maximum peak current	A	12/30	8/15	12/20 (80 A - 5 ms)
Rated voltage/ Maximum switching voltage	V AC	250/400	250/400	250/400
Rated load AC1	VA	3000	2000	3000
Rated load AC15 (230 V AC)	VA	750	400	450
Nominal lamp rating:				
230 V incandescent/halogen W		1200	800	800
fluorescent tubes with electronic ballast W		500	300	400
fluorescent tubes with electromechanical ballast W		400	250	300
CFL W		300	150	200
230 V LED W		300	150	200
LV halogen or LED with electronic ballast W		300	150	200
LV halogen or LED with electromechanical ballast W		500	300	400
Minimum switching load	mW (V/mA)	500 (5/5)	300 (5/5)	1000 (10/10)
Standard contact material		AgCdO	AgCdO	AgSnO ₂
Supply specification				
Nominal voltage (U _N)	V AC (50/60 Hz)	230...240	12 - 24	12 - 230
	V DC	—	12 - 24	24
Rated power AC/DC	V A (50 Hz)/W	1.7/0.7*	3/2.5*	1/0.4
Operating range	AC (50 Hz)	(0.8...1.1)U _N	(0.8...1.1)U _N	(0.8...1.1)U _N
	DC	—	(0.8...1.1)U _N	(0.8...1.1)U _N
Technical data				
Electrical life at rated load in AC1	cycles	100 · 10 ³	100 · 10 ³	70 · 10 ³
Maximum impulse duration		10 s (100 ms minimum)	10 s (100 ms minimum)	continuous
Dielectric strength between:	open contacts V AC	1000	1000	1000
	supply - contacts V AC	2000	2000	2000
Ambient temperature range	°C	-10...+60	-10...+60	-10...+60
Protection category		IP 20	IP 20	IP 20

Approvals (according to type)



Ordering information

Example: 13 series, electronic step/monostable relay, 35 mm rail (EN 60715) mount, 1 CO (SPDT) 16 A contact, 230 V AC supply.

	1	3	.	0	1	.	8	.	2	3	0	.	A	B	C	D
Series																
Type																
0 = Step/Monostable, 35 mm rail (EN 60715) mount, 35 mm wide																
1 = Call & Reset relay, 35 mm rail (EN 60715) mount, 17.5 mm wide																
3 = Monostable relay, switch box mounting																
6 = Multifunction relay, 35 mm rail (EN 60715) mount, 17.5 mm wide																
8 = Modular step relay, 35 mm rail (EN 60715) mount, 17.5 mm wide																
9 = Step relay and timing step relay, switch box mounting																
No. of poles																
1 = 1 pole																
2 = 1 pole CO (SPDT) + 1 NO (SPST-NO)																
Supply version																
0 = AC (50/60 Hz)/DC																
8 = AC (50/60 Hz)																
9 = DC																
Supply voltage																
012 = 12 V AC/DC (13.01 and 13.12 only)																
012 = 12 V AC (13.31 only)																
024 = 24 V AC/DC (13.01 and 13.12 only)																
024 = 24 V DC (13.31 only)																
024 = 12...24 V AC/DC (13.61 only)																
125 = (110...125)V AC (13.01 only)																
230 = (230...240)V AC (13.01 and 13.11)																
230 = 110...240 V AC (13.61 only)																
230 = 230 V AC (13.31, 13.81 and 13.91)																
A: Contact material																
0 = Standard																
4 = Standard AgSnO ₂ (only for 13.31)																
B: Contact circuit																
0 = Standard																
3 = Standard NO (only for 13.31)																
Codes / Supply voltage																
13.01.0.012.0000 12 V AC/DC																
13.01.0.024.0000 24 V AC/DC																
13.01.8.125.0000 110...125 V AC																
13.01.8.230.0000 230...240 V AC																
13.11.8.230.0000 230...240 V AC																
13.12.0.012.0000 12 V AC/DC																
13.12.0.024.0000 24 V AC/DC																
13.31.8.012.4300 12 V AC																
13.31.9.024.4300 24 V DC																
13.31.8.230.4300 230 V AC																
13.61.8.230.0000 110...240 V AC																
13.61.0.024.0000 12...24 V AC/DC																
13.81.8.230.0000 230 V AC																
13.91.8.230.0000 230 V AC																

Technical data

Insulation		13.01.8	13.01.0	13.11 - 13.12	13.31 - 13.61	13.81 - 13.91		
Dielectric strength								
between control circuit and supply	V AC	4000	—	—	—	—	—	
between control circuit and contacts	V AC	4000	4000	—	—	—	—	
between R-S-A2 and contacts	V AC	—	—	2000	—	—	—	
between supply and contacts	V AC	4000	4000	—	2000	—	—	
between open contacts	V AC	1000	1000	1000	1000	1000	1000	
Other data		13.01		13.11 - 13.12	13.31	13.61	13.81	13.91
Power lost to the environment	without contact current	W	2.2	—	0.4	1	1.2	0.7
	with rated current	W	3.5	1,5	1.6	1.8	2	1.8
Max cable length for push-button connection	m	100	100	—	200	200	100	100
Max. no. of illuminated push-button	(≤1mA)	—	—	—	10*	15	12	12
Terminals		13.01		13.11 - 13.12 - 13.31 - 13.61 - 13.81 - 13.91				
Max. wire size	solid cable	stranded cable	solid cable	stranded cable				
	mm ²	1 x 6 / 2 x 4	1 x 6 / 2 x 2.5	1 x 6 / 2 x 4	1 x 4 / 2 x 2.5			
	AWG	1 x 10 / 2 x 12	1 x 10 / 2 x 14	1 x 10 / 2 x 12	1 x 12 / 2 x 14			
 Screw torque	Nm	0.8		0.8				

* For 8.230 version.

Functions

Type		
13.01		<p>Monostable On closure of a switch between terminals (B2-B3) the output contact will close, and remain so, until the switch opens.</p>
		<p>Step relay (bistable) After every impulse (B1-B2), the output contact changes state - alternately switching from open to closed and vice versa.</p>
13.11 13.12		<p>Call and Reset relay On momentary closure of the Set switch (S), the output contact closes. Only a momentary closure of the Reset switch (R) will open the output contact.</p>
13.81		<p>(RI) Step relay After every impulse, the output contact changes state - alternately switching from open to closed and vice versa.</p>
13.91		<p>(RI) Step relay After every impulse, the output contact changes state - alternately switching from open to closed and vice versa.</p>
		<p>(IT) Timing step relay On initial impulse the output contact closes and timing starts for the pre-set duration (fixed 10 min); On expiry of the time delay, the output contact opens. During the timing period it is possible to immediately open the contact with a further impulse.</p>

Operating mode setup for type 13.91

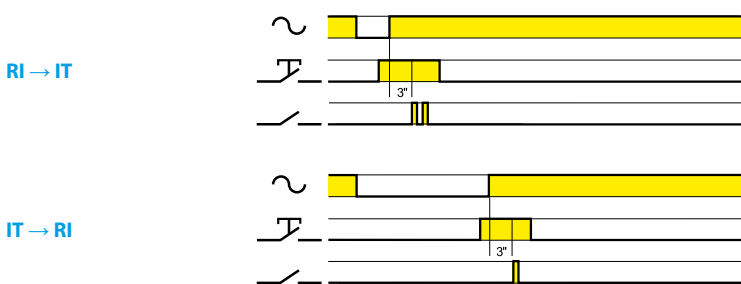

- Remove the supply voltage
- Press the control button
- Apply the supply to the relay, keeping the button closed.
After 3 second, the light will flash twice to indicate the selection of the "IT" function, or flash once for "RI" function.

Functions

Type	Functions
13.61.8.230	<p>(RM) Monostable On closure of a switch between terminal 3 and Line (or Neutral, in case of 3-wire connection) the output contact will close, and remain so, until the switch opens.</p>
	<p>(IT) Timing step relay On initial impulse the output contact closes and timing starts for the pre-set duration T; On expiry of the time delay, the output contact opens. During the timing period it is possible to immediately open the contact with a further impulse. Switch-off delay time: 30s...20min</p>
	<p>(RI) Step relay After every impulse, the output contact changes state - alternately switching from open to closed and vice versa.</p>
	<p>Light ON With this function set - the output contact stays permanently closed.</p>
13.61.0.024	<p>(RM) Monostable On closure of a switch between terminal 3 and Line (or Neutral, in case of 3-wire connection) the output contact will close, and remain so, until the switch opens.</p>
	<p>(IT) Timing step relay On initial impulse the output contact closes and timing starts for the pre-set duration T; On expiry of the time delay, the output contact opens. During the timing period it is possible to immediately open the contact with a further impulse. Switch-off delay time: 30s...20min</p>
	<p>(RI) Step relay After every impulse, the output contact changes state - alternately switching from open to closed and vice versa.</p>
	<p>Light ON With this function set - the output contact stays permanently closed.</p>

K

Wiring diagrams (13.01, 13.11, 13.12 and 13.31)

Type 13.01

Step wiring diagram

Red LED indication:
Continuous = relay ON

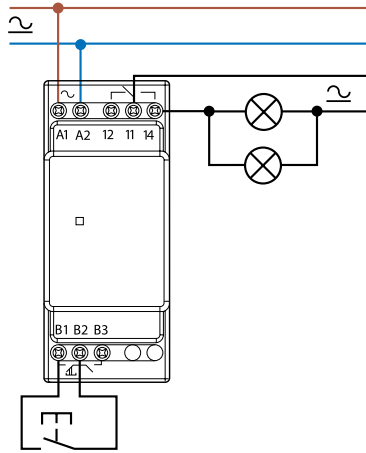

Type 13.01

Monostable wiring diagram

Red LED indication:
Continuous = relay ON

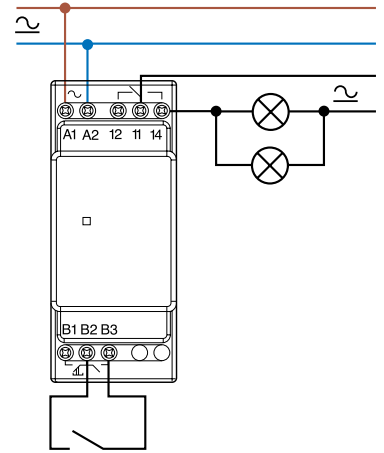

Type 13.11

Call & reset relay

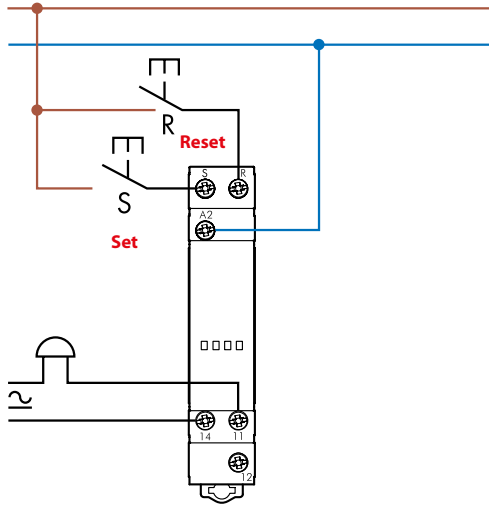

Type 13.12

Call & reset relay

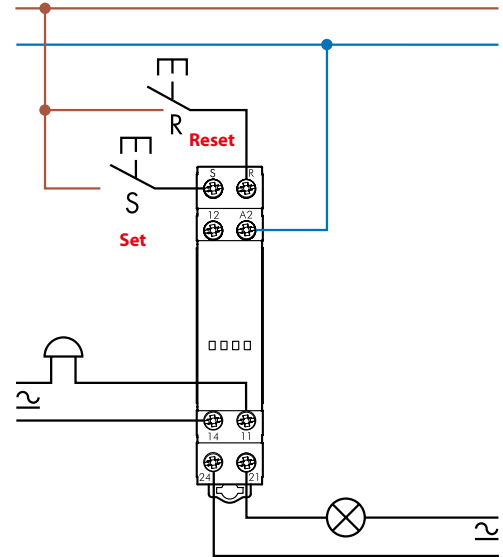

Type 13.31

Connection

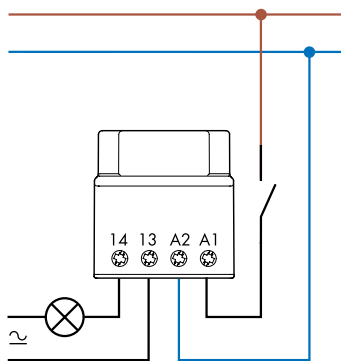

K

Wiring diagrams (13.61)

Type 13.61.8.230

3 wire connection
Red LED indication:
Continuous = relay ON
Blinking = relay OFF

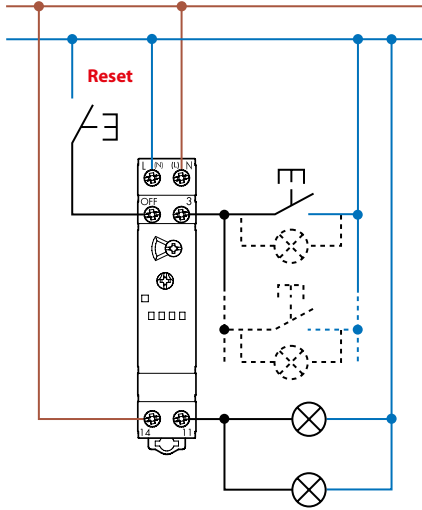

Max 10 (≤ 1 mA)
illuminated push buttons

Type 13.61.8.230

4 wire connection
Red LED indication:
Continuous = relay ON
Blinking = relay OFF

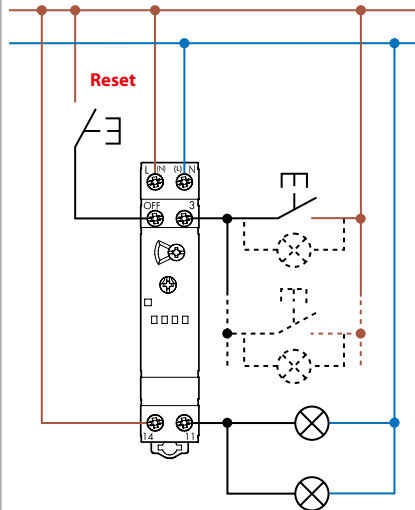

Max 10 (≤ 1 mA)
illuminated push buttons

Type 13.61.0.024

4 wire connection
Red LED indication:
Continuous = relay ON
Blinking = relay OFF

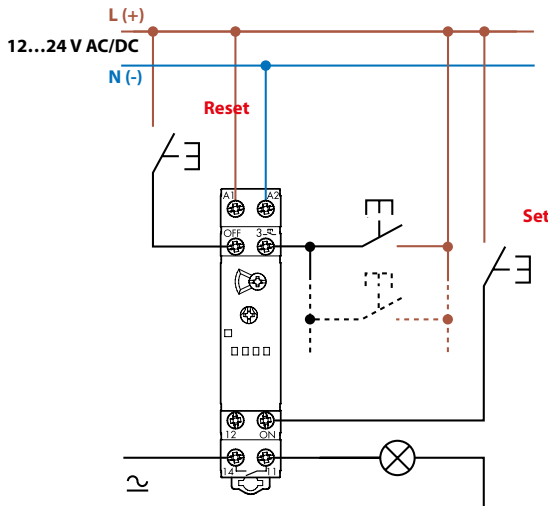

Type 13.61.8.230 - Examples of multiple 4 wire connection with centralized reset pushbutton

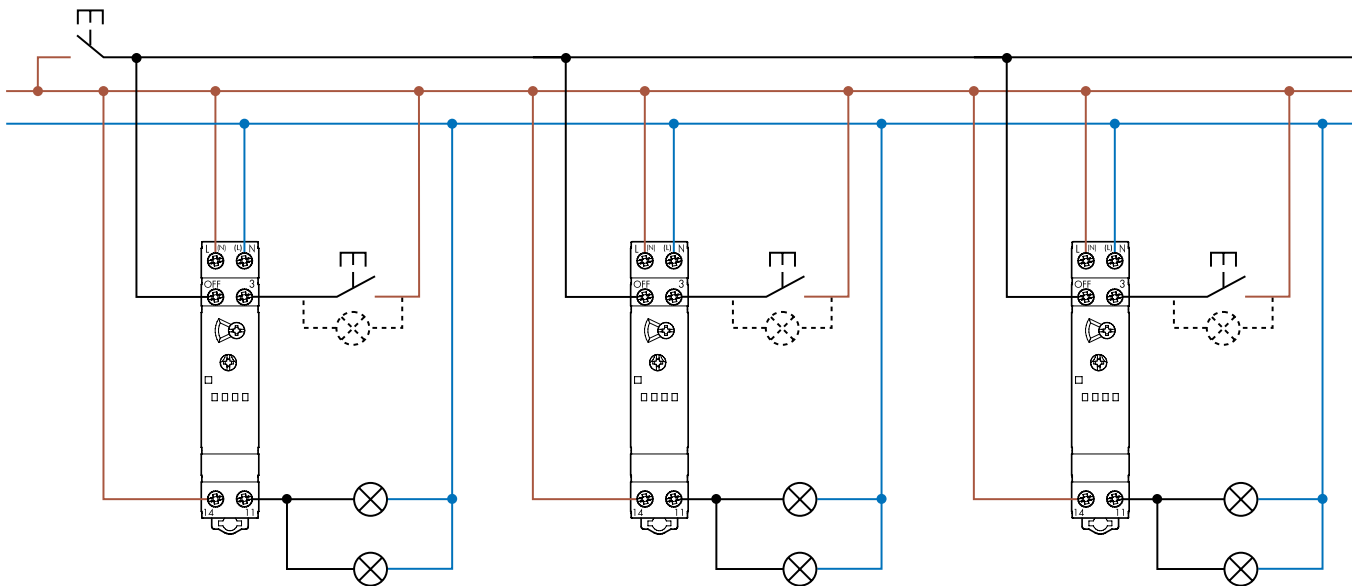

K

Wiring diagrams (13.81 and 13.91)

Type 13.81

3 wire connection
Red LED indication:
Continuous = relay ON
Blinking = relay OFF

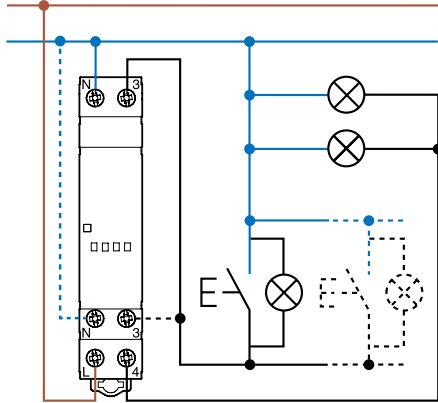

Max 15 (≤ 1 mA)
illuminated push buttons

Type 13.81

4 wire connection
Red LED indication:
Continuous = relay ON
Blinking = relay OFF

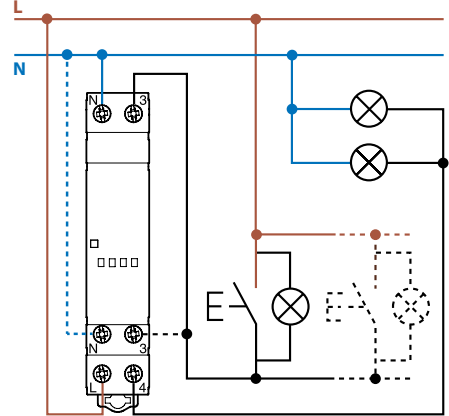

Max 15 (≤ 1 mA)
illuminated push buttons

Type 13.91

3 wire connection

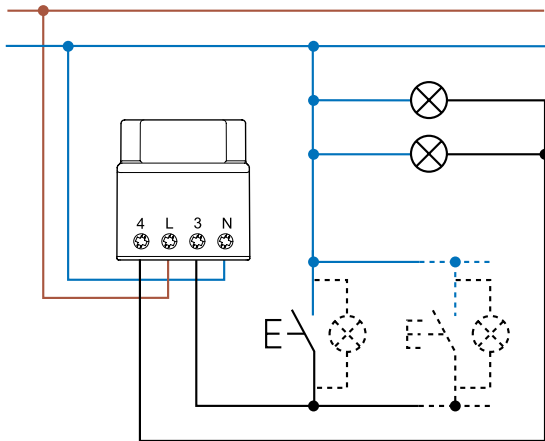

Max 12 (≤ 1 mA)
illuminated push buttons

Type 13.91

4 wire connection

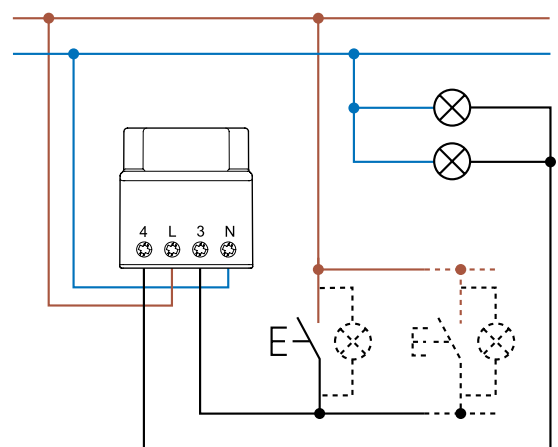

Max 12 (≤ 1 mA)
illuminated push buttons

Outline drawings

13.01
Screw terminal

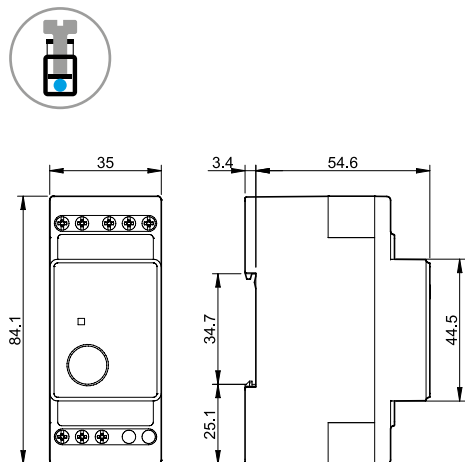

13.11
Screw terminal

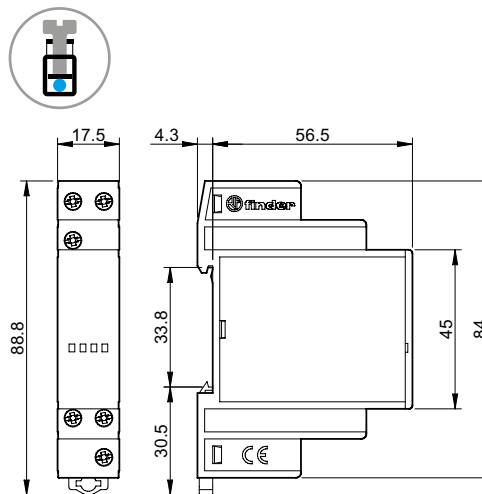

13.12
Screw terminal

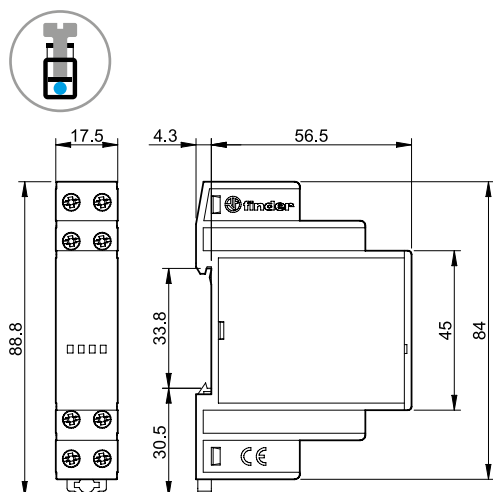

13.31/13.91
Screw terminal

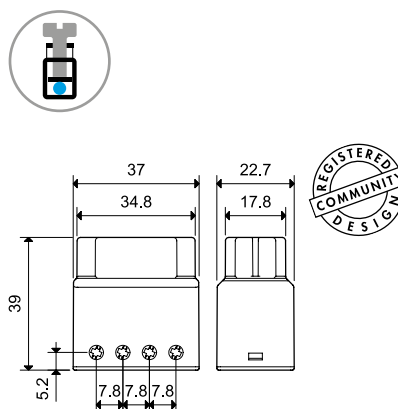

13.61
Screw terminal

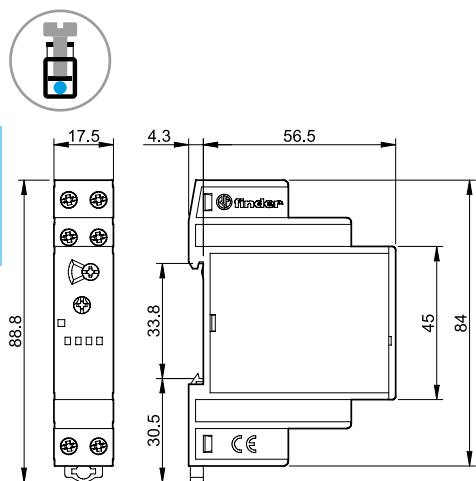

13.81
Screw terminal

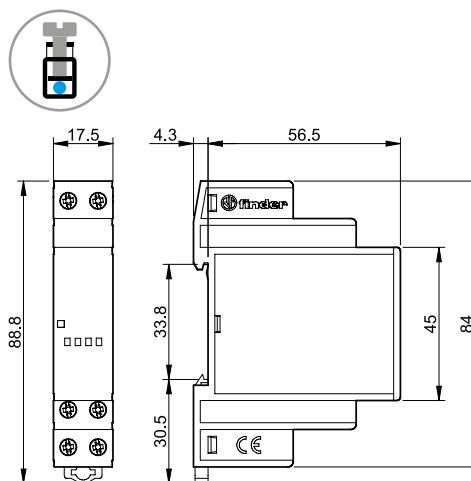

K

Accessories



011.01

Adaptor for panel mounting, for type 13.01, 35 mm wide

011.01



020.01

Adaptor for panel mounting, for type 13.11, 13.12, 13.61 and 13.81, 17.5 mm wide

020.01

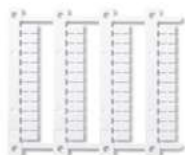

060.48

Sheet of marker tags (CEMBRE Thermal transfer printers) for relays types 13.11, 13.12, 13.61 and 13.81 (48 tags), 6 x 12 mm

060.48

Modular step relays 16 A



Automation for
blinds, grilles
and shutters



Lighting control
in corridors (for
hotels, offices
and hospitals)



Bedroom
light control



Living room
light control



20
SERIES

1 or 2 Pole 16 A Step relays for direct 35 mm rail (EN 60715) mounting

- 17.4 mm wide
- Test button with mechanical indicators
- Choice of 7 switching sequences
- AC coils and DC coils
- Identification label
- Possible to connect illuminated push buttons with the additional part 026.00
- 35 mm rail (EN 60715) mount
- Cadmium free contact material

20.21/22/24/26/27/28/23
Screw terminal



FOR UL RATINGS SEE:
"General technical information" page V

For outline drawing see page 5

Contact specification

Contact configuration	1 NO (SPST-NO)	2 NO (DPST-NO)	1NO+1NC (SPST-NO+SPST-NC)
Rated current/Maximum peak current	A 16/30	16/30	16/30
Rated voltage/ Maximum switching voltage	V AC 250/400	250/400	250/400
Rated load AC1	VA 4000	4000	4000
Rated load AC15 (230 V AC)	VA 750	750	750
Nominal lamp rating:			
230 V incandescent/halogen W	2000	2000	2000
fluorescent tubes with electronic ballast W	1000	1000	1000
fluorescent tubes with electromechanical ballast W	750	750	750
CFL W	400	400	400
230 V LED W	400	400	400
LV halogen or LED with electronic ballast W	400	400	400
LV halogen or LED with electromechanical ballast W	800	800	800
Minimum switching load	mW (V/mA) 1000 (10/10)	1000 (10/10)	1000 (10/10)
Standard contact material	AgSnO ₂	AgSnO ₂	AgSnO ₂

Coil specification

Nominal voltage (U _N)	V AC (50/60 Hz)	8 - 12 - 24 - 48 - 110 - 120 - 230 - 240	
	V DC	12 - 24 - 48 - 110	12 - 24 - 48 - 110
Rated power AC/DC	VA (50 Hz)/W	6.5/5	6.5/5
Operating range	AC	(0.85...1.1)U _N (50 Hz)/(0.9...1.1)U _N (60 Hz)	
	DC	(0.9...1.1)U _N	(0.9...1.1)U _N

Technical data

Mechanical life AC/DC	cycles	300 · 10 ³	300 · 10 ³	300 · 10 ³
Electrical life at rated load in AC1	cycles	100 · 10 ³	100 · 10 ³	100 · 10 ³
Minimum/Maximum impulse duration		0.1 s/1 h (according to EN 60669)	0.1 s/1 h (according to EN 60669)	0.1 s/1 h (according to EN 60669)
Insulation between coil and contacts (1.2/50 μs)	kV	4	4	4
Ambient temperature range	°C	-40...+40	-40...+40	-40...+40
Protection category		IP 20	IP 20	IP 20

Approvals (according to type)



- Single phase switch 1 NO (SPST-NO)
- 35 mm rail (EN 60715) mount

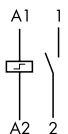

- Double phase switch
- 35 mm rail (EN 60715) mount

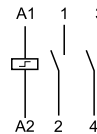

- Double phase switch 1NO+1NC (SPST-NO+SPST-NC)
- 35 mm rail (EN 60715) mount

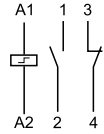

Ordering information

Example: 20 series relay, 35 mm rail (EN 60715) mount, double phase switch, 2 NO 16 A contacts, coil rated at 12 V DC, AgSnO₂ contacts.

2 0 . 2 2 . 9 . 0 1 2 . 4 0 0 0

- Series** —————
- Type** —————
2 = 35 mm rail (EN 60715) mount
- No. of poles** —————
1 = Single phase switch 1 NO (SPST-NO)
2 = Double phase switch 2 NO (DPST-NO)
3 = Double phase switch 1 NC+ 1 NO (SPST-NO+SPST-NC)
4 = 4 sequence double phase switch 2 NO (DPST-NO)
6 = 3 sequence double phase switch 2 NO (DPST-NO)
7 = 3 sequence double phase switch 2 NO (DPST-NO)
8 = 4 sequence double phase switch 2 NO (DPST-NO)
- Contact material**
0 = AgNi
4 = AgSnO₂
- Coil voltage**
See coil specifications
- Coil version**
8 = AC (50/60 Hz)
9 = DC

Technical data

Insulation

Dielectric strength		
between supply and contacts	V AC	3500
between open contacts	V AC	2000
between adjacent contacts	V AC	2000

Other data

Power lost to the environment					
with rated current and coil deenergised	W	1.3 (20.21, 20.23, 20.28)		2.6 (20.22, 20.24, 20.26, 20.27)	
Screw torque	Nm	0.8		0.8	
Max. wire size		Coil terminals		Contact terminals	
		solid cable	stranded cable	solid cable	stranded cable
	mm ²	1 x 4 / 2 x 2.5	1 x 2.5 / 2 x 2.5	1 x 6 / 2 x 4	1 x 4 / 2 x 2.5
	AWG	1 x 12 / 2 x 14	1 x 14 / 2 x 14	1 x 10 / 2 x 12	1 x 12 / 2 x 14

If the coil is operated for a prolonged period of time, adequate ventilation of the relays must be provided - suggested gap of 9 mm between adjacent relays.

Coil specifications

DC version data

Nominal voltage U _N	Coil code	Operating range		Resistance R	Consumption I at U _N
		U _{min}	U _{max}		
V		V	V	Ω	mA
12	9.012	10.8	13.2	27	440
24	9.024	21.6	26.4	105	230
48	9.048	43.2	52.8	440	110
110	9.110	99	121	2330	47

AC version data

Nominal voltage U _N	Coil code	Operating range		Resistance R	Consumption I at U _N (50 Hz)
		U _{min}	U _{max}		
V		V	V	Ω	mA
8	8.008	6.8	8.8	4	800
12	8.012	10.2	13.2	7.5	550
24	8.024	20.4	26.4	27	275
48	8.048	40.8	52.8	106	150
110	8.110	93.5	121	590	64
120	8.120	102	132	680	54
230	8.230	192	253	2500	28
240	8.240	204	264	2700	27.5

Type	Number of steps	Sequence			
		1	2	3	4
20.21	2				
20.22	2				
20.23	2				
20.24	4				
20.26	3				
20.27	3				
20.28	4				

Wiring diagrams

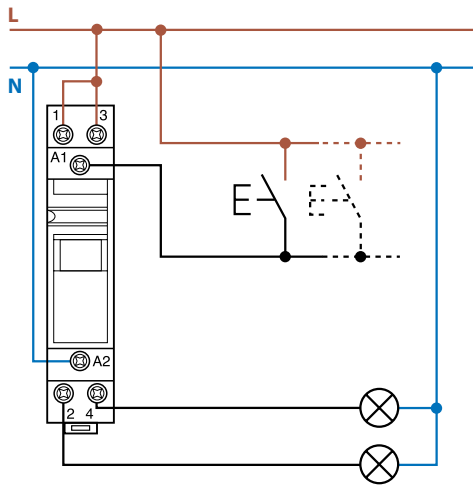

Example: 230 V AC supply voltage.

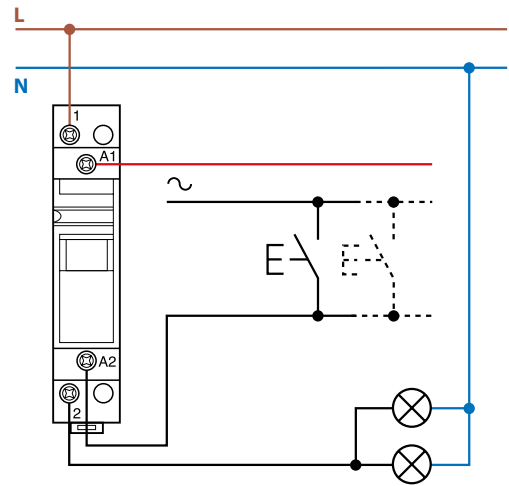

Example: 24 V AC supply voltage.

Outline drawings

20.21

Screw terminal

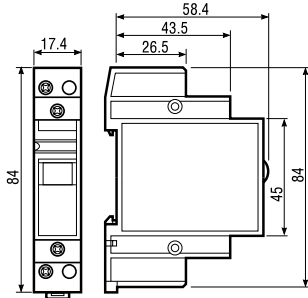

20.22/24/26/27/28

Screw terminal

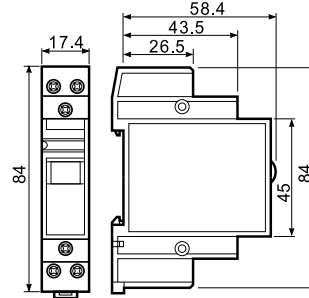

20.23

Screw terminal

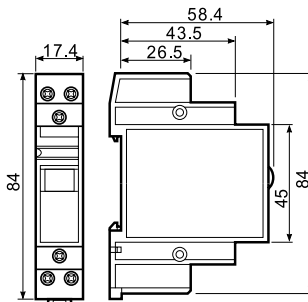

Accessories

Module for use with illuminated push-buttons

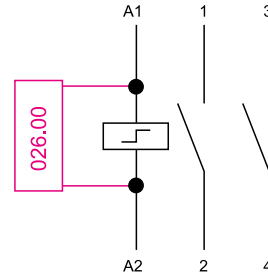
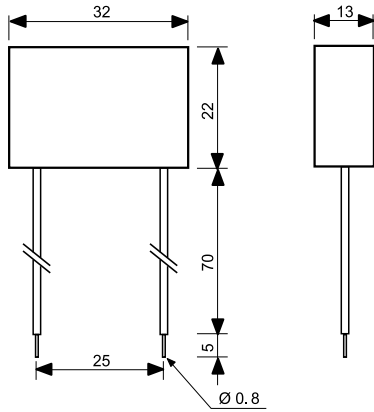

Type 026.00

Sealed construction, 7.5 cm insulated flexible wire termination.

Example of wiring diagram of type 026.00

This module is necessary when using between 1 and a maximum of 15 illuminated push buttons in the coil circuit (Each 1.5 mA max, 230 V AC). It must be connected in parallel to the coil of the relay.



020.01

Adaptor for panel mounting, 17.5 mm wide

020.01



020.24

Sheet of marker tags, plastic, 24 tags, 9 x 17 mm

020.24



022.09

Separator for rail mounting, plastic, 9 mm wide

022.09

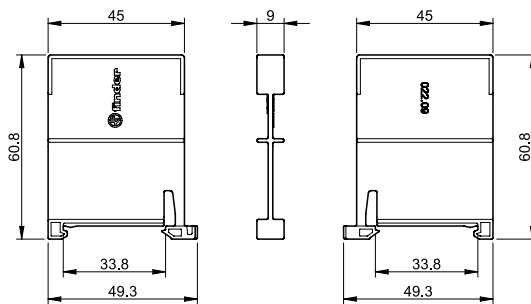

Step relays 10 A



Lighting control
in corridors (for
hotels, offices
and hospitals)



Bedroom
light control



Living room
light control



26
SERIES

1 or 2 Pole electromechanical step relay with electrically separate coil and contact circuits

- Choice of 6 switching sequences
- Screw terminal connections
- AC coil
- Panel mount
- Cadmium free contact material

26.01/02/04/06/08/03

Screw terminal



26.01



- Single phase switch 1 NO (SPST-NO)

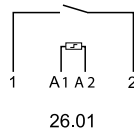

26.02, 04, 06, 08



- Double phase switch 2 NO (DPST-NO)

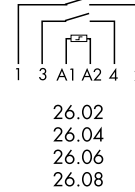

26.03



- 1 NO + 1 NC (SPST-NO + SPST-NC)

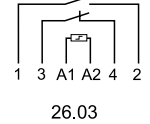

For outline drawing see page 6

Contact specification

Number of contacts		1 NO (SPST-NO)	2 NO (DPST-NO)	1NO+1NC (SPST-NO+SPST-NC)
Rated current/Maximum peak current	A	10/20	10/20	10/20
Rated voltage/ Maximum switching voltage	V AC	250/400	250/400	250/400
Rated load AC1	VA	2500	2500	2500
Rated load AC15 (230 V AC)	VA	500	500	500
Nominal lamp rating:				
230 V incandescent/halogen W		800	800	800
fluorescent tubes with electronic ballast W		400	400	400
fluorescent tubes with electromechanical ballast W		360	360	360
CFL W		200	200	200
230 V LED W		200	200	200
LV halogen or LED with electronic ballast W		200	200	200
LV halogen or LED with electromechanical ballast W		400	400	400
Minimum switching load	mW (V/mA)	1000 (10/10)	1000 (10/10)	1000 (10/10)
Standard contact material		AgNi	AgNi	AgNi

Coil specification

Nominal voltage (UN)	V AC (50 Hz)	12 - 24 - 48 - 110 - 230	12 - 24 - 48 - 110 - 230	12 - 24 - 48 - 110 - 230
	V DC	—	—	—
Rated power AC/DC	VA (50 Hz)/W	4.5/—	4.5/—	4.5/—
Operating range	AC (50 Hz)	(0.8...1.1)U _N	(0.8...1.1)U _N	(0.8...1.1)U _N
	DC	—	—	—

Technical data

Mechanical life AC/DC	cycles	300 · 10 ³	300 · 10 ³	300 · 10 ³
Electrical life at rated load in AC1	cycles	100 · 10 ³	100 · 10 ³	100 · 10 ³
Minimum/Maximum impulse duration		0.1 s/1 h (according to EN 60669)	0.1 s/1 h (according to EN 60669)	0.1 s/1 h (according to EN 60669)
Insulation between coil and contacts (1.2/50 μs)	kV	4	4	4
Ambient temperature range	°C	-40...+40	-40...+40	-40...+40
Protection category		IP 20	IP 20	IP 20

Approvals (according to type)



Ordering information

Example: 26 series screw terminal, panel mount relay, double phase switch 2 NO (DPST-NO) 10 A contacts, coil rated 12 V AC.

2 6 . 0 2 . 8 . 0 1 2 . 0 . 0 . 0 . 0

- Series** —————
- Type** —————
0 = Screw terminal
- No. of poles** —————
1 = Single phase switch 1 NO (SPST-NO)
2 = Double phase switch 2 NO (DPST-NO)
3 = Double phase switch 1 NO + 1 NC (SPST-NO + SPST-NC)
4 = 4 sequences double phase switch 2 NO (DPST-NO)
6 = 3 sequences double phase switch 2 NO (DPST-NO)
8 = 4 sequences double phase switch 2 NO (DPST-NO)
- Coil voltage** —————
See coil specifications
- Coil version** —————
8 = AC (50 Hz)

Technical data

Insulation				
Dielectric strength				
between supply and contacts	V AC	3500		
between open contacts	V AC	2000		
between adjacent contacts	V AC	2000		
Other data		26.01, 26.03, 26.08	26.02, 26.04, 26.06	
Power lost to the environment				
with rated current and coil de-energised W		0.9		1.8
Screw torque	Nm	0.8		0.8
Max. wire size		solid cable	stranded cable	solid cable
	mm ²	1 x 4 / 2 x 2.5	1 x 2.5 / 2 x 2.5	1 x 4 / 2 x 2.5
	AWG	1 x 12 / 2 x 14	1 x 14 / 2 x 14	1 x 12 / 2 x 14
			stranded cable	
				1 x 2.5 / 2 x 2.5
				1 x 14 / 2 x 14

Coil specifications

AC version data

Nominal voltage U_N	Coil code	Operating range		Resistance	Consumption
		U_{min}	U_{max}	R	I at U_N (50 Hz)
V		V	V	Ω	mA
12	8.012	9.6	13.2	17	370
24	8.024	19.2	26.4	70	180
48	8.048	38.4	52.8	290	90
110	8.110	88	121	1500	40
230	8.230	184	253	6250	20

Type	Number of steps	Sequence			
		1	2	3	4
26.01	2				
26.02	2				
26.03	2				
26.04	4				
26.06	3				
26.08	4				

Wiring diagrams

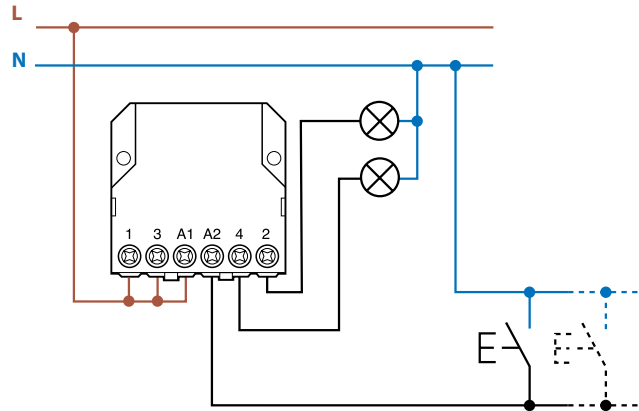

Accessories

for 12 and 24 V DC control applications

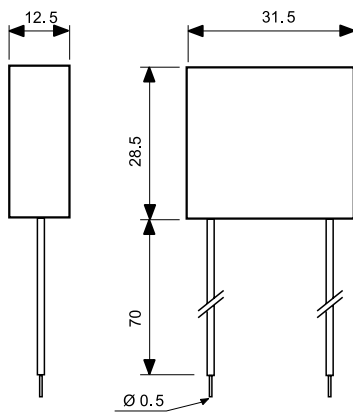

Type: 026.9.012

Nominal voltage: 12 V DC
Max temperature: +40 °C
Operating range: (0.9...1.1)U_N

Type: 026.9.024

Nominal voltage: 24 V DC
Max temperature: +40 °C
Operating range: (0.9...1.1)U_N

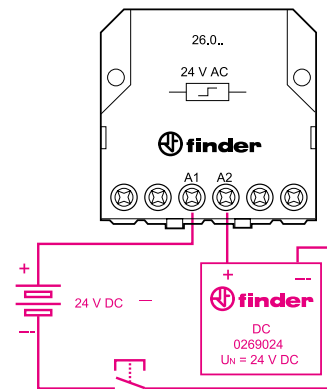

Example of wiring for 24 V DC control application.

Module for use with illuminated push buttons (230 V AC applications)

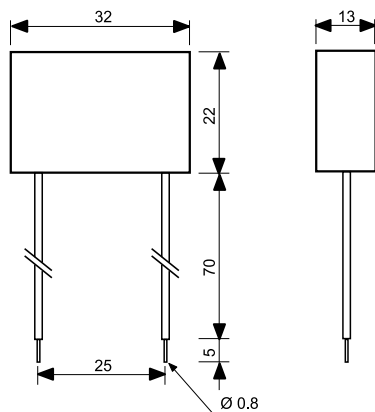

Type 026.00

Sealed construction, 7.5 cm insulated flexible wire termination.

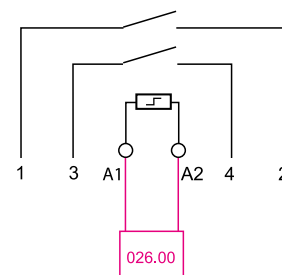

Example of wiring diagram of type 026.00

This module is necessary when using between 1 and a maximum of 15 illuminated push buttons in the coil circuit (Each 1 mA max, 230 V AC). It must be connected in parallel to the coil of the relay (see diagram).

Outline drawings

26.01
Screw terminal

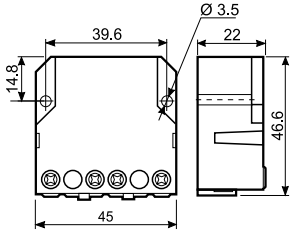

26.02 / 04 / 06 / 08
Screw terminal

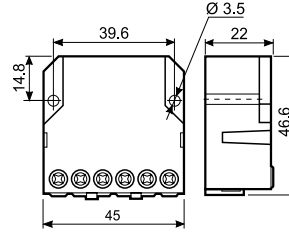

26.03
Screw terminal

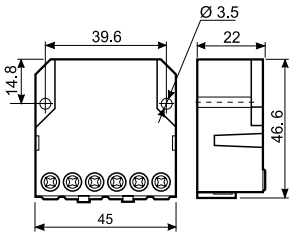

Step relays 10 A



Lighting control
in corridors (for
hotels, offices
and hospitals)



Bedroom
light control



Living room
light control



27
SERIES

1 or 2 Pole electromechanical step relay, for electrically common coil and contact circuits

27.0x - Connect up to 24 illuminated push buttons with the addition of module 027.00

27.2x - Connect up to 15 illuminated push buttons (without additional module) - incorporates coil power limiter to permit continuous coil energisation

- Choice of 3 switching sequences
- Screw terminal connections
- AC coil
- Panel mount
- Cadmium free contact material
- Italian Patent

27.0x / 2x
Screw terminal



For outline drawing see page 5

Contact specification

Number of contacts	1 or 2		1 or 2
Rated current/Maximum peak current	A		10/20
Rated voltage/ Maximum switching voltage	V AC	110/—	230/—
Rated load AC1	VA	1100	2300
Rated load AC15	VA	250	500
Nominal lamp rating:			
230 V incandescent/halogen W	—	1000	1000
fluorescent tubes with electronic ballast W	200	400	400
fluorescent tubes with electromechanical ballast W	180	360	360
CFL W	100	200	200
230 V LED W	—	200	200
LV halogen or LED with electronic ballast W	100	200	200
LV halogen or LED with electromechanical ballast W	200	400	400
Minimum switching current	mW (V/mA)	10	
Standard contact material		AgNi	

Coil specification

Nominal voltage (U _N)	V AC (50/60 Hz)	110	230	230
	V DC	—		
Pickup/continuous power	VA (50 Hz)	4/4		25/1
Operating range	AC 50 Hz/AC 60 Hz	(0.8...1.1)U _N / (0.85...1.1)U _N		
	DC	—		

Technical data

Mechanical life AC/DC	cycles	300 · 10 ³		300 · 10 ³
Electrical life at rated load in AC1	cycles	100 · 10 ³		100 · 10 ³
Max no. of illuminated push-button	(≤ 1 mA)	4 (24 with module 027.00)		15
Minimum/Maximum impulse duration		0.1 s/1 h (according to EN 60669)		0.1 s/continuous
Ambient temperature range	°C	-40...+40		-40...+40
Protection category		IP 20		IP 20

Approvals (according to type)



27.0x



- Single or 2 double phase switch 1 NO (SPST-NO) or 2 NO (DPST-NO)

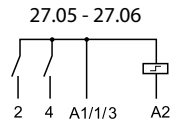
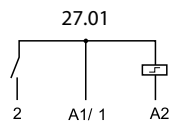

27.2x EVO



- Single or 2 double phase switch 1 NO (SPST-NO) or 2 NO (DPST-NO) with coil power limiter

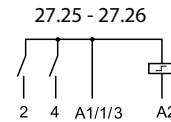
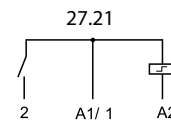

Ordering information

Example: 27 series screw terminal, panel mount step relay, single phase switch 1 NO (SPST-NO) 10 A contact, coil rated 230 V AC.

2 7 . 0 . 1 . 8 . 2 3 0 . 0 . 0 . 0 . 0

- Series** ————
- Type** ————
- 0 = Clamp terminal
2 = Clamp terminal, with coil power limiter
- No. of poles** ————
- 1 = Single phase switch 1 NO (SPST-NO)
5 = 4 sequences double phase switch 2 NO (DPST-NO)
6 = 3 sequences double phase switch 2 NO (DPST-NO)
- Coil voltage** ————
See coil specifications
- Coil version** ————
8 = AC (50/60 Hz)

Technical data

Other data		27.01, 27.21		27.05, 27.06, 27.25, 27.26	
Power lost to the environment with rated current and coil de-energised	W	0.9		1.8	
Screw torque	Nm	0.8		0.8	
Max. wire size		solid cable	stranded cable	solid cable	stranded cable
	mm ²	2 x 2.5	1 x 4 / 2 x 2.5	2 x 2.5	1 x 4 / 2 x 2.5
	AWG	2 x 14	1 x 12 / 2 x 14	2 x 14	1 x 12 / 2 x 14

Coil specifications

Types 27.01, 27.05, 27.06

Nominal voltage U_N V	Coil code	Operating range (50 Hz)		Resistance R Ω	Consumption I at U_N (50 Hz) mA
		U_{min} V	U_{max} V		
110	8.110	88	121	1400	42.0
230	8.230	184	253	6500	17.5

Type	Number of steps	Sequence			
		1	2	3	4
27.01/21	2				
27.05/25	4				
27.06/26	3				

Types 27.21, 27.25, 27.26

Nominal voltage U_N V	Coil code	Operating range (50 Hz)		Resistance R Ω	Consumption	
		U_{min} V	U_{max} V		pick up I at U_N (50 Hz) mA	continuous I at U_N (50 Hz) mA
230	8.230	184	253	1250	100	4

Wiring diagram

Type 27.01/05/06

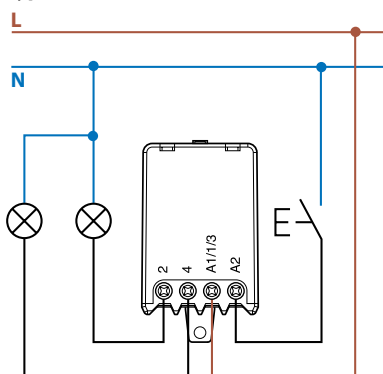

Type 27.21/25/26

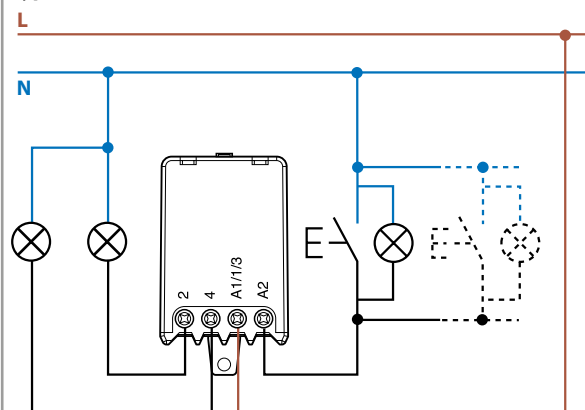

Accessories for types 27.01, 27.05, 27.06

Module for illuminated push-button (230 V AC applications)

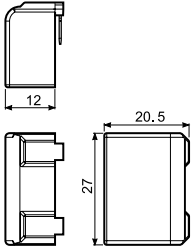

Type 027.00

This module is necessary if using up to a maximum of 24 illuminated push-buttons (1 mA max, 230 V AC) in the switching input circuit. It must be plugged directly into the relay.

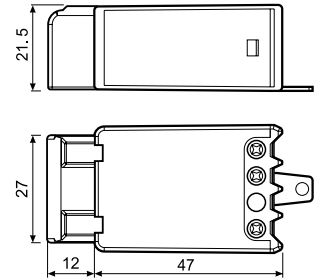

Type 27.0x + 027.00

Outline drawings

27.0x / 2x
Screw terminal

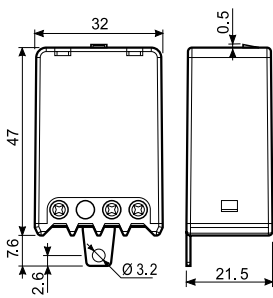



finder[®]
SWITCH TO THE FUTURE

Modular contactors 25 - 40 - 63 A



Hotel room
energy-enabling
units



Garden and
night lighting



Streetlights and
car park lighting



Bathrooms
lighting
control



Office lighting
control



Pump control

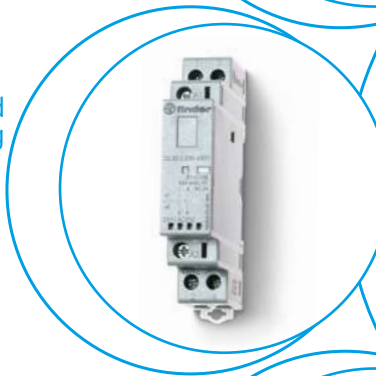

22
SERIES

22.32.A modular contactor - 2 pole

- 17.5 mm wide
- NO contact gap ≥ 3 mm, double break
- Continuous duty for the coil and contacts
- AC/DC silent coil (with varistor protection)
- Protective separation (reinforced insulation) between coil and contacts
- Mechanical and LED indicators as standard
- Auto-On-Off selector version available
- AgNi and AgSnO₂ contact versions available
- Compliant with EN 61095: 2009
- Auxiliary contact module available, quick-assembly with the main contactor (1 NO + 1 NC and 2 NO versions)
- For railway applications; materials compliant with fire and smoke characteristics (EN 45545-2:2013)
- 35 mm rail (EN 60715) mount

22.32...1xx0/22.32...4xx0

Screw terminal



For outline drawings see page 10

Contact specification

Contact configuration	2 NO, 3 mm* (or 1 NO + 1 NC or 2 NC)	
Rated current/Maximum peak current	A	25/80
Rated voltage	V AC	250/440
Rated load AC1 / AC-7a (per pole @ 250 V)	VA	6250
Rated current AC3 / AC-7b	A	10
Rated load AC15 (per pole @ 230 V)	VA	1800
Single-phase motor rating (230 V AC)	kW	1
Rated load AC5a (per pole @ 250 V)	A	15
Rated current AC-7c	A	—
Nominal lamp rating:		
230 V incandescent/halogen W		800
fluorescent tubes with electronic ballast W		300
fluorescent tubes with electromechanical ballast W		200
CFL W		100
230 V LED W		100
LV halogen or LED with electronic ballast W		100
LV halogen or LED with electromechanical ballast W		300
Breaking capacity DC1: 30/110/220 V	A	25/5/1
Minimum switching load	mW (V/mA)	1000 (10/10)
Contact material		AgNi

Coil specification

Nominal voltage (U _N)	V DC/AC (50/60 Hz)	12 - 24 - 48 - 60 - 120 - 230	12 - 24 - 48 - 60 - 120 - 230
Rated power AC/DC	VA (50 Hz)/W	2/2.2	2/2.2
Operating range	DC/AC (50/60 Hz)	(0.8...1.1)U _N	(0.8...1.1)U _N
Holding voltage	DC/AC (50/60 Hz)	0.4 U _N	0.4 U _N
Must drop-out voltage	DC/AC (50/60 Hz)	0.1 U _N	0.1 U _N

Technical data

Mechanical life AC/DC	cycles	2 · 10 ⁶	2 · 10 ⁶
Electrical life at rated load AC-7a	cycles	70 · 10 ³	30 · 10 ³
Operate/release time	ms	30/20	30/20
Insulation between coil and contacts (1.2/50 μs)	kV	6	6
Ambient temperature range	°C	-20...+50	-20...+50
Protection category		IP 20	IP 20

Approvals (according to type)

22.32.0.xxx.1xx0



- AgNi contacts, specifically intended for resistive and slightly inductive loads as well as for motor loads

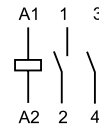

2 NO
(x3x0)

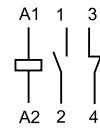

1 NO + 1 NC
(x5x0)

22.32.0.xxx.4xx0



- AgSnO₂ contacts, specifically intended for lamp loads and for high inrush current loads

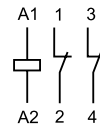

2 NC
(x4x0)

- Contact gap ≥ 3 mm for NO contacts only;
NC contacts ≥ 1.5 mm



25 A modular contactor - 4 pole

- 35 mm wide
- NO contact gap ≥ 3 mm, double break
- Continuous duty for the coil and contacts
- AC/DC silent coil (with varistor protection)
- Protective separation (reinforced insulation) between coil and contacts
- Mechanical and LED indicators as standard
- Auto-On-Off selector version available
- AgNi and AgSnO₂ contact versions available
- Compliant with EN 61095: 2009
- Auxiliary contact module available, quick-assembly with the main contactor (1 NO + 1 NC and 2 NO versions)
- For railway applications; materials compliant with fire and smoke characteristics (EN 45545-2:2013)
- 35 mm rail (EN 60715) mount

22.34...1xx0/22.34...4xx0

Screw terminal



For outline drawings see page 10

Contact specification

Contact configuration	4 NO, 3 mm* (or 3NO + 1NC or 2NO + 2NC)		
Rated current/Maximum peak current	A	25/80	25/120
Rated voltage	V AC	250/440	250/440
Rated load AC1/AC-7a (per pole @ 250 V)	VA	6250	6250
Rated current AC3/AC-7b	A	10	10
Rated load AC15 (per pole @ 230 V)	VA	1800	1800
Three-phase motor rating (400 - 440 V AC)	kW	4	4
Rated load AC5a (per pole @ 250 V)	A	15	15
Rated current AC-7c	A	—	10
Nominal lamp rating:			
230 V incandescent/halogen W		800	2000
fluorescent tubes with electronic ballast W		300	800
fluorescent tubes with electromechanical ballast W		200	500
CFL W		100	200
230 V LED W		100	200
LV halogen or LED with electronic ballast W		100	200
LV halogen or LED with electromechanical ballast W		300	800
Breaking capacity DC1: 30/110/220 V	A	25/5/1	25/5/1
Minimum switching load	mW (V/mA)	1000 (10/10)	1000 (10/10)
Contact material		AgNi	AgSnO ₂

Coil specification

Nominal voltage (U _N)	V DC/AC (50/60 Hz)	12 - 24 - 48 - 60 - 120 - 230	12 - 24 - 48 - 60 - 120 - 230
Rated power AC/DC	VA (50 Hz)/W	2/2.2	2/2.2
Operating range	DC/AC (50/60 Hz)	(0.8...1.1)U _N	(0.8...1.1)U _N
Holding voltage	DC/AC (50/60 Hz)	0.4 U _N	0.4 U _N
Must drop-out voltage	DC/AC (50/60 Hz)	0.1 U _N	0.1 U _N

Technical data

Mechanical life AC/DC	cycles	2 · 10 ⁶	2 · 10 ⁶
Electrical life at rated load AC-7a	cycles	150 · 10 ³	30 · 10 ³
Operate/release time	ms	18/40	18/40
Insulation between coil and contacts (1.2/50 μs)	kV	6	6
Ambient temperature range	°C	-20...+50	-20...+50
Protection category		IP 20	IP 20

Approvals (according to type)



22.34.0.xxx.1xx0



- AgNi contacts, specifically intended for resistive and slightly inductive loads as well as for motor loads

22.34.0.xxx.4xx0



- AgSnO₂ contacts, specifically intended for lamp loads and for high inrush current loads

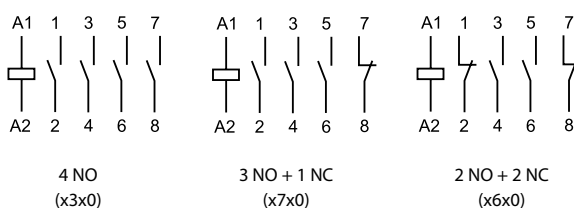

- Contact gap ≥ 3 mm for NO contacts only;
NC contacts ≥ 1.5 mm

40 - 63 A modular contactor - 4 pole

- NO and NC contact gap ≥ 3 mm, double break
- Continuous duty for the coil and contacts
- AC/DC silent coil (with varistor protection)
- Protective separation (reinforced insulation) between coil and contacts
- Mechanical indicator as standard
- AgSnO₂ contacts
- Compliant with EN 61095: 2009 and with EN 60947-4-1: 2009
- 35 mm rail (EN 60715) mount

22.44.../22.64...

Screw terminal



For outline drawings see page 10

Contact specification

Contact configuration	4 NO, (or 3NO + 1NC or 2NO + 2NC) ≥ 3 mm		
Rated current/Maximum peak current	A	40/176	63/240
Rated voltage	V AC	400/440	400/440
Rated load AC1 / AC-7a (per pole @ 400 V)	VA	16000	24000
Rated current AC3 / AC-7b (400 V)	A	22	30
Rated load AC15 (per pole @ 230 V)	VA	—	—
Three-phase motor rating (400 - 440 V AC)	kW	11	15
Rated load AC5a (per pole @ 250 V)	A	20	32
Rated current AC-7c	A	—	—
Nominal lamp rating:			
230 V incandescent/halogen W		4000	5000
fluorescent tubes with electronic ballast W		1500	2000
fluorescent tubes with electromechanical ballast W		1500	2000
CFL W		1000	1500
230 V LED W		1000	1500
LV halogen or LED with electronic ballast W		1000	1500
LV halogen or LED with electromechanical ballast W		1500	2000
Breaking capacity DC1: 30/110/220 V	A	40/4/1.2	63/4/1.2
Minimum switching load	mW (V/mA)	1000 (17/50)	1000 (17/50)
Contact material		AgSnO ₂	AgSnO ₂

Coil specification

Nominal voltage (U _N)	V DC/AC (50/60 Hz)	12 - 24 - 110...120 (110 V DC) - 230...240 (220 V DC)	
Rated power AC/DC	VA (50 Hz)/W	5	5
Operating range	DC/AC (50/60 Hz)	(0.85...1.1)U _N	(0.85...1.1)U _N
Holding voltage	DC/AC (50/60 Hz)	0.85 U _N	0.85 U _N
Must drop-out voltage	DC/AC (50/60 Hz)	0.2 U _N	0.2 U _N

Technical data

Mechanical life AC/DC	cycles	3 · 10 ⁶	3 · 10 ⁶
Electrical life at rated load AC-7a	cycles	100 · 10 ³	100 · 10 ³
Operate/release time	ms	20/45	20/45
Insulation between coil and contacts (1.2/50 μ s)	kV	6	6
Ambient temperature range	°C	-5...+55	-5...+55
Protection category		IP 20	IP 20

Approvals (according to type)



NEW 22.44.0.xxx.4xx0



- For high inrush current loads 176 A
- Contact material AgSnO₂

NEW 22.64.0.xxx.4xx0



- Specifically intended: for high inrush current loads 240 A
- Contact material AgSnO₂

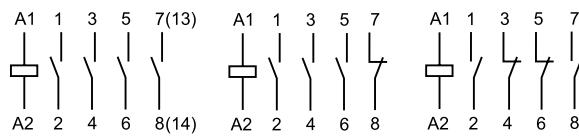

4 NO
(4310)

3 NO + 1 NC
(4710)

2 NO + 2 NC
(4610)

Ordering information

Example: 22 series, modular contactor 25 A, 4 NO contacts, coil 230 V AC/DC, AgSnO₂ contacts, Auto-On-Off selector + mechanical indicator + LED.

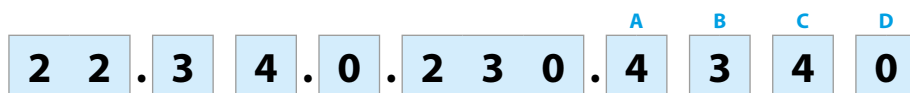

Series
Type
 3 = 25 A modular contactor range
 4 = 40 A modular contactor range
 6 = 63 A modular contactor range
Number of contacts
 2 = 2 pole
 4 = 4 pole
Coil version
 0 = AC (50/60 Hz)/DC
Coil rated voltage
 See coil specifications

D: Special versions
 0 = Standard
C: Options
 1 = Mechanical indicator
 2 = Mechanical indicator + LED
 4 = Auto-On-Off selector + mechanical indicator + LED
B: Contact circuit
 3 = All NO contacts
 4 = All NC contacts (22.32 only)
 5 = 1 NO + 1 NC
 6 = 2 NO + 2 NC
 7 = 3 NO + 1 NC
A: Contact material
 1 = AgNi
 4 = AgSnO₂

Selecting features and options: only combinations in the same row are possible.
 Preferred selections for best availability are shown in **bold**.

Type	Coil version	A	B	C	D
22.32	AC/DC	1 - 4	3 - 4 - 5	2 - 4	0
22.34	AC/DC	1 - 4	3 - 6 - 7	2 - 4	0
22.44	AC/DC	4	3 - 6 - 7	1	0
22.64	AC/DC	4	3 - 6 - 7	1	0

Options

Auto-On-Off selector + mechanical indicator + LED (xx40 option)

Type 22.32 / 22.34

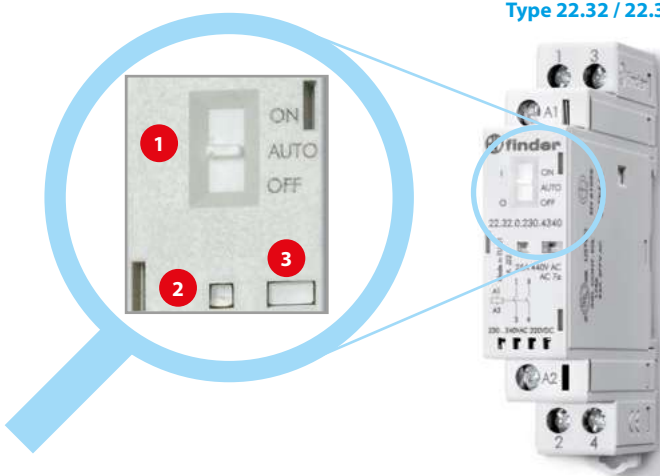

Options

- 1 Selector**
 The three-position manual selector has the following functions:
 - **ON position** - the contacts are latched in the operated state (NO contacts - closed and NC contacts - open), the mechanical indicator is visible in its window, the LED is not illuminated.
 - **AUTO position** - the state of contacts, mechanical indicator and LED follow the coil supply voltage.
 - **OFF position** - even if terminals A1 - A2 are supplied with rated voltage, the coil is not energized, and so the contacts remain in the non-operated state, the mechanical indicator is not visible and the LED is not illuminated.

- 2 LED**
- 3 Mechanical indicator**

Type 22.44 / 22.64

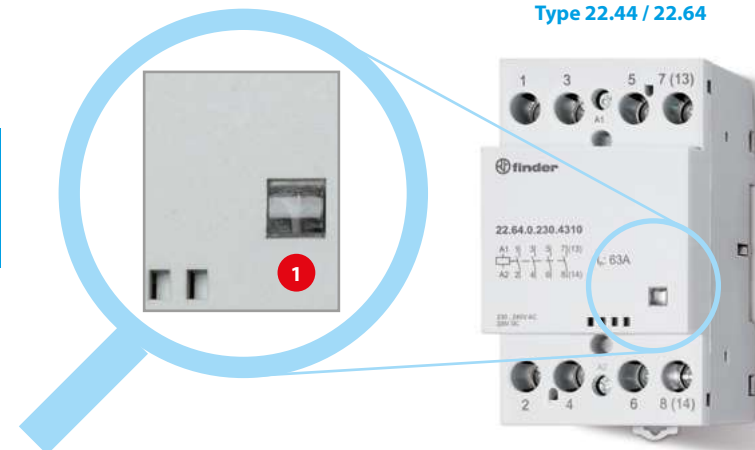

Options

Mechanical indicator

Technical data

Insulation		22.32/22.34		22.44/22.64		
Rated insulation voltage	V AC	250	440	440		
Pollution degree		3*	2	3		
Insulation between coil and contact set						
Type of insulation		Reinforced		Reinforced		
Overvoltage category		III		III		
Rated impulse voltage	kV (1.2/50 μs)	6		4		
Dielectric strength	V AC	4000		2000		
Insulation between adjacent contacts						
Type of insulation		Basic		Basic		
Overvoltage category		III		III		
Rated impulse voltage	kV (1.2/50 μs)	4		4		
Dielectric strength	V AC	2500		2000		
Insulation between open contacts		NO contact	NC contact	NO/NC contacts		
Contact gap	mm	3	1.5	3		
Overvoltage category		III	II	III		
Rated impulse voltage	kV (1.2/50 μs)	4	2.5	4		
Dielectric strength	V AC/kV (1.2/50 μs)	2500/4	2000/3	2000/3		
* Only for versions without Auto-On-Off selector. For versions with Auto-On-Off selector pollution degree 2 applies.						
Conducted disturbance immunity		Reference standard				
Fast transients (burst 5/50 ns, 5 kHz) at coil terminals according to EN 61000-4-4		Level 4 (4 kV)		Level 2 (2 kV)		
Voltage pulses (surge 1.2/50 μs) at supply terminals (differential mode) according to EN 61000-4-5		Level 4 (4 kV)		Level 2 (2 kV)		
Short circuit protection		22.32 / 22.34	22.44	22.64		
Rated conditional short circuit current	kA	3	3	3		
Back-up fuse	A	32 (gL/gG type)	63	80		
Terminals		Solid and stranded cable				
		22.32 / 22.34	22.44 / 22.64			
Max. wire size – contact terminals	mm ²	1 x 6 / 2 x 4		1 x 25 (solid) - 1 x 16 (stranded)		
	AWG	1 x 10 / 2 x 12		1 x 4 (solid) - 1 x 6 (stranded)		
Max. wire size – coil terminals	mm ²	1 x 4 / 2 x 2.5		1 x 2.5		
	AWG	1 x 12 / 2 x 14		1 x 14		
Min. wire size – contact and coil terminals	mm ²	1 x 0.2		1 x 1 (coil) - 1 x 1.5 (contacts)		
	AWG	1 x 24		1 x 18 (coil) - 1 x 16 (contacts)		
Screw torque	Nm	0.8		1.2 (coil terminals) - 3.5 (contact terminals)		
Wire strip length	mm	9		10		
Other data		22.32	22.34	22.44	22.64	
Vibration resistance (10...150)Hz	g	4	4	3	3	
Shock resistance	g	10	10	15	15	
Power lost to the environment	without contact current	W	2	2	5	5
	with rated current	W	4.8	6.3	17	37

NOTE

22.32/22.34: It is suggested an air gap of 9 mm between adjacent relays for installations and working conditions close to the limit (that is, ambient temperature > 40 °C, coil operated for a prolonged period of time, all contacts loaded with current > 20 A).

22.44/22.64: The maximum ambient temperature with 3 adjacent contactors is + 40 °C; when more than 3 contactors are installed, it is necessary an air gap of 9 mm.

With 2 adjacent contactors the maximum ambient temperature is + 55 °C; when more than 2 contactors are installed, it is necessary an air gap of 9 mm.

Contact specification

Ratings and utilization categories according to EN 61095: 2009

Type	Utilization category					
	AC-7a		AC-7b		AC-7c	
	Rated current (A)	Rated electrical life (Cycles)	Rated current (A)	Rated electrical life (Cycles)	Rated current (A)	Rated electrical life (Cycles)
22.32....1xx0 (AgNi contacts)	25	70 · 10 ³ (NO)	10	30 · 10 ³	—	—
		30 · 10 ³ (NC)				
22.32....4xx0 (AgSnO ₂ contacts)	25	30 · 10 ³	10	30 · 10 ³	10	30 · 10 ³
22.34....1xx0 (AgNi contacts)	25	150 · 10 ³ (NO)	10	30 · 10 ³	—	—
		100 · 10 ³ (NC)				
22.34....4xx0 (AgSnO ₂ contacts)	25	30 · 10 ³	10	30 · 10 ³	10	30 · 10 ³
22.44....4xx0	40	100 · 10 ³	22	150 · 10 ³	—	—
22.64....4xx0	63	100 · 10 ³	30	150 · 10 ³	—	—

Utilization category: **AC-7a** = Slightly inductive loads ($\cos \varphi = 0.8$)

AC-7b = Motor loads; ($\cos \varphi = 0.45$, $I_{making} = 6x I_{breaking}$)

AC-7c = Compensated electric discharge lamps ($\cos \varphi = 0.9$, $C = 10 \text{ mF/A}$)

H 22 - Maximum DC1 breaking capacity - Type 22.32/22.34

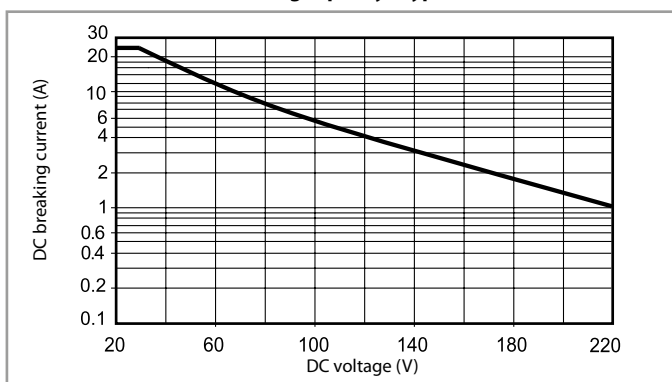

H 22 - Maximum DC1 breaking capacity - Type 22.44/22.64

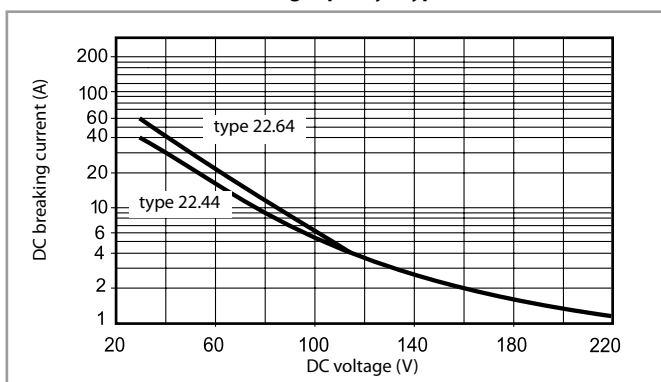

• When switching a resistive load (DC1) having voltage and current values under the curve, an electrical life of $\geq 100 \cdot 10^3$ can be expected.

• In the case of DC13 loads, the connection of a diode in parallel with the load will permit a similar electrical life as for a DC1 load.

Note: the release time for the load will be increased.

Coil specifications

AC/DC version data (type 22.32)

Nominal voltage U_N V	Coil code	Operating range		Rated coil consumption I_N at U_N (AC) mA
		U_{min} V	U_{max} V	
12	0.012	9.6	13.2	165
24	0.024	19.2	26.4	83
48	0.048	38.4	52.8	42
60	0.060	48	66	33
120 (110...125)	0.120	88	138	16.5
230 (230...240 AC) (220 DC)	0.230	184 (AC) 176 (DC)	264 (AC) 242 (DC)	8.7

AC/DC version data (type 22.34)

Nominal voltage U_N V	Coil code	Operating range		Rated coil consumption I_N at U_N (AC) mA
		U_{min} V	U_{max} V	
12	0.012	9.6	13.2	165
24	0.024	19.2	26.4	83
48	0.048	38.4	52.8	42
60	0.060	48	66	33
120 (110...125)	0.120	88	138	16.5
230 (230...240 AC) (220 DC)	0.230	184 (AC) 176 (DC)	264 (AC) 242 (DC)	8.7

AC/DC version data (type 22.44 / 22.64)

Nominal voltage U_N V	Coil code	Operating range		Rated coil consumption I_N at U_N (AC) mA
		U_{min} V	U_{max} V	
12	0.012	10.2	13.2	417
24	0.024	20.4	26.4	208
120 (110...125)	0.120	102	138	41
230 (230...240 AC) (220 DC)	0.230	196	264 (AC) 242 (DC)	21

R 22 - Coil operating range v ambient temperature

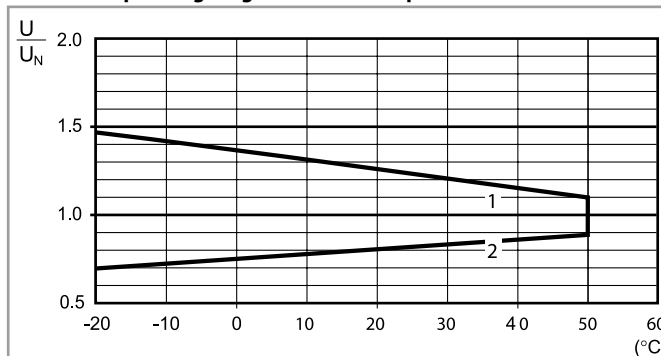

1 - Max. permitted coil voltage.

2 - Min. pick-up voltage with coil at ambient temperature.

Wiring diagrams

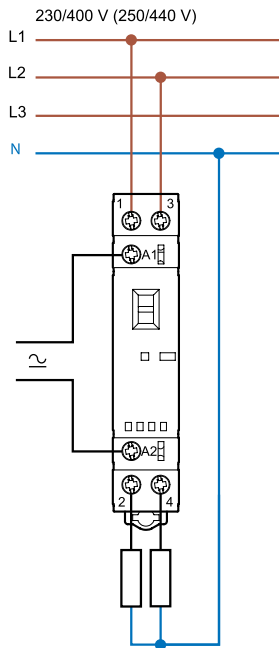

Type 22.32

Line and neutral switched

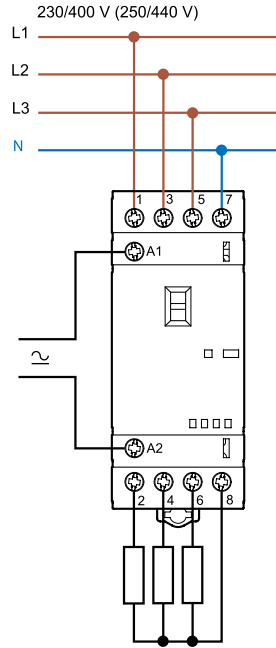

Type 22.34

Line only switched

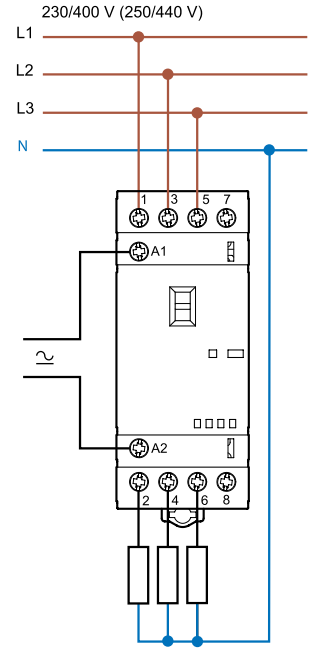

Type 22.34

Line and neutral switched

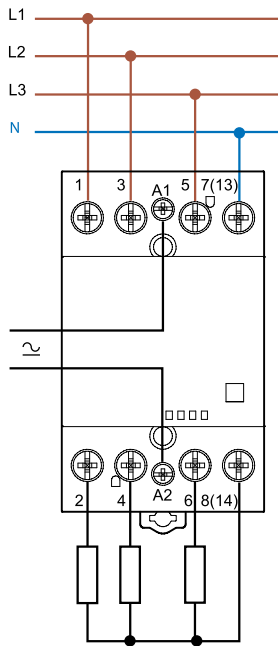

Type 22.44/22.64

Line only switched

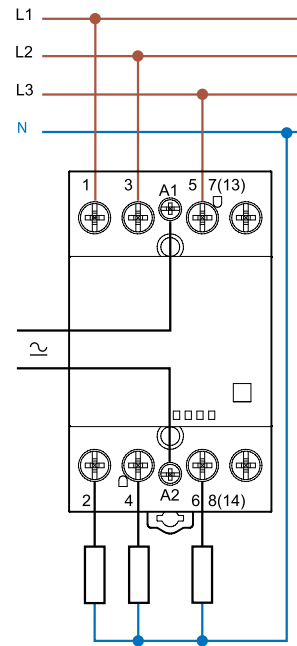

Type 22.44/22.64

Outline drawings

Type 22.32
Screw terminal

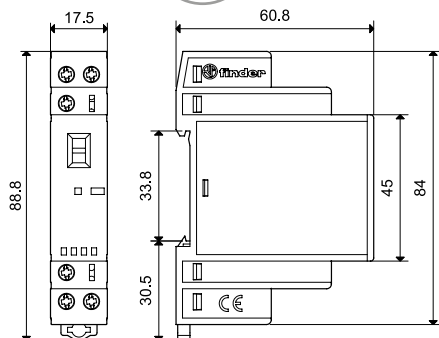

Type 22.32 + 022.33/022.35
Screw terminal

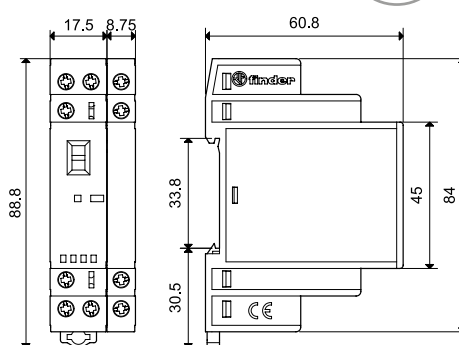

Type 22.34
Screw terminal

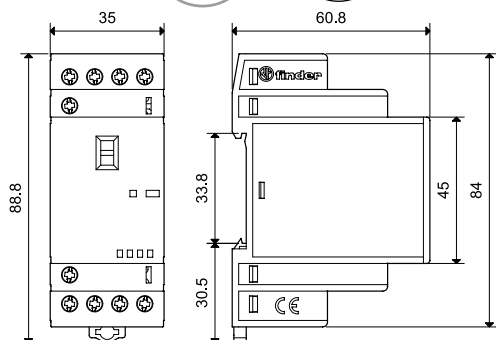

Type 22.34 + 022.33/022.35
Screw terminal

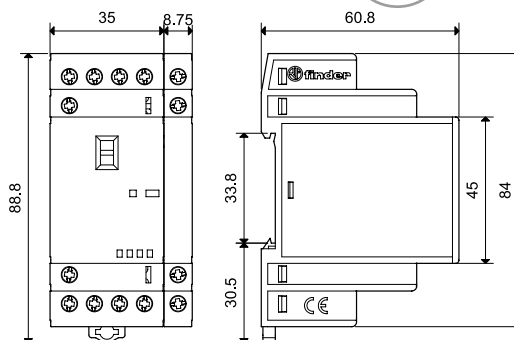

Type 22.44/22.64
Screw terminal

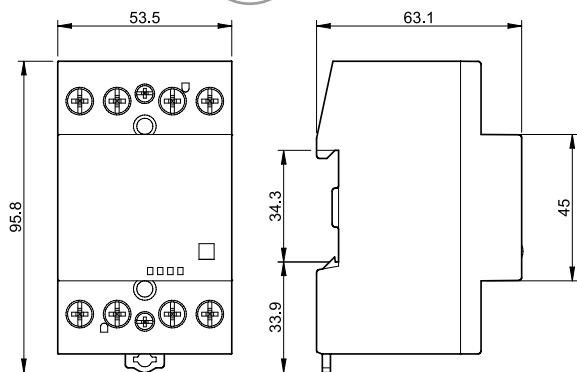

Type 22.44/22.64 + 022.63/022.65
Screw terminal

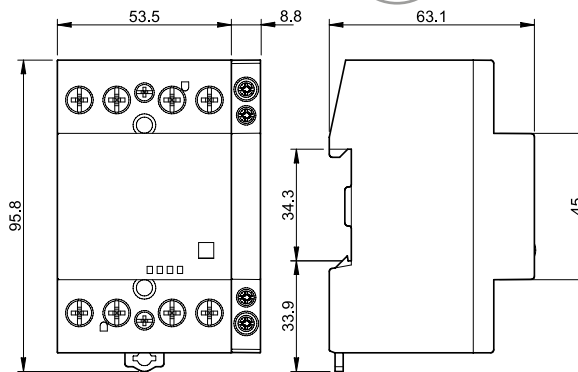

Type 022.33/022.35
Screw terminal

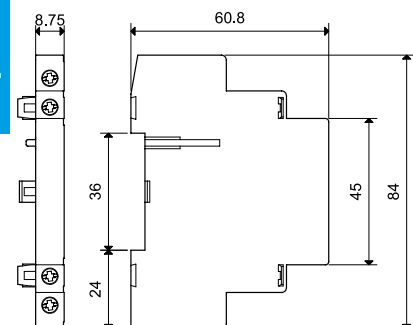

Type 022.63/022.65
Screw terminal

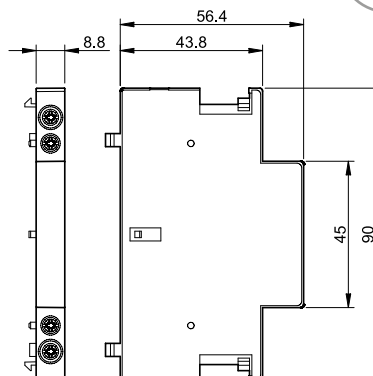

Auxiliary modules	022.33	022.35	022.63	022.65
Mechanically linked contacts according to Annex L of EN 60947-5-1				
Type of contactor	Type 22.32 Type 22.34		Type 22.44 Type 22.64	
Contact specification	2 NO		1 NO + 1 NC	
Contact configuration	2 NO		1 NO + 1 NC	
Conventional free air thermal current I_{th}	A 6		6	
Rated power AC15 (230 V)	VA 700		700	
Electrical life at rated load	cycles $30 \cdot 10^3$		$30 \cdot 10^3$	
Minimum switching load	mW (V/mA) 1000 (10/10)		1000 (10/10)	
Contact material	AgNi		AgNi	
Short circuit protection				
Rated conditional short circuit current	kA 1		1	
Back-up fuse	A 6 (gL/gG type)		6 (gL/gG type)	
Terminals	Solid and stranded cable		Solid and stranded cable	
Max. wire size	mm ² 1 x 4 / 2 x 2.5 AWG 1 x 12 / 2 x 14		1 x 2.5 1 x 14	
Min. wire size	mm ² 1 x 0.2 AWG 1 x 24		1 x 1 1 x 18	
Screw torque	Nm 0.6		0.6	
Wire strip length	mm 9		9	
Power lost to the environment				
without contact current	W —		—	
with rated current	W 0.5		0.5	
Approvals (according to type)	CE EAC RINA cUL US		CE EAC cUL US	

NOTE: It is not possible to assembly the auxiliary module on 22.32.0.xxx.x4x0 (2 NC versions).



22.32 + 022.33/022.35



22.44 + 022.63/022.65







22.34 + 022.33/022.35

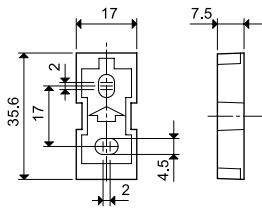

22.64 + 022.63/022.65

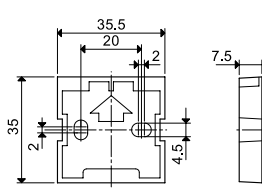
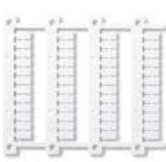
Accessories

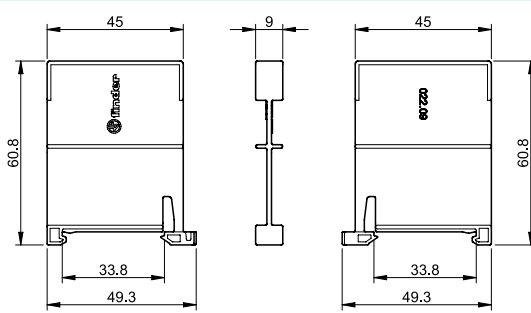
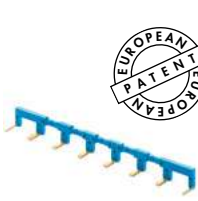
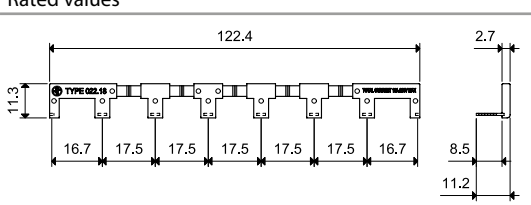
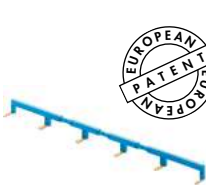
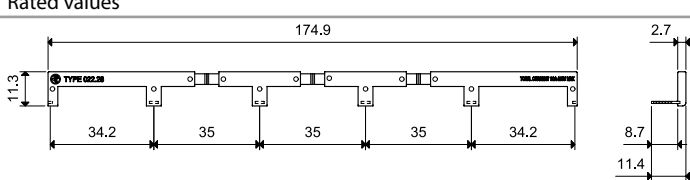
 <p>020.01</p>	<p>Adaptor for panel mounting (for 22.32 type), plastic, 17.5 mm wide</p> 	<p>020.01</p>
 <p>011.01</p>	<p>Adaptor for panel mounting (for 22.34 type), plastic, 35 mm wide</p> 	<p>011.01</p>
 <p>060.48</p>	<p>Sheet of marker tags (CEMBRE Thermal transfer printers) for all relays (48 tags), 6 x 12 mm</p>	<p>060.48</p>
 <p>019.01</p>	<p>Identification tag, plastic, 1 tag, 17x25.5 mm</p>	<p>019.01</p>
 <p>022.09</p>	<p>Separator for rail mounting, plastic, 9 mm wide</p> 	<p>022.09</p>
 <p>022.18</p>	<p>8-way jumper link for type 22.32, 17.5 mm wide</p> <p>Rated values</p> 	<p>022.18 (blue) 10 A - 250 V</p>
 <p>022.26</p>	<p>6-way jumper link for type 22.34, 35 mm wide</p> <p>Rated values</p> 	<p>022.26 (blue) 10 A - 250 V</p>



Thermostat



Comfort



Energy savings



Ecological



Flexibility



Heating and cooling



Building automation



Digital “touch” thermostat

- Touch display with guided programming
- Bright backlighting
- ECO1 power-saving feature, supervisory control and PIN code
- Programmable with two operational temperature levels
- Functions: frost protection, pump anti-seizure and calibration functions
- Summer/Winter switch
- 2 level security - simple touch screen blocking or full 3-digit PIN lock
- Remote control input to change temperature or for switching On/Off
- Acoustic signal to confirm key operation
- Complete with adaptor for following frames:
 - ABB series Chiara
 - ABB series Mylos
 - Ave series S44
 - BTicino series Axolute
 - BTicino series Light
 - BTicino series Light tech
 - BTicino series Living
 - BTicino series Livinglight
 - BTicino series Matix
 - Gewiss series Chorus
 - Vimar series Eikon
 - Vimar series Eikon Evo
 - Vimar series Idea
 - Vimar series Plana
 - Vimar series Arkè
 - Adapter type 01C.51 for BTicino series Livinglight Air switch plates

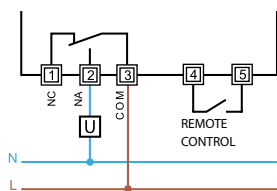

Wiring diagram

1T.51

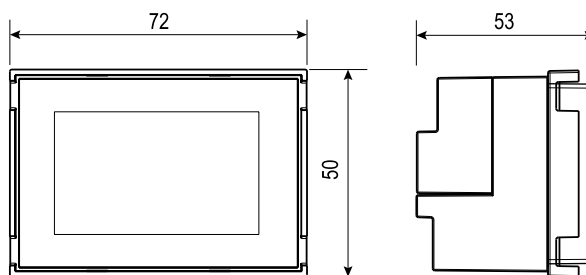

Colour	
White	1T.51.9.003.0000
Black	1T.51.9.003.2000
Technical features	
Sensing element	NTC
Supply	2 batteries 1.5 V AAA
Contact configuration	1 CO (SPDT)
Contact rating	5 A/250 V AC
Display range	0 - 50 °C
Temperature setting range	+5...+37 °C
Temperature differential	0.1...0.9 °C
Temperature rate of change	—
Nighttime set-back	—
Independently set temperature levels	2
Thermostat lock	Code
Protection category	IP20
Mounting	Recess (3 module box)
Display resolution	0.1 °C
Accuracy at +20 °C	+/-0.5 °C
Frost Protection	+2...+8 °C
Energy saving function	E1
Push buttons	Touch screen
Supervisory control	YES
Back-light display	YES
Approvals (according to type)	CE EAC

Digital room thermostat

- Independently set temperatures for Day and Night
- Temperature range (+5...+37)°C
- Supply voltage: 3 V DC
(2 batteries 1.5 V DC AAA)
- Thermostat lock
- Functions: OFF (with Frost protection)/
Summer/Winter
- Frost protection range (+2...+8)°C
- 1 change over 5 A/250 V AC output
- On/Off hysteresis selectable (0.2 - 0.5)°C

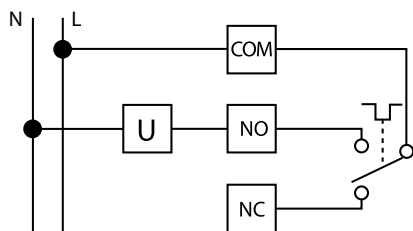

Wiring diagram

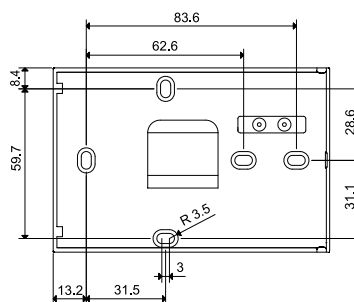
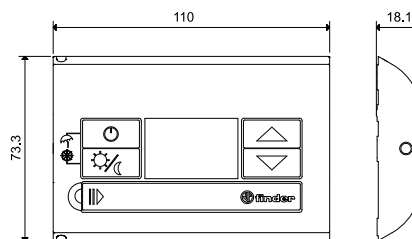
1T.31

Colour	
White	1T.31.9.003.0000
Black	1T.31.9.003.2000
Technical features	
Sensing element	NTC
Supply	2 batteries 1.5 V AAA
Contact configuration	1 CO (SPDT)
Contact rating	5 A/250 V AC
Display range	0...+50 °C
Temperature setting range	+5...+37 °C
Temperature differential	0.2 - 0.5
Temperature rate of change	—
Nighttime set-back	YES
Independently set temperature levels	2
Thermostat lock	Push buttons
Protection category	IP20
Mounting	Surface
Display resolution	0.1 °C
Accuracy at +20 °C	+/-0.5 °C
Frost Protection	+2...+8 °C
Energy saving function	—
Push buttons	Mechanical
Supervisory control	NO
Back-light display	NO
Approvals (according to type)	CE ENEC

Digital room thermostat

- Temperature regulation from 5 to 33 °C
- Supply voltage: 3 V DC
(2 batteries 1.5 V DC AAA)
- Functions: OFF (with Frost protection)/
Summer/Winter
- Programming: Day/Night (set-back by -3 °C)
- 1 change over 5 A/250 V AC output
- Temperature setting range can be restricted, by
internal mechanical blocking
- Display with:
 - Set temperature, actual temperature
 - Low battery
 - SUMMER/WINTER setting active
 - Heater/Air-conditioning ON

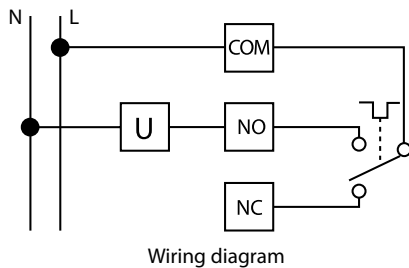

1T.41

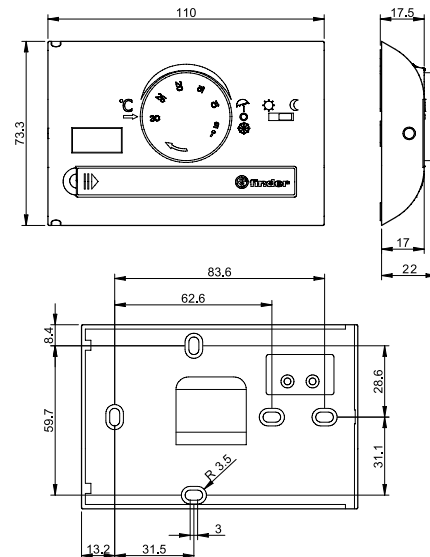

Colour

White

1T.41.9.003.0000

Black

1T.41.9.003.2000

Technical features

Sensing element

NTC

Supply

2 batteries 1.5 V AAA

Contact configuration

1 CO (SPDT)

Contact rating

5 A/250 V AC

Display range

0...+50 °C

Temperature setting range

+8...+30 °C (reducing night: **Winter** +5...+27 °C/**Summer** +11...+33 °C)

Temperature differential

0.3

Temperature rate of change

—

Nighttime set-back

YES

Independently set temperature levels

—

Thermostat lock

Mechanical

Protection category

IP20

Mounting

Surface

Display resolution

0.1 °C

Accuracy at +20 °C

+/-0.5 °C

Frost Protection

5 °C

Energy saving function

—

Push buttons

Mechanical

Supervisory control

NO

Back-light display

NO

Approvals (according to type)

CE EAC

Room thermostat

- Temperature regulation (+7...+30)°C
- System operating - indicator light

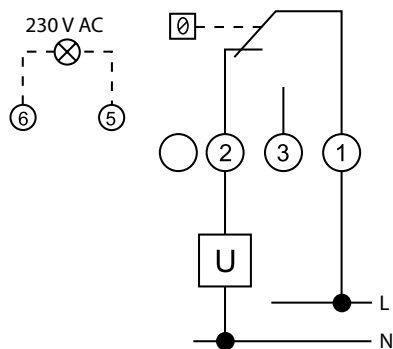

Wiring diagram

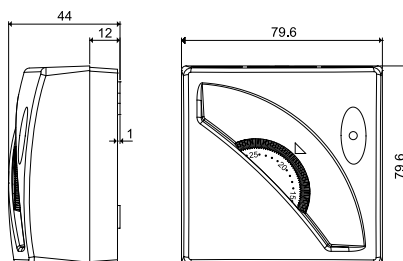
1T.01.0**Colour**

White

1T.01.0

Technical features

Sensing element	Gas bulb
Supply	—
Contact configuration	1 CO (SPDT)
Contact rating	16 A/250 V AC
Display range	—
Temperature setting range	+7...+30 °C
Temperature differential	0.4 - 0.8 °C
Temperature rate of change	1 °C/15 min
Nighttime set-back	—
Independently set temperature levels	—
Thermostat lock	Mechanical
Protection category	IP20
Mounting	Surface
Display resolution	—
Accuracy at +20 °C	—
Frost Protection	—
Energy saving function	—
Push buttons	—
Supervisory control	NO
Back-light display	NO

Approvals (according to type)



Room thermostat ON/OFF

- Switch ON/OFF
- Temperature regulation (+7...+30)°C
- System operating - indicator light

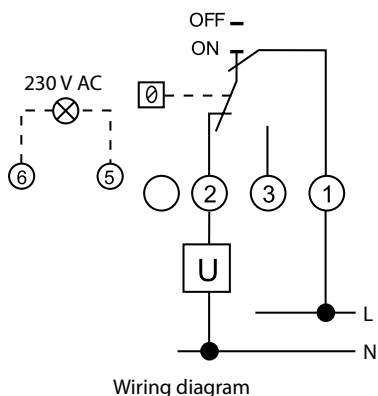

1T.01.1

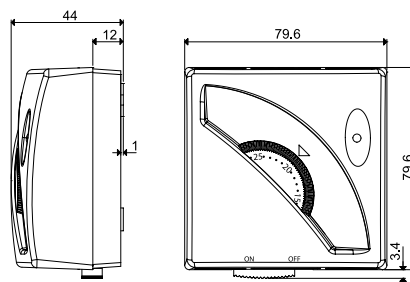

Colour	
White	1T.01.1
Technical features	
Sensing element	Gas bulb
Supply	—
Contact configuration	1 CO (SPDT)
Contact rating	16 A/250 V AC
Display range	—
Temperature setting range	+7...+30 °C
Temperature differential	0.4 - 0.8 °C
Temperature rate of change	1 °C/15 min
Nighttime set-back	—
Independently set temperature levels	—
Thermostat lock	Mechanical
Protection category	IP20
Mounting	Surface
Display resolution	—
Accuracy at +20 °C	—
Frost Protection	—
Energy saving function	—
Push buttons	—
Supervisory control	NO
Back-light display	NO
Approvals (according to type)	CE EAC

Room thermostat SUMMER/WINTER

- Switch SUMMER/WINTER
- Temperature regulation (+7...+30)°C
- System operating - indicator light

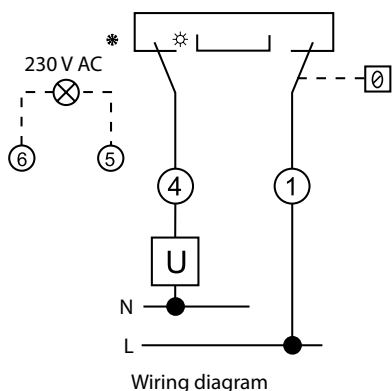

1T.01.2

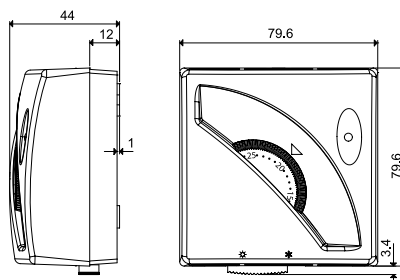

Colour	
White	1T.01.2
Technical features	
Sensing element	Gas bulb
Supply	—
Contact configuration	1 CO (SPDT)
Contact rating	16 A/250 V AC
Display range	—
Temperature setting range	+7...+30 °C
Temperature differential	0.4 - 0.8 °C
Temperature rate of change	1 °C/15 min
Nighttime set-back	—
Independently set temperature levels	—
Thermostat lock	Mechanical
Protection category	IP20
Mounting	Surface
Display resolution	—
Accuracy at +20 °C	—
Frost Protection	—
Energy saving function	—
Push buttons	—
Supervisory control	NO
Back-light display	NO
Approvals (according to type)	CE ENEC



finder[®]
SWITCH TO THE FUTURE

Digital chronothermostats



Comfort



Energy
savings



Ecological



Flexibility



Heating and
cooling



Building
automation



1C
SERIES

Digital room

- Touch display with guided programming
- Can be programmed via smartphones with NFC communication
- Bright backlighting
- ECO1 & ECO2 power-saving features, supervisory control and PIN code
- 3 programmable temperature thresholds
- Minimum programming interval 30 minutes
- Functions: party program, recalibration of displayed temperature, manual timed with calendar setting, frost protection, pump anti-seizure and calibration functions
- Summer/Winter switch
- 2 level security - simple touch screen blocking or full 3-digit PIN lock
- NFC programming with dedicated APP
- Calendar with automatic leap year & daylight-saving updates
- Visual and audible confirmation of key and function entry
- Surface mounting over 3 module wall box (eg. type 503)

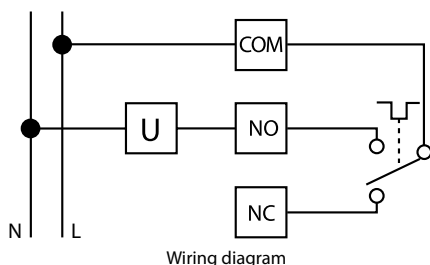

1C.81

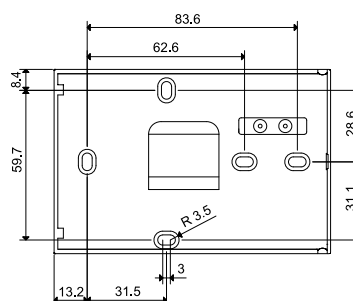
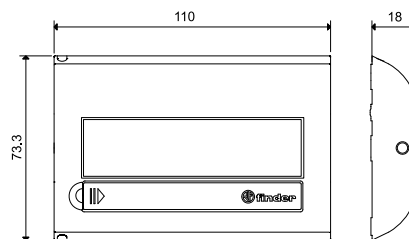

Colour

- White RAL 9010
- Metallic Anthracite

Weekly Program

- 1C.81.9.003.0107
- 1C.81.9.003.2107

Technical features

Sensing element	NTC
Supply	2 batteries 1.5 V AAA
Contact configuration	1 CO (SPDT)
Contact rating	5 A/250 V AC
Display range	0...+50 °C
Temperature setting range	+5...+37 °C
Temperature differential	0.1...0.9 °C
Temperature rate of change	—
Nighttime set-back	—
Independently set temperature levels	3
Thermostat lock	Code
Protection category	IP 20
Mounting	Surface
Display resolution	0.1 °C
Accuracy at +20 °C	+/-0.5 °C
Frost Protection	+2...+8 °C
Weekly/Daily	Weekly
Minimum programming interval	30 min
Energy saving function	E1 + E2
Push buttons	Touch screen
Supervisory control	YES
Back-light display	YES
Communications	NFC
APP programming	YES
Approvals (according to type)	CE EAC

Programming modes with NFC



Android, Google Play and the Google Play logo are trademarks of Google Inc.

NFC: Leave it to your smartphone and programming your chronothermostat is done!



Finder Clima



New user App for simple, guided programming



Download user App **Finder Clima**

Finder Clima makes it easy to programme the 1C.81 chronothermostat with your smartphone by using NFC (Near Field Communication) technology. You can assign a name to the different chronothermostats in your house and save the relative programming on your telephone. When you place your smartphone against the chronothermostat, the programming is immediately transferred. With the application, it is possible to programme the temperatures on a weekly basis, change the temperature programming for 24 hours, suspend the programme when you go on holiday, and regulate the temperature comfort levels.

Finder Clima will guide you step-by-step during the whole procedure!

Digital room chronothermostat touch basic

- Touch display with guided programming
- Ultra-compact design
- 3 programmable temperature levels
- Functions: party program, recalibration of displayed temperature, manual timed with calendar setting, frost protection, pump anti-seizure and calibration functions
- Summer/Winter switch
- Simple touch screen blocking or full 3-digit PIN lock
- Calendar with automatic leap year & daylight-saving updates
- Partial display block or full lock with PIN code
- Multi-function and multi-touch buttons
- Surface mounting over 3 module wall box (eg. type 503)

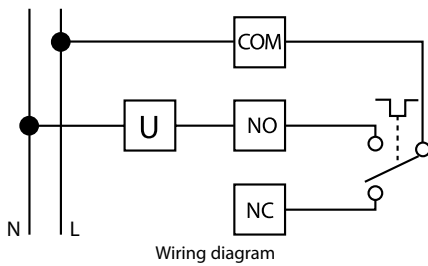

NEW 1C.71

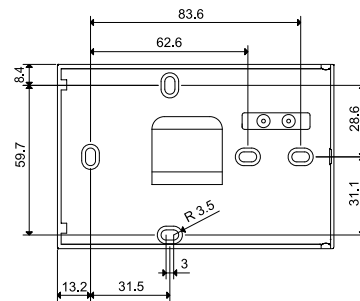
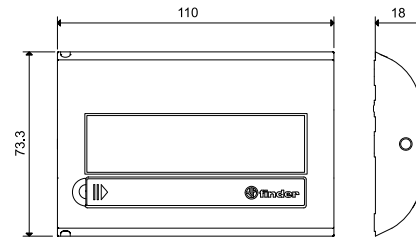

Colour	Weekly Program
White	1C.71.9.003.0007
Black	1C.71.9.003.2007
Technical features	
Sensing element	NTC
Supply	2 batteries 1.5 V AAA
Contact configuration	1 CO (SPDT)
Contact rating	5 A/250 V AC
Display range	0...+50 °C
Temperature setting range	+5...+37 °C
Temperature differential	0.1...0.9 °C
Temperature rate of change	—
Nighttime set-back	—
Independently set temperature levels	3
Thermostat lock	Code
Protection category	IP 20
Mounting	Surface
Display resolution	0.1 °C
Accuracy at +20 °C	+/-0.5 °C
Frost Protection	+2...+8 °C
Weekly/Daily	Weekly
Minimum programming interval	1 hour
Energy saving function	—
Push buttons	Touch screen
Supervisory control	NO
Back-light display	NO
Communications	—
APP programming	—
Approvals (according to type)	CE EAC

Digital “touch slide” chronothermostat

- Touch display with guided programming
- Chronothermostat “touch slide” ultrathin 17 mm only with wide display
- Easy to use
- Summer/Winter switch
- 24 point for temperature setting
- Basic display lock or advanced with PIN, with storage of all settings
- Visual and audible confirmation of key and function entry
- Minimum interval setting 15 minutes
- The weekly function allows each day to be set to, automatic mode, hand mode, or OFF
- Calibration function
- The thermostat can display, or be controlled by the external temperature using an external sensor (optional accessory)
- Input for remote control
- Dynamic icons
- Surface mounting over 3 module wall box (eg. type 503)

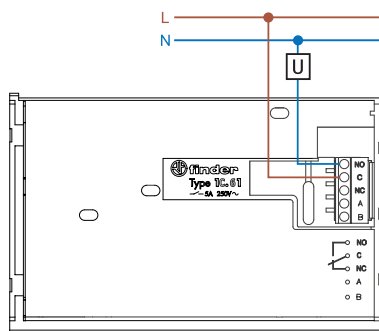

Wiring diagram

1C.61

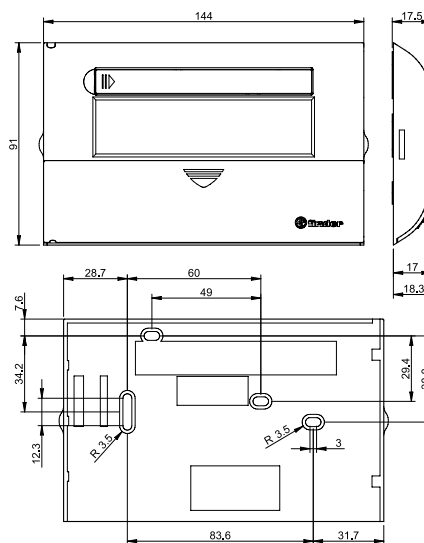

Colour	Daily Program
White RAL 9010	1C.61.9.003.0101
Metallic Anthracite	1C.61.9.003.2101
Technical features	
Sensing element	NTC
Supply	2 batteries 1.5 V AAA
Contact configuration	1 CO (SPDT)
Contact rating	5 A/250 V AC
Display range	0...+50 °C
Temperature setting range	+5...+37 °C (with sliders: winter +6...+24 °C/ summer +18...+30 °C)/-20...+90 °C (with external sensor)
Temperature differential	0.1...0.9 °C
Temperature rate of change	—
Nighttime set-back	—
Independently set temperature levels	Slide
Thermostat lock	Code
Protection category	IP 20
Mounting	Surface
Display resolution	0.1 °C
Accuracy at +20 °C	+/-0.5 °C
Frost Protection	+2...+8 °C
Weekly/Daily	Daily + 7 Daily
Minimum programming interval	1 h or 15 minutes - daily/weekly (weekly: only Auto, Manual and OFF mode)
Energy saving function	—
Push buttons	Touch screen
Supervisory control	NO
Back-light display	YES
Communications	—
APP programming	—
Approvals (according to type)	CE ENEC

Accessories



01C.61

External temperature sensor	01C.61
Sensing range	(-20...+90)°C
Resolution	0.1 °C (-9.9...+90)°C
	1 °C (-10...-20)°C
Maximum cable length	m 20
Degree of protection	IP 54

The 01C.61 is used to sense the temperature at a location external to the 1C.61 chronothermostat. The 1C.61 can either; display the external temperature (and regulate to its internal sensor), or display & regulate to the external sensor temperature. The 01C.61 sensor communicates with the 1C.61 chronothermostat through a dedicated digital system. This is the only sensor that can be used.

Outline drawings

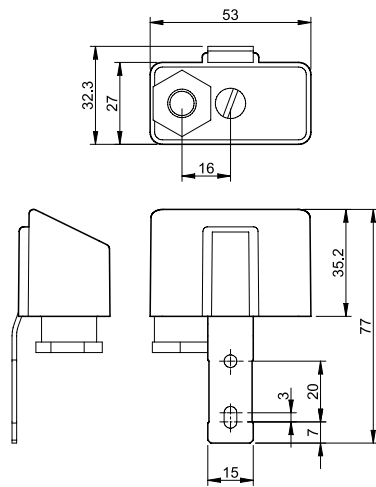

Wiring diagrams

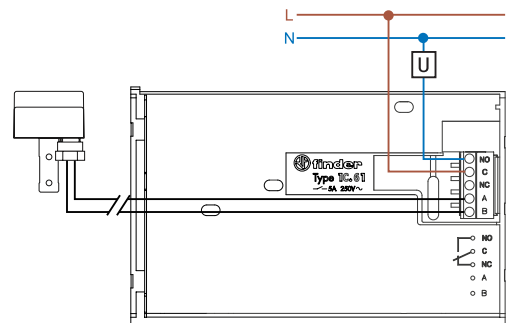

Digital "touch" chronothermostat

- Easy to use
- TOUCH SCREEN Programmable Room Thermostat weekly programmable version
- Calendar with automatic leap year & daylight-saving updates
- Summer/Winter switch
- 3 programmable temperature thresholds
- Functions: frost protection, automatic control, manual control, holiday program, pump anti-seizure function
- Visual and audible confirmation of key and function entry
- 2 level security - simple touch screen blocking or full 3-digit PIN lock
 - remote control
- Compatible with 3 module housing
- 1 contact output 5 A/250 V AC
- Complete with adaptor for following frames:
 - ABB series Chiara
 - ABB series Mylos
 - Ave series S44
 - BTicino series Axolute
 - BTicino series Light
 - BTicino series Light tech
 - BTicino series Living
 - BTicino series Livinglight
 - BTicino series Matix
 - Gewiss series Chorus
 - Vimar series Eikon
 - Vimar series Eikon Evo
 - Vimar series Idea
 - Vimar series Plana
 - Vimar series Arkè
 - Adapter type 01C.51 for BTicino serie Livinglight Air cover plates

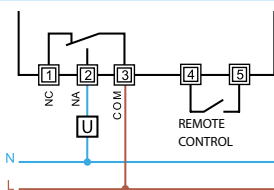

Wiring diagram

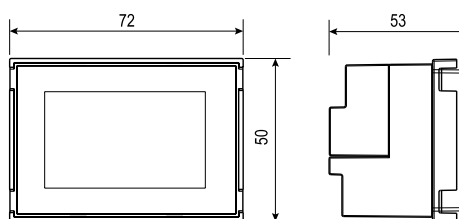
1C.51**Colour**

White	1C.51.9.003.0007
Black	1C.51.9.003.2007

Technical features

Sensing element	NTC
Supply	2 batteries 1.5 V AAA
Contact configuration	1 CO (SPDT)
Contact rating	5 A/250 V AC
Display range	0...+50 °C
Temperature setting range	+5...+37 °C
Temperature differential	0.1...0.9 °C
Temperature rate of change	—
Nighttime set-back	—
Independently set temperature levels	3
Thermostat lock	Code
Protection category	IP 20
Mounting	Recess (3 module box)
Display resolution	0.1 °C
Accuracy at +20 °C	+/-0.5 °C
Frost Protection	+2...+8 °C
Weekly/Daily	Weekly
Minimum programming interval	1 h
Energy saving function	—
Push buttons	Touch screen
Supervisory control	NO
Back-light display	YES
Communications	—
APP programming	—
Approvals (according to type)	CE ENEC

Terms	Page	col.
Reference standards and values	II	1
Operating & installation conditions	II	1
Coil operating range	II	1
Excessive peak voltage limiting	II	1
Residual current	II	1
Ambient temperature	II	1
Condensation	II	1
Installed orientation	II	1
RC contact suppression	II	1
Guidelines for automatic flow solder processes	II	2
Relay mounting	II	2
Flux application	II	2
Preheating	II	2
Soldering	II	2
Cleaning	II	2
Terminology & definitions	III	1
Terminal marking	III	1
Contact specification	III	1
Contact Set	III	1
Single contact	III	1
Twin/Bifurcated contact	III	1
Double break contact	III	1
Micro interruption	III	1
Micro disconnection	III	1
Full disconnection	III	2
Rated current	III	2
Maximum peak current	III	2
Rated switching voltage	III	2
Maximum switching voltage	III	2
Rated load AC1	III	2
Rated load AC15	III	2
Single-phase motor rating	III	2
Nominal lamp ratings	III	2
Breaking capacity DC1	III	2
Minimum switching load	III	2
Electric life tests	IV	1
Electrical life "F-chart"	IV	1
Load reduction factor versus Cos φ	IV	1
Capacitor start motors	VII	1, 2
Three-phase alternating current loads	IX	1
Three-phase motors	IX	1
Switching different voltages within a relay	IX	2
Contact resistance	IX	2
Contact categories according to EN 61810-7	IX	2
Coil specification	X	1
Nominal voltage	X	1
Rated power	X	1
Operating range	X	1
Non-operate voltage	X	1
Minimum Pick-up voltage (Operate voltage)	X	1
Maximum permitted voltage	X	1
Holding voltage (Non-release voltage)	X	1
Must drop-out voltage (Must release voltage)	X	1
Coil Resistance	X	1
Rated coil consumption	X	1
Thermal tests	X	2
Monostable relay	X	2
Bistable relay	X	2
Latching relay	X	2
Remanence relay	X	2
Insulation	X	2
EN/IEC 61810-1 Relay standard	X	2
Relay function and Isolation	X	2
Specifying isolation levels	XI	1
Insulation coordination	XI	1
Nominal voltage of supply system	XI	2
Rated Insulation Voltage	XI	2
Dielectric strength	XI	2
Insulation Group	XII	1
SELV, PELV and Safe separation	XII	1
The SELV system	XII	1
The PELV system	XII	1
General technical data	XII	2
Cycle	XII	2
Period	XII	2
Duty factor (DF)	XII	2
Continuous operation	XII	2
Mechanical life	XII	2
Operate time	XII	2
Release time	XII	2
Bounce time	XII	2
Ambient temperature	XII	2
Ambient temperature range	XIII	1
Storage temperature range	XIII	1
Environmental protection	XIII	1
Protection category	XIII	1

Vibration resistance	XIII	1		
Shock resistance	XIII	1		
Installed orientation	XIII	2		
Power lost to the environment	XIII	2		
Recommended distance between relays mounted on printed circuit boards	XIII	2		
Torque	XIII	2		
Minimum Wire size	XIII	2		
Max. wire size	XIII	2		
Terminating more than one wire	XIII	2		
Box clamp	XIII	2		
Plate clamp	XIII	2		
Screwless terminal (Spring clamp)	XIII	2		
Push-in terminal	XIII	2		
SSR - Solid State Relay	XIII	2		
SSR Solid State Relay	XIII	2		
Opto-coupler	XIII	2		
Switching voltage range	XIV	1		
Minimum switching current	XIV	1		
Control current	XIV	1		
Maximum blocking voltage	XIV	1		
Relay with forcibly guided (mechanically linked) contacts, or safety relay	XIV	1		
Monitoring and Measuring relays	XIV	1		
Supply voltage monitoring	XIV	1		
3-phase asymmetry monitoring	XIV	1		
Detection level	XIV	1		
Switch-on lock-out time	XIV	1		
Start delay (T2)	XIV	2		
Switch-off time	XIV	2		
Trip on-delay	XIV	2		
Run-on time	XIV	2		
Reaction time	XIV	2		
Fault memory	XIV	2		
Fault memory - status retained on power down	XIV	2		
Switch-ON hysteresis	XIV	2		
Thermistor temperature sensing	XIV	2		
Level control relay	XIV	2		
Electrode voltage	XIV	2		
Electrode current	XIV	2		
Max. sensitivity	XIV	2		
Sensitivity, fixed or adjustable	XIV	2		
Positive safety logic	XV	1		
Timers	XV	1		
Specified time range	XV	1		
Repeatability	XV	1		
Recovery time	XV	1		
Minimum control impulse	XV	1		
Setting accuracy	XV	1		
Light dependent relays	XV	1		
Threshold setting	XV	1		
Delay time	XV	1		
Time switches	XV	1		
1 or 2 pole output types	XV	1		
Type of time switch	XV	1		
Programs	XV	1		
Minimum interval setting	XV	1		
Power back-up	XV	1		
Step relays and staircase timers	XV	2		
Minimum/Maximum impulse duration	XV	2		
Max. number of illuminated push-buttons	XV	2		
Glow wire conformity according to EN 60335-1	XV	2		
EMC (ElectroMagnetic Compatibility) Standards	XV	2		
Burst (fast transients)	XVI	1		
Surge (voltage pulses)	XVI	1		
EMC rules	XVI	2		
Reliability (MTTF & MTBF for equipment)	XVI	2		
MTTF	XVI	2		
MTBF	XVI	2		
B ₁₀ - Statistical 10% fractile of lifetime	XVI	2		
The RoHS & WEEE directives	XVI	2		
S I L and P L categories	XVII	2		
Certifications and Quality Approvals	XVIII	—		
Tables	TABLE 1	Contact load classifications	IV	2
	TABLE 2.1	UL Certified products ratings	V	—
	TABLE 2.2	UL Certified products ratings	VII	—
	TABLE 2.3	UL Certified sockets ratings	VIII	—
	TABLE 3	Motor ratings v relay series	IX	1
	TABLE 4	Contact categories	IX	2
	TABLE 5	Contact materials characteristics	IX	2
	TABLE 6	Rated impulse voltage	XI	2
	TABLE 7	Pollution degree	XI	2

Reference standards and values

Unless expressly indicated otherwise, the products shown in this catalogue are designed and manufactured according to the requirements of the following European and International Standards:

- **EN 61810-1**, **EN 61810-2**, **EN 61810-7** for electromechanical elementary relays
- **EN 61810-3** for relays with forcibly guided contacts
- **EN 61812-1** for timers
- **EN 60669-1** and **EN 60669-2-2** for electromechanical step relays
- **EN 60669-1** and **EN 60669-2-1** for light-dependent relays, electronic step relays, light dimmers, staircase switches, movement detectors and monitoring relays.

Other important standards, often used as reference for specific applications, are:

- **EN 60335-1** and **EN 60730-1** for domestic appliances
- **EN 50178** for industrial electronic equipments

According to EN 61810-1, all technical data is specified under standard conditions of 23 °C ambient temperature, 96 kPa pressure, 50% humidity, clean air and 50 Hz frequency. The tolerance for coil resistance, nominal absorption and rated power values is $\pm 10\%$.

Unless expressly indicated otherwise, the standard tolerances for mechanical drawings are ± 0.1 mm.

Operating & installation conditions

Coil operating range

In general, Finder relays will operate over the full specified temperature range, according to:

- Class 1 - 80% to 110% of nominal coil voltage, or
- Class 2 - 85% to 110% of nominal coil voltage.

Outside the above Classes, coil operation is permitted according to the limits shown in the appropriate "R" chart.

Unless expressly indicated otherwise, all relays are suitable for 100% Duty Cycle (continuous energisation) and all AC coil relays are suitable for 50 and 60 Hz frequency.

Excessive peak voltage limiting

Overvoltage protection (varistor for AC, diode for DC) is recommended in parallel with the coil for nominal voltages ≥ 110 V for the relays of 40, 41, 44, 46 series.

Residual current

When AC relay coils are controlled via a proximity switch, or via cables having length > 10 m, the use of a "residual current bypass" module is recommended, or alternatively, fit a resistor of 62 kOhm/1 watt in parallel with the coil.

Ambient temperature

The Ambient temperature as specified in the relevant specification and "R" chart relates to the immediate environment in which the component is situated, as this may be greater than the ambient temperature in which the equipment is located. Refer to page XII for more detail.

Condensation

Environmental conditions causing condensation or ice formation in the relay are not permitted.

Installed orientation

The component's specification is unaffected (unless expressly stated otherwise) by its orientation, (provided it is properly retained, eg by a retaining clip in the case of socket mounted relays).

RC contact suppression

If a resistor/capacitor network is placed across a contact to suppress arcing, it should be ensured that when the contact is open, the leakage current through the RC network does not give rise to a residual voltage across the load (typically the coil of another relay or solenoid) any greater than 10% of the load's nominal voltage - otherwise, the load may hum or vibrate, and reliability can be affected. Also, the use of an RC network across the contact will destroy the isolation normally afforded by the contact (in the open position).

Guidelines for automatic flow solder processes

In general, an automatic flow solder process consists of the following stages:

Relay mounting

Ensure that the relay terminals are straight and enter the PC board perpendicular to the PC board. For each relay, the catalogue illustrates the necessary PC board hole pattern (copper side view). Because of the weight of the relay, a plated through hole printed circuit board is recommended to ensure a secure fixation.

Flux application

This is a particularly delicate process. If the relay is not sealed, flux may penetrate the relay due to capillary forces, changing its performance and functionality.

Whether using foam or spray fluxing methods, ensure that flux is applied sparingly and evenly and does not flood through to the component side of the PC board.

By following the above precautions, and assuming the use of alcohol or water based fluxes, it is possible to satisfactorily use relays with protection category RT II.

Preheating

Set the preheat time and heat to just achieve the effective evaporation of the flux, taking care not to exceed a component side temperature of 100 °C (212 °F).

Soldering

Set the height of the molten solder wave such that the PC board is not flooded with solder. Ensure the solder temperature and time are kept to 260 °C (500 °F) and 3 seconds maximum.

Cleaning

The use of modern "no-clean" flux avoids the necessity of washing the PC board. In special cases where the PC board must be washed the use of wash-tight relays (option xxx1 - RT III) is strongly recommended. After cleaning it is suggested to break the pin on the relay cover. This is necessary to guarantee the electrical life at maximum load as quoted in the catalogue; otherwise ozone generated inside the relay (dependent on the switching load and frequency) will reduce the electrical life. Even so, avoid washing the relay itself, particularly with aggressive solvents or in washing cycles using low temperature water, as this may cause thermal shock to the PC board components. The user should establish compatibility between his cleaning fluid and the relay plastics.

Terminology & definitions

All the following terms used in the catalogue are commonly used in technical language. However, occasionally, National, European or International Standards may prescribe the use of different terms, in which case these will be mentioned in the appropriate descriptions that follow.

Terminal marking

European Standard EN 50005 recommends the following numbering for the marking of relay terminals:

- .1 for common contact terminals (e.g. 11, 21, 31...)
- .2 for NC contact terminals (e.g. 12, 22, 32...)
- .4 for NO contact terminals (e.g. 14, 24, 34...)
- A1 and A2 for coil terminals
- B1, B2, B3 etc. for Signal inputs
- Z1 & Z2 for potentiometer or sensor connection

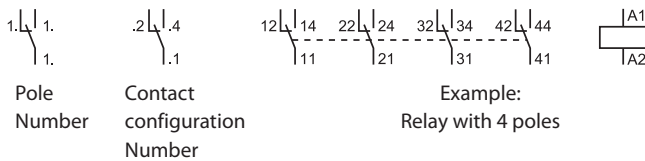

For delayed contacts of timers the numbering will be:

- .5 for common contact terminals (e.g. 15, 25,...)
- .6 for NC contact terminals (e.g. 16, 26,...)
- .8 for NO contact terminals (e.g. 18, 28,...)

IEC 67 and American standards prescribe:

progressive numbering for terminals (1,2,3,...13,14,...) and sometimes A and B for coil terminals.

Contact specification

Symbol	Configuration	EU	D	GB	USA
	Make contact (Normally Open)	NO	S	A	SPST-NO DPST-NO nPST-NO
	Break contact (Normally Closed)	NC	Ö	B	SPST-NO DPST-NO nPST-NO
	Changeover	CO	W	C	SPDT DPDT nPDT

n = number of poles (3,4,...), S = 1 and D = 2

Contact Set

The contact set comprises all the contacts within a relay.

Single contact

A contact with only one point of contact.

Twin/Bifurcated contact

A contact with two points of contact, which are effectively in parallel with each other. Very effective for switching small contact loads such as analogue, transducer, low signal or PLC input circuits.

Double break contact

A contact comprising two points of contact in series with each other. Particularly effective for switching DC loads. The same effect can be achieved by wiring two single contacts in series.

Micro interruption

Interruption of a circuit, without any specific requirements for distance or dielectric strength across the contact gap. All Finder relays comply or exceed this.

Micro disconnection

Adequate contact separation in at least one contact so as to provide functional safety. A dielectric strength requirement must be achieved across the contact gap. All Finder relays comply with this class of disconnection.

Full disconnection

Contact separation for the disconnection of conductors so as to provide the equivalent of basic insulation between those parts intended to be disconnected. There are requirements for both the dielectric strength and the dimensioning of the contact gap. Finder relays types 45.91, 56.xx - 0300, 62.xx - 0300 And 65.x1 - 0300 comply with this category of disconnection.

Rated current

This coincides with the *Limiting continuous current* - the highest current that a contact can continuously carry within the prescribed temperature limits. It also coincides with the *Limiting cycling capacity*, i.e. the maximum current that a contact is capable of making and breaking under specified conditions. In virtually all cases the Rated current is also the current that, when associated with the Rated switching voltage, gives rise to the Rated load (AC1). (The exception being the 30 series relay).

Maximum peak current

The highest value of inrush current (≤ 0.5 seconds) that a contact can make and cycle (duty cycle ≤ 0.1) without undergoing any permanent degradation of its characteristics due to generated heat. It also coincides with the *Limiting making capacity*.

Rated switching voltage

This is the switching voltage that when associated with the Rated current gives rise to the Rated load (AC1). The Rated load is used as the reference load for electrical life tests.

Maximum switching voltage

This represents the maximum nominal voltage that the contacts are able to switch and for the relay to meet the insulation and design requirements called for by the insulation coordination standards.

Rated load AC1

The maximum AC resistive load (in VA) that a contact can make, carry and break repeatedly, according to classification AC1 (see Table 1). It is the product of rated current and rated voltage, and is used as the reference load for electrical life tests.

Rated load AC15

The maximum AC inductive load (in VA) that a contact can make, carry and break repeatedly, according to classification AC15 (see Table 1), called "AC inductive load" in EN 61810-1:2008, Annex B.

Single-phase motor rating

The nominal value of motor power that a relay can switch.

(The figures are given in kW; the horsepower rating can be calculated by multiplying the kW value by 1.34 i.e. 0.37 kW = 0.5 HP).

Note: "inching" or "plugging" is not permitted.

If reversing motor direction, always allow an intermediate break of > 300 ms, otherwise an excessive inrush peak current (caused from change of polarity of motor capacitor) may occur, causing contact welding.

Nominal lamp ratings

Lamp ratings for 230 V AC supply for:

- Incandescent (tungsten filament) lamps
- Standard and halogen filled types
- Fluorescent lamps without power factor compensation
- Fluorescent lamps compensated to $\cos \varphi \geq 0.9$ (using conventional power factor correction capacitors)

For other lamp types, such as HID, or Electronic Ballast driven fluorescent lamp loads - please enquire.

Breaking capacity DC1

The maximum value of DC resistive current that a contact can make, carry and break repeatedly, according to classification DC1 (see Table 1).

Minimum switching load

The minimum values of power, voltage and current that a contact can reliably switch. For example, if minimum values are 300 mW, 5 V/5 mA:

- with 5 V the current must be at least 60 mA;
- with 24 V the current must be at least 12.5 mA;
- with 5 mA the voltage must be at least 60 V.

For gold contact variants, loads no less than 50 mW, 5 V/2 mA are suggested. With 2 gold contacts in parallel, it is possible to switch 1 mW, 0.1 V/1 mA.

Electric life tests

The Electrical life at rated load AC1; as specified in the Technical data, represents the life expectancy for an AC resistive load at rated current and 250 V.

(This value can be used as the relay B10 Value; see “Electrical life “F-chart” and “Reliability” sections).

Electrical life “F-chart”

The “Electrical life (AC) v contact current” chart indicates the life expectancy for an AC resistive load for different values of contact current. Some charts also indicate the results of electrical life tests for Inductive AC loads with a power factor of $\text{Cos } \varphi = 0.4$ (applicable for both the contact closing and opening).

In general, the reference load voltage applicable to these life expectancy charts is $U_n = 250 \text{ V AC}$. However, the life indicated can also be assumed to be approximately valid for voltages between 125 V to 277 V. Where the life expectancy chart shows a curve for 440 V, the life indicated can also be assumed to be approximately valid for voltages up to 480 V.

Note: Life, or number of cycles, from these charts can be taken as indicating the B10 statistical value for the purposes of reliability calculations. And, this value multiplied by 1.4 could be taken as an approximation to the related MCTF (Mean Cycles To Failure) figure. (Failure, in this case, refers to the contact “wear-out” mechanism that occurs at relatively high contact loads.)

Predicting life expectancy at voltages lower than 125 V:

For load voltages $< 125 \text{ V}$ (i.e. 110 or 24 V AC), the electrical life will rise significantly with decreasing voltage. (A rough estimate can be made using a multiplying factor of $250/2U_n$ and applying it to the life expectancy appropriate to the 250 V load voltage).

Estimating switching current at voltages greater than 250 V:

For load voltages higher than 250 V (but less than the maximum switching voltage specified for the relay), the maximum contact current should be limited to the Rated load AC1 divided by the voltage being considered. For example, a relay with rated current and rated load AC1 of 16 A and 4000 VA respectively, is able to switch a maximum current of 10 A at 400 V AC: the corresponding electrical life will be approximately the same as that at 16 A/250 V.

Unless otherwise specified, the following test conditions apply:

- Tests performed at the maximum ambient temperature.
- Relay coil (AC or DC) energised at rated voltage.
- Load test applied to the NO contacts.
- Switching frequency for elementary relays: 900 cycles/h with 50% duty cycle (25% for relays with rated current $> 16 \text{ A}$ and for 45.91 and 43.61 types).
- Switching frequency for step relays: 900 cycles/h for the coil, 450 cycles/h for the contact, 50% duty cycle.
- Electrical life expectancy values are valid for relays with standard contact material; data for optional materials are available on request.

Load reduction factor versus $\text{Cos } \varphi$

The load current for AC loads which comprise both an inductive and resistive component can be estimated by applying a reduction factor (k) to the resistive contact current (according to the load’s $\text{Cos } \varphi$). Such loads should not be taken as appropriate for electric motors or fluorescent lamps, where specific ratings are quoted. They are however, appropriate for inductive loads where the current and $\text{Cos } \varphi$ are substantially the same at “make” and “break”, and are also widely specified by international relay standards as reference loads for performance verification and comparison.

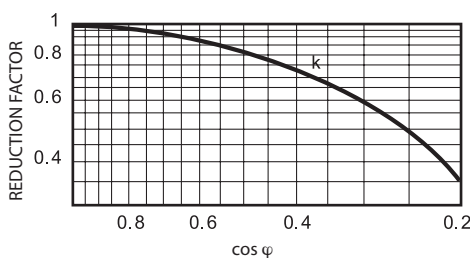

TABLE 1 Contact load classifications

(related to the utilization categories defined in EN 60947-4-1 and EN 60947-5-1)

Load classification	Supply type	Application	Switching with relay
AC1	AC single-phase AC three-phase	Resistive or slightly Inductive AC loads.	Work within the relay data.
AC3	AC single-phase AC three-phase	Starting and stopping of Squirrel cage motors. Reversing direction of rotation only after motor has stopped rotating. <u>Three-phase:</u> Motor reversal is only permitted if there is a guaranteed break of 50 ms between energisation in one direction and energisation in the other. <u>Single-phase:</u> Provision of 300 ms “dead break” time when neither relay contacts are closed - during which time the capacitor discharges harmlessly through the motor windings.	For single-phase: keep to the relay data. For three-phase: see “Three-phase motors” section.
AC4	AC three-phase	Starting, Stopping and Reversing direction of rotation of Squirrel cage motors. Jogging (Inching). Regenerative braking (Plugging).	Not possible using relays. Since, when reversing a phase connection, severe contact arcing will occur.
AC14	AC single-phase	Control of small electromagnetic loads ($< 72 \text{ VA}$), power contactors, magnetic solenoid valves, and electromagnets.	Assume a peak inrush current of approx. 6-times rated current, and keep this within the the specified “Maximum peak current” for the relay.
AC15	AC single-phase	Control of small electromagnetic loads ($> 72 \text{ VA}$), power contactors, magnetic solenoid valves, and electromagnets.	Assume a peak inrush current of approx. 10-times rated current, and keep this within specified “Maximum peak current” for the relay.
DC1	DC	Resistive loads or slightly inductive DC loads. (The switching voltage at the same current can be doubled by wiring 2 contacts in series).	Work within relay data (see the diagram “Maximum DC1 breaking capacity”).
DC13	DC		This assumes no inrush current, although the switch off over-voltage can be up to 15 times the rated voltage. An approximation of the relay rating on a DC inductive load with 40 ms L/R can be made using 50% of the DC1 rating. If a freewheeling diode is wired in parallel to the load, it can be considered the same value as DC1. See the diagram “Maximum DC1 breaking capacity”

TABLE 2.1 **US Certified products ratings**

R = Resistive / GP = General Purpose / GU = General Use / I = Inductive (cosφ 0.4) / B = Ballast / NO = NO type

Product Type	UL file No.	Ratings			Open Type Devices	Pollution degree	Max Surrounding Air Temperature	
		AC/DC	"Motor Load" Single phase					Pilot Duty
			110-120	220-240				
34.51	E106390	6 A – 250 Vac (GP)			B300 – R300	Yes	2	40 °C
40.31 – 40.51	E81856	10 A – 250 Vac (R)		1/3 Hp (250 V)	R300	Yes	/	85 °C
40.52	E81856	8 A – 250 Vac (R) 8 A – 277 Vac (GP) 8 A – 30 Vdc (GP)	1/6 Hp (4.4 FLA)	1/3 Hp (3.6 FLA)	R300	Yes	/	85 °C
40.61	E81856	15 A – 250 Vac (R)		½ Hp (250 V)	R300	Yes	/	85 °C
40.31 NEW	E81856	12 A – 277 Vac (GU) 12 A – 30 Vdc (GU)	1/3 Hp (7.2 FLA)	¾ Hp (6.9 FLA)	B300	Yes	2 or 3	85 °C
40.61 NEW	E81856	16 A – 277 Vac (GU) 16 A 30 Vdc (GU) (AgCdO) 12 A – 30 Vdc (GU) (AgNi)	1/3 Hp (7.2 FLA)	¾ Hp (6.9 FLA)	B300	Yes	2 or 3	85 °C
40.11 – 40.41	E81856	10 A – 240 Vac (R) 5 A – 240 Vac (I) 10 A – 250 Vac (GP) 8 A – 24 Vdc 0,5 A – 60 Vdc 0,2 A – 110 Vdc 0,12 A – 250 Vdc	/	½ Hp (250 V)	/	Yes	/	70 °C
41.31	E81856	12 A – 277 Vac (GU) 12 A – 277 Vac (R)	1/4 Hp (5.8 FLA)	½ Hp (4.9 FLA)	B300 – R300	Yes	2 or 3	40 or 70 °C with a minimum distance among relay of 5 mm
41.61	E81856	16 A – 277 Vac (GU-R) 8 A – 277 Vac (B)	¼ Hp (5.8 FLA)	½ Hp (4.9 FLA)	B300 – R300	Yes	2 or 3	40 or 70 °C with a minimum distance among relay of 5 mm
41.52	E81856	8 A – 277 Vac (GU-R) 8 A – 30 Vdc (GU; NO)		½ Hp (277 V) (4.1 FLA)	B300	Yes	2 or 3	40 or 70 °C with a minimum distance among relay of 5 mm
43.41	E81856	10 A – 250 Vac (GU-R) 4 A – 30 Vdc (R)	¼ Hp (5,8 FLA)	½ Hp (4,9 FLA)	B300 – R300	Yes	2 or 3	40 or 85 °C
43.61	E81856	10 A – 250 Vac (GU-R) (AgCdO) 16 A – 250 Vac (GU) (AgNi) 16 A – 250 Vac (R) (AgCdO)	¼ Hp (5.8 FLA) (AgCdO) 1/3 Hp (7.2 FLA) (AgNi)	½ Hp (4.9 FLA) (AgCdO) ¾ Hp (6.9 FLA) (AgNi)	B300 – R300	Yes	2 or 3	40 or 85 °C
44.52	E81856	6 A – 277 Vac (R)	1/8 Hp (3.8 FLA)	1/3 Hp (3.6 FLA)	/	Yes	/	85°C
44.62	E81856	10 A – 277 Vac (R)	¼ Hp (5.8 FLA)	¾ Hp (6.9 FLA)	/	Yes	/	85°C
45.31	E81856	16 A – 277 Vac (GU)(AgNi) 16 A – 30 Vdc (GU)(AgNi) 16 A – 30 Vdc (GU)(AgNi) 16 A – 30 Vdc (GU)(AgNi) 16 A – 30 Vdc (GU)(AgNi)	1/3 Hp (7.2 FLA) (AgNi; NO) 1/3 Hp (7.2 FLA) (AgNi; NO) 1/3 Hp (7.2 FLA) (AgNi; NO) 1/3 Hp (7.2 FLA) (AgNi; NO) 1/3 Hp (7.2 FLA) (AgNi; NO)	1 Hp (8 FLA) (AgNi) 1 Hp (8 FLA) (AgNi) 1 Hp (8 FLA) (AgNi) 1 Hp (8 FLA) (AgNi)	/	Yes	2 or 3	105 or 125 °C with a minimum distance among relay of 10 mm
45.71	E81856	16 A – 240 Vac (GU) 16 A – 30 Vdc (GU) (AgCdO) 16 A – 277 Vac (GU) 16 A – 30 Vdc (NO-GU) 12 A – 30 Vdc (NC-GU) (AgNi)	½ Hp (9.8 FLA) (AgCdO) 1/3 Hp (7.2 FLA) (AgNi; NO)	1 Hp (8 FLA) (AgNi)	/	Yes	2 or 3	105 or 125 °C with a minimum distance among relay of 10 mm
45.91	E81856	16 A – 277 Vac (GU)(AgNi) 16 A – 30 Vdc (GU)(AgNi)	1/6 Hp (4.4 FLA) 1/6 Hp (4.4 FLA) 1/6 Hp (4.4 FLA)	½ Hp (4.9 FLA) ½ Hp (4.9 FLA) ½ Hp (4.9 FLA)	/	Yes	2 or 3	105 or 125 °C with a minimum distance among relay of 10 mm
46.52	E81856	8 A – 277 Vac (GU) 6 A – 30 Vdc (R)	¼ Hp (5.8 FLA)	½ Hp (4.9 FLA)	B300 – R300	Yes	2 or 3	70 °C

TABLE 2.1 **Certified products ratings**

R = Resistive / GP = General Purpose / GU = General Use / I = Inductive (cosφ 0.4) / B = Ballast / NO = NO type

Product Type	UL file No.	Ratings			Open Type Devices	Pollution degree	Max Surrounding Air Temperature	
		AC/DC	"Motor Load" Single phase					
			110-120	220-240				
46.61	E81856	16 A – 277 Vac 12 A(NO)-10 A (NC) 30 Vdc (AgNi) 10 A(NO)-8 A(NC) 30 Vdc (AgSnO ₂) 30 Vdc (AgSnO ₂)	1/3 Hp (7.2 FLA)	¾ Hp (6.9 FLA) A300 – R300 (AgSnO ₂)(AgSnO ₂) (AgSnO ₂)(AgSnO ₂)	B300 – R300 (AgNi)	Yes	2 or 3	70 °C
50	E81856	8 A – 277 Vac (GU) 8 A – 30 Vdc (GU)	1/3 Hp (7.2 FLA) (Only NO)	½ Hp (4.9 FLA) (Only NO)	B300 (NO)	Yes	2 or 3	70 °C with a minimum distance among relay of 5 mm
55.X2 – 55.X3	E106390	10 A – 277 Vac (R) 10 A – 24 Vdc (R) (55.X2) 5 A – 24 Vdc (R) (55.X3)	1/3 Hp (7.2 FLA)	¾ Hp (6.9 FLA)	R300	Yes	/	40 °C
55.X4	E106390	7 A – 277 Vac (GP) 7 A – 30 Vdc (GP) (Std/Au contact) 5 A – 277 Vac (R) 5 A – 24 Vdc (R) (AgCdO contact)	1/8 Hp (3.8 FLA)	1/3 Hp (3.6 FLA)	R300	Yes	/	55 °C
56	E81856	12 A – 277 Vac (GU) 12 A – 30 Vdc (GU) (AgNi; NO) 8 A – 30 Vdc (GU) (AgNi; NC) 12 A – 30 Vdc (GU) (AgCdO) 10 A – 30 Vdc (GU) (AgSnO ₂ ; NO)(AgSnO ₂ ; NO) 8 A – 30 Vdc (GU) (AgSnO ₂ ; NC)(AgSnO ₂ ; NC)	½ Hp (9.8 FLA)	1 Hp (8 FLA)	B300	Yes	2 or 3	40 or 70 °C
60	E81856	10 A – 277 Vac (R) 10 A – 30 Vdc (GU)	1/3 Hp (7.2 FLA)	1 Hp (8 FLA)	B300 (AgNi only) R300	Yes	/	40 °C
62	E81856	15 A – 277 Vac (GU) 10 A – 400 Vac (GU) 8 A – 480 Vac (GU) 15 A – 30 Vdc (GU)	¾ Hp (13.8 FLA)	2 Hp (12 FLA) 1 Hp (480 Vac - 3 f); (480 Vac - 3 f) (2.1 FLA) (NO)	B300 (AgCdO) R300	Yes	2 or 3	40 or 70 °C
65.31 65.61	E81856	20 A – 277 Vac (GU)	3/4 Hp (13.6 FLA)	2 Hp (12.0 FLA)	/	Yes	/	70 °C
65.31 NO 65.61 NO		30 A – 277 Vac (GU)						
65.31-S 65.61-S (DC coil, NO only)		35 A – 277 Vac (GU)	/	/				
66	E81856	30 A – 277 Vac (GU) (NO) 10 A – 277 Vac (GU) (NC) 24 A – 30 Vdc (GU) (NO) 30 A – 30 Vdc (GU) (X6XX type only)	1 Hp (16.0 FLA) (AgCdO, NO) ½ Hp (9.8 FLA) (AgNi)	2 Hp (12.0 FLA) (NO)	/	Yes	2 or 3	70 °C with a minimum distance among relay of 20 mm
67	E81856	50 A – 277 Vac (GU) 50 A – 480 Vac (GU) (three phases)	/	/	/	Yes	3	85 °C (60 °C - PCB)
70.61	E106390	6 A – 250 Vac (R) 6 A – 24 Vdc (R)	/	/	/	Yes	2	50 °C
20	E81856	16 A – 277 Vac (R) 1000 W Tung. 120 V 2000 W Tung. 277 V	½ Hp (9.8 FLA)	/	/	Yes	/	40 °C
85.02 – 85.03	E106390	10 A – 277 Vac (R) 10 A – 24 Vdc (R) (85.X2) 5 A – 24 Vdc (R) (85.X3)	1/3 Hp (7.2 FLA)	¾ Hp (6.9 FLA)	/	Yes	/	40 °C
85.04	E106390	7 A – 277 Vac (GP) 7 A – 30 Vdc (GP)	1/8 Hp (3.8 FLA)	1/3 Hp (3.6 FLA)	/	Yes	/	55 °C
7T.81...2301 7T.81...2401	E337851	10 A – 250 Vac (R)		1 ½ Hp (250 Vac) (10 FLA)	/	Yes	2	-20 / +40 °C
7T.81...2303 7T.81...2403	E337851	10 A – 250 Vac (R)		1 ½ Hp (250 Vac) (10 FLA)	/	Yes	2	0 / +60 °C
86	E106390	/	/	/	/	Yes	2	35 or 50 °C
99	E106390	/	/	/	/	Yes	2 or 3	50 °C

TABLE 2.2 **US Certified products ratings**

R = Resistive / GP = General Purpose / GU = General Use / I = Inductive (cosφ 0.4) / B = Ballast / NO = NO type

Product Type	UL file No.	Ratings			Open Type Devices	Pollution degree	Max Surrounding Air Temperature	
		AC/DC	"Motor Load" Single phase					
			110-120	220-240				
22.32 – 22.34	E81856	25 – 277 Vac (GU) 25 A – 30 Vdc (GU) 20 A – 277 Vac (B)	3/4 Hp (13.8 FLA / 82.8 LRA) (AgNi ; NO) 1/2 Hp (9.8 FLA / 5.8 LRA) (AgSnO ₂ ; NO)	2 Hp (12 FLA / 72 LRA) (AgNi ; NO) 1.5 Hp (10 FLA / 60 LRA) (AgSnO ₂ ; NO) Three phase (22.34 NO only) 3 Hp (9.6 FLA / 64 LRA)	A300	Yes	2	50 °C
0.22.33 – 0.22.35	E81856	5 A – 277 Vac (GU)			B300	Yes	2	50 °C
72.01 – 72.11	E81856	15 A – 250 Vac (R)		½ Hp (250 Vac) (4.9 FLA)	/	Yes	2 or 3	50 °C
77.11	E359047	15 A – 277 Vac (GU-B)	¾ Hp	1 Hp	/	Yes	2	45 °C
77.31	E359047	30 A – 400 Vac (GU) 30 A – 277 Vac (B)	¾ Hp	1 Hp ½ Hp (480 Vac)	/	Yes	2	40 °C
80.01-11-21-41-91	E81856	8 A – 250 (R)		½ Hp (250 Vac) (4.9 FLA)	/	Yes	2	40 °C
80.61	E81856	8 A – 250 (GU;R)	/	1/3 Hp (250 Vac) (3.6 FLA)	R300	Yes	2	40 °C
80.82	E81856	6 A – 250 Vac (GU;R)	/	/	B300 – R300	Yes	2	40 °C
83.X1 – 83.X2	E81856	12 A – 250 Vac (GU)	/	/	/	Yes	2	50 °C
83.62	E81856	8 A – 250 Vac (GU)	/	/	/	Yes	2	50 °C
7S	E172124	6 A – 250 Vac (GU same polarity) 6 A – 24 Vdc (GU)		/	B300 (NO)	Yes	/	70 °C

Capacitor start motors

Single phase 230 V AC capacitor start motors have a starting current of about 120% of the rated current. However, damaging currents can result from an instantaneous reversal of the direction of rotation. In the first diagram, high circulating currents can cause severe arcing across the contact gap, as the changeover contacts make an almost instantaneous reversal of polarity to the capacitor. Measurements have shown a peak current of 250 A for a 50 Watt motor, and up to 900 A for a 500 Watt motor. This inevitably leads to welding of the contacts.

Reversing the direction of such motors should therefore use two relays, as the second diagram shows, whereby in the control to the relay coils a "dead break" of approximately 300 ms is provided. The delay can either be provided by another control component such as a Timer, or through the Microprocessor etc., or by connecting a suitable NTC resistance in series with each relay coil. Cross interlocking the coil circuits of both relays will not produce the required delay! Moreover, the use of anti-weld contact material will not solve the problem.

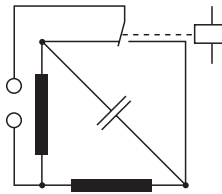

Incorrect AC motor reversal:

Contact is in the intermediate state for less than 10 ms – insufficient time to allow the energy in the capacitor to dissipate before the electrical connection is remade to the opposite polarity.

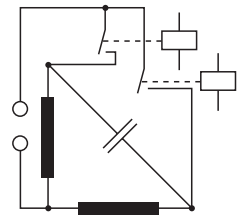

Correct AC motor reversal:

Provision of 300 ms "dead break" time when neither relay contacts are closed - during which time the capacitor discharges harmlessly through the motor windings.

TABLE 2.3 **Certified sockets ratings**

Socket type	UL ratings	CSA ratings	Open Type Devices	Pollution degree (Installation environment)	Max Surrounding Air Temperature	System Overvoltage Category (max peak Voltage impulse)	Conductors to be used	Wire size (AWG)	Terminal tightening torque
90.02/03	10 A 300 V	10 A 300 V (max 20 A Total Load)			70 °C				
90.14/15	10 A 300 V	10 A 250 V							
90.20/21/26/27	10 A 300 V	10 A 250 V							
90.82.3	10 A 300 V	10 A 300 V			70 °C			14-20 stranded and solid	7.08 lb.in. (0.8 Nm)
90.83.3	10 A 300 V	10 A 300 V			65 °C			14-20 stranded and solid	7.08 lb.in. (0.8 Nm)
92.03	16 A 300 V	10 A 250 V (max 20 A Total Load)			70 °C		75 °C Cu only	10-24, stranded or solid	7.08 lb.in. (0.8 Nm)
92.13/33	16 A 300 V	10 A 250 V							
93.01/51	6 A 300 V	6 A 250 V			60 °C		75 °C Cu only	14-24, stranded or solid	
93.02/52	2 x 10 A 300 V (60 °C) 2 x 8 A 300 V (70 °C)	2 x 10 A 300 V (60 °C) 2 x 8 A 300 V (70 °C)	Yes	2	60 or 70 °C	II (2.5 kV)	75 °C Cu only (CSA)		
93.11	6 A 300 V	6 A 300 V			70 °C				
93.21	6 A 300 V	/	Yes	2	70 °C				
93.60/65/66/67/68	6 A 300 V (40 °C) 4 A 300 V (70 °C)	6 A 300 V (40 °C) 4 A 300 V (70 °C)			40 or 70 °C		75 °C Cu only	14-24, stranded or solid	
93.61/62/63/64/68	6 A 300 V (40 °C) 4 A 300 V (70 °C)	6 A 300 V (40 °C) 4 A 300 V (70 °C)			40 or 70 °C		75 °C Cu only	14-24, stranded or solid	4.43 lb.in. (0.5 Nm)
09368141	100 mA 24V	100 mA 24V			70 °C				
94.02/03/04	10 A 300 V	10 A 250 V (max 20 A Total Load)			70 °C		75 °C Cu only	10-24 stranded, 12-24 solid	4.43 lb.in. (0.5 Nm)
94.12/13/14	10 A 300 V (4 pole: 5A 300 V)	10 A 250 V							
94.22/23/24	10 A 300 V	10 A 250 V							
94.33/34	10 A 300 V (4 pole: 5A 300 V)	10 A 250 V							
94.54	10 A 300 V		Yes		70 °C		Copper only	14-18-24 stranded and solid	
94.62/64	10 A 300 V	10 A 250 V							
94.72/73/74	10 A 300 V	10 A 250 V (94.74: max 20 A Total Load)							
94.82	10 A 300 V	10 A 250 V							
94.82.3/92.3	10 A 300 V		Yes		70 °C				
94.84.3/94.3	10 A 300 V		Yes		55 °C				
94.82.2	10 A 300 V		Yes		50 °C				
94.84.2	7 A 300 V		Yes		50 °C				
95.03/05	10 A 300 V	10 A 250 V (max 20 A Total Load)			70 °C		75 °C Cu only	10-24 stranded, 12-24 solid	4.43 lb.in. (0.5 Nm)
95.13.2/15.2	12 A 300 V	10 A 300 V (max 20 A Total Load)	Yes		70 °C with a minimum distance of 5 mm				
95.55/55.3	10 A 300 V (40 °C) 8 A 300 V (70 °C)	10 A 300 V (40 °C) 8 A 300 V (70 °C)	Yes		40 or 70 °C			14-24 stranded and solid	
95.23	10 A 300 V	10 A 250 V							
95.63/65/75	10 A 300 V	10 A 250 V							
95.83.3/85.3/ 93.3/95.3	12 A 300 V		Yes		85 °C			14-18, stranded or solid	7.08 lb. in. (0.8 Nm)
96.02/04	12 A 300 V (50 °C) 10 A 300 V (70 °C)	12 A 300 V (50 °C) 10 A 300 V (70 °C)	Yes		50 or 70 °C	III (4.0 kV)	60/75 °C Cu only 75 °C Cu only (CSA)	10-14, stranded or solid	7.08 lb.in. (0.8 Nm)
96.12/14	12 A 300 V	15A 250 V							
96.72/74	15 A 300 V	10 A 250 V (max 20 A Total Load)							
97.01	16 A 300 V (50 °C) 12 A 300 V (70 °C)	16 A 300 V (50 °C) 12 A 300 V (70 °C)	Yes		50 or 70 °C		75 °C Cu only (CSA)		
97.02	2x8 A 300 V	2x8 A 300 V	Yes		70 °C		75 °C Cu only (CSA)		
97.11	16 A 300 V (50 °C) 12 A 300 V (70 °C)	/	Yes		50 or 70 °C with a minimum distance of 5 mm				
97.12	2 x 8 A 300 V	/	Yes		70 °C with a minimum distance of 5 mm				
97.51 - 97.51.3	15 A 300 V (40 °C) (2-wires/per pole) 10 A 300 V (70 °C)	15A 300 V (40 °C) 10 A 300 V (70 °C)	Yes		40 or 70 °C			14-24 stranded and solid	
97.52 - 97.52.3	10 A 300 V (40 °C) 8 A 300 V (70 °C)	8 A 300 V	Yes		70 °C			14-24 stranded and solid	

Three-phase alternating current loads

Larger three-phase alternating current loads should preferably be switched with contactors according to EN 60947-4-1 Electromechanical contactors and motor starters. Contactors are similar to relays but they have their own characteristics; typically compared to relays:

- They can normally switch different phases at the same time.
- They are physically much larger.
- Their design and construction usually features double break contacts.
- They can withstand certain short-circuit conditions.

There is nevertheless, some overlap between relays and contactors regarding switching characteristics and applications.

However, when switching three-phase alternating current with relays, consider and take into account:

- The isolation co-ordination, i.e. the voltage stress and the degree of pollution between the contacts according to the insulation rated voltage.
- And, avoid the use of the NO relay versions with 3 mm contact gaps, unless the isolation afforded by the contact gap is specifically required.

Three-phase motors

Higher power three-phase motors are often switched by a 3-pole contactor, where there is high isolation/separation between phases. However, for space, size and other reasons, relays are also called upon to switch 3-phase motors.

TABLE 3 Motor ratings v relay series

Relay series	Motor Power (400 V 3 phase)		Permissible degree of pollution	Impulse voltage
	kW	PS(hp)		
55.33, 55.13	0.37	0.50	2	4
56.34, 56.44	0.80	1.10	2	4
60.13, 60.63	0.80	1.10	2	3.6
62.23, 62.33, 62.83	1.50	2.00	3	4

62 series relay is also capable to switch 1 hp 480 V 3 phase motors

Reversing the motor: Take particular care if it is required to change the motor direction by reversing two of the supply phases applied to the motor terminals, as this will result in severe damage unless there is a "dead time" between the changeover. Therefore, use one relay for the forward direction and another for the reverse direction (as the following diagram). And, most importantly, ensure that there is a "dead time" of no less than 50 ms - when neither relay coil is energised. Simple cross interlocking of the relay coils will not produce a Time delay! However, choosing a tougher, anti-weld contact material may further improve the reliability and performance, and is advised.

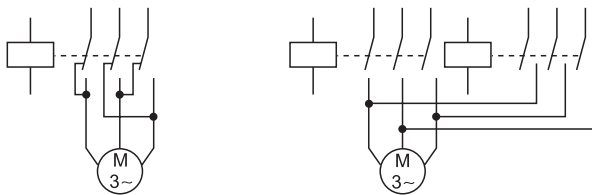

Incorrect three-phase motor reversal: The electrical stress of opposing phase voltages across the contact gap, together with contact arcing can result in a phase to phase short-circuit.

Correct three-phase motor reversal: "Dead break" time of > 50 ms, during which time neither the Forward nor the Reverse relay contacts are closed.

Notes:

- 1 - For AC3 category (starting and switching off) - motor reversal is only permitted if there is a guaranteed break of 50 ms between energisation in one direction and energisation in the other. Observe the maximum starts per hour, according to the motor manufacturer's recommendation.
- 2 - AC4 category (starting, plugging, reversing and inching/jogging) is not possible with relays or small contactors. In particular, the direct reversing of phase connections for "plugging" will result in severe contact arcing leading to a short-circuit within the relay or contactor.
- 3 - Under certain circumstances it may be preferable to use three single pole relays to control each phase individually, and so achieve greater separation between the phases. (Any relatively small time difference between the operation times of the three relays is insignificant compared to the much slower operation of contactors.)

Switching different voltages within a relay

Switching different voltages in a relay e.g. 230 V AC with one contact and 24VDC with a neighboring contact is possible - provided that the Insulation type between adjacent contacts is at least of Basic level. However, note that the equipment standard might demand a higher level that is not possible using adjacent contacts on the same relay. The possibility of using more than one relay could be considered.

Contact resistance

Measured, according to Application Category (Table 4), at the external terminals of the relay. It is a final test value, not necessarily reproducible subsequently. It has little effect on relay reliability for most applications since a typical value would be < 50 mΩ (measured with 24 V 100 mA).

Contact categories according to EN 61810-7

The effectiveness with which a relay contact can make an electrical circuit depends on several factors, such as the material used for the contact, its exposure to environmental pollution and its design etc. Therefore, for reliable operation, it is necessary to specify a Contact Category, which is defined in terms of the characteristics of the load. The appropriate Contact Category will also define the voltage and current levels used to measure the contact resistance. All Finder relays are category CC2.

TABLE 4 Contact categories

Contact category	Load characteristic	Contact Resistance Measurement	
		30 mV	10 mA
CC0	Dry circuit	30 mV	10 mA
CC1	Low load without arcing	10 V	100 mA
CC2	High load with arcing	30 V	1 A

TABLE 5 Contact materials characteristics

Material	Property	Typical application
AgNi + Au (Silver Nickel Gold plated)	- Silver-nickel base with a galvanic hard gold plating - Gold is not attacked by industrial atmospheres - With small loads, contact resistance is lower and more consistent compared to other materials. NOTE: hard gold plating is completely different to 0.2 μm gold flashing, which allows only protection in storing, but no better performance in use.	Wide range applications: - Small load range (where gold plating erodes very little) from 50 mW (5 V - 2 mA) up to 1.5 W/24 V (resistive load). - Middle load range where gold plating erodes after several operations and the property of basic AgNi becomes dominant. NOTE: for switching lower load, typically 1 mW (0.1 V - 1 mA), (for example in measuring instruments), it is recommended to connect 2 contacts in parallel.
AgNi (Silver Nickel)	- Standard contact material for most relay applications - High wear resistance - Medium resistance to welding	- Resistive and slightly inductive loads - Rated current up to 12 A - Inrush current up to 25 A
AgCdO (Silver Cadmium Oxide)	- High wear resistance with higher AC loads - Good resistance to welding	- Inductive and motor loads - Rated current up to 30 A - Inrush current up to 50 A
AgSnO ₂ (Silver Tin Oxide)	- Excellent resistance to welding	- Lamp and capacitive loads - Very high Inrush current (up to 120 A) loads

Coil specification

Nominal voltage

The nominal value of coil voltage for which the relay has been designed, and for which operation is intended. The operating and performance characteristics are with respect to the coil at nominal voltage.

Rated power

The DC power value (W) or the apparent AC power value (VA with closed armature) which is absorbed by the coil at 23 °C and at rated voltage.

Operating range

The range of input voltage, in nominal voltage applications, in which the relay works in the whole range of ambient temperatures, according to operating class:

- class 1: (0.8...1.1)U_N
- class 2: (0.85...1.1)U_N

In application where the coil voltage doesn't meet the tolerances of nominal voltage, the diagrams "R" shows the relation of maximum coil voltage permitted and pick-up voltage (without pre-energisation) versus ambient temperature.

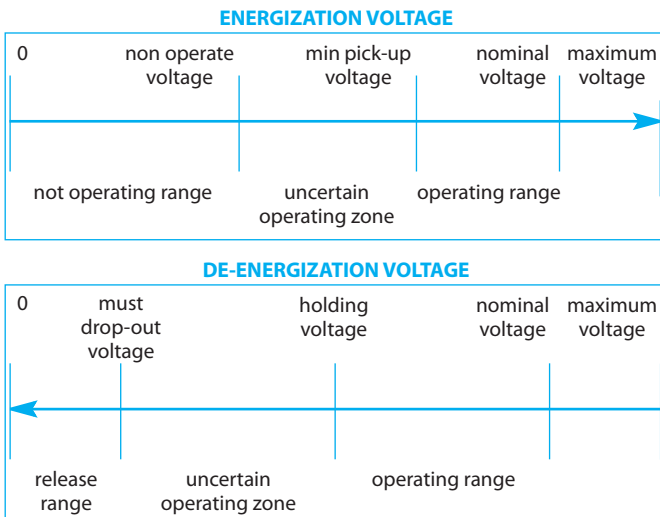

Non-operate voltage

The highest value of input voltage at which the relay will not operate (not specified in the catalogue).

Minimum Pick-up voltage (Operate voltage)

The lowest value of applied voltage at which the relay will operate.

Maximum permitted voltage

The highest applied coil voltage that the relay can continuously withstand, dependent on ambient temperature (see "R" diagrams).

Holding voltage (Non-release voltage)

The lowest value of coil voltage at which the relay (which has previously been energised with a voltage within the operating range) will not drop-out.

Must drop-out voltage (Must release voltage)

The highest value of coil voltage at which the relay (having previously been energised with a voltage within the operating range) will definitely drop-out. The same "per unit" value can be applied to the nominal coil current value to give an indication of the maximum leakage current that may be permitted in the coil circuit, before problems with relay release might be expected.

Coil Resistance

The nominal value of the coil resistance under the standard prescribed condition of 23 °C ambient. Tolerance is ± 10%.

Rated coil consumption

The nominal value of coil current, when energized at nominal voltage (and at 50 Hz for AC coils).

Thermal tests

Calculation of the coil temperature rise (ΔT) is made by measuring the coil resistance in a temperature controlled oven (not ventilated) until a stable value is reached (no less than 0.5 K variation in 10 minutes).

$$\text{That is: } \Delta T = (R_2 - R_1) / R_1 \times (234.5 + t_1) - (t_2 - t_1)$$

where:

- R1 = initial resistance
- R2 = final resistance
- t1 = initial temperature
- t2 = final temperature

Monostable relay

An electrical relay which, having responded to coil energisation by changing contact state, returns to the previous contact state when the coil energisation is removed.

Bistable relay

An electrical relay, which, having responded to coil energisation by changing contact state, retains that contact state after the coil energisation has been removed. A further energisation of the coil is necessary to cause the contact state to revert.

Latching relay

A bistable relay, where the contacts retain their state due to a mechanical latching mechanism. Subsequent applications of coil energisation causes the contacts to "toggle" open and closed.

Remanence relay

A bistable relay, where the contacts retain their operated (or Set) state due to remanent magnetism in the relay iron circuit caused by the application of a DC current through the coil. Resetting the contact state is achieved by passing a smaller DC current through the coil in the opposite direction. For AC excitation, magnetization takes place via a diode to produce a DC set current, and demagnetising is achieved by applying an AC coil current of lower magnitude.

Insulation

EN/IEC 61810-1 Relay standard

The "Scope" of the relay standard says of itself "... IEC 61810-1 applies to electromechanical elementary relays (non-specified time all-or-nothing relays) for incorporation into equipment. It defines the basic functional requirements and safety-aspects for applications in all areas of electrical engineering or electronics, such as:

- general industrial equipment,
- electrical facilities,
- electrical machines,
- electrical appliances for household and similar use,
- information technology and business equipment,
- building automation equipment,
- automation equipment,
- electrical installation equipment,
- medical equipment,
- control equipment,
- telecommunications,
- vehicles,
- transportation (e.g. railways).

Relay function and Isolation

One of the main functions of a relay is to connect and disconnect different electric circuits, and usually, to maintain a high level of electrical separation between the various circuits. It is therefore necessary to consider the level of isolation appropriate to the application and the task to be performed - and to relate this to the relay's specification. In the case of electromechanical relays the areas of isolation generally considered are:

- Isolation between coil and all contacts (the "contact set").
Catalogue data - "Insulation between coil and contact set".
- Isolation between physically adjacent, but electrically separate, contacts of a multi-pole relay. Catalogue data - "Insulation between adjacent contacts".
- Isolation between the open contacts (applies to the NO contact, and the NC contact when the coil is energised).
Catalogue data - "Insulation between open contacts".

Specifying isolation levels

There are several ways of specifying or describing the level of isolation offered by, or demanded of, a relay. These include:

Insulation coordination, which focuses on the levels of impulse voltage likely to be seen on the supply lines of the application equipment and the cleanliness of the immediate surroundings of the relay in the equipment. And, as a consequence, it demands appropriate levels of separation between circuits, in terms of isolating distances and quality of insulating material used etc. (see additional information under “Insulation coordination”).

Type of insulation: For both equipment and components such as a relay, there are several types (or levels) of insulation that might be demanded between the various circuits. The appropriate type will depend on the specific function being performed, the voltage levels involved, and the associated safety consequences. The various types of insulation are listed below, and those appropriate to each relay series are stated within the relay data; Specifically, within the table under the section entitled **Technical data**, sub-heading; Insulation.

Functional insulation: Insulation between conductive parts, which is necessary only for the proper functioning of the relay.

Basic insulation: Insulation applied to live parts to provide basic protection against electric shock.

Supplementary insulation: Independent insulation applied in addition to basic insulation, in order to provide protection against electric shock in the event of a failure of basic insulation.

Double insulation: Insulation comprising both basic insulation and supplementary insulation.

Reinforced insulation: A single insulation system applied to live parts, which provides a degree of protection against electric shock equivalent to double insulation.

(Usually, the decision as to the appropriate type of insulation will have already been made by the equipment standard.)

Dielectric strength, and high voltage impulse tests: These are either, final inspection or Type tests, which prove the level of isolation in terms of the minimum voltage stress that can be withstood, between the various specified electrical circuits. As the only method of specifying and checking for adequate isolation, this tends to be the more historical approach. However, there are still some dielectric strength requirements to be found within both the Insulation coordination approach and the Level of Insulation approach.

Insulation coordination

In accordance with EN 61810-1 and IEC 60664-1:2003, the Insulation characteristics offered by a relay can be described by just two characteristic parameters – the **Rated Impulse Voltage** and the **Pollution Degree**.

To ensure the correct Insulation Coordination between the relay and the application, the equipment designer (relay user) should establish the **Rated Impulse Voltage** appropriate to his application, and the **Pollution Degree** for the microenvironment in which the relay is situated. He should then match (or coordinate) these two figures with the corresponding values given in the appropriate relay data, under the section entitled **Technical data**, sub-heading; Insulation.

Rated Impulse Voltage: To establish the appropriate Rated Impulse Voltage refer to the appropriate Equipment Standard which may specify mandatory values for equipment being designed. Alternatively, using the Rated Impulse Voltage table (Table 6) with knowledge of the Nominal Voltage of the Supply System and knowledge of the Overvoltage Category, determine the appropriate Rated Impulse Voltage.

Overvoltage Category: this is described in IEC 60664-1, but is also summarised in the footnotes to Rated Impulse Voltage table. Alternatively, it may be specified in the equipment standard.

Pollution Degree: determine this by considering the immediate surroundings of the relay (refer to Pollution Degree table 7). Then check that the relay specification offers the appropriate (or better) Rated Impulse Voltage and Rated Insulation Voltage, for that Pollution Degree.

Nominal voltage of supply system

This effectively describes the source of the power supply system, so 230/400 V AC indicates that this would be (or is likely to be) a three-phase sub-station transformer with a Neutral connection. Being aware of the source of the supply system is important since (in conjunction with the Overvoltage category) it determines the typical levels of impulse voltage likely to be seen on the supply lines, and this has to be taken into account in the designing of the relay. However, it does not necessarily follow that the relay will be rated by the manufacturer for use at the highest voltage of the supply system. It is the declared Rated Insulation Voltage that confirms this aspect.

Rated Insulation Voltage

This is a notional value of voltage that indicates the relay's insulation as being suitable for handling voltages up to this level. Note that this notional Rated Insulation Voltage is selected from a list of preferred values. For Finder relays, 250 V and 400 V are two such preferred values, and of course they will cover respectively, the 230 V L-N and 400 V L-L voltages commonly encountered in practice.

TABLE 6 Rated impulse voltage

Nominal voltage of the supply system ⁽¹⁾ V		Rated insulation voltage V	Rated impulse voltage kV			
Three-phase systems	Single-phase systems		Overvoltage category			
			I	II	III	IV
	120 to 240	125 to 250	0.8	1.5	2.5	4
230/400		250/400	1.5	2.5	4	6
277/480		320/500	1.5	2.5	4	6

(1) In accordance with IEC 60038.

Remark: The descriptions of overvoltage categories below are for information. The actual overvoltage category to be considered has to be taken from the product standard defining the application of the relay.

Overvoltage category I Applies to equipment intended for connection to fixed installations of buildings, but where measures have been taken (either in the fixed installation or in the equipment) to limit transient overvoltages to the level indicated.

Overvoltage category II Applies to equipment intended for connection to fixed installations of buildings.

Overvoltage category III Applies to equipment in fixed installations, and for cases where a higher degree of availability of the equipment is expected.

Overvoltage category IV Applies to equipment intended for use at or near the origin of the installation, from the main distributor towards the supply mains.

TABLE 7 Pollution degree

Pollution degree	Immediate surroundings of relay
1	No pollution or only dry, non-conductive pollution occurs. The pollution has no influence.
2	Only non-conductive pollution occurs, except that occasionally a temporary conductivity caused by condensation is to be expected.
3	Conductive pollution occurs or dry, non-conductive pollution occurs which becomes conductive due to condensation, which is to be expected.

Dependent on the product standard, pollution degree 2 and 3 are commonly prescribed for equipment. For example, EN 50178 (electronics for use in power installations) prescribes, under normal circumstances, contamination level 2.

Dielectric strength

This can be described in terms of an AC voltage test, or in terms of an Impulse (1.2/50 μs) voltage test. (The correspondence between the AC test and Impulse voltage test is listed in IEC 60664-1 Annex A, Table A.1). All Finder relays receive a 100% final inspection AC (50 Hz) dielectric strength test; applied between all contacts and coil, between adjacent contacts, and across open contacts. The leakage current must be less than 3 mA. For Type testing, both AC and Impulse voltage dielectric strength tests are applied.

Insulation Group

This was the older Insulation Group classification (such as C 250), which was according to the VDE 0110 standard. They have largely been replaced with the more recent way of specifying insulation properties, according to Insulation Coordination.

SELV, PELV and Safe separation

Insulation Coordination as described earlier ensures the isolation of hazardous voltages from other circuits to a safe engineering level, but may not be adequate on its own if the design of the equipment permits the LV circuit to be accessible and therefore able to be touched directly or, where the nature and location of the electrics presents extra dangers.

Therefore, for these extra dangerous applications (such as swimming pool lighting or bathroom electrics) there can be a need for a special low voltage supply system (SELV or PELV), that is inherently safe and highly secure, working at low voltage and with much higher levels of physical isolation and integrity between it and other hazardous circuits.

The SELV system

The SELV system (Separated Extra Low Voltage) is achieved by designing with double or reinforced insulation and by ensuring “safe separation” from hazardous circuits in accordance with regulations for SELV circuits. The SELV voltage (which is isolated from Ground) must be derived via a safety transformer meeting double or reinforced isolation between the windings, as well as other safety requirements demanded by the appropriate standard.

Note: The value for the “safe voltage” can differ slightly dependent upon the particular application or end product regulation.

There are specific requirements for keeping SELV circuits and wiring separate from other hazardous circuits, and it is this aspect concerning the separation of the coil to contacts that is met by several Finder relays as standard, and as a special version of the 62 series of relays - where an additional barrier is a special option.

The PELV system

The PELV system (Protected Extra Low Voltage), like the SELV system, requires a design that guarantees a low risk of accidental contact with a high voltage, but in contrast, it has a protective earth (ground) connection. Like SELV, the transformer can have windings separated by double or reinforced insulation, or by a conductive shield with a protected earth connection.

Consider a common situation, where the mains voltage of 230 V and a low voltage circuit both appear within a relay; all the following requirements must be met by the relay - and also applied to the connections/wiring to it.

- The low voltage and the 230 V must be separated by double or reinforced insulation. This means that between the two electrical circuits there must be guaranteed a dielectric strength of 6 kV (1.2/50 μs), an air distance of 5.5 mm and, depending on the pollution degree and on material used, an appropriate tracking distance.
- The electrical circuits within the relay must be protected against any possibility of bridging, caused for instance by a loose metal part. This is achieved by the physical separation of circuits into isolated chambers within the relay.
- The different voltage wiring connected to the relay must also be physically separated from each other. This is normally achieved by using separate cable channels.
- For relays mounted on printed circuit boards the appropriate distance between the tracks connected to low voltage and the tracks connected to other voltages must be achieved. Alternatively, earth barriers can be interposed between hazardous and safe parts of the circuitry.

Although this appears quite complex, with the SELV capability/options offered by some Finder relays, the user only needs to address the two last points. And, when using a socket where the coil and contact connections are on opposite sides, the separation of wiring into different cable channels is greatly facilitated.

General technical data

Cycle

The operate and subsequent release of a relay. Over a cycle, the coil is energised and de-energised, and a (NO) contact will have progressed through a cycle of making circuit, through to breaking the circuit, back to the point at which it is just about to re-make the circuit.

Period

The time taken by one cycle.

Duty factor (DF)

During cyclic operation, the Duty Factor is the ratio between the time the relay is energized, to the time taken for one cycle (i.e. the Period). For continuous duty, the DF = 1.

Continuous operation

This would represent the condition where the coil is permanently energized, or is energized for at least sufficient time for the relay to reach thermal equilibrium.

Mechanical life

This is derived from a test performed by energising the coils of several relays at 5 to 10 cycles per second without any load applied to the contacts. It establishes the ultimate durability of the relay where electrical wear of the contacts is not an issue. The maximum Electrical Life may therefore approach the Mechanical Life where the electrical loading of the contacts is very small.

Operate time

The typical time (average of values measured supplying the relay coil with the nominal DC voltage) for the NO contact to close, from the point of coil energisation. It does not include the bounce time (see following pattern).

Release time

- For CO relays: The typical time (average of values measured removing from the coil the DC voltage) for the NC contact to close, from the point of coil de-energisation. It does not include the bounce time.

- For NO relays: The typical time (average of values measured removing from the coil the DC voltage) for the NO contact to open, from the point of coil de-energisation. It does not include the bounce time.

Note: The release time will increase if a suppression diode in parallel with the coil is employed (either in the form of; a coil protection module; integrated option within the relay; or mounted directly on the PCB).

Bounce time

The typical time duration (average of values measured) while closing contacts bounce, before attaining a stable closed state. Different values generally apply to NO and NC contacts.

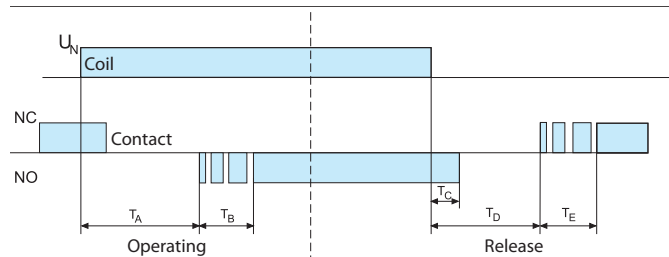

- T_A Operate time
- T_B Bounce time for NO contact
- T_C Release Time (NO relays)
- T_D Release Time (CO relays)
- T_E Bounce time for NC contact

Ambient temperature

The temperature of the immediate area where the relay is located. It will not necessarily correspond to the ambient temperature either within, or external to, the enclosure in which the relay is located. To accurately measure the ambient temperature with respect to the relay, remove the relay from its location whilst maintaining the worst-case energisation of all the other relays and components within the enclosure or panel. Measuring the temperature at the position vacated by the relay will give the true ambient temperature in which the relay is working.

Ambient temperature range

The temperature range over which, operation of the relay is guaranteed (under prescribed conditions).

Storage temperature range

This can be taken as the ambient temperature range, with the upper and lower limits extended by 10 °C.

Environmental protection

According to EN 61810-1. The RT categories describe the degree of sealing of the relay case:

Environmental protection category		Protection
RT 0	Unenclosed relay	Relay not provided with a protective case.
RT I	Dust protected relay	Relay provided with a case, which protects its mechanism from dust.
RT II	Flux proof relay	Relay capable of being automatically soldered without allowing the migration of solder fluxes beyond the intended.
RT III	Wash tight relay	Relay capable of being automatically soldered and subsequently undergoing a washing process to remove flux residues without allowing the ingress of flux or washing solvents.
Special application categories		
RT IV	Sealed relay	Relay provided with a case which has no venting to the outside atmosphere.
RT V	Hermetically sealed relay	Sealed relay having an enhanced level of sealing.

Protection category

According to EN 60529. The first digit is related to the protection against the intrusion of solid foreign objects into the relay, and also against access to hazardous parts. The second digit relates to the protection against ingress of water. The IP category relates to the relay, when used normally in relay sockets or PC boards.

For sockets, IP 20 signifies that the socket is "finger-safe" (VDE 0106).

IP Examples:

IP 00 = Not protected.

IP 20 = Protected against solid foreign objects of 12.5 mm Ø and greater. Not protected against water.

IP 40 = Protected against solid foreign objects of 1 mm Ø and greater. Not protected against water.

IP 50 = Protected against powder (ingress of dust is not totally prevented, but dust shall not penetrate in a quantity to interfere with satisfactory operation of the relay). Not protected against water.

IP 51 = As IP 50, but with protection against vertically falling drops of water.

IP 54 = As IP 50, but with protection against sprayed from all directions - limited ingress permitted.

IP 67 = Totally protected against powder (dust-tight) and protected against the effects of temporary immersion in water.

Vibration resistance

The maximum level of sinusoidal vibration, over the specified frequency range, which can be applied to the relay in the X-axis without the opening (for more than 10 µs) of the NO contact (if the coil is energised) or NC contact (if the coil is not energised). (The X-axis is the axis through the plane of the relay face containing the relay terminals). The vibration resistance is usually higher in the energised state, then in the non-energised state. Data for other axes and frequency ranges, on request. The level of vibration is given in terms of the maximum acceleration of the sinusoidal vibration, "g" (where g = 9.81 m/s²). But note: the normal testing procedure according to IEC 60068-2-6 prescribes to limit the maximum peak-to-peak displacement in the lower range of frequencies.

Shock resistance

The maximum mechanical shock (half-sine 11 ms waveform) permitted in the X-axis without contact opening > 10 µs. Data for other axes on request.

Installed orientation

The component's specification is unaffected (unless expressly stated otherwise) by its orientation, (provided it is properly retained, eg by a retaining clip in the case of socket mounted relays.)

Power lost to the environment

The value of the power lost from the relay with the coil energised (without contact current, or with full rated current through all NO contacts). This may be used in the thermal design and regulation of the control panel.

Recommended distance between relays mounted on printed circuit boards

This is the minimum mounting distance suggested when several relays are mounted on the same PC board. Care and consideration shall be given to ensure that other components mounted on the PC board do not heat the relay and raise its microenvironment beyond the permitted maximum ambient temperature.

Torque

The maximum value of torque that can be used for tightening terminal screws, according to EN 60999, is 0.4 Nm for M2.5 screws, 0.5 Nm for M3 screws, 0.8 Nm for M3.5 screws, 1.2 Nm for M4 screws. The test torque is indicated in the catalogue. Normally a 20% increase of this value is acceptable.

Both slot-head and cross-head screwdrivers can be used.

Minimum Wire size

For all types of terminal, a minimum cross-section of 0.5 mm² is permitted.

Max. wire size

Maximum cross-section of cables (solid or stranded wire, without ferrules) that can be connected to each terminal. For use with ferrules, the wire cross-section has to be reduced (e.g. from 4 to 2.5 mm², from 2.5 to 1.5 mm², from 1.5 to 1 mm²).

Terminating more than one wire

EN 60204-1 permits 2 or more wires to be terminated in the same terminal. All Finder products are designed in such a way that each terminal can accept 2 or more wires, except screwless terminals.



Box clamp

Wires are terminated within a box shaped clamp. Effective retention of solid, stranded and "bootlace" wires, but not suitable for wires terminated with "fork" style terminations.



Plate clamp

Wires are terminated under the pressure of a clamp plate. Effective for "fork" terminated wires and solid wire, but less so for stranded wire.



Screwless terminal (Spring clamp)

Wires are terminated under the pressure of a spring clamp. The clamp being temporarily held open by the insertion of a tool, while the wire is inserted.



Push-in terminal

Similarly to spring clamp terminals, wires are terminated under the pressure of a spring clamp. Solid wires or ferrules can be quickly connected by their simple insertion into the terminal. For stranded wires insertion, and for each wire type extraction, it is necessary first to open the terminal by pushing down on the push-button.

SSR - Solid State Relay

SSR Solid State Relay

A relay utilising semiconductor technology, rather than electromechanical. In particular, the load is switched by a semiconductor and consequently these relays are not subject to burning of contacts and there is no migration of contact material.

SSRs are capable of very high speed switching and virtual unlimited life. However, SSRs for switching DC are polarity sensitive and consideration must given to the maximum permitted blocking voltage.

Opto-coupler

For all SSR relays in the catalogue, the electrical isolation between Input and Output circuits is provided by the use of an opto-coupler.

Switching voltage range

The minimum to maximum (nominal) range for the load voltage. (The maximum value can be extended to cover the normal upper tolerance expected for the load voltage supply.)

Minimum switching current

The minimum value of load current necessary to ensure correct switch-on and switch-off action.

Control current

The nominal value of input current, at 23 °C and with rated voltage applied.

Maximum blocking voltage

The maximum level of output (load) voltage that the SSR can withstand.

Relay with forcibly guided (mechanically linked) contacts, or safety relay

A relay with forcibly guided contacts is a special type of relay which must satisfy the requirements of a very specific safety EN standard.

Such relays are used within safety systems to guarantee their operational safety and reliability, contributing to a safe working environment.

Such relays must have at least one NO and one NC forcibly guided contact. These contacts must be mechanically linked, such that if one of the contacts fails to open, the other is prevented from closing (and vice versa). This requirement is fundamental in order to identify with certainty the non-correct operation of a circuit. For example, a failure of a NO contact to open (for example, by welding closed) is identified by the failure of the NC from closing, thereby signaling an operational anomaly. Under such circumstances, the standard requires a guaranteed contact gap of 0.5 mm to be maintained.

EN 61810-3 is the standard that establishes the requirements for relays with forcibly guided contacts, and it describes two types:

- Type A: where all the contacts are forcibly guided
- Type B: where only some contacts are forcibly guided

According to EN 61810-3, in a relay with changeover contacts, only the NO of one pole and the NC of the other pole can be considered as forcibly guided contacts. In the case of the 50 series relay this means the remaining poles cannot be considered as forcibly guided and therefore this relay is categorised as "Type B".

However, since the 75 relay series offer only NO and NC contacts they can be categorized as "Type A".

Monitoring and Measuring relays

Supply voltage monitoring

The supply voltage being monitored also provides the operating power for the unit, so an auxiliary supply is not necessary. (Not applicable to the Universal voltage monitoring relay 71.41)

3-phase asymmetry monitoring

In a 3-phase system, asymmetry is present if at least one of the three L - L voltage vectors fails to be at 120° with respect to the other L - L voltage vectors.

Detection level

For monitoring relays, this represents, either fixed or adjustable level(s) of voltage, current or phase asymmetry, which define the acceptable limits of operation. Values outside acceptable limits will cause the output relay NO contact to open (after any intentional delay).

Switch-on lock-out time

For over and under voltage monitoring relays this is a selectable time delay to ensure that the output relay cannot re-energise too quickly (following a trip and the re-establishment of healthy conditions). Protects equipment where a quick succession of restarts might cause overheating and damage. Same delay applies immediately following "power-on".

Start delay (T2)

Current monitoring relay 71.51; immediately on the detection of current flow (following a period of no current flow) "out of limits" current detection is inhibited for time period T2. Useful for ignoring inrush currents that commonly occur at switch-on of sodium lamps or motors etc.

Switch-off time

This refers to the time taken for the output relay to de-energise, following the detection of conditions requiring this.

Depending on the particular monitoring relay, a short time may be demanded (i.e. < 0.5 secs - 72.61), or in the case of the 71.41 a longer delay may be preferred (ie, variable 0.1 to 12 secs). In the case of the latter, this delay is useful for ignoring momentary or short-term excursions of the measured/monitored value outside of limits.

Trip on-delay

Similar in effect to the switch-off delay, this delays the "trip" signal that would result in the output relay switching off. The term is used primarily for monitoring relays which monitor and act according to several parameters. But the effect is the same, and momentary or short-term excursions of the measured/monitored values outside of limits are ignored.

Run-on time

With liquid level control relays the pump motor can be turned on (or off) within 0.5 to 1 second of the liquid reaching or departing the level of the electrode. Depending on model, this delay can be increased up to 7 seconds, which will have the effect of the liquid level running past the electrode level. This can help prevent "hunting" of the motor, which might otherwise have happened due to ripples, or foam, on the surface of the liquid.

Reaction time

For monitoring relays, this is the maximum time taken by the electronics to respond to changes in the monitored value.

Fault memory

For monitoring relays; selecting this function will inhibit the automatic reset following clearing of fault condition. Reset can only be made by positive intervention.

Fault memory - status retained on power down

As above but the fault memory status will be retained during power down.

Switch-ON hysteresis

For monitoring relays type 71.41 and 71.51, the switch-on level can be offset from the set level by a (hysteresis) percentage. The desired percentage can be selected during relay set-up.

Thermistor temperature sensing

Over-temperature monitoring via a PTC resistance sensor, with in-built checking for sensor open or short circuit faults.

Level control relay

Detects the level of conductive liquids by measuring and evaluating the resistance between either 2 or 3 level electrodes.

Electrode voltage

For level control relays, this is the nominal voltage between electrodes. Note: this voltage is an alternating voltage, so as to avoid the effects of electrolytic corrosion.

Electrode current

For level control relays, this is the nominal (AC) electrode current.

Max. sensitivity

For level control relays: the maximum sensitivity is the maximum resistance between the electrodes that will be recognised as indicating the presence of liquid. This may be fixed, or adjustable over a range - according to type.

Sensitivity, fixed or adjustable

The resistance value between the electrodes B1-B3 and B2-B3 is used to determine if there is a conductive liquid between the electrodes. The sensitivity is either a fixed level (type 72.11) or an adjustable value (type 72.01). The latter is useful for "tuning out" any false detection of the fluid level arising from detecting surface foam (or head), rather than the liquid itself.

Positive safety logic

Positive logic means that the make contact is closed, if the level or parameter which is being monitored lies within the target range. The make contact opens, after a delay if appropriate, if the level falls outside of the target range, or level.

Timers

Specified time range

The minimum and maximum limits of, one or more time ranges, over which it is possible to set the desired time.

Repeatability

The difference between the upper and lower limits of a range of values taken from several time measurements of a specified time relay under identical stated conditions. Usually repeatability is indicated as a percentage of the mean value of all measured values.

Recovery time

The minimum time necessary before re-starting the timer function - in order to maintain the defined timing accuracy.

Minimum control impulse

The minimum duration of a control impulse (Terminal B1) necessary to ensure the complete and proper time function.

Setting accuracy

The difference between the measured value of the specified time and the reference value set on the scale.

Light dependent relays

Threshold setting

The ambient light level setting, measured in lux (lx), at which the output relay switches on (following the elapse of the ON Delay time). This is adjustable over the range specified in the specification.

The relay will switch off, dependent upon the type of Light dependent relay used, at either the same or a higher brightness value (following the elapse of the OFF Delay time).

Delay time

Switching ON/OFF For light-dependent relays this is an intentional delay in the response of the output relay, following a change of state within the electronic light sensitive circuit (usually indicated by change of state of an LED).

This is to eliminate the possibility of the output relay unnecessarily responding to a momentary change in ambient light level.

Time switches

1 or 2 pole output types

The 2 pole output type (12.22) can have both contacts programmed independently of each other.

Type of time switch

Daily The programmed operational sequence of the time switch repeats itself daily.

Weekly The programmed operational sequence of the time switch repeats itself weekly.

Programs

For electronic digital time switches, this is the maximum number of switching times that can be stored in memory. A switching time can be used for more than one day (ie. It could apply to Mon, Tues, Wed, Thurs and Friday), but will only use one memory location.

For mechanical daily time switches, this is the maximum number of switching points during the day that can be set.

Minimum interval setting

For time switches, this it is the minimum time interval that can be programmed.

Power back-up

The time, following a power failure, over which the time switch will retain the stored programs and the elapsed time information.

Step relays and staircase timers

Minimum/Maximum impulse duration

For step relays there is a minimum and a maximum time period for coil energisation. The former is necessary to ensure a full and complete mechanical step action, while exceeding the latter would result in coil overheating and damage.

With the electronic staircase timer, there is no limit to the maximum time for impulse duration.

Max. number of illuminated push-buttons

For step relays and staircase switches, this is the maximum number of illuminated push-buttons (having current absorption < 1 mA @ 230 V AC) that can be connected without causing problems. If the push-button consumption is higher than 1 mA, the maximum number of push-buttons allowed is proportionally reduced. (i.e. 15 push-buttons x 1 mA is equivalent to 10 push-buttons x 1.5 mA).

Glow wire conformity according to EN 60335-1

European standard EN 60335-1:2002, "Household and similar electrical appliances - Safety - Part 1: General requirements"; Paragraph 30.2.3 prescribes that insulated parts supporting connections that carry current exceeding 0.2 A (and the insulated parts within a distance of 3 mm from them), must comply with the following 2 requirements with respect to resistance to fire:

- 1 - GWFI (Glow Wire Flammability Index) of 850 °C - Compliance with glow wire flammability test at 850 °C (according to EN 60695-2-12: 2001).
- 2 - GWIT (Glow Wire Ignition Temperature) of 775 °C according to EN 60695-2-13:2001 - This requirement can be verified with a GWT (Glow Wire Test according to EN 60695-2-11: 2001) at a value of 750 °C with a flame extinction within 2 seconds.

The following Finder products comply with the above mentioned requirements:

- electromechanical relays of series **34, 40, 41, 43, 44, 45, 46, 50, 55, 56, 60, 62, 65, 66, 67**;
- PCB socket types **93.11, 95.13.2, 95.15.2, 95.23**.

Important note: Whilst EN 60335-1 permits the application of an alternative needle flame test (if the flame during test no. 2 burns longer than 2 seconds) this can result in some limitation in the relay's mounting position. Finder products however, have no such limitations, since the materials used do not require the alternative test method to be performed.

EMC (ElectroMagnetic Compatibility) Standards

Type of test	Reference standard
Electrostatic discharge	EN 61000-4-2
Radio-frequency electromagnetic field (80 ÷ 1000 MHz)	EN 61000-4-3
Fast transients (burst) (5-50 ns, 5 kHz)	EN 61000-4-4
Surges (1.2/50 µs)	EN 61000-4-5
Radio-frequency common mode disturbances (0.15 ÷ 80 MHz)	EN 61000-4-6
Power-frequency magnetic field (50 Hz)	EN 61000-4-8
Radiated and conducted emission	EN 55011/55014/55022

In panel installations, the most frequent and, particularly, more dangerous type of electrical disturbances are the following:

Burst (fast transients)

These are packets of **5/50 ns** pulses, having high peak voltage level but low energy since individual pulses are very short - 5 ns rise time (5×10^{-9} seconds) and 50 ns fall time.

They simulate the disturbances that can spread along the cables as a consequence of commutation transients from relays, contactors or motors. Usually they are not destructive, but they can affect the correct working of electronic devices.

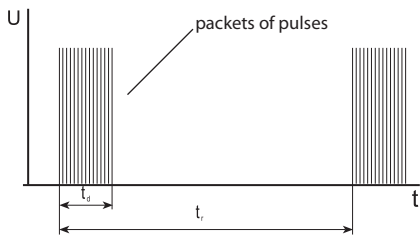
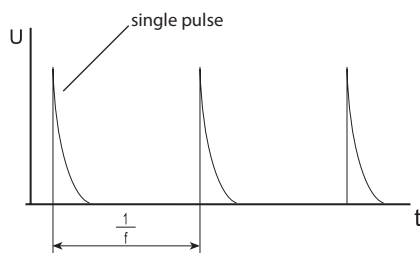
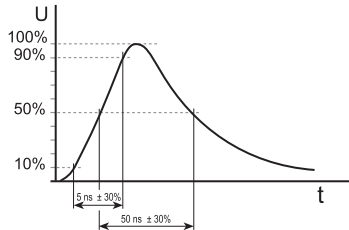

Surge (voltage pulses)

These are single **1.2/50 µs** pulses, with energy much higher than bursts since the duration is considerably longer - 1.2 µs rise time (1.2×10^{-6} seconds) and 50 µs fall time.

For this reason they are very often destructive. The Surge test typically simulates disturbances caused by the propagation of atmospheric electrical storm discharges along electrical lines, but often the switching of power contacts (such as the opening of highly inductive loads) can cause disturbances that are very similar, and equally destructive. The test levels V (peak values of the single pulses) are prescribed in appropriate product standards:

- **EN 61812-1** for electronic timers;
- **EN 60669-2-1** for electronic relays and switches;

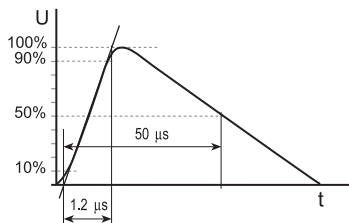

- **EN 61000-6-2** (generic standard for immunity in the industrial environment) for other electronic products for industrial application;
- **EN 61000-6-1** (generic standard for immunity in the domestic environment) for other electronic products for domestic application.

Finder electronic products are in accordance with European EMC Directive **2004/108/EC** and indeed, have immunity capabilities often higher than the levels prescribed in the above mentioned standards. Nevertheless, it is not impossible that some working environments may impose levels of disturbances far in excess of the guaranteed levels, such that the product could be immediately destroyed!

It is therefore necessary to consider Finder products as not being indestructible under all circumstances. The user should pay attention to the disturbances in electrical systems and reduce as much as possible these disturbances. For example, employ arc suppression circuits on the contacts of switches, relays or contactors which otherwise might produce over-voltages when opening electrical circuits (particularly highly inductive or DC loads). Attention should also be paid to the placement of components and cables in such a way as to limit disturbances and their propagation.

EMC rules

Require that it is the equipment designer who must ensure that the emissions from panels or equipment does not exceed the limits stated in EN 61000-6-3 (generic standard for emission in the domestic environment) or 61000-6-4 (generic standard for emission in the industrial environment) or any product specific harmonised EMC standard.

Reliability (MTTF & MTBF for equipment)

MTTF

Mean Time To Failure: the predominant failure mode for elementary relays is attributable to the wear-out mechanism affecting the relay's contacts. This can be expressed in terms of MCTF (Mean Cycles To Failure). With knowledge of the frequency of operation (cycling rate) of the relay within the equipment, the number of cycles can be simply transformed into a respective time, giving the effective MTTF value for the relay in that application. See B₁₀ description below for information on how to estimate the MCTF for Finder relays.

MTBF

Mean Time Between Failures Relays: are generally considered to be non-repairable items and consequently would require replacement following failure. Consequently, if a worn relay within equipment were replaced, its MTTF value would be appropriate in calculating the MTBF (Mean Time Between Failure) for the equipment.

B₁₀ - Statistical 10% fractile of lifetime

The electrical contact life for a Finder relay, as indicated by its associated "F" chart, can be taken as the relay's B₁₀ statistical life figure. This being the expected time at which 10% of the population will fail. There is a relationship between it and the MCTF value, and generally for a Finder relay this is approximately MCTF = 1.4 x B₁₀. See Electrical life "F-chart" section for more information.

The RoHS & WEEE directives

Recent directives approved by the European Union aim to reduce potentially hazardous substances contained in electrical and electronic equipment - minimising risks to health and the environment, and guaranteeing the safe reuse, recycling or ultimate disposal of equipment.

RoHS Directive

As of 1 July 2006, European directive 2002/95/CE dated 27 January 2003 (known as the RoHS directive - "Restriction of Hazardous Substances") and its amendments 2005/618/EC, 2005/717/EC, 2005/747/EC limits the use of substances, considered potentially damaging to human health if contained in electrical and electronic equipment. Restricted materials:

- **Lead**
- **Mercury**
- **Hexavalent chromium**
- **PBB** (Polybromide biphenyl)
- **PBDE** (Polybromide diphenyl ether)
- **Cadmium** (With certain exceptions, including contact materials)

Scope of applications subject to the RoHS & WEEE directives

Categories of electrical and electronic equipment covered by the directives

- Large household appliances
- Small household appliances
- IT and telecommunications equipment

- Consumer equipment
- Lighting equipment
- Electrical and electronic tools
(with the exception of large-scale stationary industrial tools)
- Toys, leisure and sports equipment
- Automatic dispensers
- (WEEE only) Medical devices
(with the exception of all implanted and infected products)
- (WEEE only) Monitoring and control instruments
(for example control panels)

Conformance of Finder products to the RoHS directive

Following a transitional period from December 2004 to June 2006, all Finder products manufactured since the latter date are fully RoHS compliant.

CADMIUM

Following the European Commission decision 2005/747/EC dated 21st October 2005, cadmium and its compounds are now permitted in electrical contacts. Consequently, relays with AgCdO contacts are acceptable in all applications. However, if required, the majority of Finder relays are currently available in "Cadmium-free" versions (for example, AgNi or AgSnO₂). But, it should be noted that AgCdO achieves a particularly good balance between the electrical life and the switching capacity of, for example, solenoids and inductive loads in general (particularly DC loads), motor loads and higher power resistive loads.

Alternative materials such as AgNi and AgSnO₂, do not always offer the same performance for electrical life as AgCdO, although this depends on both the type of load and application (see Table 5 under Contact specification section).

WEEE directive

European directive 2002/96/CE dated 27 January 2003 (known as the WEEE directive - "Waste Electrical and Electronic Equipment") contains measures and strategies for the safe and environmentally sound disposal of waste derived from electrical equipment. (This directive is not directly applicable to Finder products as it applies to equipment, rather than components).

S I L and P L categories

S I L and P L categories relate to the statistical reliability of Safety Related Electrical Control Systems (SRECS), and not directly to components, such as relays, used in such systems.

It is therefore not possible, or appropriate, to quote a PL or SIL class against a relay. SIL and PL categories relate only to the SRECS and can only be calculated by the system designer.

However, the following section may be useful for those engineers incorporating Finder relays into SRECS systems.

S I L Classes - according to EN 61508

EN 61508:2 describes the requirements for security of Safety Related Electrical/electronic/programmable Control Systems (SRECS). It is a "sector independent" wide ranging standard - describing some 350 Aspects that need to be considered in order to define the safety and performance required from such as system.

The S I L (Safety Integrity Level) classifies, as one of 4 classes (SIL 0 to SIL 3), the dangers and risks that would be consequential to a particular application malfunctioning. This in turn generates the need for any associated SRECS to perform with an appropriate level of reliability.

Applications, where the consequences of a failure of the control system are assessed as low (SIL 0) can tolerate a relatively high statistical probability of a control system failure occurring.

Conversely, applications where the dangerous consequences of a failure of the control system are assessed as very high (SIL 3) cannot tolerate anything other than a control system with the highest (statistically assured) reliability.

The reliability of the (overall) control system is specified in terms of the „Statistical probability of a dangerous system failure per hour“.

Note: EN 61508 is not a prescribed standard under the EU Machinery

Directive because it is primarily intended for complex systems such as chemical plants and power stations, or for use as a generic standard for other applications.

P L Classes - according to EN 13849-1

EN 13849-1 is specifically intended to cover machines and process plant. Similar to EN 61508, this standard, classifies the danger and risks into one of five PL (Performance Level) classes. Described against each class is the required reliability for the (overall) control system, defined in terms of "statistical probability of a dangerous system failure per hour".

Points of commonality between EN 61508 and EN 13849-1

The numeric values for the "statistical probability of a dangerous fault per hour" are to a large extent the same for EN 61508 And EN 13849-1.

SIL 1 corresponds to PL B & C, SIL 2 corresponds to PL D and SIL 3 corresponds to PL E.

Both EU standards define the statistical probability of a SERCS failure, and not the failure of a component. It is the responsibility of the system designer to ensure that a failure of a component does not compromise the required safety integrity of the system.

IEC EN 61508 (Safety Integrity Level)	"Statistical probability of a dangerous system failure per hour"	EN 13849-1 (Performance Level)
No special safety requirements	$\geq 10^{-5} \dots < 10^{-4}$	A
1	$\geq 3 \times 10^{-6} \dots < 10^{-5}$	B
	$\geq 10^{-6} \dots < 3 \times 10^{-6}$	C
2	$\geq 10^{-7} \dots < 10^{-6}$	D
3	$\geq 10^{-8} \dots < 10^{-7}$	E

Component reliability

The safety control system designer needs to take into account the reliability of components. Accordingly, the most predictable failure for a relay is contact wear-out at moderate to high contact loading. But, as relay reliability standard EN 61810-2:2005 emphasises, relays are not repairable, and this in particular needs to be taken into account when estimating the "statistical probability of a dangerous system failure per hour". See Reliability section.

Summary

- S I L and P L categorisation applies to systems and not to components.
- PL classes apply to machines and process plant, while SIL classes relate to more complex systems.
- EN 13849, with PL classifications, is expected to take effect from 2009 and will be mandatory, and as a consequence, component manufacturers will need to provide reliability data.
- For relays, the number of switching cycles before failure is predominantly determined by the life of the contacts, and consequently is dependent upon contact loading. The F-diagrams in the Finder catalogue can be regarded as indicating the B₁₀ Value of a Weibull type distribution of electrical life (for a 230 V AC1 load); from which the MCTF can be derived and used ultimately in calculating the "statistical probability of a dangerous system failure per hour" for the safety control system.

Certifications and Quality Approvals

		CE	EU	
		ATEX	EU	
	Asociación de Normalización y Certificación, A.C.	ANCE	Mexico	
	China quality Certification Centre	CCC	China	
	Canadian Standards Association	CSA	Canada	
	EurAsian Conformity	EAC	Russia, Belarus, Kazakhstan, Armenia and Kyrgyzstan	
	European Norms Electrical Certification	ENEC	Europe	
	Electrotechnical Testing Institute	EZU	Czech Republic	
	Germanischer Lloyd's	GL	Germany	
	Istituto Italiano del Marchio di Qualità	IMQ	Italy	
	Laboratoire Central des Industries Electriques	LCIE	France	
	Lloyd's Register of Shipping	Lloyd's Register	United Kingdom	
	Registro Italiano Navale	RINA	Italy	
	TÜV Rheinland	TUV	Germany	
	Underwriters Laboratoires	UL	USA	
	Underwriters Laboratoires	UL	USA Canada	
	VDE Prüf- und Zertifizierungsinstitut Zeichengenehmigung	VDE	Germany	